

Frequency Inverter

CFW-11 V6.0X

Programming Manual

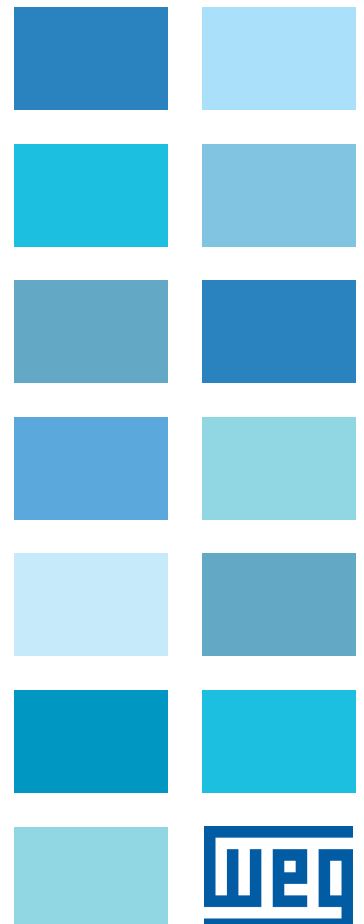
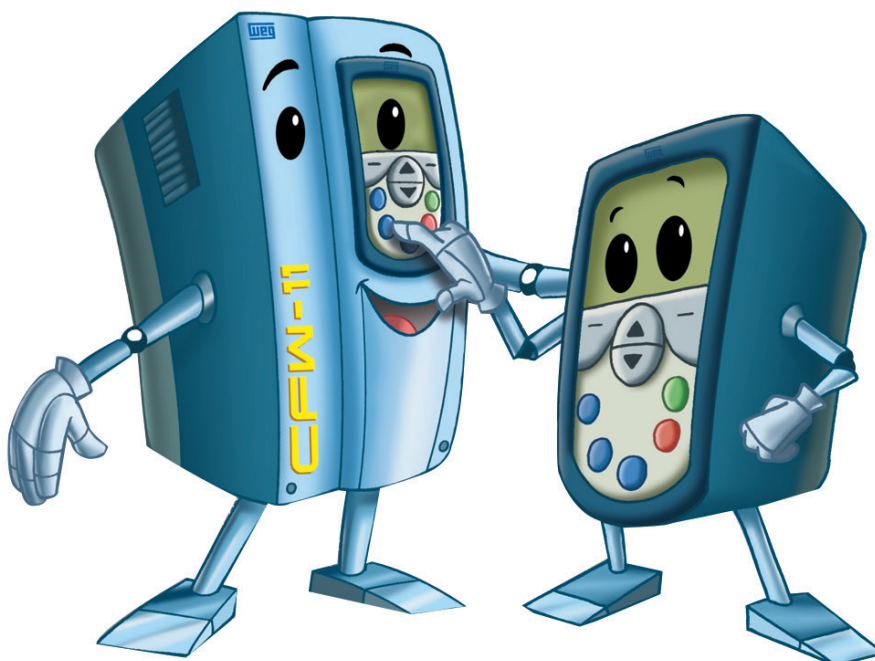

CFW-11 V6.0X PROGRAMMING MANUAL ERRATA

INTRODUCTION

The information in this manual is fully valid for version V6.00. This errata replaces the existing information in this programming manual for version V6.54.

CHANGES FOR VERSION V6.54

- The maximum value of parameters P0005 and P0094 changed from 1020.0 Hz to 599.0 Hz.

Parameter	Function	Adjustable Range	Factory Setting	User Setting	Properties	Groups
P0005	Motor Frequency	0.0 to 599.0 Hz	-		RO	09
P0094	Frequency Last Fault	0.0 to 599.0 Hz	-		RO	08

- Fault F421 – Maximum Output Frequency Exceeded was created.

Fault/Alarm	Description	Possible Causes
F421 Maximum Output Frequency Exceeded	Fault related to output frequency limitation at 599 Hz. It occurs if the output frequency exceeds 599 Hz for 3 s	■ Inverter output frequency greater than 599 Hz

- **NOTE!** of parameter P0134 was changed to:



NOTE!

The maximum speed considered by the inverter is limited to the value defined by $3.4 \times P0402$. P0134 is always the reference limit of the maximum speed, even if the value configured in P0133 is greater than the value of P0134. In addition to this limitation, there is also fault F421 that limits parameter P0134 to not exceed the value equivalent to an output frequency corresponding to 599.0 Hz.



Programming Manual

Series: CFW-11

Language: English

Document: 0899.5620 / 09

Software Version: 6.0X

Publication Date: 11/2019

Summary of Reviews

The table below describes all reviews made to this manual.

Version	Review	Description
V1.1X	R00	First edition
V1.3X	R01 and R02	General review
V2.0X	R03	General review
V3.1X	R04 and R05	General review
V5.7X	R06, R07 and R08	General review
V6.0X	R09	New software version V6.0X Inclusion of new parameters: P0174, P0177 and P0362 Energy saving function for scalar and vector control implemented in this version

QUICK PARAMETER REFERENCE, FAULTS AND ALARMS	0-1
1 SAFETY INSTRUCTIONS	1-1
1.1 SAFETY WARNINGS IN THIS MANUAL.....	1-1
1.2 SAFETY WARNINGS ON THE PRODUCT.....	1-1
1.3 PRELIMINARY RECOMMENDATIONS.....	1-2
2 GENERAL INFORMATION	2-1
2.1 ABOUT THIS MANUAL.....	2-1
2.2 TERMINOLOGY AND DEFINITIONS.....	2-1
2.2.1 Terms and Definitions Used in the Manual.....	2-1
2.2.2 Numerical Representation.....	2-3
2.2.3 Symbols for the Parameter Properties Description.....	2-3
3 ABOUT THE CFW-11	3-1
3.1 ABOUT THE CFW-11.....	3-1
4 KEYPAD (HMI)	4-1
4.1 KEYPAD (HMI).....	4-1
5 PROGRAMMING BASIC INSTRUCTIONS	5-1
5.1 PARAMETER STRUCTURE.....	5-1
5.2 GROUPS ACCESSED IN THE OPTION MENU IN THE MONITORING MODE.....	5-2
5.3 PASSWORD SETTING IN P0000.....	5-3
5.4 HMI [30].....	5-4
5.5 DATE AND TIME SETTING.....	5-9
5.6 DISPLAY INDICATIONS IN THE MONITORING MODE SETTINGS.....	5-10
5.7 INCOMPATIBILITY BETWEEN PARAMETERS.....	5-12
6 INVERTER MODEL AND ACCESSORIES IDENTIFICATION	6-1
6.1 INVERTER DATA [42].....	6-2
7 STARTING-UP AND SETTINGS	7-1
7.1 BACKUP PARAMETERS [06].....	7-1
8 AVAILABLE CONTROL TYPES	8-1
8.1 CONTROL TYPES.....	8-1
9 SCALAR CONTROL (V/F)	9-1
9.1 V/F CONTROL [23].....	9-2
9.2 ADJUSTABLE V/F CURVE [24].....	9-6
9.3 V/F CURRENT LIMITATION [26].....	9-7
9.4 V/F DC VOLTAGE LIMITATION [27].....	9-10
9.5 ENERGY SAVING FUNCTION.....	9-14
9.6 TART-UP IN THE V/F CONTROL MODE.....	9-17

10 VVW CONTROL.....	10-1
10.1 VVW CONTROL [25]	10-3
10.2 MOTOR DATA [43]	10-3
10.3 VVW CONTROL MODE START-UP.....	10-5
11 VECTOR CONTROL.....	11-1
11.1 SENSORLESS CONTROL AND WITH ENCODER	11-1
11.2 I/F MODE (SENSORLESS).....	11-5
11.3 SELF-TUNING	11-5
11.4 OPTIMAL FLUX FOR SENSORLESS VECTOR CONTROL	11-6
11.5 TORQUE CONTROL	11-7
11.6 OPTIMAL BRAKING	11-8
11.7 MOTOR DATA [43]	11-10
11.7.1 Adjustment of the Parameters P0409 to P0412 Based on the Motor Data Sheet	11-15
11.8 VECTOR CONTROL [29]	11-17
11.8.1 Speed Regulator [90].....	11-17
11.8.2 Current Regulator [91]	11-19
11.8.3 Flux Regulator [92].....	11-20
11.8.4 I/f Control [93]	11-23
11.8.5 Self-Tuning [05] and [94].....	11-24
11.8.6 Torque Current Limitation [95]	11-29
11.8.7 DC Link Regulator [96]	11-30
11.9 START-UP IN THE VECTOR MODES SENSORLESS AND WITH ENCODER	11-32
12 FUNCTIONS COMMON TO ALL THE CONTROL MODES.....	12-1
12.1 RAMPS [20]	12-1
12.2 SPEED REFERENCES [21]	12-3
12.3 SPEED LIMITS [22]	12-5
12.4 MULTISPEED [36]	12-7
12.5 ELECTRONIC POTENTIOMETER [37].....	12-9
12.6 ZERO SPEED LOGIC [35]	12-10
12.7 FLYING START/RIDE-THROUGH [44]	12-11
12.7.1 V/f Flying Start and VVW	12-12
12.7.2 Vector Flying Start	12-12
12.7.2.1 P0202 = 3	12-12
12.7.2.2 P0202 = 4	12-15
12.7.3 V/f, VVW and Ride-Through	12-15
12.7.4 Vector Ride-Through.....	12-16
12.8 DC BRAKING [47]	12-19
12.9 SKIP SPEED [48]	12-23
12.10 SEARCH OF ZERO OF THE ENCODER	12-24

13 DIGITAL AND ANALOG INPUTS AND OUTPUTS	13-1
13.1 I/O CONFIGURATION [07]	13-1
13.1.1 Analog Inputs [38]	13-1
13.1.2 Analog Outputs [39].....	13-6
13.1.3 Digital Inputs [40]	13-12
13.1.4 Digital Outputs / Relays [41]	13-20
13.2 LOCAL AND REMOTE COMMAND.....	13-33
13.3 3-WIRE COMMAND [33]	13-38
13.4 FORWARD RUN/REVERSE RUN COMMANDS [34].....	13-38
14 DYNAMIC BRAKING	14-1
14.1 DYNAMIC BRAKING [28].....	14-1
15 FAULTS AND ALARMS.....	15-1
15.1 MOTOR OVERLOAD PROTECTION	15-1
15.2 MOTOR OVERTEMPERATURE PROTECTION	15-2
15.3 PROTECTIONS [45]	15-4
15.4 MOTOR OVERTEMPERATURE PROTECTION USING THE IOE-01, IOE-02 OR IOE-03 MODULE	15-19
15.4.1 PTC Type Temperature Sensor	15-20
15.4.2 PT100 or KTY84 Temperature Sensor Type.....	15-20
16 READ ONLY PARAMETERS [09]	16-1
16.1 FAULT HISTORY [08]	16-10
17 COMMUNICATION [49]	17-1
17.1 RS-232 AND RS-485 SERIAL INTERFACE	17-1
17.2 CAN INTERFACE – CANOPEN/DEVICENET	17-1
17.3 ANYBUS-CC INTERFACE	17-2
17.4 PROFIBUS DP INTERFACE.....	17-4
17.5 COMMUNICATION STATES AND COMMANDS	17-5
18 SOFTPLC [50]	18-1
18.1 SOFTPLC	18-1
18.2 I/O CONFIGURATION [07]	18-1
18.2.1 Digital Inputs [40]	18-1
18.2.2 Digital Outputs [41].....	18-2
19 TRACE FUNCTION [52].....	19-1
19.1 TRACE FUNCTION	19-1

20 PID REGULATOR [46]	20-1
20.1 DESCRIPTION AND DEFINITIONS	20-1
20.2 COMMISSIONING.....	20-3
20.3 SLEEP MODE	20-8
20.4 MONITORING MODE SCREENS	20-8
20.5 CONNECTION OF A 2-WIRE TRANSDUCER.....	20-9
20.6 PARAMETERS.....	20-9
20.7 ACADEMIC PID	20-16
21 PM VECTOR CONTROL	21-1
21.1 PERMANENT MAGNET SYNCHRONOUS MOTORS (PMSM)	21-1
21.2 SENSORLESS PM CONTROL AND PM WITH ENCODER	21-1
21.2.1 Sensorless PM - P0202 = 7	21-2
21.2.2 PM with Encoder - P0202 = 6.....	21-3
21.2.3 Modified Functions.....	21-4
21.3 PROGRAMMING BASIC INSTRUCTIONS – INCOMPATIBILITY BETWEEN PARAMETERS.....	21-4
21.4 INVERTER MODEL AND ACCESSORIES IDENTIFICATION	21-4
21.5 TORQUE CONTROL	21-4
21.6 MOTOR DATA [43] AND SELF-TUNING [05] AND [94].....	21-6
21.7 PM VECTOR CONTROL [29]	21-9
21.7.1 Speed Regulator [90].....	21-9
21.7.2 Current Regulator [91]	21-10
21.7.3 Flux Regulator [92].....	21-10
21.7.4 Torque Current Limitation [95]	21-11
21.7.5 DC Link Regulator [96]	21-12
21.7.6 Flying Start/Ride-Through [44]	21-13
21.7.7 DC Braking [47]	21-13
21.7.8 Encoder Zero Position Search	21-13
21.8 PM VECTOR CONTROL MODE START-UP.....	21-13
21.9 FAULTS AND ALARMS	21-18
21.10 READ-ONLY PARAMETERS [09]	21-18
21.11 SPEED LIMITS	21-18

QUICK PARAMETER REFERENCE, FAULTS AND ALARMS

Parameter	Function	Adjustable Range	Factory Setting	User Setting	Properties	Groups	Pag.
P0000	Access to Parameters	0 to 9999	0		-	-	5-3
P0001	Speed Reference	0 to 18000 rpm	-		RO	09	16-1
P0002	Motor Speed	0 to 18000 rpm	-		RO	09	16-1
P0003	Motor Current	0.0 to 4500.0 A	-		RO	09	16-2
P0004	DC Link Voltage (U_d)	0 to 2000 V	-		RO	09	16-2
P0005	Motor Frequency	0.0 to 1020.0 Hz	-		RO	09	16-2
P0006	VFD Status	0 = Ready 1 = Run 2 = Undervoltage 3 = Fault 4 = Self-Tuning 5 = Configuration 6 = DC-Braking 7 = STO	-		RO	09	16-2
P0007	Motor Voltage	0 to 2000 V	-		RO	09	16-3
P0009	Motor Torque	-1000.0 to 1000.0 %	-		RO	09	16-3
P0010	Output Power	0.0 to 6553.5 kW	-		RO	09	16-4
P0011	Output Cos phi	0.00 to 1.00	-		RO	09	16-5
P0012	DI8 to DI1 Status	Bit 0 = DI1 Bit 1 = DI2 Bit 2 = DI3 Bit 3 = DI4 Bit 4 = DI5 Bit 5 = DI6 Bit 6 = DI7 Bit 7 = DI8	-		RO	09, 40	16-5
P0013	DO5 to DO1 Status	Bit 0 = DO1 Bit 1 = DO2 Bit 2 = DO3 Bit 3 = DO4 Bit 4 = DO5	-		RO	09, 41	16-5
P0014	AO1 Value	0.00 to 100.00 %	-		RO	09, 39	16-5
P0015	AO2 Value	0.00 to 100.00 %	-		RO	09, 39	16-5
P0016	AO3 Value	-100.00 to 100.00 %	-		RO	09, 39	16-5
P0017	AO4 Value	-100.00 to 100.00 %	-		RO	09, 39	16-5
P0018	AI1 Value	-100.00 to 100.00 %	-		RO	09, 38, 95	16-5
P0019	AI2 Value	-100.00 to 100.00 %	-		RO	09, 38, 95	16-5
P0020	AI3 Value	-100.00 to 100.00 %	-		RO	09, 38, 95	16-5
P0021	AI4 Value	-100.00 to 100.00 %	-		RO	09, 38, 95	16-5
P0023	Software Version	0.00 to 655.35	-		RO	09, 42	16-5
P0025	DI16 to DI9 Status	Bit 0 = DI9 Bit 1 = DI10 Bit 2 = DI11 Bit 3 = DI12 Bit 4 = DI13 Bit 5 = DI14 Bit 6 = DI15 Bit 7 = DI16			RO	09, 40	18-2
P0026	DO13 to DO6 Status	Bit 0 = DO6 Bit 1 = DO7 Bit 2 = DO8 Bit 3 = DO9 Bit 4 = DO10 Bit 5 = DO11 Bit 6 = DO12 Bit 7 = DO13			RO	09, 41	18-2
P0027	Accessories Config. 1	0000h to FFFFh	-		RO	09, 42	16-5
P0028	Accessories Config. 2	0000h to FFFFh	-		RO	09, 42	16-5
P0029	Power Hardware Config	Bit 0 to 5 = Rated Current Bit 6 and 7 = Rated Voltage Bit 8 = EMC Filter Bit 9 = Safety Relay Bit 10 = (0)24V/(1)DC Link Bit 11 = DC Special Hardware Bit 12 = Dyn.Brak. IGBT Bit 13 = Special Bit 14 and 15 = Reserved	-		RO	09, 42	16-5

Quick Parameter Reference, Faults and Alarms

0

Parameter	Function	Adjustable Range	Factory Setting	User Setting	Properties	Groups	Pag.
P0030	IGBTs Temperature U	-20.0 to 150.0 °C	-		RO	09, 45	16-6
P0031	IGBTs Temperature V	-20.0 to 150.0 °C	-		RO	09, 45	16-6
P0032	IGBTs Temperature W	-20.0 to 150.0 °C	-		RO	09, 45	16-6
P0033	Rectifier Temperature	-20.0 to 150.0 °C	-		RO	09, 45	16-6
P0034	Internal Air Temp.	-20.0 to 150.0 °C	-		RO	09, 45	16-6
P0035	Control Air Temperature	-20.0 to 150.0 °C	-		RO	09, 45	16-6
P0036	Fan Heatsink Speed	0 to 15000 rpm	-		RO	09	16-6
P0037	Motor Overload Status	0 to 100 %	-		RO	09	16-7
P0038	Encoder Speed	0 to 65535 rpm	-		RO	09	16-7
P0039	Encoder Pulses Count	0 to 40000	-		RO	09	16-7
P0040	PID Process Variable	0.0 to 100.0 %	-		RO	09, 46	16-8
P0041	PID Setpoint Value	0.0 to 100.0 %	-		RO	09, 46	16-8
P0042	Time Powered	0 to 65535 h	-		RO	09	16-8
P0043	Time Enabled	0.0 to 6553.5 h	-		RO	09	16-8
P0044	kWh Output Energy	0 to 65535 kWh	-		RO	09	16-8
P0045	Fan Enabled Time	0 to 65535 h	-		RO	09	16-9
P0048	Present Alarm	0 to 999	-		RO	09	16-9
P0049	Present Fault	0 to 999	-		RO	09	16-9
P0050	Last Fault	0 to 999	-		RO	08	16-11
P0051	Last Fault Day/Month	00/00 to 31/12	-		RO	08	16-11
P0052	Last Fault Year	00 to 99	-		RO	08	16-12
P0053	Last Fault Time	00:00 to 23:59	-		RO	08	16-13
P0054	Second Fault	0 to 999	-		RO	08	16-11
P0055	Second Flt. Day/Month	00/00 to 31/12	-		RO	08	16-11
P0056	Second Fault Year	00 to 99	-		RO	08	16-12
P0057	Second Fault Time	00:00 to 23:59	-		RO	08	16-13
P0058	Third Fault	0 to 999	-		RO	08	16-11
P0059	Third Fault Day/Month	00/00 to 31/12	-		RO	08	16-11
P0060	Third Fault Year	00 to 99	-		RO	08	16-12
P0061	Third Fault Time	00:00 to 23:59	-		RO	08	16-13
P0062	Fourth Fault	0 to 999	-		RO	08	16-11
P0063	Fourth Flt. Day/Month	00/00 to 31/12	-		RO	08	16-11
P0064	Fourth Fault Year	00 to 99	-		RO	08	16-12
P0065	Fourth Fault Time	00:00 to 23:59	-		RO	08	16-13
P0066	Fifth Fault	0 to 999	-		RO	08	16-11
P0067	Fifth Fault Day/Month	00/00 to 31/12	-		RO	08	16-11
P0068	Fifth Fault Year	00 to 99	-		RO	08	16-12
P0069	Fifth Fault Time	00:00 to 23:59	-		RO	08	16-13
P0070	Sixth Fault	0 to 999	-		RO	08	16-11
P0071	Sixth Fault Day/Month	00/00 to 31/12	-		RO	08	16-11
P0072	Sixth Fault Year	00 to 99	-		RO	08	16-12
P0073	Sixth Fault Time	00:00 to 23:59	-		RO	08	16-13
P0074	Seventh Fault	0 to 999	-		RO	08	16-11
P0075	Seventh Flt.Day/Month	00/00 to 31/12	-		RO	08	16-11
P0076	Seventh Fault Year	00 to 99	-		RO	08	16-12
P0077	Seventh Fault Time	00:00 to 23:59	-		RO	08	16-13
P0078	Eighth Fault	0 to 999	-		RO	08	16-11
P0079	Eighth Flt. Day/Month	00/00 to 31/12	-		RO	08	16-11
P0080	Eighth Fault Year	00 to 99	-		RO	08	16-12
P0081	Eighth Fault Time	00:00 to 23:59	-		RO	08	16-13
P0082	Ninth Fault	0 to 999	-		RO	08	16-11
P0083	Ninth Fault Day/Month	00/00 to 31/12	-		RO	08	16-12
P0084	Ninth Fault Year	00 to 99	-		RO	08	16-12
P0085	Ninth Fault Time	00:00 to 23:59	-		RO	08	16-13
P0086	Tenth Fault	0 to 999	-		RO	08	16-11
P0087	Tenth Fault Day/Month	00/00 to 31/12	-		RO	08	16-12
P0088	Tenth Fault Year	00 to 99	-		RO	08	16-12
P0089	Tenth Fault Time	00:00 to 23:59	-		RO	08	16-13
P0090	Current At Last Fault	0.0 to 4500.0 A	-		RO	08	16-13
P0091	DC Link At Last Fault	0 to 2000 V	-		RO	08	16-14

Parameter	Function	Adjustable Range	Factory Setting	User Setting	Properties	Groups	Pag.
P0092	Speed At Last Fault	0 to 18000 rpm	-		RO	08	16-14
P0093	Reference Last Fault	0 to 18000 rpm	-		RO	08	16-14
P0094	Frequency Last Fault	0.0 to 1020.0 Hz	-		RO	08	16-14
P0095	Motor Volt.Last Fault	0 to 2000 V	-		RO	08	16-15
P0096	Dlx Status Last Fault	Bit 0 = DI1 Bit 1 = DI2 Bit 2 = DI3 Bit 3 = DI4 Bit 4 = DI5 Bit 5 = DI6 Bit 6 = DI7 Bit 7 = DI8	-		RO	08	16-15
P0097	DOx Status Last Fault	Bit 0 = DO1 Bit 1 = DO2 Bit 2 = DO3 Bit 3 = DO4 Bit 4 = DO5	-		RO	08	16-15
P0100	Acceleration Time	0.0 to 999.0 s	20.0 s		-	04, 20	12-1
P0101	Deceleration Time	0.0 to 999.0 s	20.0 s		-	04, 20	12-1
P0102	Acceleration Time 2	0.0 to 999.0 s	20.0 s		-	20	12-1
P0103	Deceleration Time 2	0.0 to 999.0 s	20.0 s		-	20	12-1
P0104	S Ramp	0 = Off 1 = 50% 2 = 100%	0		-	20	12-2
P0105	1st/2nd Ramp Select.	0 = 1 st Ramp 1 = 2 nd Ramp 2 = Dlx 3 = Serial/USB 4 = Anybus-CC 5 = CANOpen/DeviceNet 6 = SoftPLC 7 = PLC11	2		CFG	20	12-3
P0120	Speed Ref. Backup	0 = Off 1 = On	1		-	21	12-3
P0121	Keypad Reference	0 to 18000 rpm	90 rpm		-	21	12-4
P0122	JOG/JOG+ Reference	0 to 18000 rpm	150 (125) rpm		-	21	12-5
P0123	JOG- Reference	0 to 18000 rpm	150 (125) rpm		PM and Vector	21	12-5
P0124	Multispeed Ref. 1	0 to 18000 rpm	90 (75) rpm		-	21, 36	12-7
P0125	Multispeed Ref. 2	0 to 18000 rpm	300 (250) rpm		-	21, 36	12-7
P0126	Multispeed Ref. 3	0 to 18000 rpm	600 (500) rpm		-	21, 36	12-7
P0127	Multispeed Ref. 4	0 to 18000 rpm	900 (750) rpm		-	21, 36	12-7
P0128	Multispeed Ref. 5	0 to 18000 rpm	1200 (1000) rpm		-	21, 36	12-7
P0129	Multispeed Ref. 6	0 to 18000 rpm	1500 (1250) rpm		-	21, 36	12-7
P0130	Multispeed Ref. 7	0 to 18000 rpm	1800 (1500) rpm		-	21, 36	12-7
P0131	Multispeed Ref. 8	0 to 18000 rpm	1650 (1375) rpm		-	21, 36	12-7
P0132	Max. Overspeed Level	0 to 100 %	10 %		CFG	22, 45	12-5
P0133	Minimum Speed	0 to 18000 rpm	90 (75) rpm		-	04, 22	12-6
P0134	Maximum Speed	0 to 18000 rpm	1800 (1500) rpm		-	04, 22	12-6
P0135	Max. Output Current	0.2 to 2xI _{nom-HD}	1.5xI _{nom-HD}		V/f and VVW	04, 26	9-8
P0136	Manual Torque Boost	0 to 9	According to inverter model		V/f	04, 23	9-2
P0137	Autom. Torque Boost	0.00 to 1.00	0.00		V/f	23	9-2
P0138	Slip Compensation	-10.0 to 10.0 %	0.0 %		V/f	23	9-3
P0139	Output Current Filter	0.0 to 16.0 s	0.2 s		V/f and VVW	23, 25	9-4
P0140	Dwell Time At Start	0.0 to 10.0 s	0.0 s		V/f and VVW	23, 25	9-5
P0141	Dwell Speed At Start	0 to 300 rpm	90 rpm		V/f and VVW	23, 25	9-5
P0142	Max. Output Voltage	0.0 to 100.0 %	100.0 %		CFG and Adj	24	9-6
P0143	Interm.Output Voltage	0.0 to 100.0 %	50.0 %		CFG and Adj	24	9-6
P0144	3Hz Output Voltage	0.0 to 100.0 %	8.0 %		CFG and Adj	24	9-6
P0145	Field Weakening Speed	0 to 18000 rpm	1800 rpm		CFG and Adj	24	9-7
P0146	Intermediate Speed	0 to 18000 rpm	900 rpm		CFG and Adj	24	9-7
P0150	DC Regul. Type V/f	0 = Ramp Hold 1 = Ramp Accel.	0		CFG, V/f and VVW	27	9-12

Quick Parameter Reference, Faults and Alarms

0

Parameter	Function	Adjustable Range	Factory Setting	User Setting	Properties	Groups	Pag.
P0151	DC Regul. Level V/f	339 to 400 V 585 to 800 V 585 to 800 V 585 to 800 V 585 to 800 V 809 to 1000 V 809 to 1000 V 924 to 1200 V 924 to 1200 V	400 V (P0296=0) 800 V (P0296=1) 800 V (P0296=2) 800 V (P0296=3) 800 V (P0296=4) 1000 V (P0296=5) 1000 V (P0296=6) 1000 V (P0296=7) 1200 V (P0296=8)		V/f and VVW	27	9-12
P0152	DC Link Regul. P Gain	0.00 to 9.99	1.50		V/f and VVW	27	9-13
P0153	Dyn. Braking Level	339 to 400 V 585 to 800 V 585 to 800 V 585 to 800 V 585 to 800 V 809 to 1000 V 809 to 1000 V 924 to 1200 V 924 to 1200 V	375 V (P0296=0) 618 V (P0296=1) 675 V (P0296=2) 748 V (P0296=3) 780 V (P0296=4) 893 V (P0296=5) 972 V (P0296=6) 972 V (P0296=7) 1174 V (P0296=8)		-	28	14-1
P0154	Dyn. Braking Resistor	0.0 to 500.0 ohm	0.0 ohm		-	28	14-2
P0155	Dyn. B. Resist. Power	0.02 to 650.00 kW	2.60 kW		-	28	14-3
P0156	Overl.Curr. 100% Speed	0.1 to 1.5 x I _{nom-ND}	1.05 x P0401		-	45	15-4
P0157	Overl.Curr. 50% Speed	0.1 to 1.5 x I _{nom-ND}	0.9 x P0401		-	45	15-4
P0158	Overl.Curr. 5% Speed	0.1 to 1.5 x I _{nom-ND}	0.65 x P0401		-	45	15-4
P0159	Motor Thermal Class	0 = Class 5 1 = Class 10 2 = Class 15 3 = Class 20 4 = Class 25 5 = Class 30 6 = Class 35 7 = Class 40 8 = Class 45	1		CFG, V/f, VVW and Vector	45	15-6
P0160	Speed Regul. Configuration	0 = Normal 1 = Saturated	0		CFG, PM and Vector	90	11-17
P0161	Speed Prop. Gain	0.0 to 63.9	7.0		PM and Vector	90	11-17
P0162	Speed Integral Gain	0.000 to 9.999	0.005		PM and Vector	90	11-17
P0163	LOC Reference Offset	-999 to 999	0		PM and Vector	90	11-18
P0164	REM Reference Offset	-999 to 999	0		PM and Vector	90	11-18
P0165	Speed Filter	0.012 to 1.000 s	0.012 s		PM and Vector	90	11-19
P0166	Speed Diff. Gain	0.00 to 7.99	0.00		PM and Vector	90	11-19
P0167	Current Prop. Gain	0.00 to 1.99	0.50		Vector	91	11-19
P0168	Current Integral Gain	0.000 to 1.999	0.010		Vector	91	11-20
P0169	Max. + Torque Curr.	0.0 to 350.0 %	125.0 %		PM and Vector	95	11-29
P0170	Max. - Torque Curr.	0.0 to 350.0 %	125.0 %		PM and Vector	95	11-29
P0174	Min. Torque Curr.	0.0 to 350.0 %	30.0 %		Sless		21-12
P0175	Flux Proport. Gain	0.0 to 31.9	2.0		Vector	92	11-20
P0176	Flux Integral Gain	0.000 to 9.999	0.020		Vector	92	11-20
P0177	Minimum Flux	0 to 120 %	30 %		Sless		11-21
P0178	Rated Flux	0 to 120 %	100 %		Vector	92	11-21
P0180	Iq* After I/f	0 to 350 %	10 %		Sless	93	11-23
P0181	Magnetization Mode	0 = General Enable 1 = Run/Stop	0		CFG and Encoder	92	11-21
P0182	Speed for I/F Activ.	0 to 300 rpm	18 rpm		Sless	93	11-23
P0183	Current in I/F Mode	0 to 9	1		Sless	93	11-23
P0184	DC Link Regul. Mode	0 = With losses 1 = Without losses 2 = Enab/Disab Dlx	1		CFG and Vector	96	11-30

Parameter	Function	Adjustable Range	Factory Setting	User Setting	Properties	Groups	Pag.
P0185	DC Link Regul. Level	339 to 400 V 585 to 800 V 585 to 800 V 585 to 800 V 809 to 1000 V 809 to 1000 V 924 to 1200 V 924 to 1200 V	400 V (P0296=0) 800 V (P0296=1) 800 V (P0296=2) 800 V (P0296=3) 800 V (P0296=4) 1000 V (P0296=5) 1000 V (P0296=6) 1000 V (P0296=7) 1200 V (P0296=8)		Vector	96	11-31
P0186	DC Link Prop. Gain	0.0 to 63.9	18.0		PM and Vector	96	11-32
P0187	DC Link Integral Gain	0.000 to 9.999	0.002		PM and Vector	96	11-32
P0188	Voltage Proport. Gain	0.000 to 7.999	0.200		Vector	92	11-22
P0189	Voltage Integral Gain	0.000 to 7.999	0.001		Vector	92	11-22
P0190	Max. Output Voltage	0 to 690 V	P0400		PM and Vector	92	11-22
P0191	Encoder Zero Search	0 = Off 1 = On	0		V/f, VVW and Vector		12-24
P0192	Status Encoder Zero Search	0 = Off 1 = Finished	0		RO, V/f, VVW and Vector		12-25
P0193	Day of the Week	0 = Sunday 1 = Monday 2 = Tuesday 3 = Wednesday 4 = Thursday 5 = Friday 6 = Saturday	0		-	30	5-4
P0194	Day	01 to 31	01		-	30	5-4
P0195	Month	01 to 12	01		-	30	5-4
P0196	Year	00 to 99	06		-	30	5-4
P0197	Hour	00 to 23	00		-	30	5-4
P0198	Minutes	00 to 59	00		-	30	5-4
P0199	Seconds	00 to 59	00		-	30	5-4
P0200	Password	0 = Off 1 = On 2 = Change Pass.	1		-	30	5-5
P0201	Language	0 = Português 1 = English 2 = Español 3 = Deutsche 4 = Français	0		-	30	5-5
P0202	Type of Control	0 = V/f 60 Hz 1 = V/f 50 Hz 2 = V/f Adjustable 3 = Sensorless 4 = Encoder 5 = VVW 6 = Encoder PM 7 = Sensorless PM	0		CFG	05, 23, 24, 25, 90, 91, 92, 93, 94, 95, 96	9-5
P0203	Special Function Sel.	0 = None 1 = PID Regulator	0		CFG	46	20-10
P0204	Load/Save Parameters	0 = Not Used 1 = Not Used 2 = Reset P0045 3 = Reset P0043 4 = Reset P0044 5 = Load 60Hz 6 = Load 50Hz 7 = Load User 1 8 = Load User 2 9 = Load User 3 10 = Save User 1 11 = Save User 2 12 = Save User 3	0		CFG	06	7-1

Quick Parameter Reference, Faults and Alarms

0

Parameter	Function	Adjustable Range	Factory Setting	User Setting	Properties	Groups	Pag.
P0205	Read Parameter Sel. 1	0 = Not selected 1 = Speed Refer. # 2 = Motor Speed # 3 = MotorCurrent # 4 = DC Link Volt # 5 = Motor Freq. # 6 = MotorVoltage # 7 = Motor Torque # 8 = Output Power # 9 = Process Var. # 10 = Setpoint PID # 11 = Speed Refer. - 12 = Motor Speed - 13 = MotorCurrent - 14 = DC Link Volt - 15 = Motor Freq. - 16 = MotorVoltage - 17 = Motor Torque - 18 = Output Power - 19 = Process Var. - 20 = Setpoint PID - 21 = SoftPLC P1010# 22 = SoftPLC P1011# 23 = SoftPLC P1012# 24 = SoftPLC P1013# 25 = SoftPLC P1014# 26 = SoftPLC P1015# 27 = SoftPLC P1016# 28 = SoftPLC P1017# 29 = SoftPLC P1018# 30 = SoftPLC P1019# 31 = PLC11 P1300 # 32 = PLC11 P1301 # 33 = PLC11 P1302 # 34 = PLC11 P1303 # 35 = PLC11 P1304 # 36 = PLC11 P1305 # 37 = PLC11 P1306 # 38 = PLC11 P1307 # 39 = PLC11 P1308 # 40 = PLC11 P1309 #	2		-	30	5-6
P0206	Read Parameter Sel. 2	See options in P0205	3		-	30	5-6
P0207	Read Parameter Sel. 3	See options in P0205	5		-	30	5-6
P0208	Ref. Scale Factor	1 to 18000	1800 (1500)		-	30	5-7
P0209	Ref. Eng. Unit 1	32 to 127	114		-	30	5-8
P0210	Ref. Eng. Unit 2	32 to 127	112		-	30	5-8
P0211	Ref. Eng. Unit 3	32 to 127	109		-	30	5-8
P0212	Ref. Decimal Point	0 = wxyz 1 = wxy.z 2 = wx.yz 3 = w.xyz	0		-	30	5-7
P0213	Full Scale Read 1	0.0 to 200.0 %	100.0 %		CFG	30	5-8
P0214	Full Scale Read 2	0.0 to 200.0 %	100.0 %		CFG	30	5-8
P0215	Full Scale Read 3	0.0 to 200.0 %	100.0 %		CFG	30	5-8
P0216	HMI Display Contrast	0 to 37	27		-	30	5-9
P0217	Zero Speed Disable	0 = Off 1 = On (N* and N) 2 = On (N*)	0		CFG	35, 46	12-10
P0218	Zero Speed Dis. Out	0 = Ref. or Speed 1 = Reference	0		-	35, 46	12-10
P0219	Zero Speed Time	0 to 999 s	0 s		-	35, 46	12-11

Parameter	Function	Adjustable Range	Factory Setting	User Setting	Properties	Groups	Pag.
P0220	LOC/REM Selection Src	0 = Always LOC 1 = Always REM 2 = LR Key LOC 3 = LR Key REM 4 = Dlx 5 = Serial/USB LOC 6 = Serial/USB REM 7 = Anybus-CC LOC 8 = Anybus-CC REM 9 = CO/DN/DP LOC 10 = CO/DN/DP REM 11 = SoftPLC LOC 12 = SoftPLC REM 13 = PLC11 LOC 14 = PLC11 REM	2		CFG	31, 32, 33, 110	13-33
P0221	LOC Reference Sel.	0 = HMI 1 = AI1 2 = AI2 3 = AI3 4 = AI4 5 = Sum Als > 0 6 = Sum Als 7 = E.P. 8 = Multispeed 9 = Serial/USB 10 = Anybus-CC 11 = CANop/DNet/DP 12 = SoftPLC 13 = PLC11	0		CFG	31, 36, 37, 38, 110	13-33
P0222	REM Reference Sel.	See options in P0221	1		CFG	32, 36, 37, 38, 110	13-33
P0223	LOC FWD/REV Selection	0 = Always FWD 1 = Always REV 2 = FR Key FWD 3 = FR Key REV 4 = Dlx 5 = Serial/USB FWD 6 = Serial/USB REV 7 = Anybus-CC FWD 8 = Anybus-CC REV 9 = CO/DN/DP FWD 10 = CO/DN/DP REV 11 = AI4 Polarity 12 = SoftPLC FWD 13 = SoftPLC REV 14 = AI2 Polarity 15 = PLC11 FWD 16 = PLC11 REV	2		CFG, V/f, VVW and Vector	31, 33, 110	13-34
P0224	LOC Run/Stop Sel.	0 = I,O Keys 1 = Dlx 2 = Serial/USB 3 = Anybus-CC 4 = CANop/DNet/DP 5 = SoftPLC 6 = PLC11	0		CFG	31, 33, 110	13-35
P0225	LOC JOG Selection	0 = Disable 1 = JOG Key 2 = Dlx 3 = Serial/USB 4 = Anybus-CC 5 = CANop/DNet/DP 6 = SoftPLC 7 = PLC11	1		CFG	31, 110	13-35
P0226	REM FWD/REV Sel.	See options in P0223	4		CFG, V/f, VVW and Vector	32, 33, 110	13-34
P0227	REM Run/Stop Sel.	See options in P0224	1		CFG	32, 33, 110	13-35
P0228	REM JOG Selection	See options in P0225	2		CFG	32, 110	13-35

Quick Parameter Reference, Faults and Alarms

0

Parameter	Function	Adjustable Range	Factory Setting	User Setting	Properties	Groups	Pag.
P0229	Stop Mode Selection	0 = Ramp to Stop 1 = Coast to Stop 2 = Fast Stop 3 = By Ramp with Iq* 4 = Fast Stop with Iq*	0		CFG	31, 32, 33, 34	13-36
P0230	Dead Zone (Als)	0 = Off 1 = On	0		-	38	13-2
P0231	AI1 Signal Function	0 = Speed Ref. 1 = N* Ramp Ref. 2 = Max.Torque Cur 3 = Process Var. 4 = PTC 5 = Not Used 6 = Not Used 7 = PLC Use	0		CFG	38, 95	13-3
P0232	AI1 Gain	0.000 to 9.999	1.000		-	38, 95	13-4
P0233	AI1 Signal Type	0 = 0 to 10 V/20 mA 1 = 4 to 20 mA 2 = 10 V/20 mA to 0 3 = 20 to 4 mA	0		CFG	38, 95	13-5
P0234	AI1 Offset	-100.00 to 100.00 %	0.00 %		-	38, 95	13-4
P0235	AI1 Filter	0.00 to 16.00 s	0.00 s		-	38, 95	13-4
P0236	AI2 Signal Function	See options in P0231	0		CFG	38, 95	13-3
P0237	AI2 Gain	0.000 to 9.999	1.000		-	38, 95	13-4
P0238	AI2 Signal Type	0 = 0 to 10 V/20 mA 1 = 4 to 20 mA 2 = 10 V/20 mA to 0 3 = 20 to 4 mA 4 = -10 to +10 V	0		CFG	38, 95	13-6
P0239	AI2 Offset	-100.00 to 100.00 %	0.00 %		-	38, 95	13-4
P0240	AI2 Filter	0.00 to 16.00 s	0.00 s		-	38, 95	13-4
P0241	AI3 Signal Function	See options in P0231	0		CFG	38, 95	13-3
P0242	AI3 Gain	0.000 to 9.999	1.000		-	38, 95	13-4
P0243	AI3 Signal Type	0 = 0 to 10 V/20 mA 1 = 4 to 20 mA 2 = 10 V/20 mA to 0 3 = 20 to 4 mA	0		CFG	38, 95	13-5
P0244	AI3 Offset	-100.00 to 100.00 %	0.00 %		-	38, 95	13-4
P0245	AI3 Filter	0.00 to 16.00 s	0.00 s		-	38, 95	13-4
P0246	AI4 Signal Function	0 = Speed Ref. 1 = N* Ramp Ref. 2 = Max.Torque Cur 3 = Process Var. 4 = Not Used 5 = Not Used 6 = Not Used 7 = PLC Use	0		CFG	38, 95	13-3
P0247	AI4 Gain	0.000 to 9.999	1.000		-	38, 95	13-4
P0248	AI4 Signal Type	0 = 0 to 10 V/20mA 1 = 4 to 20 mA 2 = 10 V/20 mA to 0 3 = 20 to 4 mA 4 = -10 to +10 V	0		CFG	38, 95	13-6
P0249	AI4 Offset	-100.00 to 100.00 %	0.00 %		-	38, 95	13-4
P0250	AI4 Filter	0.00 to 16.00 s	0.00 s		-	38, 95	13-5

Parameter	Function	Adjustable Range	Factory Setting	User Setting	Properties	Groups	Pag.
P0251	AO1 Function	0 = Speed Ref. 1 = Total Ref. 2 = Real Speed 3 = Torque Cur.Ref 4 = Torque Current 5 = Output Current 6 = Process Var. 7 = Active Current 8 = Output Power 9 = PID Setpoint 10 = Torque Cur.> 0 11 = Motor Torque 12 = SoftPLC 13 = PTC 14 = Energy Sav Flux 15 = Not Used 16 = Motor lxt 17 = Encoder Speed 18 = P0696 Value 19 = P0697 Value 20 = P0698 Value 21 = P0699 Value 22 = PLC11 23 = Id* Current	2		-	39	13-7
P0252	AO1 Gain	0.000 to 9.999	1.000		-	39	13-9
P0253	AO1 Signal Type	0 = 0 to 10 V/20 mA 1 = 4 to 20 mA 2 = 10 V/20 mA to 0 3 = 20 to 4 mA	0		CFG	39	13-11
P0254	AO2 Function	See options in P0251	5		-	39	13-7
P0255	AO2 Gain	0.000 to 9.999	1.000		-	39	13-9
P0256	AO2 Signal Type	See options in P0253	0		CFG	39	13-11

Quick Parameter Reference, Faults and Alarms

0

Parameter	Function	Adjustable Range	Factory Setting	User Setting	Properties	Groups	Pag.
P0257	AO3 Function	0 = Speed Ref. 1 = Total Ref. 2 = Real Speed 3 = Torque Cur.Ref 4 = Torque Current 5 = Output Current 6 = Process Var. 7 = Active Current 8 = Output Power 9 = PID Setpoint 10 = Torque Cur.> 0 11 = Motor Torque 12 = SoftPLC 13 = Not Used 14 = Energy Sav Flux 15 = Not Used 16 = Motor lxt 17 = Encoder Speed 18 = P0696 Value 19 = P0697 Value 20 = P0698 Value 21 = P0699 Value 22 = Not Used 23 = Id* Current 24 = Iq* Current 25 = Id Current 26 = Iq Current 27 = Isa Current 28 = Isb Current 29 = Idq Current 30 = Imr* Current 31 = Imr Current 32 = Ud Voltage 33 = Uq Voltage 34 = Flux Angle 35 = Usal_rec 36 = lxt Output 37 = Rotor speed 38 = Phi Angle 39 = Usd_rec 40 = Usq_rec 41 = Flux_a1 42 = Flux_b1 43 = Stator Speed 44 = Slip 45 = Flux reference 46 = Real Flux 47 = Igen = Reg_ud 48 = Not Used 49 = Total Curr wlt 50 = Is Current 51 = lactive 52 = sR 53 = TR 54 = PfeR 55 = Pfe 56 = Pgap 57 = TL 58 = Fslip 59 = m_nc 60 = m_AST 61 = m_ 62 = m_LINHA 63 = m_BOOST 64 = SINPHI 65 = SINPHI120 66 = Ib 67 = Ic 68 = It 69 = MOD_I 70 = ZERO_V 71 = P0676 Value	2		-	39	13-8
P0258	AO3 Gain	0.000 to 9.999	1.000		-	39	13-9

Parameter	Function	Adjustable Range	Factory Setting	User Setting	Properties	Groups	Pag.
P0259	AO3 Signal Type	0 = 0 to 20 mA 1 = 4 to 20 mA 2 = 20 to 0 mA 3 = 20 to 4 mA 4 = 0 to 10 V 5 = 10 to 0 V 6 = -10 to +10 V	4		CFG	39	13-11
P0260	AO4 Function	See options in P0257	5		-	39	13-8
P0261	AO4 Gain	0.000 to 9.999	1.000		-	39	13-9
P0262	AO4 Signal Type	See options in P0259	4		CFG	39	13-11
P0263	DI1 Function	0 = Not Used 1 = Run/Stop 2 = General Enable 3 = Fast Stop 4 = FWD Run 5 = REV Run 6 = Start 7 = Stop 8 = FWD/REV 9 = LOC/REM 10 = JOG 11 = Increase E.P. 12 = Decrease E.P. 13 = Not Used 14 = Ramp 2 15 = Speed/Torque 16 = JOG+ 17 = JOG- 18 = No Ext. Alarm 19 = No Ext. Fault 20 = Reset 21 = PLC Use 22 = Manual/Auto 23 = Not Used 24 = Disab.FlyStart 25 = DC Link Regul. 26 = Progr. Off 27 = Load User 1/2 28 = Load User 3 29 = DO2 Timer 30 = DO3 Timer 31 = Trace Function	1		CFG	20, 31, 32, 33, 34, 37, 40, 44, 46	13-13
P0264	DI2 Function	See options in P0263	8		CFG	20, 31, 32, 33, 34, 37, 40, 44, 46	13-13
P0265	DI3 Function	See options in P0263	0		CFG	20, 31, 32, 33, 34, 37, 40, 44, 45, 46	13-13
P0266	DI4 Function	0 = Not Used 1 = Run/Stop 2 = General Enable 3 = Fast Stop 4 = FWD Run 5 = REV Run 6 = Start 7 = Stop 8 = FWD/REV 9 = LOC/REM 10 = JOG 11 = Increase E.P. 12 = Decrease E.P. 13 = Multispeed 14 = Ramp 2 15 = Speed/Torque 16 = JOG+ 17 = JOG- 18 = No Ext. Alarm 19 = No Ext. Fault 20 = Reset 21 = PLC Use 22 = Manual/Auto 23 = Not Used 24 = Disab.FlyStart 25 = DC Link Regul. 26 = Progr. Off 27 = Load User 1/2 28 = Load User 3 29 = DO2 Timer 30 = DO3 Timer 31 = Trace Function	0		CFG	20, 31, 32, 33, 34, 36, 37, 40, 44, 45, 46	13-13

Quick Parameter Reference, Faults and Alarms

0

Parameter	Function	Adjustable Range	Factory Setting	User Setting	Properties	Groups	Pag.
P0267	DI5 Function	See options in P0266	10		CFG	20, 31, 32, 33, 34, 36, 37, 40, 44, 45, 46	13-13
P0268	DI6 Function	See options in P0266	14		CFG	20, 31, 32, 33, 34, 36, 37, 40, 44, 45, 46	13-13
P0269	DI7 Function	See options in P0263	0		CFG	20, 31, 32, 33, 34, 37, 40, 44, 45, 46	13-13
P0270	DI8 Function	See option in P0263	0		CFG	20, 31, 32, 33, 34, 37, 40, 44, 45, 46	13-13
P0273	Filter for Torque Current - Iq	0.00 to 9.99 s	0.00		Vector	41	13-20
P0274	Hysteresis for Torque Current - Iq	0.00 to 9.99 %	2.00		Vector	41	13-21
P0275	DO1 Function (RL1)	0 = Not Used 1 = N* > Nx 2 = N > Nx 3 = N < Ny 4 = N = N* 5 = Zero Speed 6 = Is > Ix 7 = Is < Ix 8 = Torque > Tx 9 = Torque < Tx 10 = Remote 11 = Run 12 = Ready 13 = No Fault 14 = No F070 15 = No F071 16 = No F006/21/22 17 = No F051/54/57 18 = No F072 19 = 4-20 mA OK 20 = P0695 Value 21 = Forward 22 = Proc. V. > PVx 23 = Proc. V. < PVy 24 = Ride-Through 25 = Pre-Charge OK 26 = Fault 27 = Time Enab > Hx 28 = SoftPLC 29 = Not Used 30 = N>Nx/Nt>Nx 31 = F > Fx (1) 32 = F > Fx (2) 33 = STO 34 = No F160 35 = No Alarm 36 = No Fault/ Alarm 37 = PLC11 38 = No Fault IOE 39 = No Alarm IOE 40 = No Cable IOE 41 = No A/cable IOE 42 = No F/cable IOE 43 = Torque +/- 44 = Torque -/+	13		CFG	41	13-21

Parameter	Function	Adjustable Range	Factory Setting	User Setting	Properties	Groups	Pag.
P0276	DO2 Function (RL2)	0 = Not Used 1 = N* > Nx 2 = N > Nx 3 = N < Ny 4 = N = N* 5 = Zero Speed 6 = Is > lx 7 = Is < lx 8 = Torque > Tx 9 = Torque < Tx 10 = Remote 11 = Run 12 = Ready 13 = No Fault 14 = No F070 15 = No F071 16 = No F006/21/22 17 = No F051/54/57 18 = No F072 19 = 4-20mA OK 20 = P0695 Value 21 = Forward 22 = Proc. V. > PVx 23 = Proc. V. < PVy 24 = Ride-Through 25 = Pre-Charge OK 26 = Fault 27 = Time Enab > Hx 28 = SoftPLC 29 = Timer 30 = N>Nx/Nt>Nx 31 = F > Fx (1) 32 = F > Fx (2) 33 = STO 34 = No F160 35 = No Alarm 36 = No Fault/Alarm 37 = PLC11 38 = No Fault IOE 39 = No Alarm IOE 40 = No Cable IOE 41 = No A/cable IOE 42 = No F/cable IOE 43 = Torque +/- 44 = Torque -/+	2		CFG	41	13-21
P0277	DO3 Function (RL3)	See options in P0276	1		CFG	41	13-21

Quick Parameter Reference, Faults and Alarms

0

Parameter	Function	Adjustable Range	Factory Setting	User Setting	Properties	Groups	Pag.
P0278	DO4 Function	0 = Not Used 1 = N* > Nx 2 = N > Nx 3 = N < Ny 4 = N = N* 5 = Zero Speed 6 = Is > Ix 7 = Is < Ix 8 = Torque > Tx 9 = Torque < Tx 10 = Remote 11 = Run 12 = Ready 13 = No Fault 14 = No F070 15 = No F071 16 = No F006/21/22 17 = No F051/54/57 18 = No F072 19 = 4-20mA OK 20 = P0695 Value 21 = Forward 22 = Proc. V. > PVx 23 = Proc. V. < PVy 24 = Ride-Through 25 = Pre-Charge OK 26 = Fault 27 = Time Enab > Hx 28 = SoftPLC 29 = Not Used 30 = N>Nx/Nt>Nx 31 = F > Fx (1) 32 = F > Fx (2) 33 = STO 34 = No F160 35 = No Alarm 36 = No Fault/Alarm 37 to 42 = Not Used 43 = Torque +/- 44 = Torque -/+	0		CFG	41	13-21
P0279	DO5 Function	See options in P0278	0		CFG	41	13-21
P0281	Fx Frequency	0.0 to 300.0 Hz	4.0 Hz		-	41	13-30
P0282	Fx Hysteresis	0.0 to 15.0 Hz	2.0 Hz		-	41	13-30
P0283	DO2 ON Time	0.0 to 300.0 s	0.0 s		-	41	13-30
P0284	DO2 OFF Time	0.0 to 300.0 s	0.0 s		-	41	13-30
P0285	DO3 ON Time	0.0 to 300.0 s	0.0 s		-	41	13-30
P0286	DO3 OFF Time	0.0 to 300.0 s	0.0 s		-	41	13-30
P0287	Nx/Ny Hysteresis	0 to 900 rpm	18 (15) rpm		-	41	13-31
P0288	Nx Speed	0 to 18000 rpm	120 (100) rpm		-	41	13-31
P0289	Ny Speed	0 to 18000 rpm	1800 (1500) rpm		-	41	13-31
P0290	Ix Current	0 to 2 x I _{nom-ND}	1.0 x I _{nom-ND}		-	41	13-31
P0291	Zero Speed Zone	0 to 18000 rpm	18 (15) rpm		-	35, 41, 46	13-31
P0292	N = N* Band	0 to 18000 rpm	18 (15) rpm		-	41	13-32
P0293	Tx Torque	0 to 200 %	100 %		-	41	13-32
P0294	Hx Time	0 to 6553 h	4320 h		-	41	13-32

Parameter	Function	Adjustable Range	Factory Setting	User Setting	Properties	Groups	Pag.
P0295	ND/HD VFD Rated Curr.	0 = 3.6 A / 3.6 A 1 = 5 A / 5 A 2 = 6 A / 5 A 3 = 7 A / 5.5 A 4 = 7 A / 7 A 5 = 10 A / 8 A 6 = 10 A / 10 A 7 = 13 A / 11 A 8 = 13.5 A / 11 A 9 = 16 A / 13 A 10 = 17 A / 13.5 A 11 = 24 A / 19 A 12 = 24 A / 20 A 13 = 28 A / 24 A 14 = 31 A / 25 A 15 = 33.5 A / 28 A 16 = 38 A / 33 A 17 = 45 A / 36 A 18 = 45 A / 38 A 19 = 54 A / 45 A 20 = 58.5 A / 47 A 21 = 70 A / 56 A 22 = 70.5 A / 61 A 23 = 86 A / 70 A 24 = 88 A / 73 A 25 = 105 A / 86 A 26 = 427 A / 340 A 27 = 470 A / 380 A 28 = 811 A / 646 A 29 = 893 A / 722 A 30 = 1216 A / 1216 A 31 = 1339 A / 1083 A 32 = 1622 A / 1292 A 33 = 1786 A / 1444 A 34 = 2028 A / 1615 A 35 = 2232 A / 1805 A 36 = 2 A / 2 A 37 = 640 A / 515 A 38 = 1216 A / 979 A 39 = 1824 A / 1468 A 40 = 2432 A / 1957 A 41 = 3040 A / 2446 A 42 = 600 A / 515 A 43 = 1140 A / 979 A 44 = 1710 A / 1468 A 45 = 2280 A / 1957 A 46 = 2850 A / 2446 A 47 = 105 A / 88 A 48 = 142 A / 115 A 49 = 180 A / 142 A 50 = 211 A / 180 A 51 = 242 A / 211 A 52 = 312 A / 242 A 53 = 370 A / 312 A 54 = 477 A / 370 A 55 = 515 A / 477 A 56 = 601 A / 515 A 57 = 720 A / 560 A 58 = 2.9 A / 2.7 A 59 = 4.2 A / 3.8 A 60 = 7 A / 6.5 A 61 = 8.5 A / 7 A 62 = 10 A / 9 A 63 = 11 A / 9 A 64 = 12 A / 10 A 65 = 15 A / 13 A 66 = 17 A / 17 A 67 = 20 A / 17 A 68 = 22 A / 19 A 69 = 24 A / 21 A 70 = 27 A / 22 A 71 = 30 A / 24 A 72 = 32 A / 27 A 73 = 35 A / 30 A 74 = 44 A / 36 A 75 = 46 A / 39 A 76 = 53 A / 44 A 77 = 54 A / 46 A 78 = 63 A / 53 A 79 = 73 A / 61 A 80 = 80 A / 66 A	-		RO	09, 42	6-7

Quick Parameter Reference, Faults and Alarms

0

Parameter	Function	Adjustable Range	Factory Setting	User Setting	Properties	Groups	Pag.
		81 = 100 A / 85 A 82 = 107 A / 90 A 83 = 108 A / 95 A 84 = 125 A / 107 A 85 = 130 A / 108 A 86 = 150 A / 122 A 87 = 147 A / 127 A 88 = 170 A / 150 A 89 = 195 A / 165 A 90 = 216 A / 180 A 91 = 289 A / 240 A 92 = 259 A / 225 A 93 = 315 A / 289 A 94 = 312 A / 259 A 95 = 365 A / 315 A 96 = 365 A / 312 A 97 = 435 A / 357 A 98 = 428 A / 355 A 99 = 472 A / 388 A 100 = 700 A / 515 A 101 = 1330 A / 979 A 102 = 1995 A / 1468 A 103 = 2660 A / 1957 A 104 = 3325 A / 2446 A 105 = 760 A / 600 A 106 = 760 A / 560 A 107 = 226 A / 180 A					
P0296	Line Rated Voltage	0 = 200 - 240 V 1 = 380 V 2 = 400 - 415 V 3 = 440 - 460 V 4 = 480 V 5 = 500 - 525 V 6 = 550 - 575 V 7 = 600 V 8 = 660 - 690 V	According to inverter model		CFG	42	6-9
P0297	Switching Frequency	0 = 1.25 kHz 1 = 2.5 kHz 2 = 5.0 kHz 3 = 10.0 kHz 4 = 2.0 kHz	According to inverter model		CFG	42	6-10
P0298	Application	0 = Normal Duty (ND) 1 = Heavy Duty (HD)	0		CFG	42	6-10
P0299	DC-Braking Start Time	0.0 to 15.0 s	0.0 s		V/f, VVW and Sless	47	12-20
P0300	DC-Braking Stop Time	0.0 to 15.0 s	0.0 s		V/f, VVW and Sless	47	12-20
P0301	DC-Braking Speed	0 to 450 rpm	30 rpm		V/f, VVW and Sless	47	12-22
P0302	DC-Braking Voltage	0.0 to 10.0 %	2.0 %		V/f and VVW	47	12-22
P0303	Skip Speed 1	0 to 18000 rpm	600 rpm		-	48	12-23
P0304	Skip Speed 2	0 to 18000 rpm	900 rpm		-	48	12-23
P0305	Skip Speed 3	0 to 18000 rpm	1200 rpm		-	48	12-23
P0306	Skip Band	0 to 750 rpm	0 rpm		-	48	12-23
P0308	Serial Address	1 to 247	1		CFG	113	17-1
P0310	Serial Baud Rate	0 = 9600 bits/s 1 = 19200 bits/s 2 = 38400 bits/s 3 = 57600 bits/s	0		CFG	113	17-1
P0311	Serial Bytes Config.	0 = 8 bits, no, 1 1 = 8 bits, even, 1 2 = 8 bits, odd, 1 3 = 8 bits, no, 2 4 = 8 bits, even, 2 5 = 8 bits, odd, 2	3		CFG	113	17-1
P0312	Serial Protocol	1 = TP 2 = Modbus RTU	2		CFG	113	17-1
P0313	Comm. Error Action	0 = Off 1 = Ramp Stop 2 = General Disab. 3 = Go to LOC 4 = LOC Keep Enab. 5 = Cause Fault	1		-	111	17-5
P0314	Serial Watchdog	0.0 to 999.0 s	0.0 s		CFG	113	17-1

Parameter	Function	Adjustable Range	Factory Setting	User Setting	Properties	Groups	Pag.
P0316	Serial Interf. Status	0 = Off 1 = On 2 = Watchdog Error	-		RO	09, 113	17-1
P0317	Oriented Start-up	0 = No 1 = Yes	0		CFG	02	7-3
P0318	Copy Function MemCard	0 = Off 1 = VFD → MemCard 2 = MemCard → VFD	0		CFG	06	7-3
P0319	Copy Function HMI	0 = Off 1 = VFD → HMI 2 = HMI → VFD	0		CFG	06	7-4
P0320	FlyStart/Ride-Through	0 = Off 1 = Flying Start 2 = FS / RT 3 = Ride-Through	0		CFG	44	12-11
P0321	DC Link Power Loss	178 to 282 V 308 to 616 V 308 to 616 V 308 to 616 V 308 to 616 V 425 to 737 V 425 to 737 V 486 to 885 V 486 to 885 V	252 V (P0296=0) 436 V (P0296=1) 459 V (P0296=2) 505 V (P0296=3) 551 V (P0296=4) 602 V (P0296=5) 660 V (P0296=6) 689 V (P0296=7) 792 V (P0296=8)		Vector	44	12-18
P0322	DC Link Ride-Through	178 to 282 V 308 to 616 V 308 to 616 V 308 to 616 V 308 to 616 V 425 to 737 V 425 to 737 V 486 to 885 V 486 to 885 V	245 V (P0296=0) 423 V (P0296=1) 446 V (P0296=2) 490 V (P0296=3) 535 V (P0296=4) 585 V (P0296=5) 640 V (P0296=6) 668 V (P0296=7) 768 V (P0296=8)		Vector	44	12-18
P0323	DC Link Power Back	178 to 282 V 308 to 616 V 308 to 616 V 308 to 616 V 308 to 616 V 425 to 737 V 425 to 737 V 486 to 885 V 486 to 885 V	267 V (P0296=0) 462 V (P0296=1) 486 V (P0296=2) 535 V (P0296=3) 583 V (P0296=4) 638 V (P0296=5) 699 V (P0296=6) 729 V (P0296=7) 838 V (P0296=8)		Vector	44	12-18
P0325	Ride-Through P Gain	0.0 to 63.9	22.8		PM and Vector	44	12-19
P0326	Ride-Through I Gain	0.000 to 9.999	0.128		PM and Vector	44	12-19
P0327	F.S. Current Ramp I/f	0.000 to 1.000 s	0.070 s		Sless	44	12-13
P0328	Flying Start Filter	0.000 to 1.000 s	0.085 s		Sless	44	12-13
P0329	Frequency Ramp F.S.	2.0 to 50.0	6.0		Sless	44	12-13
P0331	Voltage Ramp	0.2 to 60.0 s	2.0 s		V/f and VVW	44	12-16
P0332	Dead Time	0.1 to 10.0 s	1.0 s		V/f and VVW	44	12-16
P0340	Auto-Reset Time	0 to 3600 s	0 s			45	15-8
P0341	V/f Outp. Volt. Comp.	0 = Off 1 = On	0		CFG and V/f		15-9
P0342	Motor Unbal.Curr.Conf	0 = Off 1 = On	0		CFG and V/f	45	15-9
P0343	Ground Fault Config.	0 = Off 1 = On	1		CFG	45	15-10
P0344	Current Lim. Conf.	0 = Hold - FL ON 1 = Decel. - FL ON 2 = Hold - FL OFF 3 = Decel.- FL OFF	3		CFG, V/f and VVW	26	9-8
P0348	Motor Overload Conf.	0 = Off 1 = Fault/Alarm 2 = Fault 3 = Alarm	1		CFG	45	15-10
P0349	Ixt Alarm Level	70 to 100 %	85 %		CFG	45	15-10
P0350	IGBTs Overload Conf.	0 = F, w/ SF rd. 1 = F/A, w/ SF rd. 2 = F, no SF rd. 3 = F/A, no SF rd.	1		CFG	45	15-11

Quick Parameter Reference, Faults and Alarms

0

Parameter	Function	Adjustable Range	Factory Setting	User Setting	Properties	Groups	Pag.
P0351	Motor Overtemp. Conf.	0 = Off 1 = Fault/Alarm 2 = Fault 3 = Alarm	1		CFG	45	15-11
P0352	Fan Control Config.	0 = HS-OFF,Int-OFF 1 = HS-ON,Int-ON 2 = HS-CT,Int-CT 3 = HS-CT,Int-OFF 4 = HS-CT,Int-ON 5 = HS-ON,Int-OFF 6 = HS-ON,Int-CT 7 = HS-OFF,Int-ON 8 = HS-OFF,Int-CT 9 = HS-CT, Int-CT * 10 = HS-CT, Int-OFF * 11 = HS-CT, Int-ON * 12 = HS-ON, Int-CT * 13 = HS-OFF, Int-CT *	2		CFG	45	15-12
P0353	IGBTs/Air Overtmp.Cfg	0 = HS-F/A,Air-F/A 1 = HS-F/A, Air-F 2 = HS-F, Air-F/A 3 = HS-F, Air-F 4 = HS-F/A, Air-F/A * 5 = HS-F/A, Air-F * 6 = HS-F, Air-F/A * 7 = HS-F, Air-F *	0		CFG	45	15-13
P0354	Fan Speed Fault Config.	0 = Alarm 1 = Fault	1		CFG	45	15-14
P0355	F185 Fault Configuration	0 = Off 1 = On	1		CFG	45	15-14
P0356	Dead Time Compens.	0 = Off 1 = On	1		CFG	45	15-15
P0357	Line Phase Loss Time	0 to 60 s	3 s		-	45	15-15
P0358	Encoder Fault Config.	0 = Off 1 = F067 ON 2 = F065, F066 ON 3 = All ON	3		CFG and Encoder	45	15-16
P0359	Motor Current Stabil.	0 = Off 1 = On	0		V/f and VVW	45	15-16
P0362	Stop Engine Fail Time	0 to 999 s	20 s		V/f, VVW, Vectorial and PM		15-17
P0372	DC-Braking Curr Sless	0.0 to 90.0 %	40.0 %		Sless	47	12-22
P0373	PTC1 Type Sensor	0 = PTC Simple 1 = PTC Triple	1		CFG	45	15-20
P0374	Sensor 1 F/A Conf.	0 = Off 1 = Fault/Al./Cab. 2 = Fault/Cable 3 = Alarm/Cable 4 = Fault/Alarm 5 = Fault 6 = Alarm 7 = Alarm Cable	1		CFG	45	15-19
P0375	Temper. F/A Sensor 1	-20 to 200 °C	130 °C			45	15-20
P0376	PTC2 Type Sensor	0 = PTC Simple 1 = PTC Triple	1		CFG	45	15-20
P0377	Sensor 2 F/A Conf.	See options in P0374	1		CFG	45	15-19
P0378	Temper. F/A Sensor 2	-20 to 200 °C	130 °C			45	15-20
P0379	PTC3 Type Sensor	0 = PTC Simple 1 = PTC Triple	1		CFG	45	15-20
P0380	Sensor 3 F/A Conf.	See options in P0374	1		CFG	45	15-19
P0381	Temper. F/A Sensor 3	-20 to 200 °C	130 °C			45	15-20
P0382	PTC4 Type Sensor	0 = PTC Simple 1 = PTC Triple	1		CFG	45	15-20

Parameter	Function	Adjustable Range	Factory Setting	User Setting	Properties	Groups	Pag.
P0383	Sensor 4 F/A Conf.	0 = Off 1 = Fault/Al./Cab. 2 = Fault/Cable 3 = Alarm/Cable 4 = Fault/Alarm 5 = Fault 6 = Alarm 7 = Alarm Cable	1		CFG	45	15-19
P0384	Temper. F/A Sensor 4	-20 to 200 °C	130 °C			45	15-20
P0385	PTC5 Type Sensor	0 = PTC Simple 1 = PTC Triple	1		CFG	45	15-20
P0386	Sensor 5 F/A Conf.	See options in P0383	1		CFG	45	15-19
P0387	Temper. F/A Sensor 5	-20 to 200 °C	130 °C			45	15-20
P0388	Temperature Sensor 1	-20 to 200 °C			RO	09, 45	15-21
P0389	Temperature Sensor 2	-20 to 200 °C			RO	09, 45	15-21
P0390	Temperature Sensor 3	-20 to 200 °C			RO	09, 45	15-21
P0391	Temperature Sensor 4	-20 to 200 °C			RO	09, 45	15-21
P0392	Temperature Sensor 5	-20 to 200 °C			RO	09, 45	15-21
P0393	Highest Temp. Sens.	-20 to 200 °C			RO	09, 45	15-21
P0394	Cable Alarm Temper.	-20 to 200 °C	-20 °C				15-22
P0397	Slip Compensation	0 = Inactive 1 = Active Motorizing/ Regenerating 2 = Active Motorizing 3 = Active Regenerating	1		CFG and VWV	25	10-3
P0398	Motor Service Factor	1.00 to 1.50	1.00		CFG	05, 43, 94	10-3
P0399	Motor Rated Eff.	50.0 to 99.9 %	67.0 %		CFG and VWV	05, 43, 94	11-11
P0400	Motor Rated Voltage	0 to 690 V 0 to 690 V 0 to 690 V 0 to 690 V 0 to 690 V 0 to 690 V 0 to 690 V 0 to 690 V	220 V (P0296=0) 440 V (P0296=1) 440 V (P0296=2) 440 V (P0296=3) 440 V (P0296=4) 575 V (P0296=5) 575 V (P0296=6) 575 V (P0296=7) 690 V (P0296=8)		CFG	05, 43, 94	10-4
P0401	Motor Rated Current	0 to 1.3 x I _{nom-ND}	1.0 x I _{nom-ND}		CFG	05, 43, 94	10-4
P0402	Motor Rated Speed	0 to 18000 rpm	1750 (1458) rpm		CFG	05, 43, 94	10-4
P0403	Motor Rated Frequency	0 to 300 Hz	60 (50) Hz		CFG	05, 43, 94	10-4

Quick Parameter Reference, Faults and Alarms

0

Parameter	Function	Adjustable Range	Factory Setting	User Setting	Properties	Groups	Pag.
P0404	Motor Rated Power	0 = 0.33hp 0.25kW 1 = 0.5hp 0.37kW 2 = 0.75hp 0.55kW 3 = 1hp 0.75kW 4 = 1.5hp 1.1kW 5 = 2hp 1.5kW 6 = 3hp 2.2kW 7 = 4hp 3kW 8 = 5hp 3.7kW 9 = 5.5hp 4kW 10 = 6hp 4.5kW 11 = 7.5hp 5.5kW 12 = 10hp 7.5kW 13 = 12.5hp 9kW 14 = 15hp 11kW 15 = 20hp 15kW 16 = 25hp 18.5kW 17 = 30hp 22kW 18 = 40hp 30kW 19 = 50hp 37kW 20 = 60hp 45kW 21 = 75hp 55kW 22 = 100hp 75kW 23 = 125hp 90kW 24 = 150hp 110kW 25 = 175hp 130kW 26 = 180hp 132kW 27 = 200hp 150kW 28 = 220hp 160kW 29 = 250hp 185kW 30 = 270hp 200kW 31 = 300hp 220kW 32 = 350hp 260kW 33 = 380hp 280kW 34 = 400hp 300kW 35 = 430hp 315kW 36 = 440hp 330kW 37 = 450hp 335kW 38 = 475hp 355kW 39 = 500hp 375kW 40 = 540hp 400kW 41 = 600hp 450kW 42 = 620hp 460kW 43 = 670hp 500kW 44 = 700hp 525kW 45 = 760hp 570kW 46 = 800hp 600kW 47 = 850hp 630kW 48 = 900hp 670kW 49 = 1000hp 736kW 50 = 1100hp 810kW 51 = 1250hp 920kW 52 = 1400hp 1030kW 53 = 1500hp 1110kW 54 = 1600hp 1180kW 55 = 1800hp 1330kW 56 = 2000hp 1480kW 57 = 2300hp 1700kW 58 = 2500hp 1840kW 59 = 2900 hp 2140 kW 60 = 3400 hp 2500 kW	Motor _{max-ND}		CFG	05, 43, 94	10-4
P0405	Encoder Pulses Number	100 to 9999 ppr	1024 ppr		CFG	05, 43, 94	11-13
P0406	Motor Ventilation	0 = Self-Vent. 1 = Separate Vent. 2 = Optimal Flux 3 = Extended Protection	0		CFG	05, 43, 94	11-14
P0407	Motor Rated Power Fac	0.50 to 0.99	0.68		CFG and VVW	05, 43, 94	11-14
P0408	Run Self-Tuning	0 = No 1 = No Rotation 2 = Run for I_m 3 = Run for T_m 4 = Estimate T_m	0		CFG, VVW and Vector	05, 43, 94	11-14
P0409	Stator Resistance	0.000 to 9.999 ohm	0.000 ohm		CFG, VVW, PM and Vector	05, 43, 94	11-14

Parameter	Function	Adjustable Range	Factory Setting	User Setting	Properties	Groups	Pag.
P0410	Magnetization Current	0 to 1.25x _{nom-ND}	I _{nom-ND}		V/f, VVW and Vector	05, 43, 94	11-14
P0411	Leakage Inductance	0.00 to 99.99 mH	0.00 mH		CFG and Vector	05, 43, 94	11-14
P0412	T _r Time Constant	0.000 to 9.999 s	0.000 s		Vector	05, 43, 94	11-14
P0413	T _m Time Constant	0.00 to 99.99 s	0.00 s		Vector	05, 43, 94	11-14
P0414	Motor Magnetization Time	0.000 to 9.999 s	0.000 s		Vector	43	11-15
P0430	Type PM	0 = Factory Setting 1 = Cooling Tower	0		CFG and PM	05, 43, 94	21-7
P0431	Pole Number	2 to 24	6		CFG PM	05, 43, 94	21-7
P0433	Lq Inductance	0.00 to 100.00 mH	0.00 mH		CFG PM	05, 43, 94	21-8
P0434	Ld Inductance	0.00 to 100.00 mH	0.00 mH		CFG PM	05, 43, 94	21-8
P0435	Ke Constant	0.0 to 600.0	100.0		CFG PM	05, 43, 94	21-8
P0438	Iq Prop. Gain	0.00 to 1.99	0.80		PM	91	21-10
P0439	Iq Integral Gain	0.000 to 1.999	0.005		PM	91	21-10
P0440	Id Prop. Gain	0.00 to 1.99	0.50		PM	91	21-10
P0441	Id Integral Gain	0.000 to 1.999	0.005		PM	91	21-10
P0442	Inductance Lq – CT	0.0 to 400.0 mH	0.0 mH		CFG and PM_CT	05, 43, 94	21-8
P0443	Inductance Ld – CT	0.0 to 400.0 mH	0.0 mH		CFG and PM_CT	05, 43, 94	21-8
P0444	Constant Ke – CT	0 to 3000	100		CFG and PM_CT	05, 43, 94	21-9
P0520	PID Proportional Gain	0.000 to 7.999	1.000		-	46	20-10
P0521	PID Integral Gain	0.000 to 7.999	0.043		-	46	20-10
P0522	PID Differential Gain	0.000 to 3.499	0.000		-	46	20-10
P0523	PID Ramp Time	0.0 to 999.0 s	3.0 s		-	46	20-11
P0524	PID Feedback Sel.	0 = AI1 (P0231) 1 = AI2 (P0236) 2 = AI3 (P0241) 3 = AI4 (P0246)	1		CFG	38, 46	20-11
P0525	Keypad PID Setpoint	0.0 to 100.0 %	0.0 %		-	46	20-12
P0527	PID Action Type	0 = Direct 1 = Reverse	0		-	46	20-12
P0528	Proc. V. Scale Factor	1 to 9999	1000		-	46	20-12
P0529	Proc.V. Decimal Point	0 = wxyz 1 = wxy.z 2 = wx.yz 3 = w.xyz	1		-	46	20-13
P0530	Proc. V. Eng. Unit 1	32 to 127	37		-	46	20-14
P0531	Proc. V. Eng. Unit 2	32 to 127	32		-	46	20-14
P0532	Proc. V. Eng. Unit 3	32 to 127	32		-	46	20-14
P0533	PVx Value	0.0 to 100.0 %	90.0 %		-	46	20-14
P0534	PVy Value	0.0 to 100.0 %	10.0 %		-	46	20-14
P0535	Wake Up Band	0 to 100 %	0 %		-	35, 46	20-15
P0536	P0525 Autom. Setting	0 = Off 1 = On	1		CFG	46	20-15
P0538	Hysteresis VPx/VPy	0.0 to 5.0 %	1.0 %		-	46	20-15
P0550	Trigger Signal Source	0 = Not selected 1 = Speed Refer. 2 = Motor Speed 3 = Motor Current 4 = DC Link Volt. 5 = Motor Freq. 6 = Motor Voltage 7 = Motor Torque 8 = Process Var. 9 = Setpoint PID 10 = AI1 11 = AI2 12 = AI3 13 = AI4	0		-	52	19-1
P0551	Trigger Level	-100.0 to 340.0 %	0.0 %		-	52	19-1

Quick Parameter Reference, Faults and Alarms

0

Parameter	Function	Adjustable Range	Factory Setting	User Setting	Properties	Groups	Pag.
P0552	Trigger Condition	0 = P0550* = P0551 1 = P0550* <> P0551 2 = P0550* > P0551 3 = P0550* < P0551 4 = Alarm 5 = Fault 6 = Dlx	5		-	52	19-2
P0553	Trace Sampling Period	1 to 65535	1		-	52	19-3
P0554	Trace Pre-Trigger	0 to 100 %	0 %		-	52	19-3
P0559	Trace Max. Memory	0 to 100 %	0 %		-	52	19-3
P0560	Trace Avail. Memory	0 to 100 %	-		RO	52	19-4
P0561	Trace Channel 1 (CH1)	0 = Not selected 1 = Speed Refer. 2 = Motor Speed 3 = Motor Current 4 = DC Link Volt. 5 = Motor Freq. 6 = Motor Voltage 7 = Motor Torque 8 = Process Var. 9 = Setpoint PID 10 = AI1 11 = AI2 12 = AI3 13 = AI4	1		-	52	19-4
P0562	Trace Channel 2 (CH2)	See options in P0561	2		-	52	19-4
P0563	Trace Channel 3 (CH3)	See options in P0561	3		-	52	19-4
P0564	Trace Channel 4 (CH4)	See options in P0561	0		-	52	19-4
P0571	Start Trace Function	0 = Off 1 = On	0		-	52	19-5
P0572	Trace Trig. Day/Month	00/00 to 31/12	-		RO	09, 52	19-5
P0573	Trace Trig. Year	00 to 99	-		RO	09, 52	19-5
P0574	Trace Trig. Time	00:00 to 23:59	-		RO	09, 52	19-5
P0575	Trace Trig. Seconds	00 to 59	-		RO	09, 52	19-5
P0576	Trace Function Status	0 = Off 1 = Waiting 2 = Trigger 3 = Concluded	-		RO	09, 52	19-6
P0586	Energy Saving Config.	0 = Off 1 = On	0		V/f and Vector		9-14
P0587	Cos Phi Reference	0.5 to 1.00	0.9 * P0407		V/f and Vector		9-14
P0588	Energy Sav. Max. Torq	0 to 100 %	60 %		V/f and Vector		9-15
P0589	Energy Sav. Min. Volt/Flux	40 to 80 %	40 %		V/f and Vector		9-15
P0590	Energy Sav. Min. Sp.	0 to 18000 rpm	600 (525) rpm		V/f and Vector		9-16
P0591	Energy Sav. Hysteresis	0 to 30 %	10 %		V/f and Vector		9-16
P0600	Firmware Update	0 = Off 1 = VFD -> MemCard 2 = MemCard -> VFD	0		CFG		9-16
P0613	Firmware Revision	-32768 to 32767	0		RO	09	16-10
P0614	Revision of the PLD	-32768 to 32767	0		RO	09	16-10
P0680	Logical Status	Bit 0 to 3 = Not Used Bit 4 = Quick Stop ON Bit 5 = 2nd Ramp Bit 6 = Config. Mode Bit 7 = Alarm Bit 8 = Running Bit 9 = Enabled Bit 10 = Forward Bit 11 = JOG Bit 12 = Remote Bit 13 = Subvoltage Bit 14 = Automatic(PID) Bit 15 = Fault	-		RO	09, 111	17-5
P0681	Speed in 13 bits	-32768 to 32767	-		RO	09, 111	17-5

Parameter	Function	Adjustable Range	Factory Setting	User Setting	Properties	Groups	Pag.
P0682	Serial/USB Control	Bit 0 = Ramp Enable Bit 1 = General Enable Bit 2 = Run Forward Bit 3 = JOG Enable Bit 4 = Remote Bit 5 = 2nd Ramp Bit 6 = Reserved Bit 7 = Fault Reset Bit 8 to 15 = Reserved	-		RO	09, 111	17-1
P0683	Serial/USB Speed Ref.	-32768 to 32767	-		RO	09, 111	17-1
P0684	CO/DN/DP Control	See options in P0682	-		RO	09, 111	17-1
P0685	CO/DN/DP Speed Ref	-32768 to 32767	-		RO	09, 111	17-1
P0686	Anybus-CC Control	See options in P0682	-		RO	09, 111	17-2
P0687	Anybus-CC Speed Ref.	-32768 to 32767	-		RO	09, 111	17-2
P0692	Operating Mode States	0 to 65535	0		RO	09	17-5
P0695	DOx Value	Bit 0 = DO1 Bit 1 = DO2 Bit 2 = DO3 Bit 3 = DO4 Bit 4 = DO5	-		RO	09, 111	17-5
P0696	AOx Value 1	-32768 to 32767	-		RO	09, 111	17-5
P0697	AOx Value 2	-32768 to 32767	-		RO	09, 111	17-5
P0698	AOx Value 3	-32768 to 32767	-		RO	09, 111	17-5
P0699	AOx Value 4	-32768 to 32767	-		RO	09, 111	17-5
P0700	CAN Protocol	1 = CANopen 2 = DeviceNet	2		CFG	112	17-1
P0701	CAN Address	0 to 127	63		CFG	112	17-1
P0702	CAN Baud Rate	0 = 1 Mbps/Auto 1 = Reserved 2 = 500 Kbps/Auto 3 = 250 Kbps 4 = 125 Kbps 5 = 100 Kbps/Auto 6 = 50 Kbps/Auto 7 = 20 Kbps/Auto 8 = 10 Kbps/Auto	0		CFG	112	17-1
P0703	Bus Off Reset	0 = Manual 1 = Automatic	1		CFG	112	17-1
P0705	CAN Controller Status	0 = Disabled 1 = Auto-baud 2 = CAN Enabled 3 = Warning 4 = Error Passive 5 = Bus Off 6 = No Bus Power	-		RO	09, 112	17-1
P0706	RX CAN Telegrams	0 to 65535	-		RO	09, 112	17-1
P0707	TX CAN Telegrams	0 to 65535	-		RO	09, 112	17-1
P0708	Bus Off Counter	0 to 65535	-		RO	09, 112	17-1
P0709	CAN Lost Messages	0 to 65535	-		RO	09, 112	17-1
P0710	DNet I/O instances	0 = ODVA Basic 2W 1 = ODVA Extend 2W 2 = Manuf.Spec. 2W 3 = Manuf.Spec. 3W 4 = Manuf.Spec. 4W 5 = Manuf.Spec. 5W 6 = Manuf.Spec. 6W	0		-	112	17-1
P0711	DNet Read Word #3	-1 to 1499	-1		-	112	17-2
P0712	DNet Read Word #4	-1 to 1499	-1		-	112	17-2
P0713	DNet Read Word #5	-1 to 1499	-1		-	112	17-2
P0714	DNet Read Word #6	-1 to 1499	-1		-	112	17-2
P0715	DNet Write Word #3	-1 to 1499	-1		-	112	17-2
P0716	DNet Write Word #4	-1 to 1499	-1		-	112	17-2
P0717	DNet Write Word #5	-1 to 1499	-1		-	112	17-2
P0718	DNet Write Word #6	-1 to 1499	-1		-	112	17-2

Quick Parameter Reference, Faults and Alarms

0

Parameter	Function	Adjustable Range	Factory Setting	User Setting	Properties	Groups	Pag.
P0719	DNet Network Status	0 = Offline 1 = OnLine,NotConn 2 = OnLine,Conn 3 = Conn.Timed-out 4 = Link Failure 5 = Auto-Baud	-		RO	09, 112	17-2
P0720	DNet Master Status	0 = Run 1 = Idle	-		RO	09, 112	17-2
P0721	CANopen Comm. Status	0 = Disabled 1 = Reserved 2 = Comm. Enabled 3 = Error Ctrl.Enab 4 = Guarding Error 5 = Heartbeat Error	-		RO	09, 112	17-2
P0722	CANopen Node State	0 = Disabled 1 = Initialization 2 = Stopped 3 = Operational 4 = PreOperational	-		RO	09, 112	17-2
P0723	Anybus Identification	0 = Disabled 1 = RS232 2 = RS422 3 = USB 4 = Serial Server 5 = Bluetooth 6 = Zigbee 7 = Reserved 8 = Reserved 9 = Reserved 10 = RS485 11 = Reserved 12 = Reserved 13 = Reserved 14 = Reserved 15 = Reserved 16 = Profibus DP 17 = DeviceNet 18 = CANopen 19 = EtherNet/IP 20 = DC-Link 21 = Modbus-TCP 22 = Modbus-RTU 23 = Profinet IO 24 = Reserved 25 = Reserved	-		RO	09, 114	17-2
P0724	Anybus Comm. Status	0 = Disabled 1 = Not Supported 2 = Access Error 3 = Offline 4 = Online	-		RO	09, 114	17-2
P0725	Anybus Address	0 to 255	0		CFG	114	17-2
P0726	Anybus Baud Rate	0 to 3	0		CFG	114	17-2
P0727	Anybus I/O Words	2 = 2 Words 3 = 3 Words 4 = 4 Words 5 = 5 Words 6 = 6 Words 7 = 7 Words 8 = 8 Words 9 = PLC11 Board	2		CFG	114	17-2
P0728	Anybus Read Word #3	0 to 1499	0		CFG	114	17-2
P0729	Anybus Read Word #4	0 to 1499	0		CFG	114	17-2
P0730	Anybus Read Word #5	0 to 1499	0		CFG	114	17-2
P0731	Anybus Read Word #6	0 to 1499	0		CFG	114	17-2
P0732	Anybus Read Word #7	0 to 1499	0		CFG	114	17-2
P0733	Anybus Read Word #8	0 to 1499	0		CFG	114	17-3
P0734	Anybus Write Word #3	0 to 1499	0		CFG	114	17-3
P0735	Anybus Write Word #4	0 to 1499	0		CFG	114	17-3
P0736	Anybus Write Word #5	0 to 1499	0		CFG	114	17-3
P0737	Anybus Write Word #6	0 to 1499	0		CFG	114	17-3
P0738	Anybus Write Word #7	0 to 1499	0		CFG	114	17-3
P0739	Anybus Write Word #8	0 to 1499	0		CFG	114	17-3

Parameter	Function	Adjustable Range	Factory Setting	User Setting	Properties	Groups	Pag.
P0740	Profibus Comm. Status	0 = Disabled 1 = Access Error 2 = Offline 3 = Config.Error 4 = Param.Error 5 = Clear Mode 6 = Online	-		RO	09, 115	-
P0741	Profibus Data Profile	0 = PROFIdrive 1 = Manufacturer	1		CFG	115	17-4
P0742	Profibus Reading Word #3	0 to 1199	0		-	115	17-4
P0743	Profibus Reading Word #4	0 to 1199	0		-	115	17-4
P0744	Profibus Reading Word #5	0 to 1199	0		-	115	17-4
P0745	Profibus Reading Word #6	0 to 1199	0		-	115	17-4
P0746	Profibus Reading Word #7	0 to 1199	0		-	115	17-4
P0747	Profibus Reading Word #8	0 to 1199	0		-	115	17-4
P0748	Profibus Reading Word #9	0 to 1199	0		-	115	17-4
P0749	Profibus Reading Word#10	0 to 1199	0		-	115	17-4
P0750	Profibus Writing Word#3	0 to 1199	0		-	115	17-4
P0751	Profibus Writing Word#4	0 to 1199	0		-	115	17-4
P0752	Profibus Writing Word#5	0 to 1199	0		-	115	17-4
P0753	Profibus Writing Word#6	0 to 1199	0		-	115	17-4
P0754	Profibus Writing Word#7	0 to 1199	0		-	115	17-4
P0755	Profibus Writing Word#8	0 to 1199	0		-	115	17-4
P0756	Profibus Writing Word#9	0 to 1199	0		-	115	17-4
P0757	Profibus Writing Word#10	0 to 1199	0		-	115	17-4
P0760	PROFIdrive Output I	0 to 16384	-	-	-	115	17-4
P0761	PROFIdrive Active P	0 to 16384	-	-	-	115	17-5
P0762	PROFIdrive Torque Val	-16535 to 16384	-	-	-	115	17-5
P0763	PROFIdrive SW NAMUR	0 to 65535	-	-	-	115	17-5
P0799	Delay Update I/O	0.0 to 999.0	0.0		-	111	17-6
P0800	Phase U Book 1 Temperature	-20.0 to 150.0 °C	-		CFW-11M RO	09, 45	15-17
P0801	Phase V Book 1 Temperature	-20.0 to 150.0 °C	-		CFW-11M RO	09, 45	15-17
P0802	Phase W Book 1 Temperature	-20.0 to 150.0 °C	-		CFW-11M RO	09, 45	15-17
P0803	Phase U Book 2 Temperature	-20.0 to 150.0 °C	-		CFW-11M RO	09, 45	15-17
P0804	Phase V Book 2 Temperature	-20.0 to 150.0 °C	-		CFW-11M RO	09, 45	15-17
P0805	Phase W Book 2 Temperature	-20.0 to 150.0 °C	-		CFW-11M RO	09, 45	15-17
P0806	Phase U Book 3 Temperature	-20.0 to 150.0 °C	-		CFW-11M RO	09, 45	15-17
P0807	Phase V Book 3 Temperature	-20.0 to 150.0 °C	-		CFW-11M RO	09, 45	15-17
P0808	Phase W Book 3 Temperature	-20.0 to 150.0 °C	-		CFW-11M RO	09, 45	15-17
P0809	Phase U Book 4 Temperature	-20.0 to 150.0 °C	-		CFW-11M RO	09, 45	15-17
P0810	Phase V Book 4 Temperature	-20.0 to 150.0 °C	-		CFW-11M RO	09, 45	15-17
P0811	Phase W Book 4 Temperature	-20.0 to 150.0 °C	-		CFW-11M RO	09, 45	15-17
P0812	Phase U Book 5 Temperature	-20.0 to 150.0 °C	-		CFW-11M RO	09, 45	15-17
P0813	Phase V Book 5 Temperature	-20.0 to 150.0 °C	-		CFW-11M RO	09, 45	15-17
P0814	Phase W Book 5 Temperature	-20.0 to 150.0 °C	-		CFW-11M RO	09, 45	15-18
P0832	DIM1 Function	0 = Not Used 1 = No Ext.Fault IPS 2 = No Refrig. Fault 3 = No Br Overt Fault 4 = No Rect.Overt F 5 = No Rect.Temp Al 6 = No Rect. Fault	0		CFW-11M	45, 40	15-18

Quick Parameter Reference, Faults and Alarms

0

Parameter	Function	Adjustable Range	Factory Setting	User Setting	Properties	Groups	Pag.
P0833	DIM2 Function	See options in P0832	0		CFW-11M	45, 40	15-18
P0834	DIM1 DIM2 Status	Bit 0 = DIM1 Bit 1 = DIM2	-		CFW-11M and RO	09, 40	15-18
P0840	Anybus Status	0 = Setup 1 = Init 2 = Wait Comm 3 = Idle 4 = Data Active 5 = Error 6 = Reserved 7 = Exception 8 = Access Error	-	RO	-	-	17-3
P0841	Eth:Baud rate	0 = Auto 1 = 10 Mbps, half 2 = 10 Mbps, full 3 = 100 Mbps, half 4 = 100 Mbps, full	0 = Auto	-	-	-	17-3
P0842	Eth:ModbusTCP timeout	0 to 655	0	-	-	-	17-3
P0843	Eth:IP Address Config	0 = Parameters 1 = DHCP 2 = DCP 3 = IP Config	1 = DHCP	-	-	-	17-3
P0844	Eth:IP Address 1	0 to 255	192	-	-	-	17-3
P0845	Eth:IP Address 2	0 to 255	168	-	-	-	17-3
P0846	Eth:IP Address 3	0 to 255	0	-	-	-	17-3
P0847	Eth:IP Address 4	0 to 255	10				17-3
P0848	CIDR	0 to 255	24				17-3
P0849	Gateway 1	0 to 255	0				17-3
P0850	Gateway 2	0 to 255	0				17-3
P0851	Gateway 3	0 to 255	0				17-3
P0852	Gateway 4	0 to 255	0				17-3
P0853	Station Name	0 to 255	0				17-3
P0854	Compatible mode	0 = Modbus WEG 1 = Modbus Anybus	0 = Modbus WEG				17-4
P0918	Profibus Address	1 to 126	1			115	17-5
P0922	Profibus Teleg. Sel.	1 = Std. Teleg. 1 2 = Telegram 100 3 = Telegram 101 4 = Telegram 102 5 = Telegram 103 6 = Telegram 104 7 = Telegram 105 8 = Telegram 106 9 = Telegram 107	1		CFG	115	17-5
P0944	Fault Message Counter	0 to 65535			RO	09, 115	17-5
P0947	Fault Number	0 to 65535			RO	09, 115	17-5
P0963	Profibus Baud Rate	0 = 9.6 kbit/s 1 = 19.2 kbit/s 2 = 93.75 kbit/s 3 = 187.5 kbit/s 4 = 500 kbit/s 5 = Not Detected 6 = 1500 kbit/s 7 = 3000 kbit/s 8 = 6000 kbit/s 9 = 12000 kbit/s 10 = Reserved 11 = 45.45 kbit/s			RO	09, 115	17-5
P0964	Drive Unit Ident.	0 to 65535			RO	09, 115	17-5
P0965	Profile Ident. Number	0 to 65535			RO	09, 115	17-5

Parameter	Function	Adjustable Range	Factory Setting	User Setting	Properties	Groups	Pag.
P0967	Control Word PROFdrive	Bit 0 = ON Bit 1 = No Coast Stop Bit 2 = No Quick Stop Bit 3 = Enable Operation Bit 4 = Enable Ramp Generator Bit 5 = Reserved Bit 6 = Enable Setpoint Bit 7 = Fault Acknowledge Bit 8 = Jog 1 Bit 9 = Reserved Bit 10 = Control by PLC Bit 11 ... 15 = Reserved			RO	09, 115	17-5
P0968	Status Word PROFdrive	Bit 0 = Ready To Switch On Bit 1 = Ready To Operate Bit 2 = Operation Enabled Bit 3 = Fault Present Bit 4 = Coast Stop Not Active Bit 5 = Quick Stop Not Active Bit 6 = Switching On Inhibited Bit 7 = Warning Present Bit 8 = Reserved Bit 9 = Control By PLC Bit 10 ... 15 = Reserved			RO	09, 115	17-5
P1000	SoffPLC Status	0 = No Application 1 = Install. App. 2 = Incompat. App. 3 = App. Stopped 4 = App. Running	-		RO	09, 50	18-1
P1001	SoffPLC Command	0 = Stop Program 1 = Run Program 2 = Delete Program	0		CFG	50	18-1
P1002	Scan Cycle Time	0 to 65535 ms	-		RO	09, 50	18-1
P1004	SoffPLC Supervision	0 = Inactive 1 = Alarm A708 2 = Fault F709	0		-	50	18-1
P1010	SoffPLC Parameter 1	-32768 to 32767	0		-	50	18-1
P1011	SoffPLC Parameter 2	-32768 to 32767	0		-	50	18-1
P1012	SoffPLC Parameter 3	-32768 to 32767	0		-	50	18-1
P1013	SoffPLC Parameter 4	-32768 to 32767	0		-	50	18-1
P1014	SoffPLC Parameter 5	-32768 to 32767	0		-	50	18-1
P1015	SoffPLC Parameter 6	-32768 to 32767	0		-	50	18-1
P1016	SoffPLC Parameter 7	-32768 to 32767	0		-	50	18-1
P1017	SoffPLC Parameter 8	-32768 to 32767	0		-	50	18-1
P1018	SoffPLC Parameter 9	-32768 to 32767	0		-	50	18-1
P1019	SoffPLC Parameter 10	-32768 to 32767	0		-	50	18-1
P1020	SoffPLC Parameter 11	-32768 to 32767	0		-	50	18-1
P1021	SoffPLC Parameter 12	-32768 to 32767	0		-	50	18-1
P1022	SoffPLC Parameter 13	-32768 to 32767	0		-	50	18-1
P1023	SoffPLC Parameter 14	-32768 to 32767	0		-	50	18-1
P1024	SoffPLC Parameter 15	-32768 to 32767	0		-	50	18-1
P1025	SoffPLC Parameter 16	-32768 to 32767	0		-	50	18-1
P1026	SoffPLC Parameter 17	-32768 to 32767	0		-	50	18-1
P1027	SoffPLC Parameter 18	-32768 to 32767	0		-	50	18-1
P1028	SoffPLC Parameter 19	-32768 to 32767	0		-	50	18-1
P1029	SoffPLC Parameter 20	-32768 to 32767	0		-	50	18-1
P1030	SoffPLC Parameter 21	-32768 to 32767	0		-	50	18-1
P1031	SoffPLC Parameter 22	-32768 to 32767	0		-	50	18-1
P1032	SoffPLC Parameter 23	-32768 to 32767	0		-	50	18-1
P1033	SoffPLC Parameter 24	-32768 to 32767	0		-	50	18-1
P1034	SoffPLC Parameter 25	-32768 to 32767	0		-	50	18-1
P1035	SoffPLC Parameter 26	-32768 to 32767	0		-	50	18-1
P1036	SoffPLC Parameter 27	-32768 to 32767	0		-	50	18-1
P1037	SoffPLC Parameter 28	-32768 to 32767	0		-	50	18-1
P1038	SoffPLC Parameter 29	-32768 to 32767	0		-	50	18-1

Quick Parameter Reference, Faults and Alarms

0

Parameter	Function	Adjustable Range	Factory Setting	User Setting	Properties	Groups	Pag.
P1039	SoftPLC Parameter 30	-32768 to 32767	0		-	50	18-1
P1040	SoftPLC Parameter 31	-32768 to 32767	0		-	50	18-1
P1041	SoftPLC Parameter 32	-32768 to 32767	0		-	50	18-1
P1042	SoftPLC Parameter 33	-32768 to 32767	0		-	50	18-1
P1043	SoftPLC Parameter 34	-32768 to 32767	0		-	50	18-1
P1044	SoftPLC Parameter 35	-32768 to 32767	0		-	50	18-1
P1045	SoftPLC Parameter 36	-32768 to 32767	0		-	50	18-1
P1046	SoftPLC Parameter 37	-32768 to 32767	0		-	50	18-1
P1047	SoftPLC Parameter 38	-32768 to 32767	0		-	50	18-1
P1048	SoftPLC Parameter 39	-32768 to 32767	0		-	50	18-1
P1049	SoftPLC Parameter 40	-32768 to 32767	0		-	50	18-1
P1050	SoftPLC Parameter 41	-32768 to 32767	0		-	50	18-1
P1051	SoftPLC Parameter 42	-32768 to 32767	0		-	50	18-1
P1052	SoftPLC Parameter 43	-32768 to 32767	0		-	50	18-1
P1053	SoftPLC Parameter 44	-32768 to 32767	0		-	50	18-1
P1054	SoftPLC Parameter 45	-32768 to 32767	0		-	50	18-1
P1055	SoftPLC Parameter 46	-32768 to 32767	0		-	50	18-1
P1056	SoftPLC Parameter 47	-32768 to 32767	0		-	50	18-1
P1057	SoftPLC Parameter 48	-32768 to 32767	0		-	50	18-1
P1058	SoftPLC Parameter 49	-32768 to 32767	0		-	50	18-1
P1059	SoftPLC Parameter 50	-32768 to 32767	0		-	50	18-1

Notes:

RO = Read only parameter.

rw = Read/write parameter.

CFG = Configuration parameter, value can be programmed only with motor stopped.

V/f = Available when V/f control mode is chosen.

Adj = Available when adjustable V/f control mode is chosen.

VVW = Available when VVW control mode is chosen.

Vector = Available when a vector control mode is chosen.

Sless = Available when sensorless control mode is chosen.

PM = Available when permanent magnet motor control is chosen.

Encoder = Available when vector control with encoder is chosen.

CFW-11M = Available for Modular Drive models.

PM = Parameter available to control permanent magnet motors.

PM_CT = Parameter available to control permanent magnet motors only - Cooling Tower.

Wmagnet = Parameter available to control permanent magnet motors only – Wmagnet.

Fault/Alarm	Description	Possible Causes
F006 ⁽¹⁾ Imbalance or Input Phase Loss	Mains voltage imbalance too high or phase missing in the input power supply. Note: - If the motor is unloaded or operating with reduced load this fault may not occur. - Fault delay is set at parameter P0357. P0357 = 0 disables the fault. - If single-phase power supply is used, this fault must be disabled.	<input checked="" type="checkbox"/> Phase missing at the inverter's input power supply. <input checked="" type="checkbox"/> Input voltage imbalance >5 %. For the Frame Size E: <input checked="" type="checkbox"/> Phase loss at L3/R or L3/S may cause F021 or F185. <input checked="" type="checkbox"/> Phase loss at L3/T will cause F006. For frame sizes F and G: <input checked="" type="checkbox"/> Pre-charge circuit fault.
A010 ⁽²⁾ Rectifier High Temperature	A high temperature alarm was detected by the NTC temperature sensors located in the rectifier modules. - It may be disabled by setting P0353 = 2 or 3.	<input checked="" type="checkbox"/> Surrounding air temperature is too high (>50 °C (122 °F)) and output current is too high. <input checked="" type="checkbox"/> Blocked or defective fan. <input checked="" type="checkbox"/> Inverter heatsink is completely covered with dust.
F011 ⁽²⁾ Rectifier Overtemperature	An overtemperature fault was detected by the NTC temperature sensors located in the rectifier modules.	<input checked="" type="checkbox"/> Surrounding air temperature is too high (>50 °C (122 °F)) and output current is too high. <input checked="" type="checkbox"/> Blocked or defective fan. <input checked="" type="checkbox"/> Inverter heatsink is completely covered with dust.
F020 ⁽¹⁰⁾ Undervoltage in the 24 Vdc Power Supply	Undervoltage fault in the 24 Vdc power supply.	<input checked="" type="checkbox"/> Voltage of the 24 Vdc control power supply below the minimum value of 22.8 Vdc.
F021 DC Link Undervoltage	DC link undervoltage condition occurred.	<input checked="" type="checkbox"/> The input voltage is too low and the DC bus voltage dropped below the minimum permitted value (monitor the value at parameter P0004): Ud < 223 V - For a 200-240 V three-phase input voltage. Ud < 170 V - For a 200-240 V single-phase input voltage (models CFW11XXXXS2 or CFW11XXXXB2) (P0296 = 0). Ud < 385 V - For a 380 V input voltage (P0296 = 1). Ud < 405 V - For a 400-415 V input voltage (P0296 = 2). Ud < 446 V - For a 440-460 V input voltage (P0296 = 3). Ud < 487 V - For a 480 V input voltage (P0296 = 4). Ud < 530 V - Supply voltage 500-525 V (P0296 = 5). Ud < 580 V - Supply voltage 550-575 V (P0296 = 6). Ud < 605 V - Supply voltage 600 V (P0296 = 7). Ud < 696 V - Supply voltage 660-690 V (P0296 = 8). <input checked="" type="checkbox"/> Phase loss in the input power supply. <input checked="" type="checkbox"/> Pre-charge circuit failure. <input checked="" type="checkbox"/> Parameter P0296 was set to a value above of the power supply rated voltage.
F022 DC Link Overvoltage	DC link overvoltage condition occurred.	<input checked="" type="checkbox"/> The input voltage is too high and the DC bus voltage surpassed the maximum permitted value: Ud > 400 V - For 220-230 V input models (P0296 = 0). Ud > 800 V - For 380-480 V input models (P0296 = 1, 2, 3, or 4). Ud > 1000 V - For 500-600 V input models (P0296 = 5, 6 and 7). Ud > 1200 V - For 660-690 V (P0296 = 8). <input checked="" type="checkbox"/> Inertia of the driven-load is too high or deceleration time is too short. <input checked="" type="checkbox"/> Wrong settings for parameters P0151, or P0153, or P0185.
F028 Motor Stop Time Exceeded	Motor stop time exceeded fault.	<input checked="" type="checkbox"/> Motor being dragged by the load. <input checked="" type="checkbox"/> Sensorless control with wrong orientation.
F030 ⁽¹³⁾ Power Module U Fault	Desaturation of IGBT occurred in Power Module U.	<input checked="" type="checkbox"/> Short-circuit between motor phases U and V or U and W.
F034 ⁽¹³⁾ Power Module V Fault	Desaturation of IGBT occurred in Power Module V.	<input checked="" type="checkbox"/> Short-circuit between motor phases V and U or V and W.
F038 ⁽¹³⁾ Power Module W Fault	Desaturation of IGBT occurred in Power Module W.	<input checked="" type="checkbox"/> Short-circuit between motor phases W and U or W and V.
F042 ⁽⁹⁾ DB IGBT Fault	Desaturation of Dynamic Braking IGBT occurred.	<input checked="" type="checkbox"/> Short-circuit between the connection cables of the dynamic braking resistor.
A046 High Load on Motor	Load is too high for the used motor. Note: It may be disabled by setting P0348 = 0 or 2.	<input checked="" type="checkbox"/> Settings of P0156, P0157, and P0158 are too low for the used motor. <input checked="" type="checkbox"/> Motor shaft load is excessive.
A047 ⁽¹⁾ IGBT Overload Alarm	An IGBTs overload alarm occurred. Note: It may be disabled by setting P0350 = 0 or 2.	<input checked="" type="checkbox"/> Inverter output current is too high.
F048 ⁽¹⁾ IGBT Overload Fault	An IGBTs overload fault occurred.	<input checked="" type="checkbox"/> Inverter output current is too high.

Fault/Alarm	Description	Possible Causes
A050 ⁽¹⁾ IGBT High Temperature U	A high temperature alarm was detected by the NTC temperature sensors located on the IGBTs. Note: It may be disabled by setting P0353 = 2 or 3.	<input checked="" type="checkbox"/> Surrounding air temperature is too high and output current is too high for further information on the maximum ambient temperature, refer to the user manual. <input checked="" type="checkbox"/> Blocked or defective fan. <input checked="" type="checkbox"/> Very dirty heatsink.
F051 ⁽¹⁾ IGBT Overtemperature U	A high temperature fault was detected by the NTC temperature sensors located on the IGBTs.	
A053 ⁽¹²⁾ High Temperature on IGBTs V	Alarm of high temperature measured at the temperature sensors (NTC) of the IGBTs. Note: It can be disabled by setting P0353 = 2 or 3.	
F054 ⁽¹²⁾ Overtemperature on IGBTs V	Fault of overtemperature measured at the temperature sensors (NTC) of the IGBTs.	
A056 ⁽¹²⁾ High Temperature on IGBTs W	Alarm of high temperature measured at the temperature sensors (NTC) of the IGBTs. Note: It can be disabled by setting P0353 = 2 or 3.	
F057 ⁽¹²⁾ Overtemperature on IGBTs W	Fault of overtemperature measured at the temperature sensors (NTC) of the IGBTs.	
F065 Encoder Signal Fault (SW)	Feedback obtained via encoder does not match the commanded speed. The fault can be disabled via parameter P0358	<input checked="" type="checkbox"/> Wiring between encoder and encoder interface accessory interrupted. <input checked="" type="checkbox"/> Encoder is defective. <input checked="" type="checkbox"/> Encoder coupling to the motor is broken. <input checked="" type="checkbox"/> Inverter operating in current limit (In case the application needs to run in such condition, this fault should be disabled via parameter P0358).
F066 Encoder Signal Fault (SW)	Feedback obtained via encoder does not match the commanded speed. The fault can be disabled via parameter P0358	<input checked="" type="checkbox"/> Wiring between encoder and encoder interface accessory interrupted. <input checked="" type="checkbox"/> Encoder is defective. <input checked="" type="checkbox"/> Encoder coupling to the motor is broken. <input checked="" type="checkbox"/> Inverter operating in current limit (In case the application needs to run in such condition, this fault should be disabled via parameter P0358).
F067 Incorrect Encoder/ Motor Wiring	Fault related to the phase relation of the encoder signals, if P0202 = 4 and P0408 = 0, 2, 3 or 4. Note: - It is not possible to reset this fault (when P0408 > 1). - In this case, turn off the power supply, solve the problem, and then turn it on again. - When P0408 = 0, it is possible to reset this fault. This fault could be disabled by means of parameter P0358. In this case it is possible to reset this fault.	<input checked="" type="checkbox"/> Output motor cables U, V, W are inverted. <input checked="" type="checkbox"/> Encoder channels A and B are inverted. <input checked="" type="checkbox"/> Encoder was not properly mounted. <input checked="" type="checkbox"/> Motor with locked rotor or dragging at the start.
F070 ⁽⁴⁾ Overcurrent / Short-circuit	Overcurrent or short-circuit detected at the output, in the DC bus, or at the braking resistor.	<input checked="" type="checkbox"/> Short-circuit between two motor phases. <input checked="" type="checkbox"/> Short-circuit between the connection cables of the dynamic braking resistor. <input checked="" type="checkbox"/> IGBT modules are shorted.
F071 Output Overcurrent	The inverter output current was too high for too long.	<input checked="" type="checkbox"/> Excessive load inertia or acceleration time too short. <input checked="" type="checkbox"/> Settings of P0135 or P0169 and P0170 are too high.
F072 Motor Overload	The motor overload protection operated. Note: It may be disabled by setting P0348 = 0 or 3.	<input checked="" type="checkbox"/> Settings of P0156, P0157 and P0158 are too low for the used motor. <input checked="" type="checkbox"/> Motor shaft load is excessive.
F074 Ground Fault	A ground fault occurred either in the cable between the inverter and the motor or in the motor itself. Note: It may be disabled by setting P0343 = 0.	<input checked="" type="checkbox"/> Shorted wiring in one or more of the output phases. <input checked="" type="checkbox"/> Motor cable capacitance is too large, resulting in current peaks at the output. ⁽¹⁴⁾
F076 Motor Current Imbalance	Fault of motor current unbalance. Note: It may be disabled by setting P0342 = 0.	<input checked="" type="checkbox"/> Loose connection or broken wiring between the motor and inverter connection. <input checked="" type="checkbox"/> Vector control with wrong orientation. <input checked="" type="checkbox"/> Vector control with encoder, encoder wiring or encoder motor connection inverted.
F077 DB Resistor Overload	The dynamic braking resistor overload protection operated.	<input checked="" type="checkbox"/> Excessive load inertia or desacceleration time too short. <input checked="" type="checkbox"/> Motor shaft load is excessive. <input checked="" type="checkbox"/> Wrong settings for parameters P0154 and P0155.

Fault/Alarm	Description	Possible Causes
F078 Motor Overtemperature	Fault related to the PTC temperature sensor installed in the motor. Note: - It may be disabled by setting P0351 = 0 or 3. - It is required to set the analog input / output to the PTC function.	<input checked="" type="checkbox"/> Excessive load at the motor shaft. <input checked="" type="checkbox"/> Excessive duty cycle (too many starts / stops per minute). <input checked="" type="checkbox"/> High ambient temperature around the motor. <input checked="" type="checkbox"/> Loose connection or short-circuit (resistance < 100 Ω) in the wiring connected to the motor termistor. <input checked="" type="checkbox"/> Motor termistor is not installed. <input checked="" type="checkbox"/> Blocked motor shaft.
F079 Encoder Signal Fault	Lack of encoder signals. The fault can be disabled via switches of the ENC1, ENC2 board.	<input checked="" type="checkbox"/> Broken wiring between encoder interface. <input checked="" type="checkbox"/> Defective encoder.x <input checked="" type="checkbox"/> Encoder accessory defective or not well installed on the product, and control configured for vector with encoder.
F080 CPU Watchdog	Microcontroller watchdog fault.	<input checked="" type="checkbox"/> Electrical noise.
F082 Copy Function Fault	Fault while copying parameters.	<input checked="" type="checkbox"/> Communication problem with the HMI.
F084 Auto-diagnosis Fault	Auto-diagnosis fault.	<input checked="" type="checkbox"/> Please contact the WEG.
A088 Communication Lost	Indicates a problem between the keypad and control board communication.	<input checked="" type="checkbox"/> Loose keypad cable connection. <input checked="" type="checkbox"/> Electrical noise in the installation.
A090 External Alarm	External alarm via digital input. Note: It is required to set a digital input to "No external alarm".	<input checked="" type="checkbox"/> Wiring was not connected to the digital input (DI1 to DI8) set to "No external alarm".
F091 External Fault	External fault via digital input. Note: It is required to set a digital input to "No external fault".	<input checked="" type="checkbox"/> Wiring was not connected to the digital input (DI1 to DI8) set to "No external fault".
F099 Invalid Current Offset	Current measurement circuit is measuring a wrong value for null current.	<input checked="" type="checkbox"/> Defect in the inverter internal circuitry.
A110 High Motor Temperature	Alarm related to the PTC temperature sensor installed in the motor. Note: - It may be disabled by setting P0351 = 0 or 2. - It is required to set the analog input / output to the PTC function.	<input checked="" type="checkbox"/> Excessive load at the motor shaft. <input checked="" type="checkbox"/> Excessive duty cycle (too many starts / stops per minute). <input checked="" type="checkbox"/> Surrounding air temperature too high. <input checked="" type="checkbox"/> Loose connection or short-circuit (resistance < 100 Ω) in the wiring connected to the motor termistor. <input checked="" type="checkbox"/> Motor termistor is not installed. <input checked="" type="checkbox"/> Blocked motor shaft.
A128 Timeout for Serial Communication	Indicates that the inverter stopped receiving valid messages within a certain time interval. Note: It may be disabled by setting P0314 = 0.0 s.	<input checked="" type="checkbox"/> Check the wiring and grounding installation. <input checked="" type="checkbox"/> Make sure the inverter has sent a new message within the time interval set at P0314.
A129 Anybus is Offline	Alarm that indicates interruption of the Anybus-CC communication.	<input checked="" type="checkbox"/> PLC entered into the idle state. <input checked="" type="checkbox"/> Programming error. Master and slave set with a different number of I/O words. <input checked="" type="checkbox"/> Communication with master has been lost (broken cable, unplugged connector, etc.).
A130 Anybus Access Error	Alarm that indicates an access error to the Anybus-CC communication module.	<input checked="" type="checkbox"/> Defective, unrecognized, or improperly installed Anybus-CC module. <input checked="" type="checkbox"/> Conflict with a WEG option board.
A133 CAN Not Powered	Alarm indicating that the power supply was not connected to the CAN controller.	<input checked="" type="checkbox"/> Broken or loose cable. <input checked="" type="checkbox"/> Power supply is off.
A134 Bus Off	Inverter CAN interface has entered into the bus-off state.	<input checked="" type="checkbox"/> Incorrect communication baud-rate. <input checked="" type="checkbox"/> Two nodes configured with the same address in the network. <input checked="" type="checkbox"/> Wrong cable connection (inverted signals).
A135 CANopen Communication Error	Alarm that indicates a communication error.	<input checked="" type="checkbox"/> Communication problems. <input checked="" type="checkbox"/> Wrong master configuration/settings. <input checked="" type="checkbox"/> Incorrect configuration of the communication objects.
A136 Idle Master	Network master has entered into the idle state.	<input checked="" type="checkbox"/> PLC in IDLE mode. <input checked="" type="checkbox"/> Bit of the PLC command register set to zero (0).
A137 DNet Connection Timeout	I/O connection timeout - DeviceNet communication alarm.	<input checked="" type="checkbox"/> One or more allocated I/O connections have entered into the timeout state.
A138 ⁽⁵⁾ Profibus DP Interface in Clear Mode	It indicates that the inverter received a command from the Profibus DP network master to enter the clear mode.	<input checked="" type="checkbox"/> Verify the network master status, making sure it is in execution mode (Run). <input checked="" type="checkbox"/> Refer to the Profibus DP communication manual for more information.

Quick Parameter Reference, Faults and Alarms

0

Fault/Alarm	Description	Possible Causes
A139 ⁽⁵⁾ Offline Profibus DP Interface	It indicates an interruption in the communication between the Profibus DP network master and the inverter.	<ul style="list-style-type: none"> ☑ Verify whether the network master is correctly configured and operating normally. ☑ Verify the network installation in a general manner - cable routing, grounding. ☑ Refer to the Profibus DP communication manual for more information.
A140 ⁽⁵⁾ Profibus DP Module Access Error	It indicates an error in the access to the Profibus DP communication module data.	<ul style="list-style-type: none"> ☑ Verify whether the Profibus DP module is correctly fit into the slot 3. ☑ Refer to the Profibus DP communication manual for more information.
F150 Motor Overspeed	Overspeed fault. It is activated when the real speed exceeds the value of $P0134 \times (100 \% + P0132)$ for more than 20 ms.	<ul style="list-style-type: none"> ☑ Wrong settings of P0161 and/or P0162. ☑ Problem with the hoist-type load.
F151 FLASH Memory Module Fault	FLASH Memory Module fault (MMF-03).	<ul style="list-style-type: none"> ☑ Defective FLASH memory module. ☑ Check the connection of the FLASH memory module.
A152 Internal Air High Temperature	Alarm indicating that the internal air temperature is too high. Note: It may be disabled by setting $P0353 = 1$ or 3 .	<ul style="list-style-type: none"> ☑ Surrounding air temperature too high and excessive output current for further information on the maximum ambient temperature, refer to the user manual. ☑ Defective internal fan (if installed).
F153 Internal Air Overtemperature	Internal air overtemperature fault.	<ul style="list-style-type: none"> ☑ For the CFW-11M and the frame sizes E, F and G: High temperature ($> 45\text{ °C}$) inside the cabinet.
A155 ⁽¹²⁾ ⁽¹⁰⁾ Undertemperature	Only 1 sensor indicates temperature below -30 °C .	<ul style="list-style-type: none"> ☑ Surrounding air temperature $\leq -30\text{ °C}$ (-22 °F).
F156 Undertemperature	Undertemperature fault (below -30 °C (-22 °F)) in the IGBTs or rectifier measured by the temperature sensors.	<ul style="list-style-type: none"> ☑ Surrounding air temperature $\leq -30\text{ °C}$ (-22 °F).
F160 Safety Stop Relays	Safety Stop relay fault.	<ul style="list-style-type: none"> ☑ Only +24 Vdc was applied to a STO input (STO1 or STO2). ☑ One of the relays is defective.
F161 Timeout PLC11CFW-11	☑ Refer to the PLC11-01 Module programming manual.	
A162 Incompatible PLC Firmware		
A163 Break Detect AI1	It indicates that the AI1 current (4-20 mA or 20-4 mA) reference is out of the 4 to 20 mA range.	<ul style="list-style-type: none"> ☑ Broken AI1 cable. ☑ Bad contact at the signal connection to the terminal strip.
A164 Break Detect AI2	It indicates that the AI2 current (4-20 mA or 20-4 mA) reference is out of the 4 to 20 mA range.	<ul style="list-style-type: none"> ☑ Broken AI2 cable. ☑ Bad contact at the signal connection to the terminal strip.
A165 Break Detect AI3	It indicates that the AI3 current (4-20 mA or 20-4 mA) reference is out of the 4 to 20 mA range.	<ul style="list-style-type: none"> ☑ Broken AI3 cable. ☑ Bad contact at the signal connection to the terminal strip.
A166 Break Detect AI4	It indicates that the AI4 current (4-20 mA or 20-4 mA) reference is out of the 4 to 20 mA range.	<ul style="list-style-type: none"> ☑ Broken AI4 cable. ☑ Bad contact at the signal connection to the terminal strip.
F174 ⁽⁶⁾ Left Fan Speed Fault	Heatsink left fan speed fault.	<ul style="list-style-type: none"> ☑ Dirt on the blades and in the bearings of the fan. ☑ Defective fan. ☑ Defective fan power supply connection.
F175 ⁽⁷⁾ Center Fan Speed Fault	Heatsink center fan speed fault.	
F176 ⁽⁶⁾ Right Fan Speed Fault	Heatsink right fan speed fault.	
A177 Fan Replacement	Fan replacement alarm ($P0045 > 50000$ hours). Note: This function may be disabled by setting $P0354 = 0$.	<ul style="list-style-type: none"> ☑ Maximum number of operating hours for the heatsink fan has been reached.
F178 Heatsink Fan Speed Alarm	This alarm indicates a problem with the heatsink fan.	<ul style="list-style-type: none"> ☑ Dirt on the blades and in the bearings of the fan. ☑ Defective fan. ☑ Defective fan power supply connection.
F179 Heatsink Fan Speed Fault	This fault indicates a problem with the heatsink fan. Note: This function may be disabled by setting $P0354 = 0$.	<ul style="list-style-type: none"> ☑ Dirt on the blades and in the bearings of the fan. ☑ Defective fan. ☑ Defective fan power supply connection.
A181 Invalid Clock Value	Invalid clock value alarm.	<ul style="list-style-type: none"> ☑ It is necessary to set date and time at parameters P0194 to P0199. ☑ Keypad battery is discharged, defective, or not installed.
F182 Pulse Feedback Fault	Indicates a fault on the output pulses feedback.	<ul style="list-style-type: none"> ☑ No motor connected or the motor connected to the inverter output is too small. ☑ Possible defect on the internal circuits of the inverter. Possible solutions: ☑ Reset inverter and try again. ☑ Set $P0356 = 0$ and try again.

Fault/Alarm	Description	Possible Causes
F183 IGBT Overload + Temperature	Overtemperature related to the IGBTs overload protection.	<input checked="" type="checkbox"/> Surrounding air temperature too high. <input checked="" type="checkbox"/> Operation with frequencies < 10 Hz under overload.
F185 (*) Pre-charge Contac Fault	It indicates fault at the pre-charge Contactor.	<input checked="" type="checkbox"/> Pre-charge contactor defect. <input checked="" type="checkbox"/> Open command fuse. <input checked="" type="checkbox"/> Phase loss in the input L1/R or L2/S. <input checked="" type="checkbox"/> P0355 = 1 (Incorrect setting for models frame E supplied by the DC link. For those models, the setting should be P0355 = 0.
F186 (*) Sensor 1 Temperature Fault	It indicates a temperature fault at the sensor 1.	<input checked="" type="checkbox"/> Motor high temperature.
F187 (*) Sensor 2 Temperature Fault	It indicates a temperature fault at the sensor 2.	
F188 (*) Sensor 3 Temperature Fault	It indicates a temperature fault at the sensor 3.	
F189 (*) Sensor 4 Temperature Fault	It indicates a temperature fault at the sensor 4.	
F190 (*) Sensor 5 Temperature Fault	It indicates a temperature fault at the sensor 5.	
A191 (*) Sensor 1 Temperature Alarm	It indicates a temperature alarm at the sensor 1.	<input checked="" type="checkbox"/> Motor high temperature. <input checked="" type="checkbox"/> A problem in the wiring connecting the sensor to the IOE 01 (02 or 03).
A192 (*) Sensor 2 Temperature Alarm	It indicates a temperature alarm at the sensor 2.	
A193 (*) Sensor 3 Temperature Alarm	It indicates a temperature alarm at the sensor 3.	
A194 (*) Sensor 4 Temperature Alarm	It indicates a temperature alarm at the sensor 4.	
A195 (*) Sensor 5 Temperature Alarm	It indicates a temperature alarm at the sensor 5.	
A196 (*) Sensor 1 Cable Alarm	Sensor 1 cable alarm.	<input checked="" type="checkbox"/> Shorted temperature sensor.
A197 (*) Sensor 2 Cable Alarm	Sensor 2 cable alarm.	
A198 (*) Sensor 3 Cable Alarm	Sensor 3 cable alarm.	
A199 (*) Sensor 4 Cable Alarm	Sensor 4 cable alarm.	
A200 (*) Sensor 5 Cable Alarm	Sensor 5 cable alarm.	
F228 Serial Communication Timeout	<input checked="" type="checkbox"/> Refer to the RS-232 / RS-485 Serial communication manual.	
F229 Anybus Offline	<input checked="" type="checkbox"/> Refer to the Anybus-CC communication manual.	
F230 Anybus Access Error		
F233 CAN Bus Power Failure	<input checked="" type="checkbox"/> Refer to the CANopen communication manual and/or the DeviceNet communication manual.	
F234 Bus Off		
F235 CANopen Communication Error	<input checked="" type="checkbox"/> Refer to the CANopen communication manual.	
F236 Master Idle	<input checked="" type="checkbox"/> Refer to the DeviceNet communication manual.	
F237 DeviceNet Connect Timeout		

(*) Temperature > 40 °C or 45 °C, depending on the model. Refer to the section 3.1 - Installation Environment, of the CFW-11M user's manual.

Fault/Alarm	Description	Possible Causes
F238 ⁽⁵⁾ Profibus DP Interface in Clear Mode	☑ Refer to the Profibus DP communication manual.	
F239 ⁽⁵⁾ Offline Profibus DP Interface		
F240 ⁽⁵⁾ Profibus DP Module Access Error		
A300 ⁽¹⁰⁾ High temperature at IGBT U B1	High temperature alarm measured with the temperature sensor (NTC) of the book 1 U phase IGBT.	☑ High ambient temperature ^(*) and high output current. ☑ Blocked or defective fan. ☑ Fins of the book heatsink too dirty, impairing the air flow.
F301 ⁽¹⁰⁾ Overtemperature at IGBT U B1	Overtemperature fault measured with the temperature sensor (NTC) of the book 1 U phase IGBT.	
A303 ⁽¹⁰⁾ High Temperature at IGBT V B1	High temperature alarm measured with the temperature sensor (NTC) of the book 1 V phase IGBT.	
F304 ⁽¹⁰⁾ Overtemperature at IGBT V B1	Overtemperature fault measured with the temperature sensor (NTC) of the book 1 V phase IGBT.	
A306 ⁽¹⁰⁾ High Temperature at IGBT W B1	High temperature alarm measured with the temperature sensor (NTC) of the book 1 W phase IGBT.	
F307 ⁽¹⁰⁾ Overtemperature at IGBT W B1	Overtemperature fault measured with the temperature sensor (NTC) of the book 1 W phase IGBT.	
A309 ⁽¹⁰⁾ High Temperature at IGBT U B2	High temperature alarm measured with the temperature sensor (NTC) of the book 2 U phase IGBT.	
F310 ⁽¹⁰⁾ Overtemperature at IGBT U B2	Overtemperature fault measured with the temperature sensor (NTC) of the book 2 U phase IGBT.	
A312 ⁽¹⁰⁾ High Temperature at IGBT V B2	High temperature alarm measured with the temperature sensor (NTC) of the book 2 V phase IGBT.	
F313 ⁽¹⁰⁾ Overtemperature at IGBT V B2	Overtemperature fault measured with the temperature sensor (NTC) of the book 2 V phase IGBT.	
A315 ⁽¹⁰⁾ High Temperature at IGBT W B2	High temperature alarm measured with the temperature sensor (NTC) of the book 2 W phase IGBT.	
F316 ⁽¹⁰⁾ Overtemperature at IGBT W B2	Overtemperature fault measured with the temperature sensor (NTC) of the book 2 W phase IGBT.	
A318 ⁽¹⁰⁾ High Temperature at IGBT U B3	High temperature alarm measured with the temperature sensor (NTC) of the book 3 U phase IGBT.	
F319 ⁽¹⁰⁾ Overtemperature at IGBT U B3	Overtemperature fault measured with the temperature sensor (NTC) of the book 3 U phase IGBT.	
A321 ⁽¹⁰⁾ High Temperature at IGBT V B3	High temperature alarm measured with the temperature sensor (NTC) of the book 3 V phase IGBT.	

(*) Temperature > 40 °C or 45 °C, depending on the model. Refer to the section 3.1 - Installation Environment, of the CFW-11M user's manual.

Fault/Alarm	Description	Possible Causes	
F322 ⁽¹⁰⁾ Overtemperature at IGBT V B3	Overtemperature fault measured with the temperature sensor (NTC) of the book 3 V phase IGBT.	<input checked="" type="checkbox"/> High ambient temperature (*) and high output current. <input checked="" type="checkbox"/> Blocked or defective fan. <input checked="" type="checkbox"/> Fins of the book heatsink too dirty, impairing the air flow.	
A324 ⁽¹⁰⁾ High Temperature at IGBT W B3	High temperature alarm measured with the temperature sensor (NTC) of the book 3 W phase IGBT.		
F325 ⁽¹⁰⁾ Overtemperature at IGBT W B3	Overtemperature fault measured with the temperature sensor (NTC) of the book 3 W phase IGBT.		
A327 ⁽¹⁰⁾ High Temperature at IGBT U B4	High temperature alarm measured with the temperature sensor (NTC) of the book 4 U phase IGBT.		
F328 ⁽¹⁰⁾ Overtemperature at IGBT U B4	Overtemperature fault measured with the temperature sensor (NTC) of the book 4 U phase IGBT.		
A330 ⁽¹⁰⁾ High Temperature at IGBT V B4	High temperature alarm measured with the temperature sensor (NTC) of the book 4 V phase IGBT.		
F331 ⁽¹⁰⁾ Overtemperature at IGBT V B4	Overtemperature fault measured with the temperature sensor (NTC) of the book 4 V phase IGBT.		
A333 ⁽¹⁰⁾ High Temperature at IGBT W B4	High temperature alarm measured with the temperature sensor (NTC) of the book 4 W phase IGBT.		
F334 ⁽¹⁰⁾ Overtemperature at IGBT W B4	Overtemperature fault measured with the temperature sensor (NTC) of the book 4 W phase IGBT.		
A336 ⁽¹⁰⁾ High Temperature at IGBT U B5	High temperature alarm measured with the temperature sensor (NTC) of the book 5 U phase IGBT.		
F337 ⁽¹⁰⁾ Overtemperature at IGBT U B5	Overtemperature fault measured with the temperature sensor (NTC) of the book 5 U phase IGBT.		
A339 ⁽¹⁰⁾ High Temperature at IGBT V B5	High temperature alarm measured with the temperature sensor (NTC) of the book 5 V phase IGBT.		
F340 ⁽¹⁰⁾ Overtemperature at IGBT V B5	Overtemperature fault measured with the temperature sensor (NTC) of the book 5 V phase IGBT.		
A342 ⁽¹⁰⁾ High Temperature at IGBT W B5	High temperature alarm measured with the temperature sensor (NTC) of the book 5 W phase IGBT.		
F343 ⁽¹⁰⁾ Overtemperature at IGBT W B5	Overtemperature fault measured with the temperature sensor (NTC) of the book 5 W phase IGBT.		
A345 ⁽¹⁰⁾ High Load at IGBT U B1	Overload alarm at book 1 U phase IGBT.		<input checked="" type="checkbox"/> High current at the inverter output (see figure 8.1 of the CFW-11M user's manual).
F346 ⁽¹⁰⁾ Overload at IGBT U B1	Overload fault at book 1 U phase IGBT.		
A348 ⁽¹⁰⁾ High Load at IGBT V B1	Overload alarm at book 1 V phase IGBT.		
F349 ⁽¹⁰⁾ Overload at IGBT V B1	Overload fault at book 1 V phase IGBT.		
A351 ⁽¹⁰⁾ High Load at IGBT W B1	Overload alarm at book 1 W phase IGBT.		
F352 ⁽¹⁰⁾ Overload at IGBT W B1	Overload fault at book 1 W phase IGBT.		
A354 ⁽¹⁰⁾ High Load at IGBT U B2	Overload alarm at book 2 U phase IGBT.		
F355 ⁽¹⁰⁾ Overload at IGBT U B2	Overload fault at book 2 U phase IGBT.		

(*) Temperature > 40 °C or 45 °C, depending on the model. Refer to the section 3.1 - Installation Environment, of the CFW-11M user's manual.

Fault/Alarm	Description	Possible Causes
A357 ⁽¹⁰⁾ High Load at IGBT V B2	Overload alarm at book 2 V phase IGBT.	<input checked="" type="checkbox"/> High current at the inverter output (see figure 8.1 of the CFW-11M user's manual).
F358 ⁽¹⁰⁾ Overload at IGBT V B2	Overload fault at book 2 V phase IGBT.	
A360 ⁽¹⁰⁾ High Load at IGBT W B2	Overload alarm at book 2 W phase IGBT.	
F361 ⁽¹⁰⁾ Overload at IGBT W B2	Overload fault at book 2 W phase IGBT.	
A363 ⁽¹⁰⁾ High Load at IGBT U B3	Overload alarm at book 3 U phase IGBT.	
F364 ⁽¹⁰⁾ Overload at IGBT U B3	Overload fault at book 3 U phase IGBT.	
A366 ⁽¹⁰⁾ High Load at IGBT V B3	Overload alarm at book 3 V phase IGBT.	
F367 ⁽¹⁰⁾ Overload at IGBT V B3	Overload fault at book 3 V phase IGBT.	
A369 ⁽¹⁰⁾ High Load at IGBT W B3	Overload alarm at book 3 W phase IGBT.	
F370 ⁽¹⁰⁾ Overload at IGBT W B3	Overload fault at book 3 W phase IGBT.	
A372 ⁽¹⁰⁾ High Load at IGBT U B4	Overload alarm at book 4 U phase IGBT.	
F373 ⁽¹⁰⁾ Overload at IGBT U B4	Overload fault at book 4 U phase IGBT.	
A375 ⁽¹⁰⁾ High Load at IGBT V B4	Overload alarm at book 4 V phase IGBT.	
F376 ⁽¹⁰⁾ Overload at IGBT V B4	Overload fault at book 4 V phase IGBT.	
A378 ⁽¹⁰⁾ High Load at IGBT W B4	Overload alarm at book 4 W phase IGBT.	
F379 ⁽¹⁰⁾ Overload at IGBT W B4	Overload fault at book 4 W phase IGBT.	
A381 ⁽¹⁰⁾ High Load at IGBT U B5	Overload alarm at book 5 U phase IGBT.	
F382 ⁽¹⁰⁾ Overload at IGBT U B5	Overload fault at book 5 U phase IGBT.	
A384 ⁽¹⁰⁾ High Load at IGBT V B5	Overload alarm at book 5 V phase IGBT.	
F385 ⁽¹⁰⁾ Overload at IGBT V B5	Overload fault at book 5 V phase IGBT. Temperature > 40 °C or 45 °C depending on the model; refer to section 3.1 - Installation Environment, of the user's manual of the CFW-11M.	
A387 ⁽¹⁰⁾ High Load at IGBT W B5	Overload alarm at book 5 W phase IGBT.	
F388 ⁽¹⁰⁾ Overload at IGBT W B5	Overload fault at book 5 W phase IGBT.	
A390 ⁽¹⁰⁾ Current Unbalance at Phase U B1	Phase U book 1 current unbalance alarm. It indicates a 20 % unbalance in the current distribution between this phase and the smallest current of the same phase in other book, only when the current in this phase is higher than 75 % of its nominal value.	<input checked="" type="checkbox"/> Bad electric connection between the DC bus and the power unit. <input checked="" type="checkbox"/> Bad electric connection between the power unit output and the motor. Note: In case of fast acceleration or braking, one of these alarms may be indicated momentarily, disappearing after 3 seconds. This is not an indication of any anomaly in the inverter. If the alarm persists when the motor is operating at a constant speed, it is an indication of an anomaly in the current distribution among the power units.

Fault/Alarm	Description	Possible Causes
A391 ⁽¹⁰⁾ Current Unbalance at Phase V B1	Phase V book 1 current unbalance alarm. It indicates a 20 % unbalance in the current distribution between this phase and the smallest current of the same phase in other book, only when the current in this phase is higher than 75 % of its nominal value.	<input checked="" type="checkbox"/> Bad electric connection between the DC bus and the power unit. <input checked="" type="checkbox"/> Bad electric connection between the power unit output and the motor. Note: In case of fast acceleration or braking, one of these alarms may be indicated momentarily, disappearing after 3 seconds. This is not an indication of any anomaly in the inverter. If the alarm persists when the motor is operating at a constant speed, it is an indication of an anomaly in the current distribution among the power units.
A392 ⁽¹⁰⁾ Current Unbalance at Phase W B1	Phase W book 1 current unbalance alarm. It indicates a 20 % unbalance in the current distribution between this phase and the smallest current of the same phase in other book, only when the current in this phase is higher than 75 % of its nominal value.	
A393 ⁽¹⁰⁾ Current Unbalance at Phase U B2	Phase U book 2 current unbalance alarm. It indicates a 20 % unbalance in the current distribution between this phase and the smallest current of the same phase in other book, only when the current in this phase is higher than 75 % of its nominal value.	
A394 ⁽¹⁰⁾ Current Unbalance at Phase V B2	Phase V book 2 current unbalance alarm. It indicates a 20 % unbalance in the current distribution between this phase and the smallest current of the same phase in other book, only when the current in this phase is higher than 75 % of its nominal value.	
A395 ⁽¹⁰⁾ Current Unbalance at Phase W B2	Phase W book 2 current unbalance alarm. It indicates a 20 % unbalance in the current distribution between this phase and the smallest current of the same phase in other book, only when the current in this phase is higher than 75 % of its nominal value.	
A396 ⁽¹⁰⁾ Current Unbalance at Phase U B3	Phase U book 3 current unbalance alarm. It indicates a 20 % unbalance in the current distribution between this phase and the smallest current of the same phase in other book, only when the current in this phase is higher than 75 % of its nominal value.	
A397 ⁽¹⁰⁾ Current Unbalance at Phase V B3	Phase V book 3 current unbalance alarm. It indicates a 20 % unbalance in the current distribution between this phase and the smallest current of the same phase in other book, only when the current in this phase is higher than 75 % of its nominal value.	
A398 ⁽¹⁰⁾ Current Unbalance at Phase W B3	Phase W book 3 current unbalance alarm. It indicates a 20 % unbalance in the current distribution between this phase and the smallest current of the same phase in other book, only when the current in this phase is higher than 75 % of its nominal value.	
A399 ⁽¹⁰⁾ Current Unbalance at Phase U B4	Phase U book 4 current unbalance alarm. It indicates a 20 % unbalance in the current distribution between this phase and the smallest current of the same phase in other book, only when the current in this phase is higher than 75 % of its nominal value.	
A400 ⁽¹⁰⁾ Current Unbalance at Phase V B4	Phase V book 4 current unbalance alarm. It indicates a 20 % unbalance in the current distribution between this phase and the smallest current of the same phase in other book, only when the current in this phase is higher than 75 % of its nominal value.	
A401 ⁽¹⁰⁾ Current Unbalance at Phase W B4	Phase W book 4 current unbalance alarm. It indicates a 20 % unbalance in the current distribution between this phase and the smallest current of the same phase in other book, only when the current in this phase is higher than 75 % of its nominal value.	

Fault/Alarm	Description	Possible Causes
A402 ⁽¹⁰⁾ Current Unbalance at Phase U B5	Phase U book 5 current unbalance alarm. It indicates a 20 % unbalance in the current distribution between this phase and the smallest current of the same phase in other book, only when the current in this phase is higher than 75 % of its nominal value.	<ul style="list-style-type: none"> <input checked="" type="checkbox"/> Bad electric connection between the DC bus and the power unit. <input checked="" type="checkbox"/> Bad electric connection between the power unit output and the motor. <p>Note: In case of fast acceleration or braking, one of these alarms may be indicated momentarily, disappearing after 3 seconds. This is not an indication of any anomaly in the inverter. If the alarm persists when the motor is operating at a constant speed, it is an indication of an anomaly in the current distribution among the power units.</p>
A403 ⁽¹⁰⁾ Current Unbalance at Phase V B5	Phase V book 5 current unbalance alarm. It indicates a 20 % unbalance in the current distribution between this phase and the smallest current of the same phase in other book, only when the current in this phase is higher than 75 % of its nominal value.	
A404 ⁽¹⁰⁾ Current Unbalance at Phase W B5	Phase W book 5 current unbalance alarm. It indicates a 20 % unbalance in the current distribution between this phase and the smallest current of the same phase in other book, only when the current in this phase is higher than 75 % of its nominal value.	
F406 ⁽¹⁰⁾ Overtemperature Brake Module	Indications related to the settings of parameters P0832 and P0833.	<ul style="list-style-type: none"> <input checked="" type="checkbox"/> Braking module cooling failure. <input checked="" type="checkbox"/> The load inertia is too high or the deceleration ramp is too fast. <input checked="" type="checkbox"/> The load at the motor shaft is too high.
F408 ⁽¹⁰⁾ Refrigeration System Fault		<ul style="list-style-type: none"> <input checked="" type="checkbox"/> Pump failure (water-cooled drive systems). <input checked="" type="checkbox"/> Cabinet ventilation failure. <p>Note: Check the fan control system used in the application.</p>
F410 ⁽¹⁰⁾ IPS External Fault		<ul style="list-style-type: none"> <input checked="" type="checkbox"/> Open DIM1 or DIM2. Check the fan control system used in the application.
F412 ⁽¹⁰⁾ Rectifier Overtemperature		<ul style="list-style-type: none"> <input checked="" type="checkbox"/> High rectifier surrounding temperature (> 45 °C (113 °F)) and high output current. <input checked="" type="checkbox"/> Rectifier cooling problem. <input checked="" type="checkbox"/> Very dirty rectifier heatsink.
F414 ⁽¹⁰⁾ External Rectifier Fault		<ul style="list-style-type: none"> <input checked="" type="checkbox"/> Undervoltage or phase loss at the rectifier input. <input checked="" type="checkbox"/> Voltage imbalance at the rectifier input > 5 %. <input checked="" type="checkbox"/> Incorrect UR11 unit DIP-switches settings.
A415 ⁽¹⁰⁾ External Rectifier High Temperature	Indications related to the settings of parameters P0832 and P0833.	<ul style="list-style-type: none"> <input checked="" type="checkbox"/> High rectifier surrounding temperature (> 45 °C (113 °F)) and high output current. <input checked="" type="checkbox"/> Very dirty rectifier heatsink.
A700 ⁽¹¹⁾ Detached HMI	Alarm or fault related to the HMI disconnection.	<input checked="" type="checkbox"/> RTC function block has been activated in the applicative and the HMI is disconnected from the inverter.
F701 ⁽¹¹⁾ Detached HMI		
A702 ⁽¹¹⁾ Inverter Disabled	Alarm indicating that the General Enable command is not active.	<input checked="" type="checkbox"/> The SoftPLC Run/Stop command is equal to Run or a movement block has been enable while the inverter is general disabled.
A704 ⁽¹¹⁾ Two Movements Enabled	Two movements have been enabled.	<input checked="" type="checkbox"/> It occurs when two or more movement blocks are enabled simultaneously.
A706 ⁽¹¹⁾ Speed Reference Not Programmed for SoftPLC	Speed reference not programmed for SoftPLC.	<input checked="" type="checkbox"/> It occurs when a movement block has been enabled and the speed reference has not been configured for SoftPLC (check P0221 and P0222).
A708 SPLC Application Stopped	SoftPLC application not running.	<ul style="list-style-type: none"> <input checked="" type="checkbox"/> SoftPLC application stopped (P1001 = 0 and P1000 = 3). <input checked="" type="checkbox"/> SoftPLC state presents incompatible application with the CFW11 firmware version.
A709 SPLC Application Stopped	SoftPLC application not running.	<ul style="list-style-type: none"> <input checked="" type="checkbox"/> SoftPLC application stopped (P1001 = 0 and P1000 = 3). <input checked="" type="checkbox"/> SoftPLC state presents incompatible application with the CFW11 firmware version.
A711 Fault in the Execution of the SoftPLC	Fault in the execution of the SoftPLC. ⁽¹⁵⁾	<ul style="list-style-type: none"> <input checked="" type="checkbox"/> Incompatible applicative. <input checked="" type="checkbox"/> Fault during upload of the applicative. <input checked="" type="checkbox"/> The program generated with old version of the WLP.

Models where they can occur:

- (1) All the models from frame size A to G.
- (2) CFW110086T2, CFW110105T2, CFW110045T4, CFW110058T4, CFW110070T4 and CFW110088T4, CFW110022T5, CFW110027T5, CFW110032T5, CFW110044T5, other models only in frame size H.
- (3) All the models of frame sizes D and E.
- (4) All the models of frame sizes A, B and C.
- (5) With a Profibus DB module connected into the slot 3 (XC43).
- (6) CFW110370T4, CFW110477T4, CFW11XXXXT6 in frame size F and all the frame size G models.
- (7) All the models of the frame size G.
- (8) All the models of the frame size E.
- (9) With IOE-01 (02 or 03) modules connected into the slot 1 (XC41).
- (10) All the models of the CFW-11M.
- (11) All the models with a SoftPLC applicative.
- (12) All the models of frame sizes F and G.
- (13) All the models of frame sizes D, E, F, G and CFW-11M.
- (14) Long motor cables (with more than 100 meters) (328.08 ft) will have a high leakage capacitance to the ground. The circulation of leakage currents through these capacitances may activate the ground fault protection after the inverter is enabled, and consequently, the occurrence of fault F074.
Possible solution:
 - To reduce the switching frequency (P0297).
 - Installation of output reactance between the motor and the inverter.
- (15) Manual available for download on the website: www.weg.net.

**NOTE!**

The range from P0750 to P0799 is destined to the SoftPLC applicative user faults and alarms.

1 SAFETY INSTRUCTIONS

This Manual contains the information necessary for the correct use of the CFW-11 frequency inverter.

It has been developed to be used by qualified personnel with suitable training or technical qualification for operating this type of equipment.

1.1 SAFETY WARNINGS IN THIS MANUAL

The following safety warnings are used in this manual:

**DANGER!**

The procedures recommended in this warning have the purpose of protecting the user against dead, serious injuries and considerable material damage.

**ATTENTION!**

The procedures recommended in this warning have the purpose of avoiding material damage.

**NOTE!**

The information mentioned in this warning is important for the proper understanding and good operation of the product.

1.2 SAFETY WARNINGS ON THE PRODUCT

The following symbols are attached to the product, serving as safety notices:



High voltages are present.



Components sensitive to electrostatic discharge.
Do not touch them.



Mandatory connection to the protective earth (PE).



Connection of the shield to the ground.



Hot surface.

1.3 PRELIMINARY RECOMMENDATIONS



DANGER!

Only qualified personnel familiar with the CFW-11 frequency inverter and associated equipment should plan or implement the installation, start-up and subsequent maintenance of this equipment. These personnel must follow all the safety instructions included in this Manual and/or defined by local regulations.

Failure to comply with these instructions may result in life threatening and/or equipment damage.



NOTE!

For the purposes of this manual, qualified personnel are those trained to be able to:

1. Install, ground, energize and operate the CFW-11 according to this manual and the effective legal safety procedures.
2. Use protection equipment according to the established standards.
3. Give first aid services.



DANGER!

Always disconnect the input power before touching any electrical component associated to the inverter. Many components can remain charged with high voltages or remain in movement (fans) even after that AC power is disconnected or switched off.

Wait at least 10 minutes before handling the equipment to assure a total discharge of the capacitors. Always connect the equipment frame to the protection earth (PE) at the suitable connection point.



ATTENTION!

Electronic boards have components sensitive to electrostatic discharges. Do not touch directly on components or connectors. If necessary, touch the grounded metallic frame before or use an adequate grounded wrist strap.

**Do not perform any high pot tests with the inverter!
If it is necessary consult WEG.**



NOTE!

Frequency Inverter may interfere with other electronic equipment. In order to reduce these effects, take the precautions recommended in the chapter 3 - Installation and Connections, of the user's manual.



NOTE!

Read the user's manual completely before installing or operating the inverter.

2 GENERAL INFORMATION

2.1 ABOUT THIS MANUAL

This manual presents the necessary information for the configuration of all of the functions and parameters of the CFW-11 frequency inverter. This manual must be used together with the CFW-11 user's manual.



The text intends to supply additional information to facilitate the use and programming of the CFW-11 in specific applications.

2.2 TERMINOLOGY AND DEFINITIONS

2.2.1 Terms and Definitions Used in the Manual

Normal Duty Cycle (ND): It is the inverter operation regimen that defines the maximum current value for continuous operation I_{nom-ND} and overload of 110 % during 1 minute. It is selected by programming P0298 (Application) = 0 (Normal Duty – ND). It must be used for driving motors that are not subject in that application to high torques in relation to their rated torque, when operating in permanent regimen, during start, acceleration or deceleration.

I_{nom-ND} : Inverter rated current for use with normal overload regimen (ND = Normal Duty).
Overload: $1.1 \times I_{nom-ND} / 1 \text{ minute}$.

Heavy Duty Cycle (HD): It is the inverter operation regimen that defines the maximum current value for continuous operation I_{nom-HD} and overload of 150 % during 1 minute. It is selected by programming P0298 (Application) = 1 (Heavy Duty (HD)). It must be used for driving motors that are subject in that application to high overload torques in relation to their rated torque, when operating in constant speed, during start, acceleration or deceleration.

I_{nom-HD} : Inverter rated current for use with heavy overload regimen (HD = Heavy Duty).
Overload: $1.5 \times I_{nom-HD} / 1 \text{ minute}$.

Nsync: Motor synchronous speed in revolutions per minute.

Rectifier: The input circuit of the inverters that converts the input AC voltage into DC. It is formed by power diodes.

Pre-charge Circuit: It charges the DC Link capacitors with a limited current, thus avoiding current peaks when powering the inverter.

DC Link: This is the inverter intermediate circuit, with DC voltage and current, obtained from the rectification of the AC supply voltage, or from an external source; it supplies the output IGBTs inverter bridge.

U, V and W Arm: It is a set of two IGBTs of the phases U, V and W at the inverter output.

IGBT: "Insulated Gate Bipolar Transistor". It is the basic component of the output inverter bridge. It operates like an electronic switch in the saturated (closed switch) and cut (open switch) modes.

Braking IGBT: Operates as a switch for the activation of the braking resistor. It is commanded by the DC Link level.

PTC: It's a resistor whose resistance value in ohms increases proportionally to the increase of the temperature; it is used as a temperature sensor in motors.

NTC: It's a resistor whose resistance value in ohms decreases proportionally to the temperature increase; it is used as a temperature sensor in power modules.

Keypad (HMI): Human-Machine Interface; It is the device that allows the control of the motor, the visualization and the modification of the inverter parameters. It presents keys for commanding the motor, navigation keys and a graphic LCD display.

MMF (Flash Memory Module): It is the nonvolatile memory that can be electrically written and erased.

RAM Memory: Random Access Memory (volatile).

USB: "Universal Serial Bus"; it is a type of connection in the perspective of the "Plug and Play" concept.





PE: "Protective Earth".

RFI Filter: "Radio Frequency Interference Filter". It is a filter that avoids interference in the radiofrequency range.

PWM: "Pulse Width Modulation". It is a pulsing voltage that supplies the motor.

Switching Frequency: It is the inverter bridge IGBTs commutation frequency, specified normally in kHz.

General Enable: When activated, it accelerates the motor with the acceleration ramp provided Run/Stop=Run. When deactivated, the PWM pulses are immediately blocked. It can be commanded through digital input programmed for that function or via serial.

Run/Stop: Inverter function that when activated (Run) accelerates the motor with the acceleration ramp until reaching the speed reference, and when deactivated (Stop) decelerates the motor with the deceleration ramp down to stop. It can be commanded through digital input programmed for that function or via serial. The HMI keys  and  work in a similar manner:
 = Run,  = Stop.

Heatsink: It is a metal part designed for dissipating the heat generated by the power semiconductors.

Amp, A: Ampere.

°C: Degrees Celsius.

AC: Alternating Current.

DC: Direct Current.

CFM: "Cubic Feet per Minute"; it is a flow measurement unit.

hp: "Horse Power" = 746 Watts (power measurement unit, normally used to indicate the mechanical power of electric motors).

Hz: Hertz.

l/s: liters per second.

kg: kilogram = 1000 gram.

kHz: kilohertz = 1000 Hz.

mA: milliamp = 0.001 Amp.

min: minute.

ms: millisecond = 0.001 second.

Nm: newton meter; torque measurement unit.

rms: "Root Mean Square"; effective value.

rpm: revolutions per minute: speed measurement unit.

s: second.

V: volt.

Ω: ohm.

2.2.2 Numerical Representation

The decimal numbers are represented by means of digits without suffix. Hexadecimal numbers are represented with the letter "h" after the number.

2.2.3 Symbols for the Parameter Properties Description

RO	Reading only parameter.
CFG	Parameter that can be changed only with a stopped motor.
V/f	Parameter visible on the keypad (HMI) only in the V/f mode: P0202 = 0, 1 or 2.
Adj	Parameter visible on the keypad (HMI) only in the V/f adjustable mode: P0202 = 2.
Vector	Parameter visible on the keypad (HMI) only in the vector modes with encoder or sensorless: P0202 = 3 or 4.
VVW	Parameter visible on the keypad (HMI) only in the VVW mode: P0202 = 5.
Sless	Parameter visible on the keypad (HMI) only in the vector sensorless mode: P0202 = 3.
Encoder	Parameter visible on the keypad (HMI) only in the vector with encoder mode: P0202 = 4.
CFW-11M	Parameter visible on the keypad (HMI) only when available in the Modular Drive.
PM	Parameter visible on the HMI only in the control modes P0202 = 6 or 7.

3 ABOUT THE CFW-11

3.1 ABOUT THE CFW-11

The CFW-11 is a high performance Frequency Inverter that makes it possible the control of speed and torque of three-phase AC induction motors. The principal characteristic of this product is the "Vectrue" technology, which presents the following advantages:

- ☑ Scalar Control (V/f), VVW or vector control programmable in the same product.
- ☑ The Vector control can be programmed as "sensorless" (which means that standard motors, without the need of encoder) or vector control with motor encoder.
- ☑ The "sensorless" vector control allows high torque and fast response, even at very slow speeds or during starting.
- ☑ The "Optimal Braking" function for the vector control allows a controlled motor braking, eliminating in some applications the braking resistor.
- ☑ The vector control "Self-Tuning" function allows the automatic setting of the regulators and control parameters, from the identification (also automatic) of the motor and load parameters.

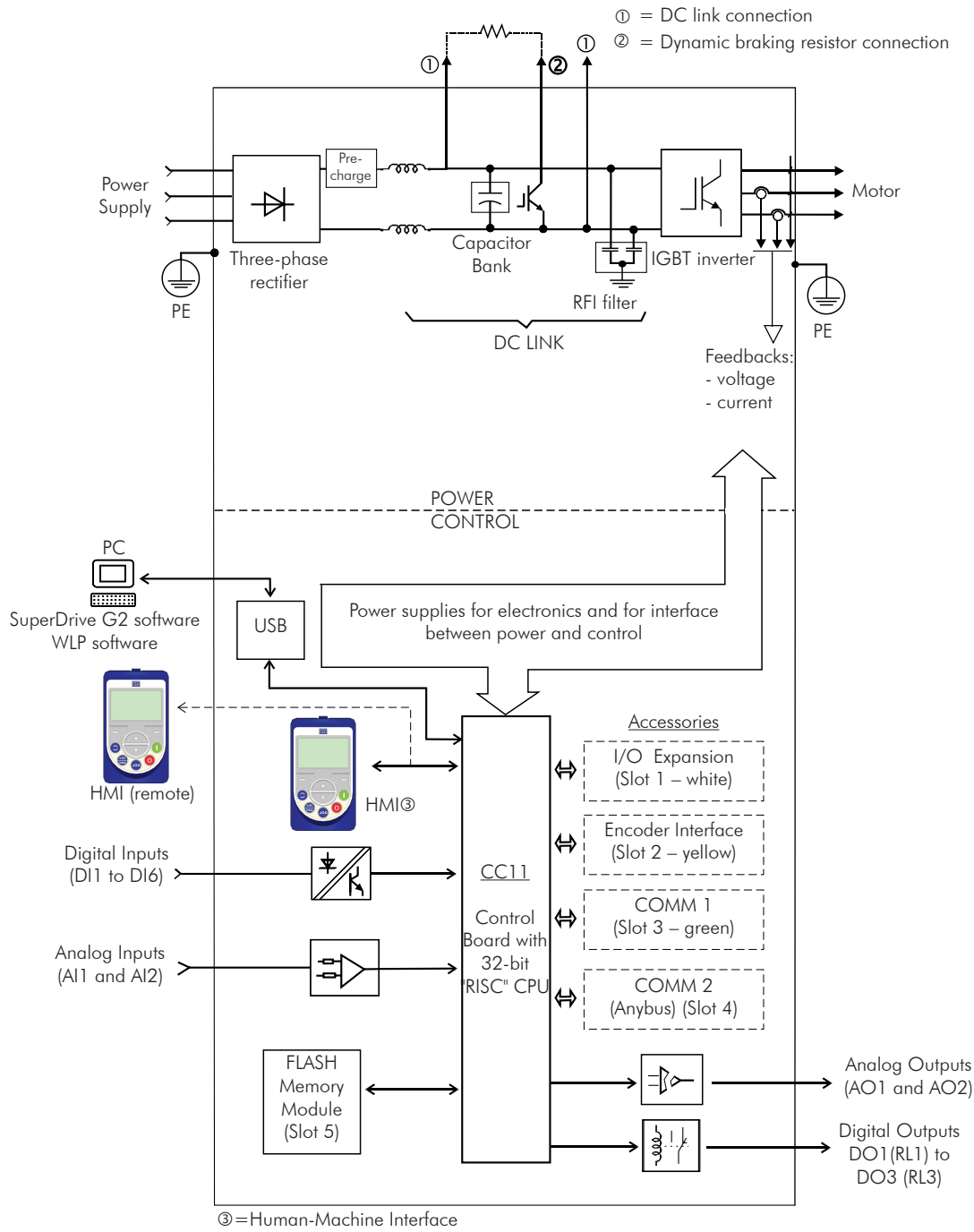

Figure 3.1 - CFW-11 block diagram

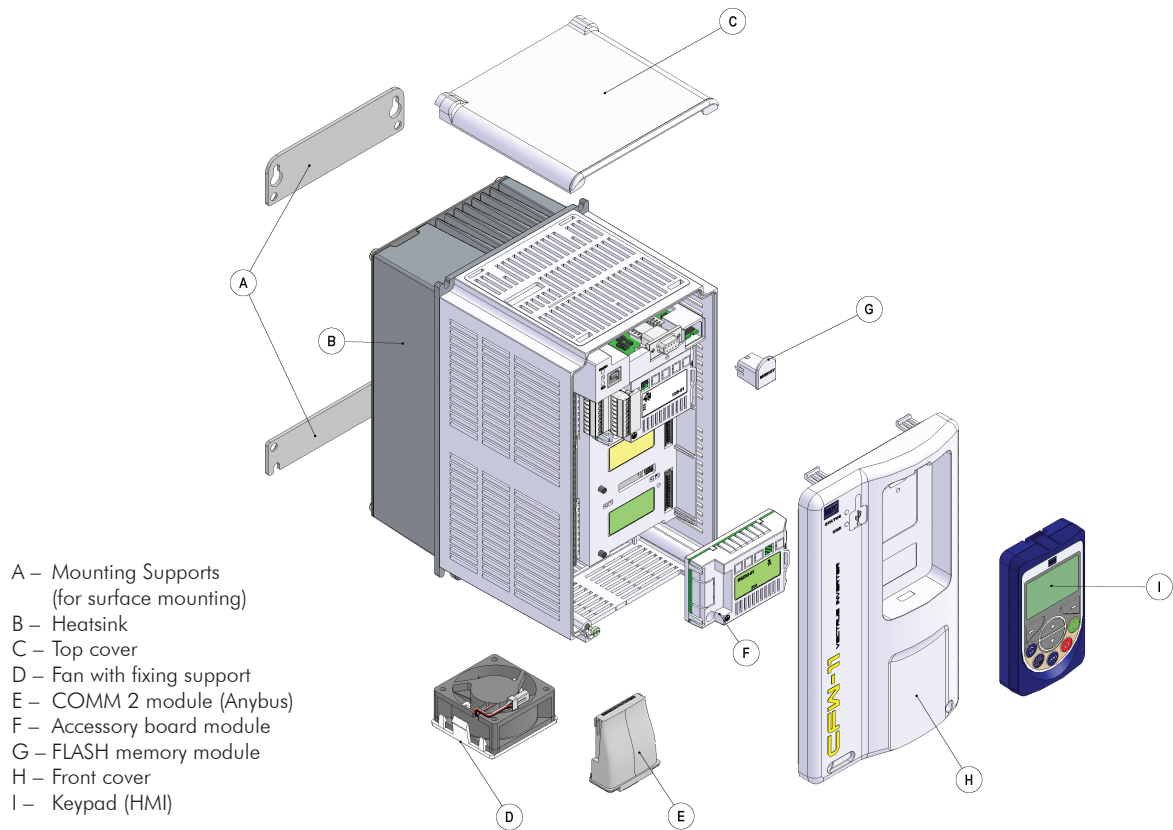

Figure 3.2 - CFW-11 main components

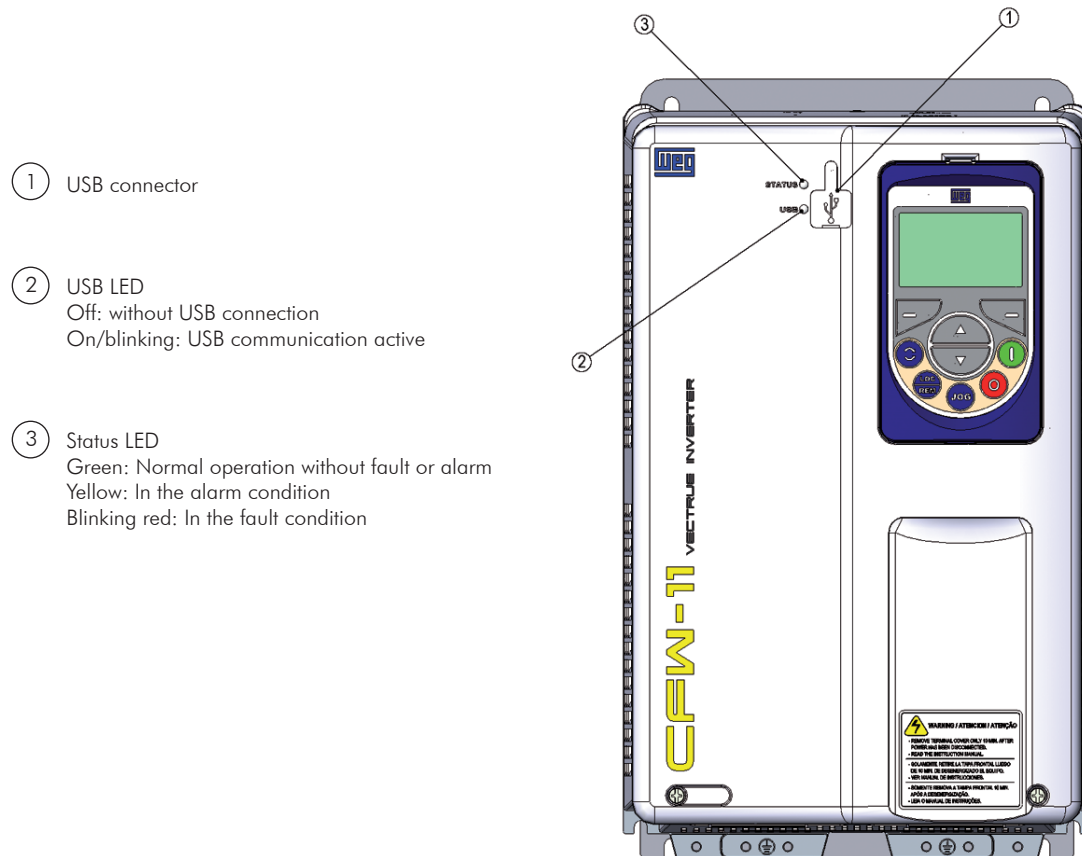

Figure 3.3 - LEDs and USB connector

4 KEYPAD (HMI)

4.1 KEYPAD (HMI)

Through the keypad (HMI) it is possible to command the inverter, visualize and adjust all the parameters. It presents a navigation manner similar to the one used in cell phones, with options to access the parameters sequentially or by means of groups (menu).

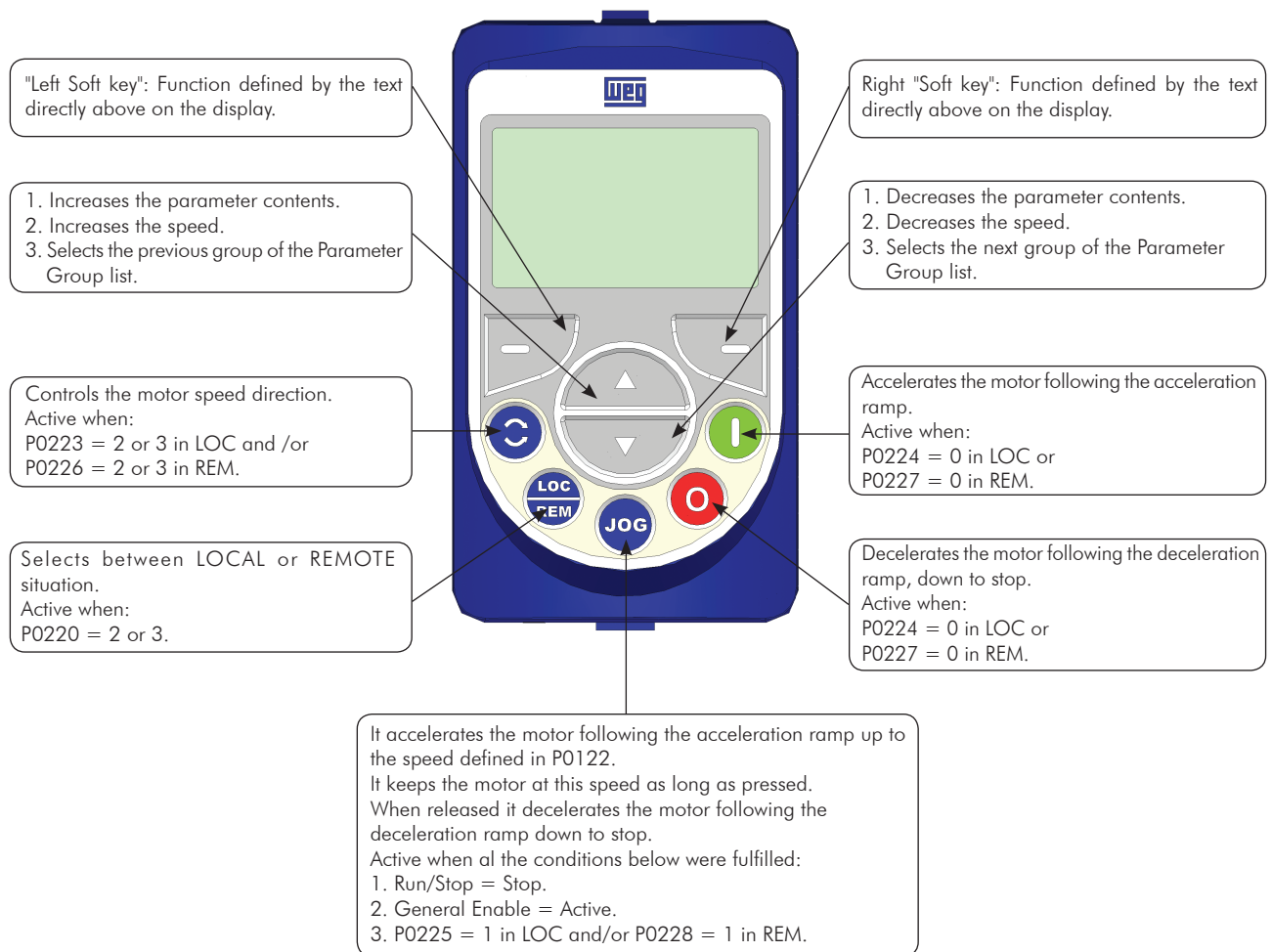

Figure 4.1 - HMI keys

Battery:

The life expectation of the battery is of approximately 10 years. In order to remove it rotate the cover located at the back of the keypad (HMI). Replace the battery, when necessary, by another of the CR2032 type.



NOTE!

The battery is necessary only for clock-related functions. In the event of the battery being discharged or not installed in the keypad (HMI), the clock time becomes incorrect and the alarm A181 – "Invalid clock value" will be indicated every time the inverter is powered.



Cover for battery access



Press the cover and rotate it counterclockwise



Remove the cover



Remove the battery with the help of a screwdriver positioned in the right side



HMI without the battery



Install the new battery positioning it first at the left side

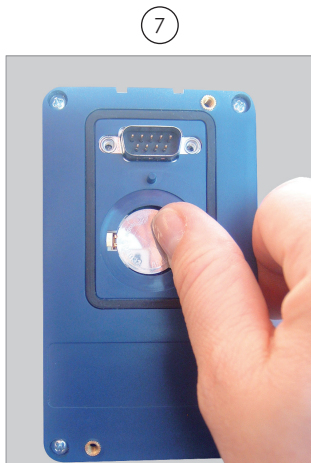

Press the battery for its insertion



Put the cover back and rotate it clockwise

Figure 4.2 - HMI battery replacement



NOTE!

At the end of the battery useful life, please do not discard batteries in your waste container, but use a battery disposal site.

5 PROGRAMMING BASIC INSTRUCTIONS

5.1 PARAMETER STRUCTURE

When the right "soft key" in the monitoring mode ("Menu") is pressed, the first 4 parameter groups are showed on the display. An example of the parameter group structure is presented in the [Table 5.1 on page 5-1](#). The number and the name of the groups may change depending on the used software version.



NOTE!

The inverter leaves the factory with the keypad (HMI) language, frequency (V/f 50/60 Hz mode) and voltage adjusted according to the market.

The reset to the factory default may change the content of the parameters related to the frequency (50 Hz/60 Hz). In the detailed description, some parameters present values in parentheses, which must be adjusted in the inverter for using the 50 Hz frequency.

Table 5.1 - CFW-11 parameter groups structure

Level 0	Level 1	Level 2	Level 3	
Monitoring	00 ALL PARAMETERS			
	01 PARAMETER GROUPS	20 Ramps		
		21 Speed References		
		22 Speed Limits		
		23 V/f Control		
		24 Adjust. V/f Curve		
		25 V/W Control		
		26 V/f Current Limit.		
		27 V/f DC Volt.Limit.		
		28 Dynamic Braking		
		29 Vector Control		90 Speed Regulator
				91 Current Regulator
				92 Flux Regulator
				93 I/F Control
				94 Self-Tuning
				95 Torque Curr.Limit.
				96 DC Link Regulator
			30 HMI	
			31 Local Command	
			32 Remote Command	
			33 3-Wire Command	
			34 FWD/REV Run Comm.	
			35 Zero Speed Logic	
			36 Multispeed	
			37 Electr. Potentiom.	
			38 Analog Inputs	
			39 Analog Outputs	
			40 Digital Inputs	
			41 Digital Outputs	
			42 Inverter Data	
			43 Motor Data	
			44 FlyStart/RideThru	
			45 Protections	
			46 PID Regulator	
			47 DC Braking	
			48 Skip Speed	
			49 Communication	110 Local/Rem Config.
				111 Status/Commands
				112 CANopen/DeviceNet
				113 Serial RS232/485
				114 Anybus
				115 Profibus DP
			50 SoftPLC	
			51 PLC	
			52 Trace Function	
			53 Energy Saving	
			02 ORIENTED START-UP	
			03 CHANGED PARAMETERS	
			04 BASIC APPLICATION	
			05 SELF-TUNING	
		06 BACKUP PARAMETERS		
		07 I/O CONFIGURATION	38 Analog Inputs	
			39 Analog Outputs	
	40 Digital Inputs			
	41 Digital Outputs			
	08 FAULT HISTORY			
	09 READ ONLY PARAMS.			

5.2 GROUPS ACCESSED IN THE OPTION MENU IN THE MONITORING MODE

In the monitoring mode access the groups of the option "Menu" by pressing the right "soft key".

Table 5.2 - Parameter groups accessed in the option menu of the monitoring mode

Group		Contained parameters or groups
00	ALL PARAMETERS	All the parameters
01	PARAMETER GROUPS	Access to groups divided by functions
02	ORIENTED START-UP	Parameter for entering the "Oriented Start-up" mode
03	CHANGED PARAMETERS	Only parameters whose contents are different from the factory settings
04	BASIC APPLICATION	Parameters for simple applications: ramps, minimum and maximum speed, maximum current and torque boost. Presented in details in the CFW-11 user's manual at section 5.2.3 - Setting Basic Application Parameters
05	SELF-TUNING	Access parameter (P0408) and estimated parameters
06	BACKUP PARAMETERS	Parameters related to functions of parameter copy via FLASH Memory Module, keypad (HMI) and software update
07	I/O CONFIGURATION	Groups related to digital and analog, inputs and outputs
08	FAULT HISTORY	Parameters with information on the 10 last faults
09	READ ONLY PARAMS.	Parameters used only for reading

5.3 PASSWORD SETTING IN P0000

P0000 – Access to Parameters

Adjustable Range:	0 to 9999	Factory Setting:	0
Properties:			
Access groups via HMI:	00 ALL PARAMETERS		

In order to be able to change the content of the parameters, it is necessary to set correctly the password in P0000, as indicated below. Otherwise the content of the parameters can only be visualized.

It is possible to customize the password by means of P0200. Refer to the description of this parameter in the [Section 5.4 HMI \[30\] on page 5-4](#), of this manual.

Seq.	Action/Result	Display Indication
1	- Monitoring Mode. - Press "Menu" (right "soft key").	
2	- The group "00 ALL PARAMETERS" is already selected. - Press "Select".	
3	- The parameter "Access to Parameters P0000: 0" is already selected. - Press "Select".	
4	- In order to set the password, press until the number 5 appears on the display.	
5	- When the number 5 appears, press "Save".	
6	- If the setting was performed correctly, the display must show "Access to Parameters P0000: 5". - Press "Return" (left "soft key").	
7	- Press "Return".	
8	- The display returns to the Monitoring Mode.	

Figure 5.1 - Sequence for allowing parameter changes via P0000

5.4 HMI [30]

In the group "30 HMI" are the parameters related to the presentation of information on the keypad (HMI) display. See next the detailed description of the possible settings for those parameters.

P0193 – Day of the Week

Adjustable Range:	0 = Sunday 1 = Monday 2 = Tuesday 3 = Wednesday 4 = Thursday 5 = Friday 6 = Saturday	Factory Setting: 0
--------------------------	--	---------------------------

5

P0194 – Day

Adjustable Range:	01 to 31	Factory Setting: 01
--------------------------	----------	----------------------------

P0195 – Month

Adjustable Range:	01 to 12	Factory Setting: 01
--------------------------	----------	----------------------------

P0196 – Year

Adjustable Range:	00 to 99	Factory Setting: 06
--------------------------	----------	----------------------------

P0197 – Hour

Adjustable Range:	00 to 23	Factory Setting: 00
--------------------------	----------	----------------------------

P0198 – Minutes

P0199 – Seconds

Adjustable Range:	00 to 59	Factory Setting: P0198 = 00 P0199 = 00
--------------------------	----------	--

Properties:

Access groups via HMI:	<table border="1" style="border-collapse: collapse;"> <tr> <td style="padding: 2px;">01 PARAMETER GROUPS</td> </tr> <tr> <td style="padding: 2px;">30 HMI</td> </tr> </table>	01 PARAMETER GROUPS	30 HMI
01 PARAMETER GROUPS			
30 HMI			

Description:

Those parameters set the date and time of the CFW-11 real time clock. It is important to configure them with the correct date and time so that the fault and alarm record occurs with actual date and time information.

P0200 – Password

Adjustable Range:	0 = Off 1 = On 2 = Change Password	Factory Setting: 1
Properties:		
Access groups via HMI:	01 PARAMETER GROUPS 30 HMI	

Description:

It allows changing the password and/or setting its status, configuring it as active or inactive. For more details on each option, refer to the [Table 5.3 on page 5-5](#) described next.

Table 5.3 - Options for the parameter P0200

P0200	Kind of Action
0 (Inactive)	It allows parameter changes via HMI regardless of P0000
1 (Active)	It does only allow parameter changes via HMI when the content of P0000 is equal to the password
2 (Changed Password)	It opens a window for changing the password

When the option 2 is selected (Change password), the inverter opens a window for changing the password, allowing the selection of a new value for it.

P0201 – Language

Adjustable Range:	0 = Português 1 = English 2 = Español 3 = Deutsche 4 = Français	Factory Setting: 0
Properties:		
Access groups via HMI:	01 PARAMETER GROUPS 30 HMI	

Description:

It determines the language in which information will be presented on the keypad (HMI).

P0205 – Reading Parameter Selection 1

P0206 – Reading Parameter Selection 2

P0207 – Reading Parameter Selection 3

5

Adjustable Range:	0 = Not selected	Factory Setting: P0205 = 2 P0206 = 3 P0207 = 5
	1 = Speed Reference #	
	2 = Motor Speed #	
	3 = Motor Current #	
	4 = DC Link Voltage #	
	5 = Motor Frequency #	
	6 = Motor Voltage #	
	7 = Motor Torque #	
	8 = Output Power #	
	9 = Process Variable #	
	10 = Setpoint PID #	
	11 = Speed Reference -	
	12 = Motor Speed -	
	13 = Motor Current -	
	14 = DC Link Voltage -	
	15 = Motor Frequency -	
	16 = Motor Voltage -	
	17 = Motor Torque -	
	18 = Output Power -	
	19 = Process Variable -	
	20 = Setpoint PID -	
	21 = SoftPLC P1010#	
	22 = SoftPLC P1011#	
	23 = SoftPLC P1012#	
	24 = SoftPLC P1013#	
	25 = SoftPLC P1014#	
	26 = SoftPLC P1015#	
	27 = SoftPLC P1016#	
	28 = SoftPLC P1017#	
	29 = SoftPLC P1018#	
	30 = SoftPLC P1019#	
	31 = PLC11 P1300 #	
	32 = PLC11 P1301 #	
	33 = PLC11 P1302 #	
	34 = PLC11 P1303 #	
	35 = PLC11 P1304 #	
	36 = PLC11 P1305 #	
	37 = PLC11 P1306 #	
	38 = PLC11 P1307 #	
	39 = PLC11 P1308 #	
	40 = PLC11 P1309 #	

Properties:

Access groups via HMI:	01 PARAMETER GROUPS
	30 HMI

Description:

Those parameters define which variables, and in what manner they will be shown on the keypad (HMI) display in the monitoring mode.

The options that present the symbol "#" at the end indicate that the variable will be displayed in absolute numerical values. The options ended with the symbol "-", configure the variable to be displayed as a bar graph, in percentage values. More details on this programming can be seen in the [Section 5.6 DISPLAY INDICATIONS IN THE MONITORING MODE SETTINGS](#) on page 5-10.

P0208 – Reference Scale Factor

Adjustable Range:	1 to 18000	Factory Setting:	1800 (1500)
--------------------------	------------	-------------------------	----------------

P0212 – Reference Decimal Point

Adjustable Range:	0 = wxyz 1 = wxy.z 2 = wx.yz 3 = w.xyz	Factory Setting:	0
--------------------------	---	-------------------------	---

Properties:

Access groups via HMI:	01 PARAMETER GROUPS 30 HMI
-------------------------------	-------------------------------

Description:

They define how the Speed Reference (P0001) and the Motor Speed (P0002) will be presented when the motor runs at the synchronous speed.

In order to indicate the value **in rpm**, P0208 must be adjusted at the motor synchronous speed according to the [Table 5.4 on page 5-7](#):

Table 5.4 - Synchronous speed reference in rpm

Frequency	Number of Motor Poles	Synchronous Speed in rpm
50 Hz	2	3000
	4	1500
	6	1000
	8	750
60 Hz	2	3600
	4	1800
	6	1200
	8	900

In order to indicate values in **other units**, use the following formulas:

$$P0002 = \frac{\text{Speed} \times P0208}{\text{Synchronous Speed} \times (10)^{P0212}}$$

$$P0001 = \frac{\text{Reference} \times P0208}{\text{Synchronous Speed} \times (10)^{P0212}}$$

Where,

Reference = Speed reference, in rpm.

Speed = Actual speed, in rpm.

Synchronous Speed = 120 x Motor Rated Frequency (P0403)/Nr. of Poles.

Nr. of Poles = 120 x P0403 / Motor Rated Speed (P0402), and can be equal to 2, 4, 6, 8 or 10.

Example:

If Speed = Synchronous Speed = 1800,

P0208 = 900,

P0212 = 1 (wxy.z), then

$$P0002 = \frac{1800 \times 900}{1800 \times (10)^1} = 90.0$$

P0209 – Reference Engineering Unit 1

P0210 – Reference Engineering Unit 2

P0211 – Reference Engineering Unit 3

Adjustable Range:	32 to 127	Factory Setting:	P0209 = 114 (r) P0210 = 112 (p) P0211 = 109 (m)
--------------------------	-----------	-------------------------	---

Properties:

Access groups via HMI:	01 PARAMETER GROUPS
	30 HMI

5

Description:

Those parameters are used to adjust the unit of the variable one wants to indicate at parameters P0001 and P0002. The characters "rpm" can be replaced by those wanted by the user, for instance, L/s (length/second), CFM (cubic feet per minute), etc.

The reference engineering unit is composed by 3 characters: P0209 defines the leftmost, P0210 the center and P0211 the rightmost character.

The available characters correspond to the ASCII code from 32 to 127.

Examples:

A, B, ..., Y, Z, a, b, ..., y, z, 0, 1, ..., 9, #, \$, %, (,), *, +, ...

- | | |
|---|--|
| - To indicate "L/s":
P0209="L" (76)
P0210="/" (47)
P0211="s" (115) | - To indicate "CFM":
P0209="C" (67)
P0210="F" (70)
P0211="M" (77) |
|---|--|

P0213 – Full Scale Reading Parameter 1

P0214 – Full Scale Reading Parameter 2

P0215 – Full Scale Reading Parameter 3

Adjustable Range:	0.0 to 200.0 %	Factory Setting:	100.0 %
--------------------------	----------------	-------------------------	---------

Properties:

Access groups via HMI:	01 PARAMETER GROUPS
	30 HMI

Description:

Those parameters configure the full scale of the reading variables 1, 2 and 3 (selected through P0205, P0206 and P0207), when they were programmed to be presented as bar graphs.

P0216 – HMI Display Contrast

Adjustable Range:	0 to 37	Factory Setting:	27
Properties:			
Access groups via HMI:	01 PARAMETER GROUPS		
	30 HMI		

Description:

It allows setting the keypad (HMI) display contrast level. Higher values configure a higher contrast level.

5.5 DATE AND TIME SETTING

Seq.	Action/Result	Display Indication
1	- Monitoring Mode. - Press "Menu" (right "soft key").	
2	- The group "00 ALL PARAMETERS" is already selected.	
3	- The group "01 PARAMETER GROUPS" is selected. - Press "Select".	
4	- A new list of groups is showed on the display, with the group "20 Ramps" selected. - Press [down arrow] until the group "30 HMI" is selected.	
5	- The group "30 HMI" is selected. - Press "Select".	

Seq.	Action/Result	Display Indication
6	- The parameter "Day P0194" is already selected. - If necessary, set P0194 according to the actual day. Therefore, press "Select". - For changing P0194 contents [down arrow] or [up arrow] or [right arrow] or [left arrow]. - Proceed in the same way for adjusting the parameters from "Month P0195" to "Seconds P0199".	
7	- When P0199 is finished, the Real Time Clock will be adjusted. - Press "Return" (left "soft key").	
8	- Press "Return".	
9	- Press "Return".	
10	- The display returns to the Monitoring Mode.	

Figure 5.2 - Date and time adjustment

5.6 DISPLAY INDICATIONS IN THE MONITORING MODE SETTINGS

Every time the inverter is powered the display goes to the Monitoring Mode. In order to make it easier the reading of the motor main parameters, the keypad (HMI) display can be configured to show them in 3 different modes.

Content of the 3 parameters in numerical form:

Selection of the parameters via P0205, P0206 and P0207. That mode can be seen in the [Figure 5.3 on page 5-10](#).

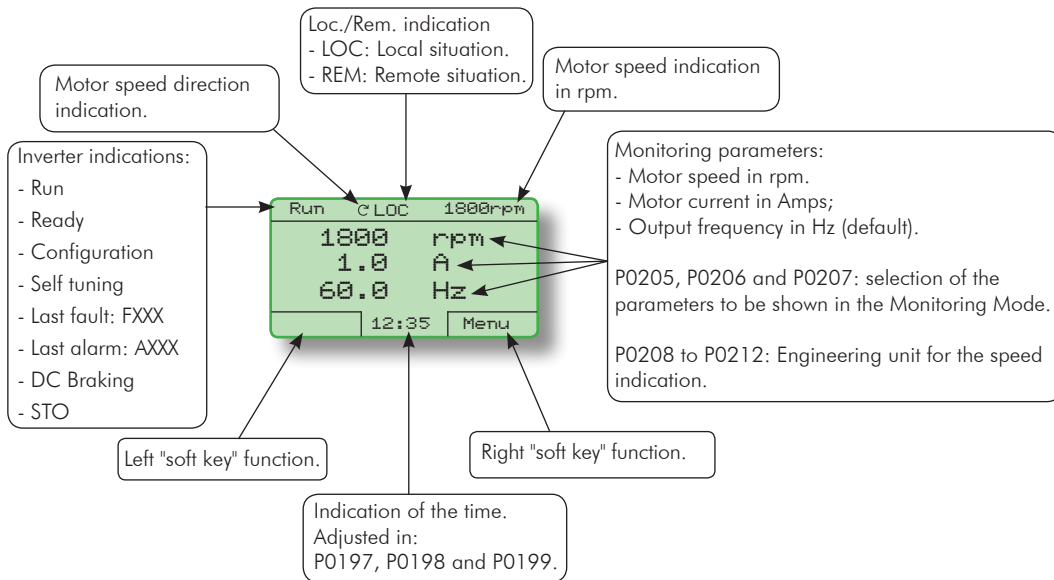

Figure 5.3 - Monitoring Mode screen at the factory setting

Content of the 3 parameters in form of a bar graph:

Selection of the parameters via P0205, P0206 and/or P0207. The values are showed in percentage by means of horizontal bars. This mode is illustrated in the [Figure 5.4 on page 5-10](#).

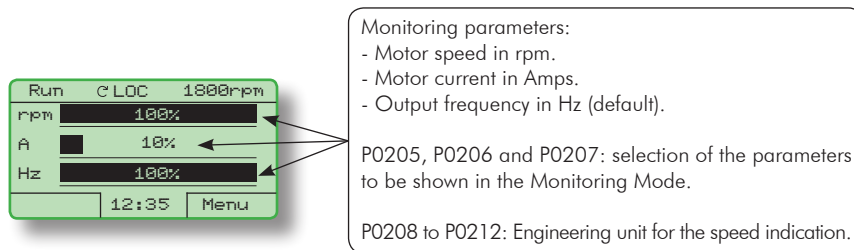

Figure 5.4 - Monitoring Mode screen with bar graphs

In order to configure the bar graph monitoring mode, access the parameters P0205, P0206 and/or P0207 and select the options ended with the symbol "-" (values in the range from 11 to 20). Thus, the respective variable is configured to be shown as a bar graph.

The [Figure 5.5 on page 5-11](#), presented next, illustrates the procedure for the modification of the display of one variable to the graph mode.

Seq.	Action/Result	Display Indication
1	- Monitoring Mode. - Press "Menu" (right "soft key").	
2	- The group "00 ALL PARAMETERS" is already selected	
3	- The group "01 PARAMETER GROUPS" is selected. - Press "Select".	
4	- A new list of groups is showed on the display, with the group "20 Ramps" selected. - Press the group "30 HMI" is selected.	
5	- The group "30 HMI" is selected. - Press "Select".	
6	- The parameter "Day P0194" is already selected. - Press until selecting "Read Parameter Sel. 1 P0205".	
7	- The "Read Parameter Sel. 1 P0205" is selected. - Press "Select".	
8	- Press until selecting the option "[11] Speed Refer. -". - Press "Save".	
9	- Press "Return".	
10	- Press "Return".	
11	- Press "Return".	
12	- The display returns to the Monitoring Mode with the speed indicated by a bar graph.	

Figure 5.5 - Monitoring with bar graph configuration

In order to return to the standard Monitoring Mode (numerical), you only have to select the options ended with "#" (values from 1 to 10) in the parameters P0205, P0206 and/or P0207.

Content of the parameter P0205 in numerical form with bigger characters:

Program the reading parameters (P0206 and P0207) in zero (inactive) and P0205 as numerical value (one option ended with "#"). Thus, P0205 starts being displayed in bigger characters. The Figure 5.6 on page 5-11 illustrates this monitoring mode.

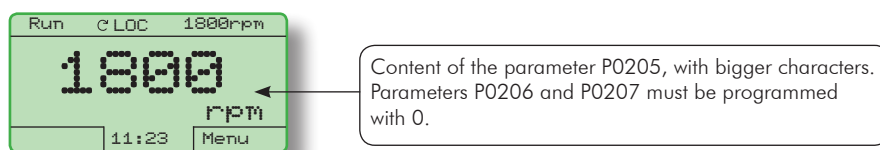





Figure 5.6 - Example of the screen in the Monitoring Mode with P0205 programmed with bigger characters

5.7 INCOMPATIBILITY BETWEEN PARAMETERS

If any of the combinations listed below occur, the CFW-11 goes to the "Config" state.

- 1) Two or more Dlx (P0263...P0270) programmed for (4 = FWD Run).
- 2) Two or more Dlx (P0263...P0270) programmed for (5 = REV Run).
- 3) Two or more Dlx (P0263...P0270) programmed for (6 = 3-Wire Start).
- 4) Two or more Dlx (P0263...P0270) programmed for (7 = 3-Wire Stop).
- 5) Two or more Dlx (P0263...P0270) programmed for (8 = FWD/REV).
- 6) Two or more Dlx (P0263...P0270) programmed for (9 = LOC/REM).
- 7) Two or more Dlx (P0263...P0270) programmed for (11 = Increase E.P.).
- 8) Two or more Dlx (P0263...P0270) programmed for (12 = Decrease E.P.).
- 9) Two or more Dlx (P0263...P0270) programmed for (14 = Ramp 2).
- 10) Two or more Dlx (P0263...P0270) programmed for (15 = Speed/Torque).
- 11) Two or more Dlx (P0263...P0270) programmed for (22 = Manual/Automatic).
- 12) Two or more Dlx (P0263...P0270) programmed for (24 = Disable Flying Start).
- 13) Two or more Dlx (P0263...P0270) programmed for (25 = DC Link Regulator).
- 14) Two or more Dlx (P0263...P0270) programmed for (26 = Programming Off).
- 15) Two or more Dlx (P0263...P0270) programmed for (27 = Load User 1/2).
- 16) Two or more Dlx (P0263...P0270) programmed for (28 = Load User 3).
- 17) Two or more Dlx (P0263...P0270) programmed for (29 = DO2 Timer).
- 18) Two or more Dlx (P0263...P0270) programmed for (30 = DO3 Timer).
- 19) Dlx (P0263...P0270) programmed for (4 = FWD Run) without Dlx (P0263...P0270) programmed for (5 = REV Run).
- 20) Dlx (P0263...P0270) programmed for (5 = REV Run) without Dlx (P0263...P0270) programmed for (4 = FWD Run).
- 21) Dlx (P0263...P0270) programmed for (6 = 3-Wire Start) without Dlx (P0263...P0270) programmed for (7 = 3-Wire Stop).
- 22) Dlx (P0263...P0270) programmed for (7 = 3-Wire Stop) without Dlx (P0263...P0270) programmed for (6 = 3-Wire Start).
- 23) P0221 or P0222 programmed for (8 = Multispeed) without Dlx (P0266...P0268) programmed for (13 = Multispeed).
- 24) P0221 or P0222 not programmed for (8 = Multispeed) with Dlx (P0266...P0268) programmed for (13 = Multispeed).

- 25) [P0221 or P0222 programmed for (7 = E.P.)] AND [without Dlx (P0263...P0270) programmed for (11 = Increase E.P.) OR without Dlx (P0263...P0270) programmed for (12 = Decrease E.P.)].
- 26) [P0221 and P0222 not programmed for (7 = E.P.)] AND [with Dlx (P0263...P0270) programmed for (11 = Increase E.P.) OR with Dlx (P0263...P0270) programmed for (12 = Decrease E.P.)].
- 27) [P0202 programmed for (0 = V/f 60Hz) OR (1 = V/f 50Hz) OR (2 = Adjustable V/f) OR (5 = VVW)] AND [P0231 = 1 (No Ramp Ref.) OR P0231 = 2 (Max.Torque Cur) OR P0236 = 1 (No Ramp Ref.) OR P0236 = 2 (Max.Torque Cur) OR P0241 = 1 (No Ramp Ref.) OR P0241 = 2 (Max.Torque Cur) OR P0246 = 1 (No Ramp Ref.) OR P0246 = 2 (Max.Torque Cur)].
- 28) [P0202 programmed for (0 = V/f 60Hz) OR (1 = V/f 50Hz) OR (2 = Adjustable V/f) OR (5 = VVW)] AND [Dlx (P0263...P0270) programmed for (16 = JOG+) OR (17 = JOG-)].
- 29) P0203 programmed for (1 = PID Regulator) AND P0217 for (1 = On) AND [P0224 programmed for (0 = ,  Keys) OR P0227 programmed for (0 = ,  Keys)].
- 30) Dlx (P0263...P0270) programmed for (29 = DO2 Timer) without DO2 (P0276) programmed for (29 = Timer).
- 31) DO2 (P0276) programmed for (29 = Timer) without Dlx (P0263...P0270) programmed for (29 = DO2 Timer).
- 32) Dlx (P0263...P0270) programmed for (30 = DO3 Timer) without DO3 (P0277) programmed for (29 = Timer).
- 33) DO3 (P0277) programmed for (29 = Timer) without Dlx (P0263...P0270) programmed for (30 = DO3 Timer).
- 34) [P0224 programmed for (1 = Dlx) OR P0227 programmed for (1 = Dlx)] AND [without Dlx (P0263...P0270) programmed for (1 = Run/Stop) AND without Dlx (P0263...P0270) programmed for (2 = General Enable) AND without Dlx (P0263...P0270) programmed for (3 = Fast Stop) AND without Dlx (P0263...P0270) programmed for (4 = FWD Run) AND without Dlx (P0263...P0270) programmed for (5 = REV Run) AND without Dlx (P0263...P0270) programmed for (6 = 3-Wire Start) AND without (P0263...P0270) programmed for (7 = 3-Wire Stop)].
- 35) P0202 set to 3 (Sensorless), 4 (Encoder), 6 (PM with encoder) or 7 (PM Sensorless) and P0297 = 0 (1.25 kHz).
- 36) P0202 set to 7 (PM Sensorless) and P0297 = 3 (10 kHz).
- 37) P0297 programmed for:
 - 3 or 4 in frame B and P0296 adjusted between 500 V and 600 V.
 - 3 or 4 in frame D and P0296 adjusted between 500 V and 690 V.
 - 1, 2 or 3 in frames E, F or G and P0296 adjusted between 500 V and 690 V, and in mechanics of the Modular Drive.
 - 1 or 3 in frames F, G and P0296 set between 380 V and 480 V.
- 38) P0586 set to 1 (energy saving function is active) and P0406 = 2 (optimal flux).

6 INVERTER MODEL AND ACCESSORIES IDENTIFICATION

In order to identify the model of the inverter, verify the code existent on the product identification labels: the complete one, located at the side of the inverter, or the abbreviated one, under the keypad (HMI). The figures below show examples of those labels.

CFW11 model → MOD.: BRCFW110242T4SZ
 WEG part number → MAT.: 11270533 MAX. TA: 45°C (113°F)
 Inverter net weight → PESO/WEIGHT: 130Kg (287lb) 20L

	LINEA REDE	OUTPUT SALIDA SAIDA
VAC	380-480V / 3~	0-REDE 3~
A (ND) 60s/3s	242A	242A / 266A / 363A
A (HD) 60s/3s	211A	211A / 317A / 422A
Hz	50/60Hz	0-300Hz

Input rated data (voltage, number of phases, rated currents for operation with ND) and HD overload regimens, and frequency) →
 Current specifications for operation with normal overload regimen (ND) →
 Current specifications for operation with heavy overload regimen (HD) →

Maximum environment temperature →
 Serial Number →
 Manufacturing date (Day-month-year) →
 Output rated data (voltage, number of phases, rated currents for normal overload regimen (ND) and heavy overload regimen (HD), overload currents for 1 min and 3 s, and frequency range) →

FABRICADO NO BRASIL
 HECHO EN BRASIL
 MADE IN BRAZIL

UL LISTED IND. CONT. EQ. 2899
 CE EAC
 7 890355 877722

(a) Identification label at the side of the inverter for the models in cabinet (CFW-11)

CFW11M model → MOD.: UP11-01 REV. C 20L
 WEG part number → MAT.: 11317219 MAX. TA: 40°C (104°F)
 Inverter net weight → PESO/WEIGHT: 171Kg (377lb)

	LINK DC	OUTPUT SALIDA SAIDA
	574-890 DC	0-0.71 VDC VAC 3~
A (ND) 60s/3s	540 A	470A / 470A
A (HD) 60s/3s	437 A	380 / 570 / 760
	758-1025 DC	0-0.71 VDC VAC 3~
A (ND) 60s/3s	490	470A / 470A
A (HD) 60s/3s	390	340 / 570 / 680
Hz	50/60 H	0-300H

Input rated data (voltage, number of phases, rated currents for operation with ND) and HD overload regimens, and frequency) →
 Current specifications for operation with normal overload regimen (ND) →
 Current specifications for operation with heavy overload regimen (HD) →

Manufacturing date (Day-month-year) →
 Maximum environment temperature →
 Serial Number →
 Output rated data (voltage, number of phases, rated currents for normal overload regimen (ND) and heavy overload regimen (HD), overload currents for 1 min and 3 s, and frequency range) →

FABRICADO NO BRASIL
 HECHO EN BRASIL
 MADE IN BRAZIL

UL LISTED IND. CONT. EQ. 2899
 CE IRAM
 7 894171 853649

(b) CFW-11M identification label which is attached inside the panel where the inverter is installed

CFW11 model → BRCFW110242T4SZ
 WEG part number → 11270533 03H
 SERIAL#: 1234567980

Manufacturing date (03 corresponds to week and H to year) →
 Serial number →

(c) Identification label under the keypad (HMI)

Figure 6.1 - (a) to (c) - Identification labels

Once the inverter model identification code is verified, one must interpret it in order to understand its meaning. Refer to the table present in the section 2.4 - Identification Labels for the CFW-11, of the CFW-11 user's manual and in the section 2.6 - How to Specify the CFW-11M Model (Smart Code), of the CFW-11M user's manual.

6.1 INVERTER DATA [42]

In this group are the parameters related to the inverter information and characteristics, such as inverter model, accessories identified by the control circuit, software version, switching frequency, etc.

P0023 – Software Version

Adjustable Range:	0.00 to 655.35	Factory Setting:
Properties:	RO	
Access groups via HMI:	01 PARAMETER GROUPS 42 Inverter Data	

6

Description:

It indicates the software version contained in the FLASH memory of the microcontroller located on the control board.

P0027 – Accessories Configuration 1

P0028 – Accessories Configuration 2

Adjustable Range:	0000h to FFFFh	Factory Setting:
Properties:	RO	
Access groups via HMI:	01 PARAMETER GROUPS 42 Inverter Data	

Description:

Those parameters identify by means of a hexadecimal code the accessories that were found installed on the control module.

For the accessories installed in the slots 1 and 2 the identification code is informed at the parameter P0027. In case of modules connected in the slots 3, 4 or 5, the code will be shown through the parameter P0028.

The [Table 6.1 on page 6-3](#) shows the codes shown in those parameters, regarding the main CFW-11 accessories.

Table 6.1 - CFW-11 accessory identification codes

Name	Description	Slot	Identification Code	
			P0027	P0028
IOA-01	Module with 2 14-bit analog inputs, 2 digital inputs, 2 14-bit analog outputs in voltage or current, 2 open collector digital outputs	1	FD--	----
IOB-01	Module with 2 isolated analog inputs, 2 digital inputs, 2 isolated analog outputs in voltage or current, 2 open collector digital outputs	1	FA--	----
IOC-01	Module with 8 isolated digital inputs and 4 relay outputs	1	C1--	
IOC-02	Module with 8 isolated digital inputs and 8 open collector type digital outputs	1	C5--	
IOC-03	Module with 8 isolated digital inputs and 7 digital outputs of 500 mA	1	C6--	----
IOE-01	PTC temperature transducer module	1	25--	
IOE-02	PT110 temperature transducer module	1	23--	
IOE-03	KTY84 temperature transducer module	1	27--	
ENC-01	Incremental encoder module 5 to 12 Vdc, 100 kHz, with encoder signal repeater	2	--C2	----
ENC-02	Incremental encoder module 5 to 12 Vdc, 100 kHz	2	--C2	----
RS-485-01	RS-485 serial communication module	3	----	CE--
RS-232-01	RS-232C serial communication module	3	----	CC--
RS-232-02	RS-232C serial communication module with keys for programming the microcontroller FLASH memory	3	----	CC--
CAN/RS-485-01	CAN and RS-485 interface module	3	----	CA--
CAN-01	CAN interface module	3	----	CD--
PLC11	PLC module	1, 2 and 3	----	---- ⁽¹⁾
PROFIBUS DP-01	Profibus DP interface module	3		
PROFIBUS DP-05	Profibus-DP interface module	4	----	---- ⁽³⁾
DEVICENET-05	DeviceNet interface module	4	----	---- ⁽³⁾
ETHERNET IP-05	Ethernet interface module	4	----	---- ⁽³⁾
RS-232-05	RS-232 interface module	4	----	---- ⁽³⁾
RS-485-05	RS-485 interface module	4	----	---- ⁽³⁾
MMF-03	FLASH Memory Module	5	----	---- ⁽²⁾

For Anybus-CC communication modules (slot 4), PLC11 module and for the FLASH memory module, the P028 identification code will depend on the combination of these accessories, as presented in the [Table 6.2 on page 6-3](#).

Table 6.2 - Formation of the two first codes for P0028 parameter

Bits							
7	6	5	4	3	2	1	0
PLC module	FLASH Memory Module	Anybus-CC modules 01 = Active Module 10 = Passive Module		0	0	0	0
2 nd Hexadecimal Code				1 st Hexadecimal Code			

- (1) Bit 7: indicates the presence of the PLC module (0 = without PLC module, 1 = with PLC module).
- (2) Bit 6: indicates the presence of the FLASH memory module (0 = without memory module, 1 = with memory module).
- (3) Bits 5 and 4: indicate the presence of Anybus-CC modules, as follows.

Table 6.3 - Module types

Bits			
5	4	Type of Module	Name
0	1	Active	PROFIBUS DP-05, DEVICENET-05, ETHERNET IP-05
1	0	Passive	RS-232-05, RS-485-05

Bits 3, 2, 1 and 0 are fixed in 0000, and form always the code "0" in hexadecimal.

Example: For An inverter equipped with the IOA-01, ENC-02, RS-485-01, PROFIBUS DP-05 modules, and the FLASH memory module, the hexadecimal code presented in the parameters P0027 and P0028 is respectively FDC2 and CE50 ([Table 6.4 on page 6-4](#)).

Table 6.4 - Example of the two first characters of the code showed in P0028 for PROFIBUS DP-05 and FLASH memory module

7	6	5	4	3	2	1	0
0	1	0	1	0	0	0	0
5				0			

P0029 – Power Hardware Configuration

Adjustable Range:	Bit 0 to 5 = Rated Current Bit 6 and 7 = Rated Voltage Bit 8 = EMC Filter Bit 9 = Safety Relay Bit 10 = (0)24V/(1)DC Link Bit 11 = DC Special Hardware Bit 12 = Dyn.Brak. IGBT Bit 13 = Special Bit 14 and 15 = Reserved	Factory Setting:
Properties:	RO	
Access groups via HMI:	01 PARAMETER GROUPS 42 Inverter Data	

Description:

In a similar way than parameters P0027 and P0028, the parameter P0029 identifies the inverter model and the present accessories. The codification is formed by the combination of binary digits, and presented in the keypad (HMI) in hexadecimal format.

The bits that compose the code are explained in the [Table 6.5 on page 6-4](#).

Table 6.5 - Parameter P0029 code constitution

Bits															
15	14	13	12	11	10	9	8	7	6	5	4	3	2	1	0
1	1	0	With braking IGBT	0	with 24V supply	with safety relay	with RFI filter	Voltage 00 = 200...240 V 01 = 380...480 V 10 = 500...600 V 11 = 660...690 V			Current				
4th Hexadecimal Code				3rd Hexadecimal Code				2nd Hexadecimal Code				1st Hexadecimal Code			

Bits 15, 14 and 13: are fixed in 110.

Bit 12: it indicates the presence of the dynamic braking IGBT (0 = with braking IGBT, 1 = without braking IGBT).

Bit 11: indicates if the inverter is equipped with the "DC special hardware" (optional) (1 = CFW11 with DC special hardware, 0 = for the other inverter models).

Bit 10: indicates if the inverter has the DC/DC converter for receiving external 24 V electronics power supply (0 = with DC/DC converter, 1 = without DC/DC 24 V converter).

Bit 9: indicates the presence of the safety relay (0 = without safety relay, 1 = with safety relay).

Bit 8: indicates if the inverter is equipped with RFI suppressor filter (0 = without RFI filter, 1 = with RFI filter).

Bits 7 and 6: indicate the inverter power supply voltage (00 = 200...240 V, 01 = 380/480 V).

Bits 5, 4, 3, 2, 1 and 0: together with the voltage indication bits (7 and 6), they indicate the inverter rated current (ND). The [Table 6.6 on page 6-5](#) presents the combinations available for those bits.

Table 6.6 - Current codification for the parameter P0029

Frame Size	Voltage	Bits		Current	Bits						
		7	6		5	4	3	2	1	0	
A	200... 240 V	0	0	2 A*	0	0	0	0	0	0	0
				6 A*	0	0	0	0	0	0	1
				7 A*	0	0	0	0	0	1	0
				10 A	0	0	0	0	0	1	1
				7 A	0	0	0	1	0	0	0
				10 A	0	0	0	1	0	1	0
				13 A	0	0	0	1	1	0	0
				16 A	0	0	0	1	1	1	1
				24 A	0	0	1	0	0	0	0
				28 A	0	0	1	0	0	0	1
				33.5 A	0	0	1	0	1	0	0
				45 A	0	0	1	1	0	0	0
				54 A	0	0	1	1	0	1	0
				70 A	0	0	1	1	1	0	0
B	200... 240 V	0	0	86 A	0	1	0	0	0	0	0
				105 A	0	1	0	0	0	0	1
				180 A	0	1	0	0	1	0	0
				211 A	0	1	0	0	1	1	0
				142 A	0	1	0	1	0	0	0
				3.6 A	0	0	0	0	0	0	0
A	380... 480 V	0	1	5 A	0	0	0	0	0	1	
				7 A	0	0	0	0	1	0	
				10 A	0	0	0	1	0	0	
				13.5 A	0	0	0	1	0	1	
				17 A	0	0	1	0	0	0	
				24 A	0	0	0	1	1	0	
				31 A	0	0	0	1	1	1	
				38 A	0	0	0	0	1	1	
				45 A	0	0	1	0	1	0	
				58.5 A	0	0	1	0	1	1	
				70.5 A	0	0	1	1	0	0	
				88 A	0	0	1	1	0	1	
				105 A	0	1	0	0	0	0	
				142 A	0	1	0	0	0	1	
180 A	0	1	0	0	1	0					
211 A	0	1	0	0	1	1					
226 A	0	1	0	1	0	0					
E	380... 480 V	0	1	242 A	1	1	0	0	0	0	
				312 A	1	1	0	0	0	1	
				370 A	1	1	0	0	1	0	
				477 A	1	1	0	0	1	1	
				515 A	1	1	1	0	0	0	
				760 A	1	1	0	1	1	1	
				601 A	1	1	1	0	0	1	
				720 A	1	1	1	0	1	0	
				760 A	1	1	1	0	1	1	
				2.9 A	0	0	1	0	1	0	
B	500... 600 V	1	0	4.2 A	0	0	1	0	1	1	
				7 A	0	0	1	1	0	0	
				10 A	0	0	1	1	0	1	
				12 A	0	0	1	1	1	0	
				17 A	0	0	1	1	1	1	
				22 A	1	1	0	1	1	0	
				27 A	1	1	0	1	1	1	
				32 A	1	1	1	0	0	0	
C	500... 600 V	1	0	44 A	1	1	1	0	0	1	
				2.9 A	0	0	0	0	0	0	
				4.2 A	0	0	0	0	0	1	
				7 A	0	0	0	0	1	0	
				10 A	0	0	0	0	1	1	
				12 A	0	0	0	1	0	0	
D				17 A	0	0	0	1	0	1	
				22 A	0	0	0	1	1	0	
				27 A	0	0	0	1	1	1	
				32 A	0	0	1	0	0	0	
				44 A	0	0	1	0	0	1	

Frame Size	Voltage	Bits		Current	Bits					
		7	6		5	4	3	2	1	0
E	660... 690 V	1	1	53 A	1	1	0	0	0	1
				63 A	1	1	0	0	1	0
				80 A	1	1	0	0	1	1
				107 A	0	1	0	0	1	1
				125 A	0	1	0	1	0	0
150 A				0	1	0	1	0	1	
F				170 A	0	1	0	1	1	0
				216 A	0	1	0	1	1	1
				289 A	0	1	1	0	0	0
G				315 A	0	1	1	0	0	1
				365 A	0	1	1	0	1	0
				435 A	0	1	1	0	1	1
				427 A	0	1	1	1	0	0
D				2.9 A	0	0	0	0	0	0
				4.2 A	0	0	0	0	0	1
	7 A	0	0	0	0	1	0			
	8.5 A	0	0	0	0	1	1			
	11 A	0	0	0	1	0	0			
	15 A	0	0	0	1	0	1			
	20 A	0	0	0	1	1	0			
	24 A	0	0	0	1	1	1			
	30 A	0	0	1	0	0	0			
	35 A	0	0	1	0	0	1			
E	46 A	1	1	0	0	0	1			
	54 A	1	1	0	0	1	0			
	73 A	1	1	0	0	1	1			
	100 A	0	1	0	0	1	1			
	108 A	0	1	0	1	0	0			
	130 A	0	1	0	1	0	1			
F	147 A	0	1	0	1	1	0			
	195 A	0	1	0	1	1	1			
	259 A	0	1	1	0	0	0			
G	259 A	0	1	1	0	0	1			
	312 A	0	1	1	0	1	0			
	365 A	0	1	1	0	1	1			
	427 A	0	1	1	1	0	0			

* Models with single-phase/three-phase power supply.

Example: For a 10 V, 380...480 V CFW-11, with RFI suppressor filter, without safety relay and without external 24 V supply, the hexadecimal code presented in the keypad (HMI) for the parameter P0029 is C544 (refer to the [Table 6.7](#) on page 6-6).

Table 6.7 - Example of the code at P0029 for a specific inverter model

15	14	13	12	11	10	9	8	7	6	5	4	3	2	1	0
1	1	0	0	0	1	0	1	0	1	0	0	0	1	0	0
C			5				4				4				

P0295 – ND/HD VFD Rated Current

**Adjustable
Range:**

- 0 = 3.6 A / 3.6 A
- 1 = 5 A / 5 A
- 2 = 6 A / 5 A
- 3 = 7 A / 5.5 A
- 4 = 7 A / 7 A
- 5 = 10 A / 8 A
- 6 = 10 A / 10 A
- 7 = 13 A / 11 A
- 8 = 13.5 A / 11 A
- 9 = 16 A / 13 A
- 10 = 17 A / 13.5 A
- 11 = 24 A / 19 A
- 12 = 24 A / 20 A
- 13 = 28 A / 24 A
- 14 = 31 A / 25 A
- 15 = 33.5 A / 28 A
- 16 = 38 A / 33 A
- 17 = 45 A / 36 A
- 18 = 45 A / 38 A
- 19 = 54 A / 45 A
- 20 = 58.5 A / 47 A
- 21 = 70 A / 56 A
- 22 = 70.5 A / 61 A
- 23 = 86 A / 70 A
- 24 = 88 A / 73 A
- 25 = 105 A / 86 A
- 26 = 427 A / 340 A
- 27 = 470 A / 380 A
- 28 = 811 A / 646 A
- 29 = 893 A / 722 A
- 30 = 1217 A / 969 A
- 31 = 1340 A / 1083 A
- 32 = 1622 A / 1292 A
- 33 = 1786 A / 1444 A
- 34 = 2028 A / 1615 A
- 35 = 2232 A / 1805 A
- 36 = 2 A / 2 A
- 37 = 640 A / 515 A
- 38 = 1216 A / 979 A
- 39 = 1824 A / 1468 A
- 40 = 2432 A / 1957 A
- 41 = 3040 A / 2446 A
- 42 = 600 A / 515 A
- 43 = 1140 A / 979 A
- 44 = 1710 A / 1468 A
- 45 = 2280 A / 1957 A
- 46 = 2850 A / 2446 A
- 47 = 105 A / 88 A
- 48 = 142 A / 115 A
- 49 = 180 A / 142 A
- 50 = 211 A / 180 A
- 51 = 242 A / 211 A
- 52 = 312 A / 242 A
- 53 = 370 A / 312 A
- 54 = 477 A / 370 A
- 55 = 515 A / 477 A
- 56 = 601 A / 515 A
- 57 = 720 A / 560 A
- 58 = 2.9 A / 2.7 A
- 59 = 4.2 A / 3.8 A
- 60 = 7 A / 6.5 A
- 61 = 8.5 A / 7 A
- 62 = 10 A / 9 A

**Factory
Setting:**

63 = 11 A / 9 A
 64 = 12 A / 10 A
 65 = 15 A / 13 A
 66 = 17 A / 17 A
 67 = 20 A / 17 A
 68 = 22 A / 19 A
 69 = 24 A / 21 A
 70 = 27 A / 22 A
 71 = 30 A / 24 A
 72 = 32 A / 27 A
 73 = 35 A / 30 A
 74 = 44 A / 36 A
 75 = 46 A / 39 A
 76 = 53 A / 44 A
 77 = 54 A / 46 A
 78 = 63 A / 53 A
 79 = 73 A / 61 A
 80 = 80 A / 66 A
 81 = 100 A / 85 A
 82 = 107 A / 90 A
 83 = 108 A / 95 A
 84 = 125 A / 107 A
 85 = 130 A / 108 A
 86 = 150 A / 122 A
 87 = 147 A / 127 A
 88 = 170 A / 150 A
 89 = 195 A / 165 A
 90 = 216 A / 180 A
 91 = 289 A / 240 A
 92 = 259 A / 225 A
 93 = 315 A / 289 A
 94 = 312 A / 259 A
 95 = 365 A / 315 A
 96 = 365 A / 312 A
 97 = 435 A / 357 A
 98 = 428 A / 355 A
 99 = 472 A / 388 A
 100 = 700 A / 515 A
 101 = 1330 A / 979 A
 102 = 1995 A / 1468 A
 103 = 2660 A / 1957 A
 104 = 3325 A / 2446 A
 105 = 760 A / 600 A
 106 = 760 A / 560 A
 107 = 226 A / 180 A

Properties: RO

Access groups via HMI: 01 PARAMETER GROUPS

42 Inverter Data

Description:

This parameter presents the inverter rated current for the normal overload regimen (ND) and for the heavy overload regimen (HD). The inverter operation mode, if it is ND or HD, is defined by the content of P0298.

P0296 – Line Rated Voltage

Adjustable Range:	0 = 200... 240 V 1 = 380 V 2 = 400 / 415 V 3 = 440 / 460 V 4 = 480 V 5 = 500 / 525 V 6 = 550 / 575 V 7 = 600 V 8 = 660 / 690 V	Factory Setting:	According to the inverter model
Properties:	CFG		
Access groups via HMI:	01 PARAMETER GROUPS 42 Inverter Data		

Description:

Setting according to the inverter power supply voltage.

The adjustable range depends on the inverter model, according to the [Table 6.8 on page 6-9](#), which also presents the factory default value.

 **NOTE!** When adjusted via the keypad (HMI), this parameter may change automatically the following parameters: P0151, P0153, P0185, P0190, P0321, P0322, P0323 and P0400.

 **NOTE!** When changed from P0296 = 5, 6 or 7 to P0296 = 8 or vice-versa, the following parameters could be changed automatically: P0029, P0135, P0156, P0157, P0158, P0290, P0295, P0297, P0401 and P0410.

Table 6.8 - P0296 setting according to the CFW-11 inverter model

Inverter Model	Adjustable Range	Factory Setting
200-240 V	0 = 200...240 V	0
380-480 V	1 = 380 V	3
	2 = 400 / 415 V	
	3 = 440 / 460 V	
	4 = 480 V	
500-600 V	5 = 500 / 525 V	6
	6 = 550 / 575 V	
	7 = 600 V	
660-690 V	8 = 660 / 690 V	8

P0297 – Switching Frequency

Adjustable Range:	0 = 1.25 kHz 1 = 2.5 kHz 2 = 5.0 kHz 3 = 10.0 kHz 4 = 2.0 kHz	Factory Setting: According to inverter model
Properties:	CFG	
Access groups via HMI:	<div style="border: 1px solid black; padding: 2px; display: inline-block;">01 PARAMETER GROUPS</div> <div style="border: 1px solid black; padding: 2px; display: inline-block; margin-left: 20px;">42 Inverter Data</div>	

Description:

6

Refer to the allowed current for switching frequencies different from the default, in the tables available in chapter 8 - Technical Specifications, of the CFW-11 user's manual.

The inverter switching frequency can be adjusted according to the needs of the application. Higher switching frequencies imply in lower motor acoustic noise, however, the selection of the switching frequency results in a compromise between the motor acoustic noises, the losses in the inverter IGBTs and the maximum allowed currents.

The reduction of the switching frequency reduces effects related to motor instability, which occur in specific application conditions. It also reduces the earth leakage current, being able to avoid the actuation of the faults F074 (Ground Fault) or F070 (Output Overcurrent/Short Circuit).

Note: The option 0 (1.25 kHz) is only allowed for the V/f or VVW control (P0202 = 0, 1, 2 or 5).



NOTE!

In case the selected option is not permitted, the HMI will display the message: "P0297 and P0296 Incompatible", and the inverter status will change to: "Config", and P0006 = Configuration. The incompatibilities between P0296 and P0297 are shown in option 37 of [Section 5.7 INCOMPATIBILITY BETWEEN PARAMETERS](#) on page 5-12 of this manual.

P0298 – Application

Adjustable Range:	0 = Normal Duty (ND) 1 = Heavy Duty (HD)	Factory Setting: 0
Properties:	CFG	
Access groups via HMI:	<div style="border: 1px solid black; padding: 2px; display: inline-block;">01 PARAMETER GROUPS</div> <div style="border: 1px solid black; padding: 2px; display: inline-block; margin-left: 20px;">42 Inverter Data</div>	

Description:

Set the content of this parameter according to the application.

The **Normal Duty Regimen (ND)** defines the maximum current for continuous operation (I_{nom-ND}) and an **overload of 110 % during 1 minute**. It must be used for driving motors that are not subject in that application to high torques in relation to their rated torque, when operating in permanent regimen, during start, acceleration or deceleration.

The **Heavy Duty Regimen (HD)** defines the maximum current for continuous operation (I_{nom-HD}) and an **overload of 150 % during 1 minute**. It must be used for driving motors that are subject in that application to high overload torques in relation to their rated torque, when operating in constant speed, during start, acceleration or deceleration.

The I_{nom-ND} and I_{nom-HD} are presented in P0295. Refer to the CFW-11 user's manual chapter 8 - Technical Specifications, for more details regarding these operation regimens.

7 STARTING-UP AND SETTINGS

In order to start-up in the several types of controls, beginning from the factory settings, consult the following sections:

- [Section 10.3 VVW CONTROL MODE START-UP](#) on page 10-5.
- [Section 11.9 START-UP IN THE VECTOR MODES SENSORLESS AND WITH ENCODER](#) on page 11-32.

In order to use previously loaded parameters, refer to the [Section 7.1 BACKUP PARAMETERS \[06\]](#) on page 7-1, described next.

7.1 BACKUP PARAMETERS [06]

The CFW-11 BACKUP functions allow saving the content of the current inverter parameters in a specific memory, or vice-versa (overwrite the contents of the current parameters with the memory contents). Besides, there is a function exclusive for software update, by means of the FLASH Memory Module.

P0204 – Load/Save Parameters

7

Adjustable Range:	0 = Not Used 1 = Not Used 2 = Reset P0045 3 = Reset P0043 4 = Reset P0044 5 = Load 60 Hz 6 = Load 50 Hz 7 = Load User 1 8 = Load User 2 9 = Load User 3 10 = Save User 1 11 = Save User 2 12 = Save User 3	Factory Setting: 0
Properties:	CFG	
Access groups via HMI:	06 BACKUP PARAMETERS	

Description:

It makes it possible to save the actual inverter parameters in an area of the control module EEPROM memory or the other way around, to load the contents of that area into the parameters. It also allows resetting the Time Enabled (P0043), kWh (P0044) and Fan Enabled Time (P0045) counters. The [Table 7.1 on page 7-2](#) describes the actions performed by each option.

Table 7.1 - Parameter P0204 options

P0204	Action
0, 1	Not Used: no action
2	Reset P0045: resets the enabled fan hour counter
3	Reset P0043: resets the enabled hours counter
4	Reset P0044: resets the kWh counter
5	Load 60 Hz: loads the 60 Hz factory settings into the inverter parameters
6	Load 50 Hz: loads the 50 Hz factory settings into the inverter parameters
7	Load User 1: loads the User 1 parameters into the current inverter parameters
8	Load User 2: loads the User 2 parameters into the current inverter parameters
9	Load User 3: loads the User 3 parameters into the current inverter parameters
10	Save User 1: saves the current inverter parameters into the User 1 parameter memory
11	Save User 2: saves the current inverter parameters into the User 2 parameter memory
12	Save User 3: saves the current inverter parameters into the User 3 parameter memory

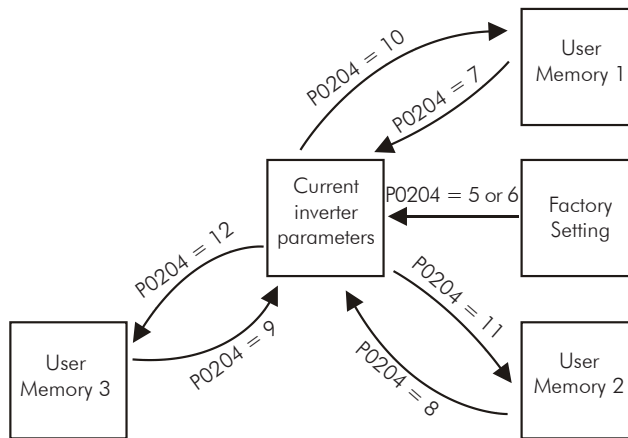

Figure 7.1 - Parameter transfer

In order to load parameters from User 1, User 2 and/or User 3 to the CFW-11 operation area (P0204 = 7, 8 or 9), it is necessary that these areas had been saved previously.

The operation of loading one of those memories can also be performed via digital inputs (DIx). Refer to the [Item 13.1.3 Digital Inputs \[40\]](#) on page 13-12, for more details regarding this programming (P0204 = 10, 11 or 12).



NOTE!

When P0204 = 5 or 6, the parameters P0201 (Language), P0295 (Rated Current), P0296 (Line Rated Voltage), P0297 (Switching Frequency), P0308 (Serial Address), P0352 (Fan Control Configuration) and P0359 (Motor Current Stab.), will not be change by the factory settings.

P0317 - Oriented Start-up

Adjustable Range:	0 = No 1 = Yes	Factory Setting:	0
Properties:	CFG		
Access groups via HMI:	02 ORIENTED START-UP		

Description:

When this parameter is changed to "1", the Oriented Start-up routine starts. The CFW11 goes into the "CONF" state, which is indicated on the HMI. Within the Oriented Start-up, the user has access to important configuration parameters of the CFW11 and of the motor for the control type to be used in the application. For further information on the use of this parameter, refer to the following sections:

[Section 10.3 VVW CONTROL MODE START-UP on page 10-5.](#)

[Section 11.9 START-UP IN THE VECTOR MODES SENSORLESS AND WITH ENCODER on page 11-32.](#)

7

P0318 – Copy Function MemCard

Adjustable Range:	0 = Off 1 = VFD → MemCard 2 = MemCard → VFD	Factory Setting:	0
Properties:	CFG		
Access groups via HMI:	06 BACKUP PARAMETERS		

Description:

This function allows saving the contents of the inverter writing parameters in the FLASH Memory Module (MMF), or vice-versa, and can be used to transfer the contents of the parameters from one inverter to another.

Table 7.2 - Parameter P0318 options

P0318	Action
0	Inactive: no action
1	Inverter → MemCard: transfers the inverter current parameters contents to the MMF
2	MemCard → Inverter: transfers the contents of the parameters stored in the MMF to the inverter control board After the transfer has been finished, an inverter reset occurs. The content of P0318 returns to 0

After storing the parameters of one inverter in a FLASH memory module, it is possible to pass them to another inverter with this function. However, if the inverters are from different models or with incompatible software versions, the keypad (HMI) will exhibit the message "Flash Mem. Module with invalid parameters" and will not allow the copy.

**NOTE!**

Valid for P0318 = 1.

During the inverter operation the modified parameters are saved in the FLASH memory module, regardless of a user command. This assures that the MMF will always have an updated copy of the inverter parameters.



NOTE!

Valid for P0318 = 1.
 When the inverter is powered and the memory module is present, the current parameter contents are compared with the contents of the parameters saved in the MMF and, in case they are different, the keypad (HMI) will exhibit the message "Flash Mem.Module with different parameters", after 3 seconds the message is replaced by the parameter P0318 menu. The user has the option to overwrite the contents of the memory module (choosing P0318 = 1), or overwrite the inverter parameters (choosing P0318 = 2), or even ignore the message by programming P0318 = 0.



NOTE!

When using the network communication board, the SoftPLC function or the PLC11 board, it is recommended to set the parameter P0318 = 0.x

P0319 – Copy Function HMI

7

Adjustable Range:	0 = Off 1 = VFD → HMI 2 = HMI → VFD	Factory Setting: 0
Properties:	CFG	
Access groups via HMI:	06 BACKUP PARAMETERS	

Description:

The Copy Function HMI is similar to the previous, and it is also used to transfer the contents of the parameters from one inverter to another (others). The inverters have the same software version. If the versions are different, by programming P0319 = 2, the HMI will show the message "Incompatible software version" during 3 seconds. After removing the message from the HMI, the content of P0319 returns to zero.

Table 7.3 - Parameter P0319 options

P0319	Action
0	Inactive: no action
1	Inverter → HMI: transfers the inverter current parameters and the user memories 1, 2 and 3 contents to the keypad (HMI) nonvolatile memory (EEPROM). The inverter current parameters remain unchanged ⁽¹⁾
2	HMI → Inverter: transfers the content of the keypad (HMI) nonvolatile memory (EEPROM) to the current inverter parameters and to the user memories 1, 2 and 3. After the transfer has been finished, an inverter reset occurs ⁽¹⁾

(1) The content of P0319 returns to zero.

In order to copy parameters from one inverter to another, one must proceed in the following manner:

1. Connect the keypad (HMI) to the inverter from which one wants to copy the parameters (Inverter A).
2. Set P0319 = 1 (VFD → HMI) to transfer the parameters from the Inverter A to the keypad (HMI).
3. Press the right "soft key" "Save". P0319 returns automatically to 0 (inactive) as soon as the transfer is finished.
4. Disconnect the keypad (HMI) from the inverter.
5. Connect the same keypad (HMI) to the invert to which one wants to transfer the parameters (Inverter B).
6. Set P0319 = 2 (HMI → VFD) to transfer the contents of the keypad (HMI) nonvolatile memory (EEPROM with the Inverter A parameters) to the Inverter B.
7. Press the right "soft key" "Save". When P0319 returns to 0 the transfer of the parameters has been finished.

From that moment on the Inverters A and B will have the parameters with the same contents.

Notes:

- ☑ In case that inverters A and B are not from the same model, verify the values of P0296 (Line Rated Voltage) and P0297 (Switching Frequency) at the Inverter B.
 - ☑ If inverters A and B drive different motors, verify the Inverter B motor parameters.
8. In order to copy the contents of the Inverter A parameters to other inverters, repeat the same procedures 5 to 7 described previously.

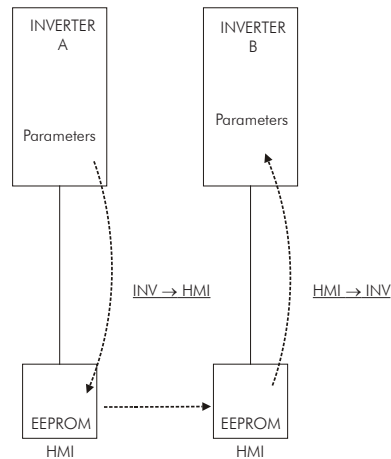

Figure 7.2 - Parameter copy from "Inverter A" to the "Inverter B"



NOTE!

As long as the keypad (HMI) is performing the reading or the writing procedure, it will not be possible to operate it.

8 AVAILABLE CONTROL TYPES

8.1 CONTROL TYPES

The inverter feeds the motor with variable voltage, current and frequency, by means of whose the control of the motor speed is obtained. The values applied to the motor follow a control strategy, which depends on the selected type of control and on the inverter parameter settings.

Choose the control type in function of the static and dynamic, torque and speed requirements of the driven load.

Control modes and their main characteristics:

- V/f:** scalar control; it is the simplest control mode, by imposed voltage/frequency; with an open loop speed regulation or with slip compensation (programmable); it allows multimotor operation.
- VVW:** Voltage Vector WEG; it allows a static speed control more accurate than the V/f mode; it adjusts itself automatically to the line variations, and also to the load variations, however it does not present fast dynamic response.
- Sensorless Vector:** it is a field oriented control; without motor speed sensor; able to drive any standard motor; speed control range of 1:100; speed control static precision of 0.5 % of the rated speed; high control dynamics.
- Vector with Encoder:** it is a field oriented control; it needs motor encoder and inverter encoder interface module (ENC1 or ENC2); speed control down to 0 rpm; speed control static precision of 0.01 % of the rated speed; high static and dynamic performance of the speed and torque control.
- Vector with Encoder for PMSM motor:** It requires an incremental encoder at the motor and the encoder interface module (ENC1, ENC2 or PLC11) at the inverter.
- Sensorless Vector for PMSM motor:** Without speed sensor at the motor; Speed control range 1:100.

All these control modes are described in details in the [Chapter 9 SCALAR CONTROL \(V/F\) on page 9-1](#), [Chapter 10 VVW CONTROL on page 10-1](#), [Chapter 11 VECTOR CONTROL on page 11-1](#), and [Chapter 21 PM VECTOR CONTROL on page 21-1](#), the related parameters and orientations regarding the use of each of these modes.

9 SCALAR CONTROL (V/F)

It consists of a simple control based on a curve that links output voltage and frequency. The inverter operates as a voltage source, generating frequency and voltage values according to that curve. It is possible to adjust this curve to standard 50 Hz or 60 Hz motors or to special ones through the adjustable V/f curve. Refer to the block diagram at the [Figure 9.1 on page 9-1](#).

The advantage of the V/f control is that due to its simplicity just a few settings are necessary. The start-up is fast and simple, and the factory settings require generally few or no modifications.

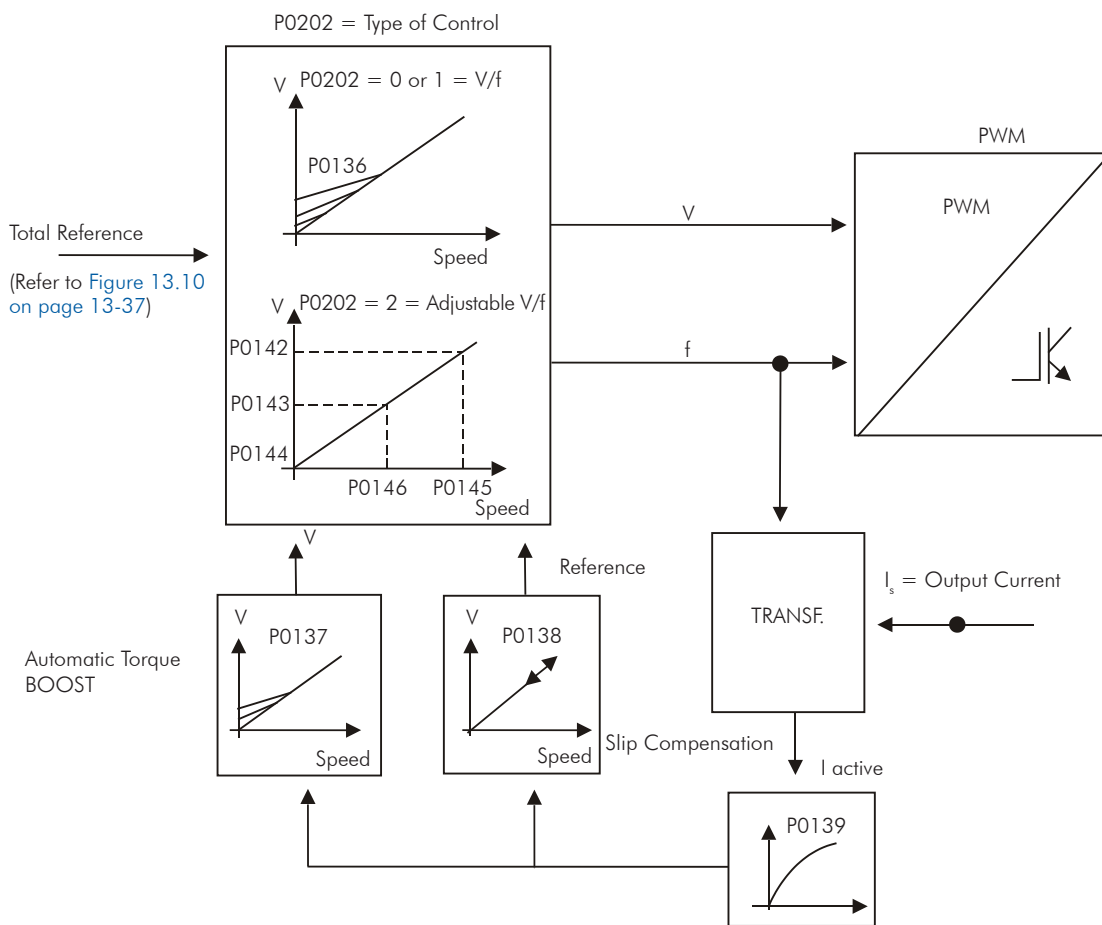

Figure 9.1 - V/f control block diagram

The V/f or scalar control is recommended for the following cases:

- Operation of several motors with the same inverter (multimotor operation).
- The motor rated current is less than 1/3 of the inverter rated current.
- The inverter is, for test purposes, enabled without motor or with a small motor and no load.

The scalar control can also be used in applications that do neither require fast dynamic response, nor accuracy in the speed regulation, and also do not require high starting torque (the speed error is a function of the motor slip, and by programming the parameter P0138 – Slip Compensation – it is possible to get a accuracy of approximately 1 % at the rated speed with the load variation).

9.1 V/F CONTROL [23]

P0136 – Manual Torque Boost

Adjustable Range:	0 to 9	Factory Setting:	According to inverter model
Properties:	V/f		
Access groups via HMI:	01 PARAMETER GROUPS 23 V/f Control		

Description:

It acts at low speeds, increasing the inverter output voltage in order to compensate the voltage drop across the motor stator resistance, with the purpose of keeping the torque constant. The optimum setting is the lowest value of P0136 that allows a satisfactory starting of the motor. Values higher than the necessary will increase the motor current at low speeds, being able to lead the inverter to a fault (F048, F051, F071, F072, F078 or F183) or alarm (A046, A047, A050 or A110) condition.

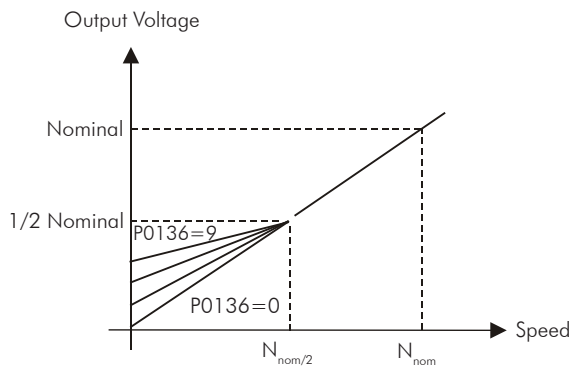

Figure 9.2 - Effect of P0136 on the V/f curve (P0202=0 or 1)



NOTE!

For large frames than frame C, the standard value is 0. For others, the standard value is 1.

P0137 – Automatic Torque Boost

Adjustable Range:	0.00 to 1.00	Factory Setting:	0.00
Properties:	V/f		
Access groups via HMI:	01 PARAMETER GROUPS 23 V/f Control		

Description:

The Automatic Torque Boost compensates the voltage drop on the stator resistance in function of the motor active current. The criteria for adjusting P0137 are the same as for the parameter P0136.

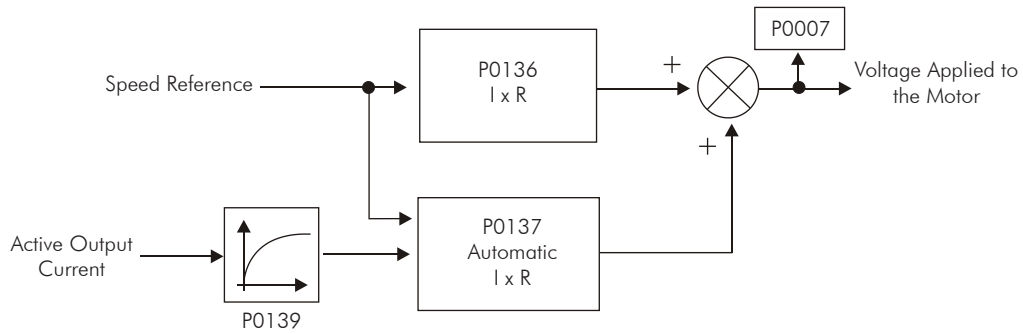

Figure 9.3 - Torque Boost block diagram

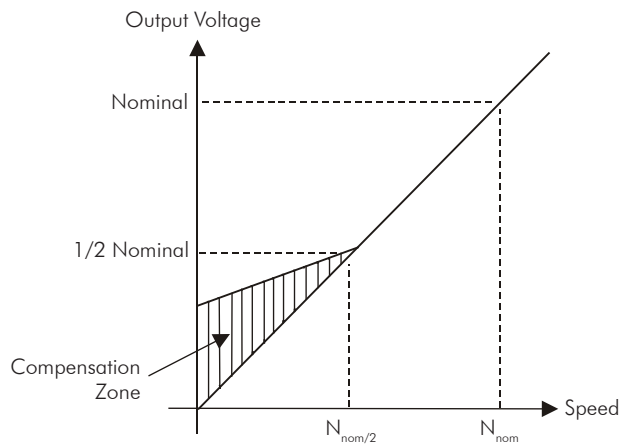

Figure 9.4 - Effect of P0137 on the V/f curve (P0202 = 0...2)

P0138 – Slip Compensation

Adjustable Range:	-10.0 to +10.0 %	Factory Setting:	0.0 %
Properties:	V/f		
Access groups via HMI:	01 PARAMETER GROUPS		
	23 V/f Control		

Description:

The parameter P0138 is used in the motor slip compensation function, when adjusted to positive values. In this case it compensates the drop in the speed due to the application of load to the motor shaft. It increases the output frequency in function of the increase in the motor active current.

The setting of P0138 allows regulating the slip compensation precisely. Once P0138 is adjusted the inverter will keep the speed constant even with load variations by adjusting the voltage and frequency automatically.

Negative values are used in special applications where one wants to reduce the output speed in function of the increase in the motor current.

E.g.: Load distribution in motors operated in parallel.

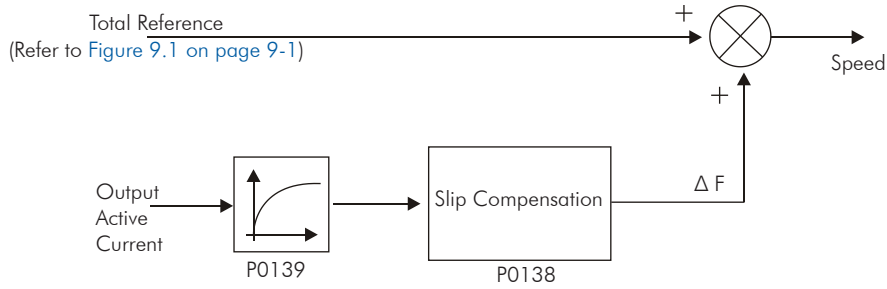

Figure 9.5 - Slip compensation block diagram

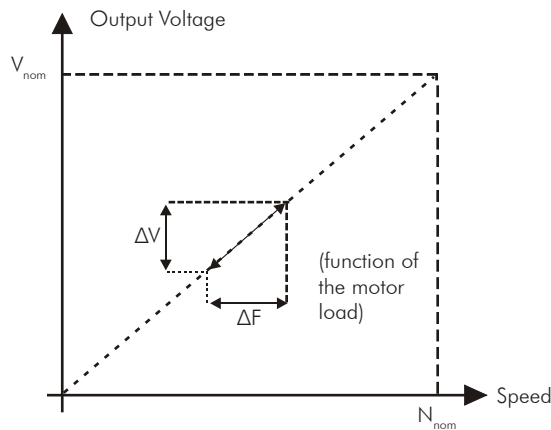

Figure 9.6 - V/f curve with slip compensation



For the adjustment of the parameter P0138 to compensate the motor slip:

- 1) Run the motor with no load at approximately half the working speed.
- 2) Measure the motor or equipment speed with a tachometer.
- 3) Apply rated load to the equipment.
- 4) Increase the content of P0138 until the speed reaches the value measured before with no load.

P0139 – Output Current Filter (Active)

Adjustable Range:	0.0 to 16.0 s	Factory Setting:	0.2 s
Properties:	V/f and VVV		
Access groups via HMI:	<div style="border: 1px solid black; padding: 2px;">01 PARAMETER GROUPS</div> <div style="border: 1px solid black; padding: 2px; margin-left: 20px;">23 V/f Control</div>		

Description:

It sets the active current filter time constant.

It is used in the Automatic Torque Boost and Slip Compensation functions. Refer to the [Figure 9.3 on page 9-3](#).

It sets the response time of the Slip Compensation and of the Automatic Torque Boost. Refer to the [Figure 9.3 on page 9-3](#) and [Figure 9.5 on page 9-4](#).

P0140 – Dwell Time at Start

Adjustable Range:	0.0 to 10.0 s	Factory Setting:	0.0 s
-------------------	---------------	------------------	-------

P0141 – Dwell Speed at Start

Adjustable Range:	0 to 300 rpm	Factory Setting:	90 rpm
Properties:	V/f and VVW		
Access groups via HMI:	<div style="border: 1px solid black; padding: 2px; display: inline-block;">01 PARAMETER GROUPS</div> <div style="border: 1px solid black; padding: 2px; display: inline-block; margin-left: 20px;">23 V/f Control</div>		

Description:

P0140 sets the time during which the speed is kept constant during the acceleration. Refer to the [Figure 9.7 on page 9-5](#). P0141 sets the speed step during the acceleration. Refer to the [Figure 9.7 on page 9-5](#). By means of these parameters it is possible to introduce a speed step during the acceleration, helping the starting of high torque loads.

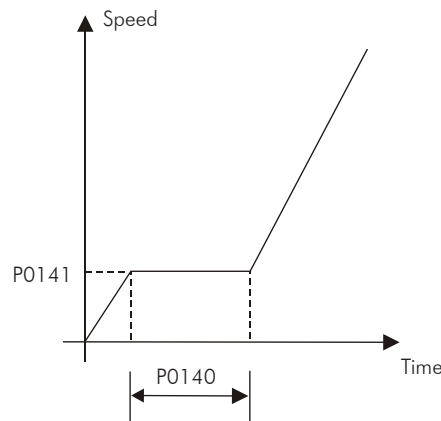

Figure 9.7 - Acceleration speed profile as a function of P0140 and P0141



NOTE!

The accommodation time will be considered null when the Flying Start function is active (P0320 = 1 or 2).

P0202 – Type of Control

Adjustable Range:	0=V/f 60 Hz 1=V/f 50 Hz 2=V/f Adjustable 3=Sensorless 4=Encoder 5=VVW (Voltage Vector WEG) 6=Encoder PM 7=Sensorless PM	Factory Setting:	0
Properties:	CFG		
Access groups via HMI:	<div style="border: 1px solid black; padding: 2px; display: inline-block;">01 PARAMETER GROUPS</div> <div style="border: 1px solid black; padding: 2px; display: inline-block; margin-left: 20px;">23 V/f Control</div>		

Description:

In order to get an overview of the control types, as well as orientation to choose the most suitable type for the application, refer to the [Chapter 8 AVAILABLE CONTROL TYPES](#) on page 8-1.

For the V/f mode, select P0202 = 0, 1 or 2:



Parameter P0202 setting for the V/f mode:

- P0202 = 0 for motors with rated frequency = 60 Hz.
- P0202 = 1 for motors with rated frequency = 50 Hz.

Notes:

- The correct setting of P0400 assures the application of the correct V/f ratio at the output, in case of 50 Hz or 60 Hz motors with voltage different from the inverter input voltage.
- P0202 = 2: for special motors with rated frequency different from 50 Hz or 60 Hz, or for the adjustment of special V/f curve profiles. Example: the approximation of a quadratic V/f curve for energy saving in variable torque loads like centrifuge pumps and fans.

9.2 ADJUSTABLE V/F CURVE [24]

9

P0142 – Maximum Output Voltage

P0143 – Intermediate Output Voltage

P0144 – 3Hz Output Voltage

Adjustable Range:	0.0 to 100.0 %	Factory Setting:	P0142 = 100.0 % P0143 = 50.0 % P0144 = 8.0 %
Properties:	CFG and Adj		
Access groups via HMI:	<div style="border: 1px solid black; padding: 2px;">01 PARAMETER GROUPS</div> <div style="border: 1px solid black; padding: 2px; margin-left: 20px;">24 Adjust. V/f Curve</div>		

Description:

The full scale of parameters P0142 to P0144 is the line voltage of the grid. However, if the output voltage compensation function is enabled (P0341 = 1), the full scale becomes the value set in P0400 for operation up to the synchronous speed.

P0145 – Field Weakening Speed

P0146 – Intermediate Speed

Adjustable Range:	0 to 18000 rpm	Factory Setting:	P0145 = 1800 rpm P0146 = 900 rpm
Properties:	Adj and CFG		
Access groups via HMI:	<div style="border: 1px solid black; padding: 2px; display: inline-block;">01 PARAMETER GROUPS</div> <div style="border: 1px solid black; padding: 2px; display: inline-block; margin-left: 20px;">24 Adjust. V/f Curve</div>		

Description:

This function allows the adjustment of the curve that links output voltage and frequency by means of parameters, as presented by the [Figure 9.8 on page 9-7](#), in V/f mode.

It is necessary when the used motor has a rated frequency different from 50 Hz or 60 Hz, or when a quadratic V/f curve, for energy saving in the operation of centrifuge pumps and fans, is desired, or even in special applications, such as, for instance, when a transformer is used at the inverter output, between it and the motor.

The function is activated with P0202 = 2 (Adjustable V/f).

The factory setting of P0144 (8.0 %) is adequate for standard motors with rated frequency of 60 Hz. When using a motor with rated frequency (adjusted in P0403) different from 60 Hz, the default value for P0144 may become inadequate, being able to cause difficulties in the motor starting. A good approximation for the setting of P0144 is given by the formula:

$$P0144 = \frac{3}{P0403} \times P0142$$

If it is necessary to increase the starting torque, increase gradually the value of P0144.

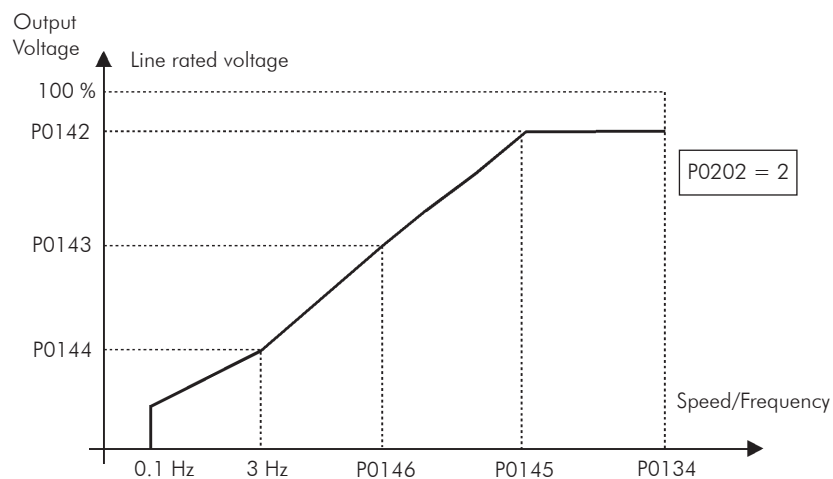

Figure 9.8 - V/f curve in function of P0142 to P0146

9.3 V/F CURRENT LIMITATION [26]

P0135 – Maximum Output Current

Adjustable Range:	0.2 to $2xI_{nom-HD}$	Factory Setting:	$1.5xI_{nom-HD}$
Properties:	V/f and VVV		
Access groups via HMI:	<div style="border: 1px solid black; padding: 2px; display: inline-block;">01 PARAMETER GROUPS</div> <div style="border: 1px solid black; padding: 2px; display: inline-block; margin-left: 20px;">26 V/f Current Limit</div>		

P0344 – Current Limitation Configuration

Adjustable Range:	0 = Hold -FL ON 1 = Decel. -FL ON 2 = Hold -FL OFF 3 = Decel. -FL OFF	Factory Setting:	3
Properties:	V/f, CFG and VVV		
Access groups via HMI:	<div style="border: 1px solid black; padding: 2px; display: inline-block;">01 PARAMETER GROUPS</div> <div style="border: 1px solid black; padding: 2px; display: inline-block; margin-left: 20px;">26 V/f Current Limit</div>		

9

Description:

It is the current limitation for the V/f control with actuation mode defined by P0344 (refer to the [Table 9.1 on page 9-8](#)) and the current limit defined by P0135.

Table 9.1 - Current limitation configuration

P0344	Function	Description
0 = Hold - FL ON	Current limitation of the "Ramp Hold" type Active fast current limitation	Current limitation according to the Figure 9.9 on page 9-9 (a) Fast current limitation at the value $1.9 \times I_{nomHD}$ active
1 = Decel. - FL ON	Current limitation of the "Ramp Deceleration" type Active fast current limitation	Current limitation according to the Figure 9.9 on page 9-9 (b) Fast current limitation at the value $1.9 \times I_{nomHD}$ active
2 = Hold - FL OFF	Current limitation of the "Ramp Hold" type Inactive fast current limitation	Current limitation according to the Figure 9.9 on page 9-9 (a)
3 = Decel.- FL OFF	Current limitation of the "Ramp Deceleration" type Inactive fast current limitation	Current limitation according to the Figure 9.9 on page 9-9 (b)

Current limitation of the "Ramp Hold" type:

- It avoids the stalling of the motor during a torque overload at the acceleration or at the deceleration.
- Working: if the motor current exceeds the value adjusted in P0135 during the acceleration or the deceleration, the speed will no longer be increased (acceleration) or decreased (deceleration). When the motor current reaches a value below P0135 the motor will again accelerate or decelerate. Refer to the [Figure 9.9 on page 9-9 \(a\)](#).
- It acts faster than the "Ramp Deceleration" mode.
- It acts in the motorization and braking modes.

Current limitation of the "Ramp Deceleration" type:

- ☑ It avoids the stalling of the motor during a torque overload at the acceleration or at constant speed.
- ☑ Working: if the motor current exceeds the value adjusted in P0135, the input of the speed ramp is set to zero forcing a deceleration. When the motor current reaches a value below P0135 the motor will accelerate again. Refer to the [Figure 9.9 on page 9-9 \(b\)](#).

Fast current limitation:

- ☑ It reduces the inverter output voltage instantaneously when the motor current reaches the value of $1.9 \times I_{nomHD}$.

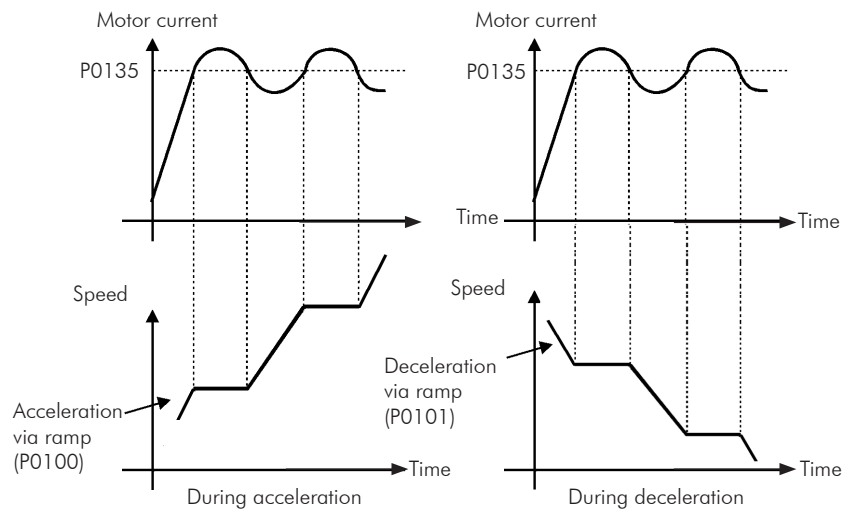

(a) "Ramp Hold"

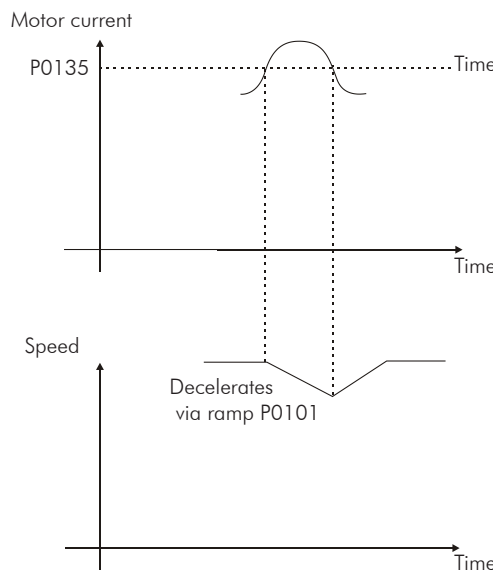

(b) "Ramp Deceleration"

Figure 9.9 - (a) and (b) - Current limitation via P0135 working modes

9.4 V/F DC VOLTAGE LIMITATION [27]

There are two functions in the inverter for limiting the DC link voltage during the motor braking. They act limiting the braking torque and power, avoiding therefore the tripping of the inverter by overvoltage (F022).

The overvoltage on the DC link is more common when a load with high inertia is driven or when a short deceleration time is programmed.



NOTE!

When using the dynamic braking the function "Ramp Hold" or "Ramp Acceleration" must be disabled. Refer to the P0151 description.

In the V/f mode, there are two types of function to limit the DC link voltage:

1 – "Ramp Hold":

It is effective only during the deceleration.

Working: When the DC link voltage reaches the level adjusted in P0151, a command is sent to the "ramp" block, which inhibits the motor speed variation ("ramp hold"). Refer to the [Figure 9.10 on page 9-10](#) and [Figure 9.11 on page 9-11](#).

With this function an optimized deceleration time (minimum possible) for the driven load is obtained.

The use is recommended for loads running with high inertia moment referenced to the motor shaft, or loads with medium inertia, which require short deceleration ramps.

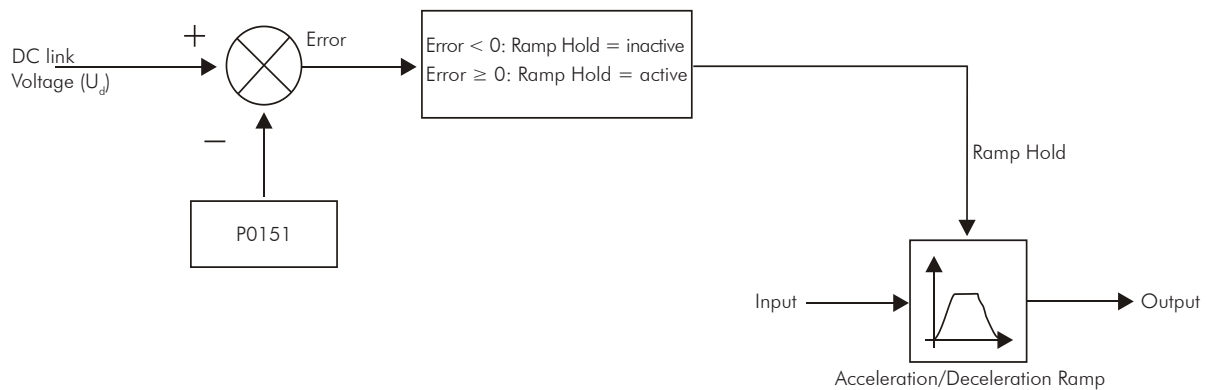

Figure 9.10 - Limitation of the DC link voltage using Ramp Hold function block diagram

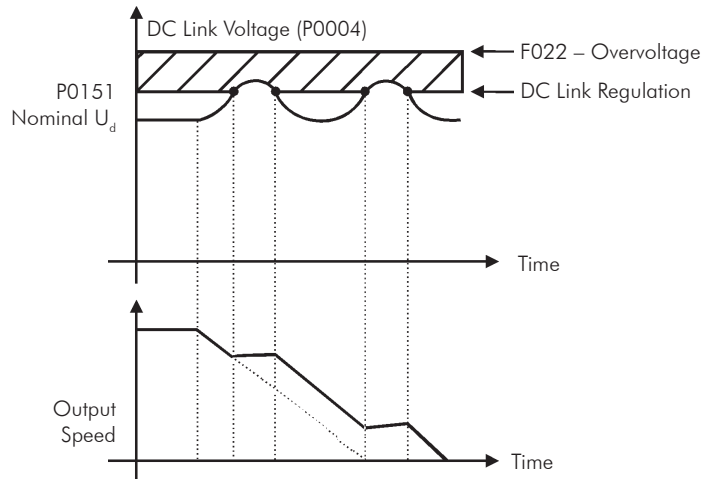

Figure 9.11 - Example of the DC link voltage limitation working with the Ramp Hold function

2 - Ramp Acceleration:

It is effective in any situation, regardless of the motor speed condition, accelerating, decelerating or at constant speed.

Working: the DC link voltage is compared with the value adjusted in P0151, the difference between these signals is multiplied by the proportional gain (P0152) and the result is added to the ramp output. Refer to the [Figure 9.12 on page 9-11](#) and [Figure 9.13 on page 9-12](#).

In a similar manner as the Ramp Hold, with this function an optimized deceleration time (minimum possible) for the driven load is also obtained.

The use is recommended for loads that require braking torques in constant speed situation. Example: driving of loads with eccentric shafts such as the existent in pumpjacks.

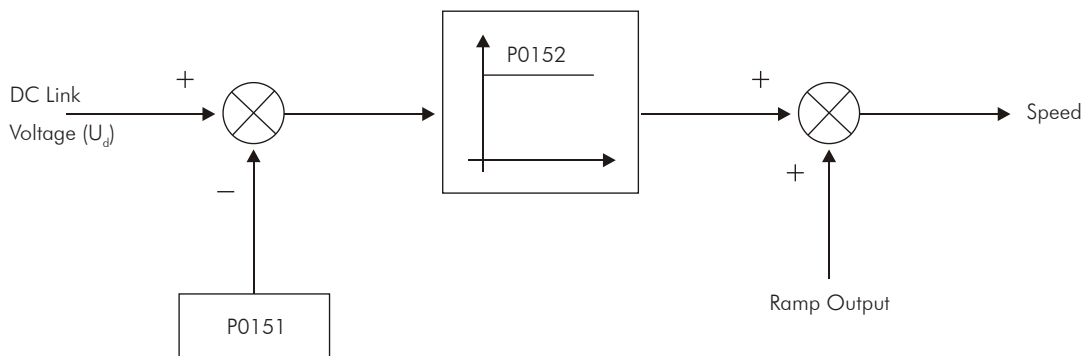

Figure 9.12 - Limitation of the DC link voltage using Ramp Hold function block diagram

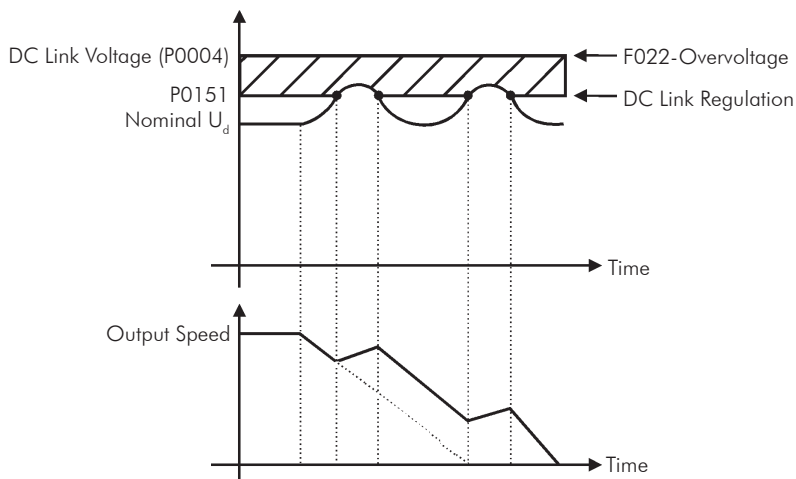

Figure 9.13 - Example of the DC link voltage limitation working with the Ramp Acceleration function

P0150 – DC Regulator Type (V/f)

Adjustable Range:	0 = Ramp Hold 1 = Ramp Acceleration	Factory Setting:	0
Properties:	V/f, CFG and VVV		
Access groups via HMI:	<input type="checkbox"/> 01 PARAMETER GROUPS <input type="checkbox"/> 27 V/f DC Volt. Limit.		

Description:

It selects the DC link voltage limitation function type in the V/f mode.

P0151 – DC Link Voltage Regulation Acting Level (V/f)

Adjustable Range:	339 to 400 V (P0296 = 0) 585 to 800 V (P0296 = 1) 585 to 800 V (P0296 = 2) 585 to 800 V (P0296 = 3) 585 to 800 V (P0296 = 4) 809 to 1000 V (P0296 = 5) 809 to 1000 V (P0296 = 6) 924 to 1200 V (P0296 = 7) 924 to 1200 V (P0296 = 8)	Factory Setting:	400 V 800 V 800 V 800 V 800 V 1000 V 1000 V 1000 V 1200 V
Properties:	V/f and VVV		
Access groups via HMI:	<input type="checkbox"/> 01 PARAMETER GROUPS <input type="checkbox"/> 27 V/f DC Volt. Limit.		

Description:

It is the actuation level of the DC link voltage limitation function for the V/f mode.



Setting of P0151 value:

- a) The P0151 factory setting leaves inactive the DC link voltage limitation function for the V/f mode. In order to activate it, one must reduce the value of P0151 as suggested in the [Table 9.2 on page 9-13](#).

Table 9.2 - Recommended actuation levels for the DC link regulation

Inverter V _{nom}	220/230 V	380 V	400/415 V	440/460 V	480 V	500/525 V	550/575 V	600 V	660/690 V
P0296	0	1	2	3	4	5	6	7	8
P0151	375 V	618 V	675 V	748 V	780 V	893 V	972 V	972 V	1174 V

- b) In case DC link overvoltage (F022) keeps happening during the deceleration, reduce the value of P0151 gradually or increase the deceleration ramp time (P0101 and/or P0103).
- c) If the supply line is permanently at a voltage level that results in a DC link voltage higher than the P0151 setting, it will not be possible to decelerate the motor. In this case, reduce the line voltage or increase the value of the P0151 setting.
- d) If, even with the procedures above, it is not possible to decelerate the motor in the necessary time, use the dynamic braking (Refer to the [Chapter 14 DYNAMIC BRAKING on page 14-1](#)).

P0152 – DC Link Voltage Regulator Proportional Gain

Adjustable Range:	0.00 to 9.99	Factory Setting:	1.50
Properties:	V/f and VVV		
Access groups via HMI:	<div style="border: 1px solid black; padding: 2px; display: inline-block;">01 PARAMETER GROUPS</div> <div style="border: 1px solid black; padding: 2px; display: inline-block; margin-left: 20px;">27 V/f DC Volt. Limit.</div>		

Description:

It defines the DC Link Voltage Regulator proportional gain (refer to the [Figure 9.12 on page 9-11](#)).

P0152 multiplies the DC link voltage error, i.e., Error = actual DC link voltage – (P0151), and it is normally used to prevent overvoltage in applications with eccentric loads.

9.5 ENERGY SAVING FUNCTION

Induction motors are designed considering an optimized efficiency for operation with rated flux and torque between 75 % and 100 % of the rated value.

In order to increase the efficiency of induction motors under reduced load conditions, there is an energy saving function available on the CFW11 inverters that reduces voltage/flux with partial loads. The lower the load, the greater the possibility to reduce the voltage/flux and, therefore, the greater the energy savings.

The energy saving function is enabled by setting $P0586 = 1$. According to the default parameterization, the function is enabled when the applied load is smaller than the value set in P0588 and the speed is greater than P0590. Additionally, in some cases it is necessary to increase the value of parameter P0589 to limit the minimum voltage/flux to a greater value so as to prevent motor stalling (because the torque capacity is smaller when the voltage/flux is reduced).



NOTE!

The energy saving function is not available for the VVW control mode.

P0586 – Energy Saving Function Configuration

Adjustable Range:	0 = Off 1 = On	Factory Setting: 0
Properties:	V/f and Vector	
Access groups via HMI:	<input type="checkbox"/> 01 PARAMETER GROUPS <input type="checkbox"/> 45 Energy Saving	

Description:

This parameter enables the energy saving function.



NOTE!

The energy saving function cannot be used at the same time as the optimal flux function. If both are activated the inverter goes into the "Config" state.

P0587 – Energy Saving Reference Cos Phi

Adjustable Range:	0.5 to 1.00	Factory Setting: 0,9 * P0407
Properties:	V/f and Vector	
Access groups via HMI:	<input type="checkbox"/> 01 PARAMETER GROUPS <input type="checkbox"/> 45 Energy Saving	

Description:

This parameter defines the reference $\cos \varnothing$ for the energy saving function.

It is automatically adjusted according to parameter P0407. It assumes the value of $0.9 \times P0407$ whenever P0407 is changed. If necessary, the value of P0587 can be manually set to the desired value.

For the proper operation of the energy saving function, the motor rated power factor (P0407) must be adjusted according to the motor nameplate.

P0588 – Energy Saving Maximum Torque Current

Adjustable Range:	0 to 100 %	Factory Setting:	60 %
Properties:	V/f and Vector		
Access groups via HMI:	<div style="border: 1px solid black; padding: 2px; display: inline-block;">01 PARAMETER GROUPS</div> <div style="border: 1px solid black; padding: 2px; display: inline-block; margin-left: 20px;">45 Energy Saving</div>		

Description:

This parameter defines the torque value that enables or disables the energy saving function. The energy saving function is enabled with torque smaller than P0588.

P0589 – Minimum Voltage or Flux Energy Saving

Adjustable Range:	40 to 80 %	Factory Setting:	40 %
Properties:	V/f and Vector		
Access groups via HMI:	<div style="border: 1px solid black; padding: 2px; display: inline-block;">01 PARAMETER GROUPS</div> <div style="border: 1px solid black; padding: 2px; display: inline-block; margin-left: 20px;">45 Energy Saving</div>		

Description:

This parameter sets the minimum voltage value for scalar control or flux control for vector control which can be applied to the motor when the energy saving function is active.

The percentage value adjusted in P0589 corresponds to the voltage obtained by the V/F curve for a given speed. E.g.: If P0589 = 40 %, P0400 = 400 V, P0403 = 60 Hz and output frequency 30 Hz. The voltage obtained by the V/F curve is $400 \times (30/60) = 200$ V. In this case, the minimum voltage that can be applied to the motor is $40 \% \times 200 = 80$ V.

The effect of parameter P0589 on the flux for vector control can be observed on analog outputs AO1 to AO4 option 14 (Flux EconEnergy).



NOTE!

In some cases, with sensorless control at low speed, for instance, it is necessary to increase the value of parameter P0589 to limit the minimum flux value to a greater value in order to prevent motor stalling.

P0590 – Energy Saving Minimum Speed

Adjustable Range:	0 to 18000 rpm	Factory Setting:	600 (525) rpm
Properties:	V/f and Vector		
Access groups via HMI:	<div style="border: 1px solid black; padding: 2px; display: inline-block;">01 PARAMETER GROUPS</div> <div style="border: 1px solid black; padding: 2px; display: inline-block; margin-left: 20px;">45 Energy Saving</div>		

Description:

This parameter defines the minimum speed value at which the energy saving function will remain active. That is, for speeds greater than P0590, the energy saving function is activated.

The hysteresis for the minimum speed level is of 2 Hz.

P0591 – Hysteresis for the Maximum Torque Level

Adjustable Range:	0 to 30 %	Factory Setting:	10 %
Properties:	V/f and Vector		
Access groups via HMI:	<div style="border: 1px solid black; padding: 2px; display: inline-block;">01 PARAMETER GROUPS</div> <div style="border: 1px solid black; padding: 2px; display: inline-block; margin-left: 20px;">45 Energy Saving</div>		

Description:

This parameter sets the hysteresis for the maximum torque current (P0588) to enable or disable the energy saving function. If P0588 = 60 % and P0591 = 10 %, the energy saving function is activated when the load torque is smaller than 60 %, and it will only be disabled when the load torque is greater than 70 %.

P0600 – Firmware Update

Adjustable Range:	0 = Inactive 1 = Inverter -> Memory Card 2 = Memory Card -> Inverter	Factory Setting:	0
Properties:	CFG		
Access groups via HMI:	<div style="border: 1px solid black; padding: 2px; display: inline-block;">06 BACKUP PARAMETERS</div>		

Description:

This function allows saving the inverter firmware to the Flash Memory Module (MMF) or loading the MMF firmware to the inverter.

Table 9.3 - Options of parameter P0600

P0600	Action
0	Inactive: no action
1	Inverter -> MemCard: saves the inverter firmware on the MMF. When starting this process, the inverter will go to config, and when finishing parameter, P0600 returns to 0 automatically
2	MemCard -> Inverter: loads the MMF firmware to the inverter. When starting the process, the inverter goes to config and displays the message "Firmware update; do not shut down the inverter" followed by another message "HMI will indicate lost communication". At the end the inverter resumes communication and P0600 returns to 0 automatically

9.6 TART-UP IN THE V/F CONTROL MODE



NOTE!

Read the whole CFW-11 user's manual before installing, powering or operating the inverter.

Sequence for installation, verification, powering and start-up:

- a) **Install the inverter:** according to the chapter 3 – Installation and Connection of the CFW-11 user's manual, wiring all the power and control connections.
- b) **Prepare the inverter and apply power:** according to the section 5.1 - Prepare for Start-Up, of the CFW-11 user's manual.
- c) **Adjust the password P0000 = 5:** according to the [Section 5.3 PASSWORD SETTING IN P0000 on page 5-3](#), of this manual.
- d) **Adjust the inverter to operate with the application line and motor:** execute the Oriented Start-up routine according to the item 5.2.2 - Oriented Start-Up, of the CFW-11 user's manual. Refer to the [Section 11.7 MOTOR DATA \[43\] on page 11-10](#), of this manual.
- e) **Setting of specific parameters and functions for the application:** program the digital and analog inputs and outputs, HMI keys, etc., according to the application needs.



For applications:

- That are simple, which can use the factory settings programming for the digital and analog inputs and outputs, use the Menu "Basic Application". Refer to the item 5.2.3 - Setting Basic Application Parameters, of the CFW-11 user's manual.
- That require only the digital and analog inputs and outputs with programming different from the factory settings, use the Menu "I/O Configuration".
- That need functions as Flying Start, Ride-Through, DC Braking, Dynamic Braking, etc., access and modify those functions parameters by means of the Menu "Parameter Groups".

10 VVW CONTROL

The VVW (Voltage Vector WEG) control mode uses a control method with intermediate performance between V/f and Sensorless Vector. Refer to the [Figure 10.1 on page 10-2](#) block diagram.

The main advantage compared to the V/f control is the better speed regulation with higher torque capability at low speeds (frequencies below 5 Hz), allowing a sensible improvement of the inverter performance in permanent regimen. Comparing to the Sensorless Vector, the settings are simpler and easier.

The VVW control uses the stator current measurement, the stator resistance value (that can be obtained with the self-tuning routine) and the induction motor nameplate data to perform automatically the torque estimation, the output voltage compensation and consequently the slip compensation, replacing the function of the parameters P0137 and P0138.

In order to obtain a good speed regulation in permanent regimen, the slip frequency is calculated based on the load estimated torque, which considers the existent motor data.

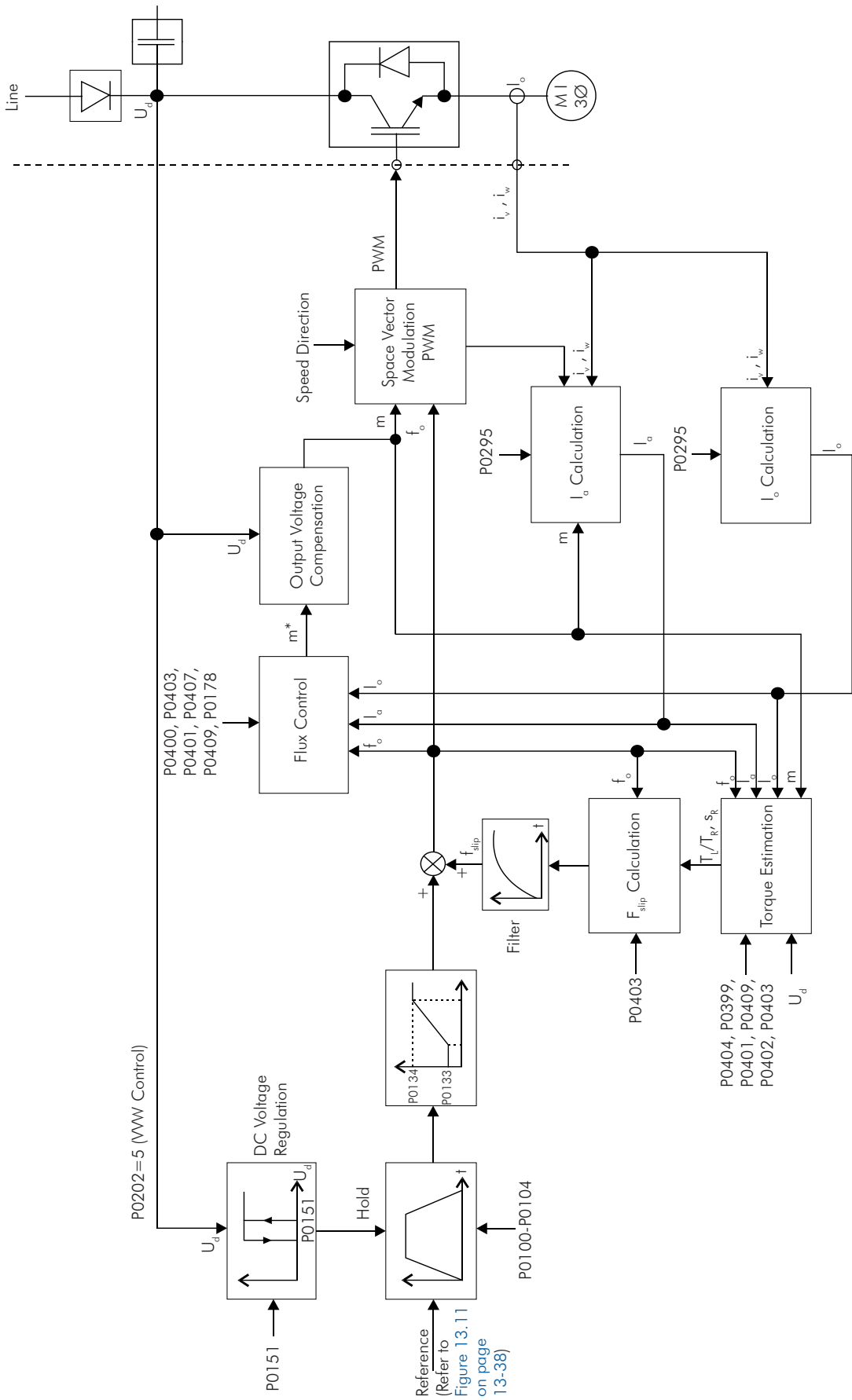

Figure 10.1 - VVW control block diagram

10.1 VVW CONTROL [25]

The parameter group [25] – VVW Control – contains only 5 parameters related to that function: P0139, P0140, P0141, P0202 and P0397.

However, since the parameters P0139, P0140, P0141 and P0202 were already presented in the [Section 9.1 V/F CONTROL \[23\] on page 9-2](#), only the parameter P0397 will be described next.

P0397 – Slip Compensation

Adjustable Range:	0 = Inactive 1 = Active Motorizing/Regenerating 2 = Active Motorizing 3 = Active Regenerating	Factory Setting: 1
Properties:	CFG and VVW	
Access groups via HMI:	<div style="border: 1px solid black; padding: 2px; display: inline-block;">01 PARAMETER GROUPS</div> <div style="border: 1px solid black; padding: 2px; display: inline-block; margin-left: 20px;">25 VVW Control</div>	

Description:

It enables or disables the slip compensation when it is motorizing or regenerating in the VVW control mode. See parameter P0138 in [Section 9.1 V/F CONTROL \[23\] on page 9-2](#) for further details on slip compensation.

10.2 MOTOR DATA [43]

The parameters for the used motor data setting are listed in this group. They must be adjusted according to the motor nameplate data (P0398 to P0406, except P0405) and by means of the Self-Tuning or from data of the motor data sheet (other parameters).

In this section only the parameters P0399 and P0407 will be presented, the others are presented in the [Section 11.7 MOTOR DATA \[43\] on page 11-10](#).

P0398 – Motor Service Factor

Refer to the [Section 11.7 MOTOR DATA \[43\] on page 11-10](#), for more information.

P0399 – Motor Rated Efficiency

Adjustable Range:	50.0 to 99.9 %	Factory Setting: 67.0 %
Properties:	CFG and VVW	
Access groups via HMI:	<div style="border: 1px solid black; padding: 2px; display: inline-block;">01 PARAMETER GROUPS</div> <div style="border: 1px solid black; padding: 2px; display: inline-block; margin-left: 20px;">43 Motor Data</div>	

Description:

It sets the motor rated efficiency.

This parameter is important for the VVW control precise operation. The inaccurate setting implies in incorrect calculation of the slip compensation and consequently an imprecise speed control.

P0400 – Motor Rated Voltage

P0401 – Motor Rated Current

P0402 – Motor Rated Speed

P0403 – Motor Rated Frequency

P0404 – Motor Rated Power

P0406 – Motor Ventilation

Refer to the [Section 11.7 MOTOR DATA \[43\]](#) on page 11-10, for more information.

P0407 – Motor Rated Power Factor

Adjustable Range:	0.50 to 0.99	Factory Setting:	0.68
Properties:	CFG and VVW		
Access groups via HMI:	<div style="border: 1px solid black; padding: 2px; display: inline-block;">01 PARAMETER GROUPS</div> <div style="border: 1px solid black; padding: 2px; display: inline-block; margin-left: 20px;">43 Motor Data</div>		

Description:

It is the motor power factor setting, according to the motor nameplate data (cos Ø).

This parameter is important for the VVW control operation. The inaccurate setting will imply in incorrect calculation of the slip compensation.

The default value of this parameter is adjusted automatically when the parameter P0404 is changed. The suggested value is valid for three-phase, IV pole WEG motors. For other motor types the setting must be done manually.

P0408– Run Self-Tuning

P0409 – Motor Stator Resistance (Rs)

P0410 – Motor Magnetizing Current (I_m)

Refer to the [Item 11.8.5 Self-Tuning \[05\]](#) and [\[94\]](#) on page 11-24, for more information.

P0414 – Motor Magnetization Time

Adjustable Range:	0.000 to 9.999 s	Factory Setting:	0.000 s
Properties:			
Access groups via HMI:	01 PARAMETER GROUPS		
	43 Motor Data		

Description:

This parameter allows setting a motor magnetization time different from 2 x P0412, and then this is the time the inverter takes into account to indicate the motor is general enabled (or magnetized) after receiving the general enable command.



NOTE!

Value of 0.000 s disables the use of this parameter, and the inverter takes into account the time of 2 x P0412 (Motor Rotor Time Constant) to indicate the motor is general enabled.

10.3 VVW CONTROL MODE START-UP



NOTE!

Read the whole CFW-11 user's manual before installing, powering or operating the inverter.

Sequence for installation, verification, powering and start-up:

- a) **Install the inverter:** according to the chapter 3 - Installation and Connection, of the CFW-11 user's manual, wiring all the power and control connections.
- b) **Prepare the inverter and apply power:** according to the section 5.1 - Prepare for Start-Up, of the CFW-11 user's manual.
- c) **Adjust the password P0000 = 5:** according to the [Section 5.3 PASSWORD SETTING IN P0000 on page 5-3](#), of this manual.
- d) **Adjust the inverter to operate with the application line and motor:** by means of the "Oriented Start-up" Menu access **P0317** and change its content to 1, which makes the inverter initiate the "Oriented Start-up" routine.

The "Oriented Start-up" routine presents on the keypad (HMI) the main parameters in a logical sequence. The setting of these parameters prepares the inverter for operation with the application line and motor. Verify the step by step sequence in the [Figure 10.2 on page 10-8](#).

The setting of the parameters presented in this operation mode results in the automatic modification of the content of other inverter parameters and/or internal variables, as indicated in the [Figure 10.2 on page 10-8](#). In this way one gets a stable operation of the control circuit with adequate values to obtain the best motor performance.

During the "Oriented Start-up" routine the "Config" (Configuration) status will be indicated on the top left part of the keypad (HMI).



Parameters related to the motor:

- Program the contents of parameters from P0398 to P0407 directly with the motor nameplate data. Refer to the [Section 11.7 MOTOR DATA \[43\] on page 11-10](#).
- Options for the setting of parameter P0409:
 - I – Automatic by the inverter, performing the self-tuning routine selected in P0408.
 - II – From the motor test data sheet, supplied by the manufacturer. Refer to the [Item 11.7.1 Adjustment of the Parameters P0409 to P0412 Based on the Motor Data Sheet on page 11-15](#), in this manual.
 - III – Manually, copying the parameters content of another CFW-11 that runs an identical motor.

e) **Setting of specific parameters and functions for the application:** program the digital and analog inputs and outputs, HMI keys, etc., according to the application needs.



For applications:

- That are simple, which can use the factory settings programming for the digital and analog inputs and outputs, use the Menu "Basic Application". Refer to the item 5.2.3 - Setting Basic Application Parameters, of the CFW-11 user's manual.
- That require only the digital and analog inputs and outputs with programming different from the factory settings, use the Menu "I/O Configuration".
- That need functions as Flying Start, Ride-Through, DC Braking, Dynamic Braking, etc., access and modify those function parameters by means of the Menu "Parameter Groups".

Seq.	Action/Result	Display Indication
1	- Monitoring Mode. - Press "Menu" (right "soft key").	
2	- The group "00 ALL PARAMETERS" is already selected.	
3	- The group "01 PARAMETER GROUPS" is selected.	
4	- The group "02 ORIENTED START-UP" is then selected. - Press "Select".	
5	- The parameter "Oriented Start-up P0317:No" is already selected. - Press "Select".	
6	- The content of "P0317 = [000] No" is showed.	
7	- The content of the parameter is changed to "P0317 = [001] Yes" - Press "Save".	
8	- In this moment the Oriented Start-up routine is initiated and the "Config" status is indicated at the top left part of the keypad (HMI). - The parameter "Language P0201: English" is already selected. - If necessary, change the language by pressing "Select", next and to select the language and then press "Save".	

Seq.	Action/Result	Display Indication
9	- Set the content of P0202 pressing "Select". - Next press until selecting the option "[005] VVW", and then press "Save".	
10	- If necessary, change the content of P0296 according to the used line voltage. Therefore press "Select". This change will affect P0151, P0153, P0185, P0321, P0322, P0323 and P0400.	
11	- If necessary, change the content of P0298 according to the inverter application. Therefore press "Select". This change will affect P0156, P0157, P0158, P0401 and P0404. The actuation time and level of the IGBTs overload protection will be affected.	
12	- If necessary, change the content of P0398 according to the motor service factor. Therefore press "Select". This change will affect the value of the current and the time for the actuation of the motor overload protection.	
13	- If necessary, change the content of P0399 according to the rated motor efficiency. Therefore press "Select".	











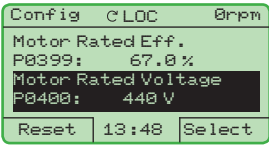

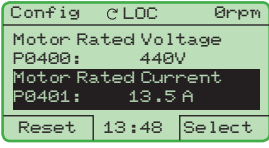

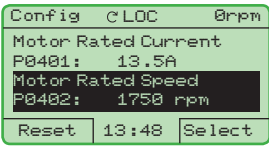

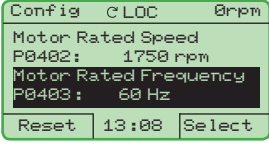
Seq.	Action/Result	Display Indication
14	- If necessary, change the content of P0400 according to the motor rated voltage. Therefore press "Select". This change corrects the output voltage by the factor $x = P0400/P0296$. 	
15	- If necessary, change the content of P0401 according to the motor rated current. Therefore press "Select". This change will affect P0156, P0157, P0158 and P0410. 	
16	- If necessary, change the content of P0402 according to the motor rated speed. Therefore press "Select". This change will affect P0122 to P0131, P0133, P0134, P0182, P0208, P0288 and P0289. 	
17	- If necessary, change the content of P0403 according to the motor rated frequency. Therefore press "Select". 	
18	- If necessary, change the content of P0404 according to the motor rated power. Therefore press "Select". This change will affect P0410. 	
19	- If necessary, change the content of P0406 according to the motor ventilation type. Therefore press "Select". This change will affect P0156, P0157, P0158, P0399, and P0407. 	
20	If necessary, change the content of P0407 according to the motor rated power factor. Therefore press "Select". 	
21	- At this point the keypad (HMI) presents the option for running the "Self-tuning". <u>Whenever it is possible, one must run the Self-tuning.</u> - Thus, press "Select" to access the parameter P0408 and then  to select the option "[001] No Rotation". Refer to the Item 11.8.5 Self-Tuning [05] and [94] on page 11-24, for more details. - Next press "Save".	 
22	- After this the Self-tuning routine is initiated and the "SelfTun" status is indicated at the top left part of the keypad (HMI). - The keypad (HMI) will initiate the routine presenting "P0409 Estimating Rs". Wait until the end of the Self-tuning routine.	
23	- Once the Self-tuning routine has finished, the inverter returns to the Monitoring Mode and it is ready to operate.	

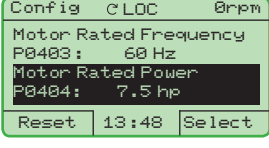
Figure 10.2 - VVW mode Oriented Start-up

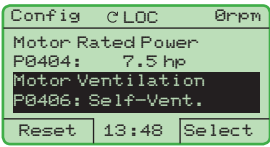
11 VECTOR CONTROL

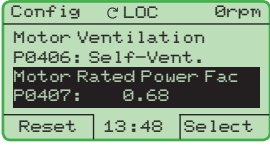
It consists in the control type based on the separation of the motor current into two components:

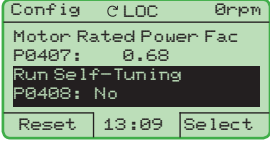
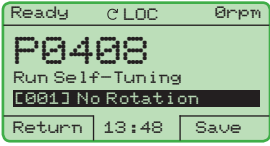
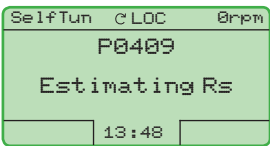
- ☑ Flux producing current I_d (oriented with the motor electromagnetic flux).
- ☑ Torque producing current I_q (perpendicular to the motor flux vector).

The I_d current is related to the motor electromagnetic flux, while the I_q current is directly related to the torque produced at the motor shaft. With this strategy one gets the so called decoupling, i.e., one can control the motor flux and torque independently by controlling the I_d and I_q currents respectively.

Since these currents are represented by vectors that rotate at the synchronous speed, when observed from a stationary referential, a referential transformation is done so that they are changed to the synchronous referential. In the synchronous referential these values become DC values proportional the respective vector amplitudes. This simplifies considerably the control circuit.

When the I_d vector is aligned with the motor flux, it can be said that the vector control is orientated. Therefore it is necessary that the motor parameters be correctly adjusted. Some of those parameters must be programmed with the motor nameplate data and others obtained automatically through self-tuning or from the motor data sheet supplied by the manufacturer.

The [Figure 11.2 on page 11-4](#) presents the block diagram for the vector control with encoder and the [Figure 11.1 on page 11-2](#) for the sensorless vector control. The information of the speed, as well as of the currents measured by the inverter, will be used to obtain the correct vector orientation. In the vector with encoder control case, the speed is obtained directly from the encoder signal, while in the sensorless vector control there is an algorithm which estimates the speed, based in the output currents and voltages.

The vector control measures the current, separates the flux and torque portions and transforms these variables to the synchronous referential. The motor control is accomplished by imposing the desired currents and comparing them with the actual values.

It is recommended that the motor current be greater than 1/3 of the inverter rated current.

11.1 SENSORLESS CONTROL AND WITH ENCODER

The Sensorless Vector Control is recommended for the majority of the applications, because it allows the operation in a speed variation range of 1:100, accuracy in the speed control of 0.5 % of the rated speed, high starting torque and fast dynamic response.

Another advantage of this control type is the greater robustness against sudden line voltage and load changes, avoiding unnecessary overcurrent trips.

The necessary settings for the good operation of the sensorless vector control are done automatically. Therefore the used motor must be connected to the CFW-11 inverter.

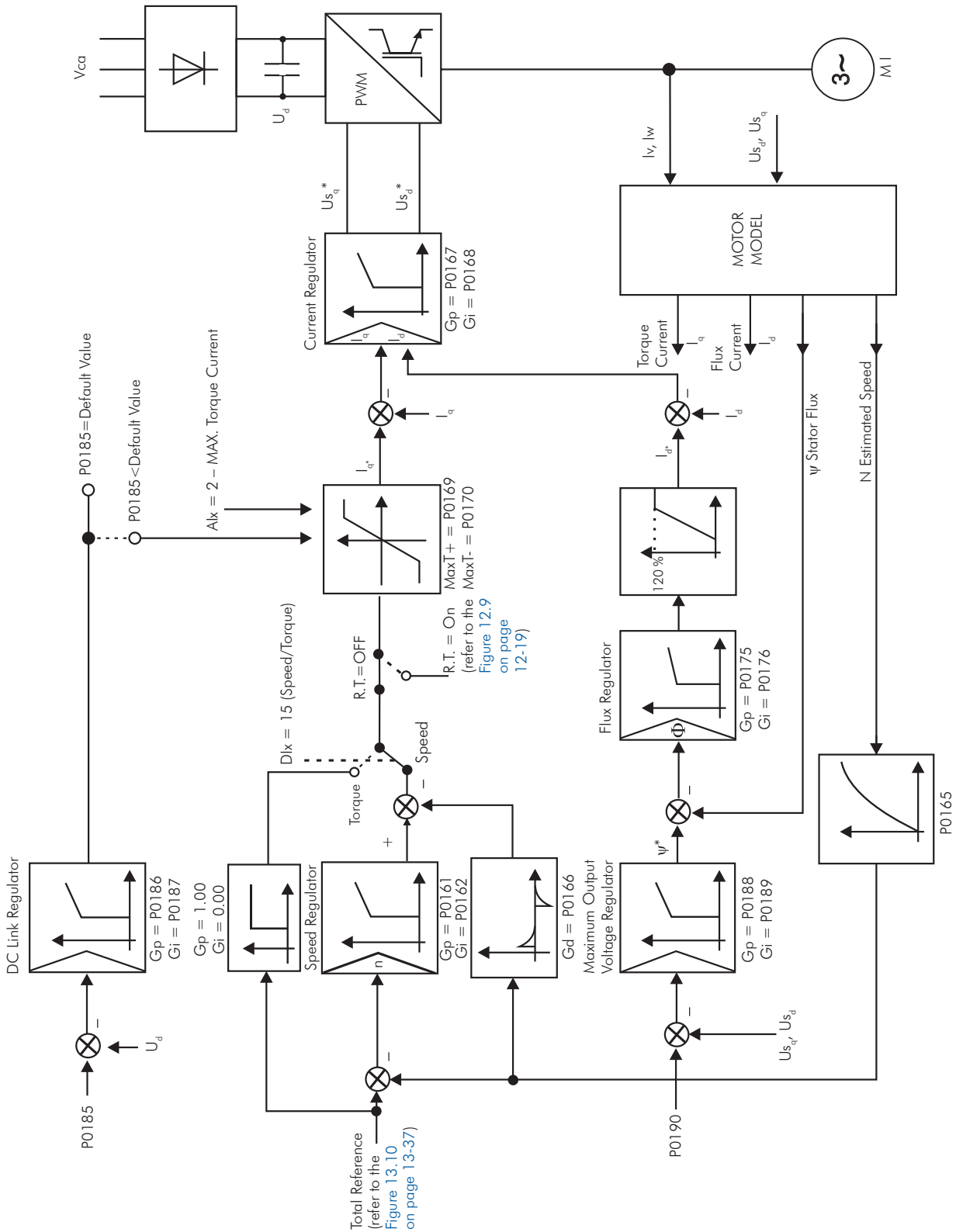

Figure 11.1 - Sensorless vector control block diagram

The Vector Control with Encoder presents the same advantages of the sensorless control previously described, with the following additional benefits:

- ☑ Torque and speed control down to 0 (zero) rpm.
- ☑ Speed control accuracy of 0.01 % (if the 14-bit analog speed reference via optional board IOA-01 is used, or if digital references are used, for instance via keypad (HMI), Profibus DP, DeviceNet, etc.).

The vector control with encoder needs the accessory for the incremental encoder interface ENC-01 or ENC-02. For more details on the installation and connection, refer to the optional board manual.

11.2 I/F MODE (SENSORLESS)



NOTE!

It is activated automatically at low speeds if $P0182 > 3$ and when the Control Mode is Sensorless Vector ($P0202 = 3$).

The operation at the low speed region may present instability. In this region the motor operation voltage is also very low, being difficult to be measured accurately.

In order to keep a stable operation of the inverter in that region, the automatic commutation occurs, from sensorless mode to the so called I/f mode, which is a scalar control with imposed current. Scalar control with imposed current means a current control with a constant reference value, adjusted in a parameter and controlling only the frequency in an open loop.

The parameter P0182 defines the speed below which the transition to I/f mode occurs and the parameter P0183 defines the value of the current to be applied to the motor.

The minimum speed recommended for the operation of the Sensorless Vector Mode is 18 rpm for 60 Hz IV pole motors, and 15 rpm for 50 Hz IV pole motors. If $P0182 \leq 3$ rpm the inverter will always operate in Sensorless Vector mode, i.e., the I/f function will be disabled.

11.3 SELF-TUNING

Some motor parameters that are not available on the motor nameplate, necessary for the operation of the sensorless vector or vector with encoder control, are estimated: stator resistance, motor flux leakage inductance, rotor time constant T_r , the rated magnetizing current of the motor and the mechanic time constant of the motor and the driven load. These parameters are estimated with the application of voltages and currents to the motor.

The parameters related to the regulators used by the vector control, as well as other control parameters, are adjusted automatically in function of the motor parameters estimated through the self-tuning routine. The best self-tuning results are obtained with a preheated motor.

The parameter P0408 controls the self-tuning routine. Depending on the chosen option some parameters can be obtained from tables that are valid for WEG motors.

In the option $P0408 = 1$ (No Rotation) the motor remains stopped throughout the self-tuning. The magnetizing current value (P0410) is obtained from a table, valid for WEG motors up to 12 poles.

In the option $P0408 = 2$ (Run for I_m) the value of P0410 is estimated with the motor rotating and the load decoupled from the motor shaft.

In the option $P0408 = 3$ (Run for T_m) the value of P0413 (Mechanic time constant – T_m) is estimated with the motor rotating. It must be done, preferably, with the load coupled to the motor.



NOTE!

Every time that P0408 = 1 or 2 the parameter P0413 (Mechanic time constant – T_m) will be adjusted for a value close to the motor rotor mechanic time constant. Therefore, the motor rotor inertia (table data valid for WEG motors), the inverter rated voltage and current, are taken into consideration.

P0408 = 2 (Run for I_m) in the vector with encoder mode (P0202 = 4): After finishing the self-tuning routine, couple the load to the motor and set P0408 = 4 (Estimate T_m). In this case P0413 will be estimated taking into account also the driven load.

If the option P0408 = 2 (Run for I_m) is executed with the load coupled to the motor, an incorrect value of P0410 (I_m) may be estimated. This will implicate in estimation error for P0412 (rotor time constant - T_r) and for P0413 (mechanic time constant – T_m). Overcurrent fault (F071) may also occur during the inverter operation.

Note: The term "load" includes everything that might be coupled to the motor shaft, for instance, gearbox, inertia disk, etc.

In the option P0408 = 4 (Estimate T_m) the self-tuning routine estimates only the P0413 (Mechanic time constant – T_m) value, with the motor rotating. It must be done, preferably, with the load coupled to the motor.

During its execution, the self-tuning routine can be canceled by pressing the  key, provided that the values of P0409 through P0413 be all different from zero.

For more details on the self-tuning parameters, refer to the [Item 11.8.5 Self-Tuning \[05\] and \[94\]](#) on page 11-24, in this manual.



Alternatives for the acquisition of the motor parameters:

Instead of running the self-tuning, it is possible to obtain the values for P0409 to P0412 in the following manner:

- From the motor test data sheet that can be supplied by its manufacturer. Refer to the [Item 11.7.1 Adjustment of the Parameters P0409 to P0412 Based on the Motor Data Sheet on page 11-15](#).
- Manually, by copying the contents of the parameters from another CFW-11 inverter that uses an identical motor.

11.4 OPTIMAL FLUX FOR SENSORLESS VECTOR CONTROL



NOTE!

Active function only on the Sensorless Vector mode (P0202 = 3), if P0406 = 2.

The Optimal Flux function can be used for driving some types of WEG motors (*) making it possible the operation at low speed with rated torque without the need of forced ventilation on the motor. The frequency range for operation is 12:1, i.e., from 5 Hz to 60 Hz for 60 Hz rated frequency motors and from 4.2 Hz to 50 Hz for 50 Hz rated frequency motors.

**NOTE!**

(*) WEG motors that can be used with the Optimal Flux function: Nema Premium Efficiency, Nema High Efficiency, IEC Premium Efficiency, IEC Top Premium Efficiency and "Alto Rendimento Plus".

When this function is activating, the motor flux is controlled in a way to reduce their electric losses on slow speeds. That flux is dependent of the torque current filtered (P0009). The Optimal Flux function is unnecessary in motors with independent ventilation.

11.5 TORQUE CONTROL

In vector control modes sensorless or with encoder, it is possible to use the inverter in torque control mode instead of using it in speed control mode. In this case the speed regulator must be kept saturated and the imposed torque value is defined by the torque limits in P0169/P0170.

Performance of the torque control:

Vector control with encoder:

Torque control range: 10 % to 180 %.

Accuracy: ± 5 % of the rated torque.

Sensorless vector control:

Torque control range: 20 % to 180 %.

Accuracy: ± 10 % of the rated torque.

Minimum operating frequency: 3 Hz.

When the speed regulator is positively saturated, i.e., forward speed direction defined in P0223/P0226, the value for the torque current limitation is adjusted in P0169. When the speed regulator is negatively saturated, i.e., reverse speed direction, the value for the torque current limitation is adjusted in P0170.

The torque at the motor shaft (T_{motor}) in % is given by the formula:

(*) The formula described next must be used for "+" torque. For "-" torque, replace P0169 by P0170.

$$T_{\text{motor}} (\%) = P0169 \cdot k$$

Where the factor k is defined by:

- region of constant flux (constant torque and below or equal to the synchronous speed): $k = 1$.

- region of field weakening (region of constant power; higher than the synchronous speed):

$k = (N_{\text{sync}} / P0002) \times (P0190 / P0400)$. Whose N_{sync} is the motor synchronous speed in RPM.



NOTE!

For torque control in the sensorless vector mode ($P0202 = 3$), observe:

- The torque limits ($P0169/P0170$) must be higher than 30 % to assure the motor starting. After the start and with the motor rotating above 3 Hz, they can be reduced, if necessary, to values below 30 %.
- For torque control applications with frequencies until to 0 Hz, use the vector with encoder control mode ($P0202 = 4$).
- In the vector with encoder control type set the speed regulator for the mode "saturated" ($P0160 = 1$), besides keeping the regulator in the saturated state.



NOTE!

The motor rated current must be equivalent to the CFW-11 rated current, in order that the torque control has the best possible accuracy.



Settings for the torque control:

Torque limitation:

1. Via parameters $P0169$, $P0170$ (through the keypad (HMI), Serial or Fieldbus). Refer to the [Item 11.8.6 Torque Current Limitation \[95\] on page 11-29](#).
2. Through the analog inputs $AI1$, $AI2$, $AI3$ or $AI4$. Refer to the [Item 13.1.1 Analog Inputs \[38\] on page 13-1](#), option 2 (maximum torque current).

Speed reference:

3. Set the speed reference 10 %, or more, higher than the working speed. This assures that the speed regulator output remains saturated at the maximum value allowed by the torque limit adjustment.



NOTE!

The torque limitation with the saturated speed regulator has also a protection (limitation) function. E.g.: for a winder, when the material being wound brakes, the regulator leaves the saturated condition and starts controlling the motor speed, which will be kept at the speed reference value.

11.6 OPTIMAL BRAKING



NOTE!

Only activated on the Vector with Encoder mode ($P0202 = 3$ or 4), when $P0184 = 0$, $P0185$ is smaller than the standard value and $P0404 < 21$ (75 CV).



NOTE!

The occurrence of optimal braking may cause at the motor:

- Increase of the vibration level.
- Increase of the acoustic noise.
- Increase of the temperature.

Verify the impact of those effects in the application before using the optimal braking.

It is a function that helps the motor controlled braking, eliminating in many cases the need of additional braking IGBT and braking resistor.

The Optimal Braking makes it possible braking the motor with a higher torque than the one obtained with traditional methods, as for instance, the braking by the injection of direct current (DC braking). In the DC braking case, only the losses in the motor rotor are used to dissipate the energy stored as the mechanic load inertia, rejecting the total friction losses. With the Optimal Braking, in the other hand, the total losses in the motor, as well as the total inverter losses, are used. It is possible to get a braking torque roughly 5 times greater than with DC braking.

In the [Figure 11.3 on page 11-10](#) the Torque x Speed curve of a typical 10 hp/7.5 kW IV pole motor is presented. The braking torque obtained at the rated speed, for an inverter with a torque limit (P0169 and P0170) adjusted in a value equal to the motor rated torque, is supplied by the TB1 point on the [Figure 11.3 on page 11-10](#). The value of TB1 is on the function of the motor efficiency, and it is defined by the following expression, being despised the attrition losses:

$$TB1 = \frac{1-\eta}{\eta}$$

Where:

η = motor efficiency

In the [Figure 11.3 on page 11-10](#) case, the efficiency of the motor for the rated load is $\eta = 0.84$ (or 84 %), which results in $TB1 = 0.19$ or 19 % of the motor rated torque.

The braking torque, starting from the TB1 point, varies in the inverse ratio of the speed (1/N). At low speeds, the braking torque reaches the torque limit of the inverter. In the [Figure 11.3 on page 11-10](#) case, the torque reaches the torque limitation (100 %) when the speed is less than approximately 20 % of the rated speed.

It is possible to increase the braking torque by increasing the inverter current limitation during the optimal braking (P0169) – torque in the forward speed direction or P0170 – reverse).

Generally smaller motors have lower efficiency because they present more losses. Therefore, comparatively higher braking torque is obtained if they are compared to bigger motors.

Examples: 1 hp/0.75 kW, IV poles: $\eta = 0.76$ resulting in $T_{B1} = 0.32$.
 20 hp/15.0 kW, IV poles: $\eta = 0.86$ resulting in $T_{B1} = 0.16$.

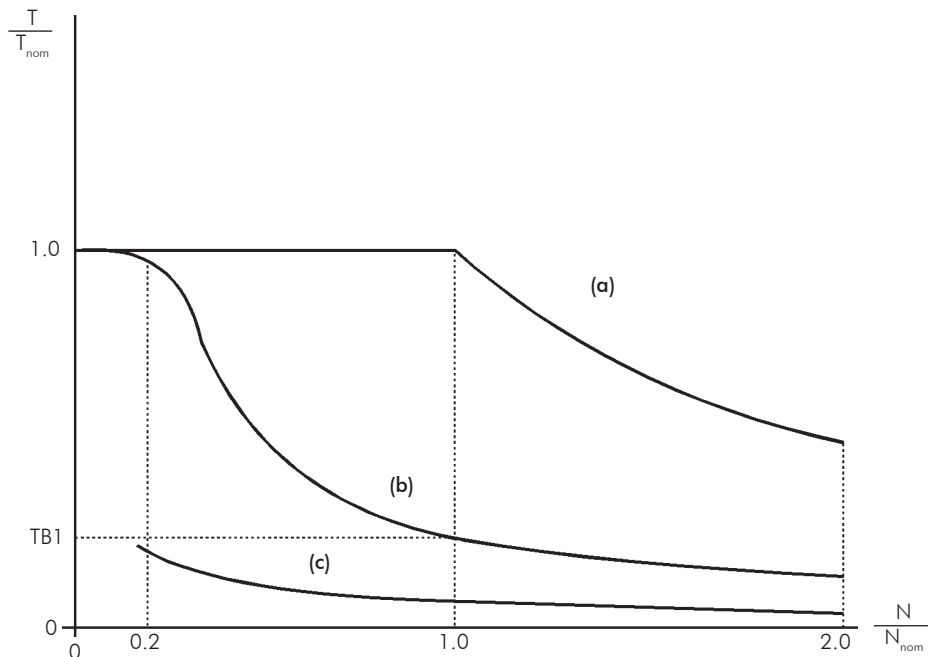

Figure 11.3 - $T \times N$ curve for Optimal Braking with a typical 10 hp/7.5 kW motor, driven by an inverter with the torque adjusted at a value equal to the motor rated torque

- (a)** Torque generated by the motor in normal operation, driven by the inverter in the "motor mode" (load resistant torque).
- (b)** Braking torque generated by the Optimal Braking use.
- (c)** Braking torque generated by the DC braking use.



In order to use the Optimal Braking:

(a) Activate the optimal braking by setting $P0184 = 0$ (DC Link Regulation Mode = with losses) and set the DC link regulation level in $P0185$, as presented in the [Item 11.8.7 DC Link Regulator \[96\]](#) on page 11-30, with $P0202 = 3$ or 4 and $P0404$ smaller than 21 (75hp).

(b) In order to enable and disable the Optimal Braking via a digital input, set one of the inputs (DIx) for "DC Link Regulation". ($P0263 \dots P0270 = 25$ and $P0184 = 2$).

Results:

DIx = 24 V (closed): Optimal Braking is active, equivalent to $P0184 = 0$.

DIx = 0 V (open): Optimal Braking is inactive.

11.7 MOTOR DATA [43]

In this group are listed the parameters for the setting of the used motor data. Adjust them according to the motor nameplate data ($P0398$ to $P0406$), except $P0405$, and by means of the self-tuning routine or with the data existent in the motor data sheet (the other parameters). In the Vector Control mode the parameters $P0399$ and $P0407$ are not used.

P0398 – Motor Service Factor

Adjustable Range:	1.00 to 1.50	Factory Setting:	1.00
Properties:	CFG		
Access groups via HMI:	<div style="border: 1px solid black; padding: 2px; display: inline-block;">01 PARAMETER GROUPS</div> <div style="border: 1px solid black; padding: 2px; display: inline-block; margin-left: 20px;">43 Motor Data</div>		

Description:

It is the continuous overload capability, i.e., a reserve of power that gives the motor the capability to withstand working in adverse conditions.

Set it according to the value informed on the motor nameplate.

It affects the motor overload protection.

P0399 – Motor Rated Efficiency

Refer to the [Section 10.2 MOTOR DATA \[43\]](#) on page 10-3, for more details.

P0400 – Motor Rated Voltage

Adjustable Range:	0 to 690 V	Factory Setting:	220 V (P0296 = 0) 440 V (P0296 = 1, 2, 3 or 4) 575 V (P0296 = 5 or 6) 690 V (P0296 = 7 or 8)
Properties:	CFG		
Access groups via HMI:	<div style="border: 1px solid black; padding: 2px; display: inline-block;">01 PARAMETER GROUPS</div> <div style="border: 1px solid black; padding: 2px; display: inline-block; margin-left: 20px;">43 Motor Data</div>		

Description:

Set it according to the motor nameplate data and to the motor cable wiring in the connection box.

This value cannot be higher than the rated voltage adjusted in P0296 (Line Rated Voltage).

NOTE!

In order to validate a new P0400 setting out of the Oriented Start-up Routine it is necessary to cycle the power of the inverter.

P0401 – Motor Rated Current

Adjustable Range:	0 to 1.3x _{nom-ND}	Factory Setting:	1.0x _{nom-ND}
Properties:	CFG		
Access groups via HMI:	<div style="border: 1px solid black; padding: 2px; display: inline-block;">01 PARAMETER GROUPS</div> <div style="border: 1px solid black; padding: 2px; display: inline-block; margin-left: 20px;">43 Motor Data</div>		

Description:

Set it according to the used motor nameplate data, taking into consideration the motor voltage.

In the Guided Start-up routine the value adjusted in P0401 automatically modifies the parameters related to the motor overload protection, according to the [Table 11.2 on page 11-14](#).

P0402 – Motor Rated Speed

Adjustable Range:	0 to 18000 rpm	Factory Setting:	1750 rpm (1458 rpm)
Properties:	CFG		
Access groups via HMI:	<div style="border: 1px solid black; padding: 2px; display: inline-block;">01 PARAMETER GROUPS</div> <div style="border: 1px solid black; padding: 2px; display: inline-block; margin-left: 20px;">43 Motor Data</div>		

Description:

Set it according to the used motor nameplate data.

For V/f and VVV controls the setting is from 0 to 18000 rpm.

For vector control the setting is from 0 to 7200 rpm.

P0403 – Motor Rated Frequency

Adjustable Range:	0 to 300 Hz	Factory Setting:	60 Hz (50 Hz)
Properties:	CFG		
Access groups via HMI:	<div style="border: 1px solid black; padding: 2px; display: inline-block;">01 PARAMETER GROUPS</div> <div style="border: 1px solid black; padding: 2px; display: inline-block; margin-left: 20px;">43 Motor Data</div>		

Description:

Set it according to the used motor nameplate data.

For V/f and VVV controls the setting range goes up to 300 Hz.

For vector control the setting range is from 30 Hz to 120 Hz.

P0404 – Motor Rated Power

Adjustable Range:	0 to 60 (refer to the Table 11.1 on page 11-13)	Factory Setting:	Motor _{max-ND}
Properties:	CFG		
Access groups via HMI:	<div style="border: 1px solid black; padding: 2px; display: inline-block;">01 PARAMETER GROUPS</div> <div style="border: 1px solid black; padding: 2px; display: inline-block; margin-left: 20px;">43 Motor Data</div>		

Description:

Set it according to the used motor nameplate data.

Table 11.1 - P0404 (Motor Rated Power) setting

P0404	Motor Rated Power (hp)	P0404	Motor Rated Power (hp)
0	0.33	31	300.0
1	0.50	32	350.0
2	0.75	33	380.0
3	1.0	34	400.0
4	1.5	35	430.0
5	2.0	36	440.0
6	3.0	37	450.0
7	4.0	38	475.0
8	5.0	39	500.0
9	5.5	40	540.0
10	6.0	41	600.0
11	7.5	42	620.0
12	10.0	43	670.0
13	12.5	44	700.0
14	15.0	45	760.0
15	20.0	46	800.0
16	25.0	47	850.0
17	30.0	48	900.0
18	40.0	49	1000.0
19	50.0	50	1100.0
20	60.0	51	1250.0
21	75.0	52	1400.0
22	100.0	53	1500.0
23	125.0	54	1600.0
24	150.0	55	1800.0
25	175.0	56	2000.0
26	180.0	57	2300.0
27	200.0	58	2500.0
28	220.0	59	2900.0
29	250.0	60	3400.0
30	270.0	-	-

 **NOTE!** When adjusted via keypad (HMI), this parameter may change the parameter P0329 automatically. Refer to the [Item 12.7.2 Vector Flying Start on page 12-12](#).

P0405 – Number of Encoder Pulses

Adjustable Range:	100 to 9999 ppr	Factory Setting:	1024 ppr
Properties:	CFG		
Access groups via HMI:	01 PARAMETER GROUPS		
	43 Motor Data		

Description:
It sets the number of pulses per rotation (ppr) of the used incremental encoder.

P0406 – Motor Ventilation

Adjustable Range:	0 = Self-Ventilated 1 = Separate Ventilation 2 = Optimal Flux 3 = Extended Protection	Factory Setting: 0
Properties:	CFG	
Access groups via HMI:	<div style="border: 1px solid black; padding: 2px; display: inline-block;">01 PARAMETER GROUPS</div> <div style="border: 1px solid black; padding: 2px; display: inline-block; margin-left: 20px;">43 Motor Data</div>	

Description:

During the Oriented Start-up Routine, the value adjusted in P0406 changes the parameters related to the motor overload automatically, in the following manner:

Table 11.2 - Motor overload protection modification in function of P0406

P0406	P0156 (Overl.Curr.100 %)	P0157 (Overl.Curr.50 %)	P0158 (Overl.Curr.5 %)
0	1.05 x P0401	0.9 x P0401	0.65 x P0401
1	1.05 x P0401	1.05 x P0401	1.05 x P0401
2	1.05 x P0401	1.0 x P0401	1.0 x P0401
3	0.98 x P0401	0.9 x P0401	0.55 x P0401



ATTENTION!

Refer to the [Section 11.4 OPTIMAL FLUX FOR SENSORLESS VECTOR CONTROL](#) on page 11-6, for more details on the use of option P0406 = 2 (Optimal Flux).

P0407 – Motor Rated Power Factor

Refer to the [Section 10.2 MOTOR DATA \[43\]](#) on page 10-3, for more details.

P0408 – Run Self-Tuning

P0409 – Motor Stator Resistance (Rs)

P0410 – Motor Magnetizing Current (Im)

P0411 – Motor Flux Leakage Inductance (σls)

P0412 – Lr/Rr Constant (Rotor Time Constant – Tr)

P0413 – Tm Constant (Mechanical Time Constant)

Self-Tuning function parameters. Refer to the [Item 11.8.5 Self-Tuning \[05\]](#) and [\[94\]](#) on page 11-24.

P0414 – Motor Magnetization Time

Adjustable Range:	0.000 to 9.999 s	Factory Setting:	0.000 s
Properties:			
Access groups via HMI:	01 PARAMETER GROUPS		
	43 Motor Data		

Description:

This parameter allows setting a motor magnetization time different from 2 x P0412, and then this is the time the inverter takes into account to indicate the motor is general enabled (or magnetized) after receiving the general enable command.



NOTE!

Value of 0.000 s disables the use of this parameter, and the inverter takes into account the time of 2 x P0412 (Motor Rotor Time Constant) to indicate the motor is general enabled.

11.7.1 Adjustment of the Parameters P0409 to P0412 Based on the Motor Data Sheet

Being in the possession of the motor equivalent circuit data, it is possible to calculate the value to be programmed in the parameters from P0409 to P0412, instead of using the self-tuning to obtain them.

Input data:

Motor data sheet:

V_n = Nominal voltage informed in the motor data, in Volts;

f_n = Nominal frequency informed in the motor data, in Hz;

R_1 = resistance of the motor stator per phase, in Ohms;

R_2 = resistance of the motor rotor per phase, in Ohms;

X_1 = stator inductive reactance, in Ohms;

X_2 = rotor inductive reactance, in Ohms;

X_m = magnetizing inductive reactance, in Ohms;

I_o = motor no load current;

ω = angular speed.

$$\omega = 2 \times \pi \times f_n$$

$$R_s = R_1$$

$$I_m = I_o \times 0.95$$

$$\sigma l_s = \frac{[X_1 + (X_2 \times X_m) / (X_2 + X_m)]}{\omega}$$

$$T_r = \frac{(X_2 + X_m)}{\omega \times R_2}$$

1. For motors that allow two kinds of connection (Y / Δ or YY / ΔΔ):

☑ When the motor is connected in Y or YY:

$$P0409 = R_s$$

$$P0411 = \sigma I_s$$

☑ When the motor is connected in Δ or ΔΔ:

$$P0409 = \frac{R_s}{3}$$

$$P0411 = \frac{\sigma I_s}{3}$$

2. For motors that allow three kinds of connection (YY / ΔΔ / Δ):

☑ When, on the data sheet, it is considered connection in YY or ΔΔ and the motor is connected in YY:

$$P0409 = R_s$$

$$P0411 = \sigma I_s$$

☑ When, on the data sheet, it is considered connection in YY or ΔΔ and the motor is connected in ΔΔ:

$$P0409 = \frac{R_s}{3}$$

$$P0411 = \frac{\sigma I_s}{3}$$

☑ When, on the data sheet, it is considered connection in YY or ΔΔ and the motor is connected in Δ:

$$P0409 = \frac{4 \times R_s}{3}$$

$$P0411 = \frac{4 \times \sigma I_s}{3}$$

☑ When, on the data sheet, it is considered connection in Δ and the motor is connected in YY:

$$P0409 = \frac{R_s}{4}$$

$$P0411 = \frac{\sigma I_s}{4}$$

☑ When, on the data sheet, it is considered connection in Δ and the motor is connected in ΔΔ:

$$P0409 = \frac{R_s}{12}$$

$$P0411 = \frac{\sigma I_s}{12}$$

☑ When, on the data sheet, it is considered connection in Δ and the motor is connected in Δ:

$$P0409 = \frac{R_s}{3}$$

$$P0411 = \frac{\sigma I_s}{3}$$

Regardless of the connection type used on the motor and of the connection type indicated on the data sheet, parameters P0410 and P0412 are defined as:

$$P0410 = I_m$$

$$P0412 = T_r$$

For conditions not included above, contact WEG.

11.8 VECTOR CONTROL [29]

11.8.1 Speed Regulator [90]

The parameters related to the CFW-11 speed regulator are presented in this group.

P0160 – Speed Regulator Configuration

Adjustable Range:	0 = Normal 1 = Saturated	Factory Setting:	0
Properties:	CFG, PM and Vector		
Access groups via HMI:	<div style="border: 1px solid black; padding: 2px; margin-bottom: 2px;">01 PARAMETER GROUPS</div> <div style="border: 1px solid black; padding: 2px; margin-bottom: 2px; margin-left: 20px;">29 Vector Control</div> <div style="border: 1px solid black; padding: 2px; margin-left: 40px;">90 Speed Regulator</div>		

Description:

Adjust P0160 = 1 in applications where stable torque is desired, as in a material winding process; in those cases, the speed reference is always maintained greater than the speed feedback value, aiming at saturating the speed regulator, that is, keeping its output equal to the value adjusted in P0169 or P0170 during the process.

If it is used for speed control F022 may occur, even if the DC link voltage regulation is active (P0185 < default value).

P0161 – Speed Regulator Proportional Gain

Adjustable Range:	0.0 to 63.9	Factory Setting:	7.0
--------------------------	-------------	-------------------------	-----

P0162 – Speed Regulator Integral Gain

Adjustable Range:	0.000 to 9.999	Factory Setting:	0.005
Properties:	PM and Vector		
Access groups via HMI:	<div style="border: 1px solid black; padding: 2px; margin-bottom: 2px;">01 PARAMETER GROUPS</div> <div style="border: 1px solid black; padding: 2px; margin-left: 20px;">29 Vector Control</div> <div style="border: 1px solid black; padding: 2px; margin-left: 40px;">90 Speed Regulator</div>		

Description:

The speed regulator gains are calculated automatically in function of the parameter P0413 (T_m constant). When P0413 is changed, parameters P0161 and P0162 are proportionally changed.

However, these gains can be adjusted manually in order to optimize the speed dynamic response.

The Proportional gain (P0161) stabilizes abrupt speed or reference changes, while the Integral gain (P0162) corrects the error between the reference and the speed, and improves the torque response at low speeds as well.

Procedure for Manual Optimization of the Speed Regulator:

1. Select the acceleration (P0100) and/or deceleration (P0101) time according to the application.
2. Adjust the speed reference for 75 % of the maximum value.
3. Configure an analog output (AOx) for Real Speed, by programming P0251, P0254, P0257 or P0260 in 2.
4. Disable the speed ramp (Run/Stop = Stop) and wait until the motor stops.
5. Enable the speed ramp (Run/Stop = Run). Observe with an oscilloscope the motor speed signal at the chosen analog output.
6. Verify among the options of the [Figure 11.4 on page 11-18](#), which waveform best represents the observed signal.

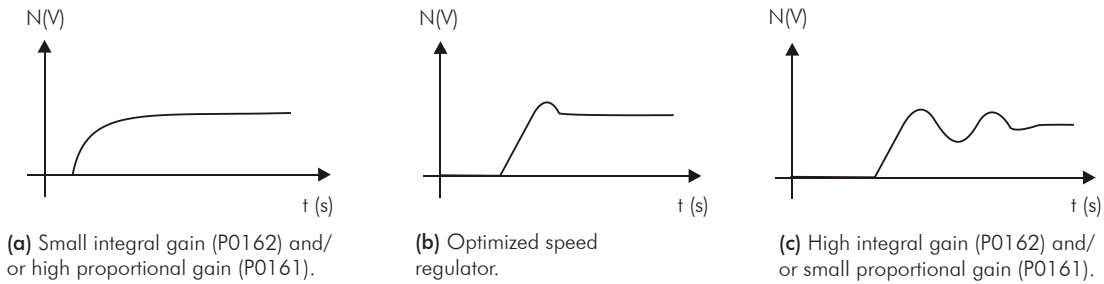

Figure 11.4 - Speed regulators response types

7. Adjust P0161 and P0162 according to the response type presented in the [Figure 11.4 on page 11-18](#).

- a) Reduce the proportional gain (P0161) and/or increase the integral gain (P0162).
- b) Speed regulator is optimized.
- c) Increase the proportional gain and/or reduce the integral gain.

In the sensorless vector control mode, the maximum typical values for proportional gain P0161 must not be greater than 9.0. If that happens, strange behaviors of the motor may be observed, such as: motor remains still or turns at low speed, although the output current is different from zero. It is recommended to reduce the value adjusted in P0161 until the motor behavior is correct.

P0163 – Local Reference Offset

P0164 – Remote Reference Offset

Adjustable Range:	-999 to 999	Factory Setting:	0
Properties:	PM and Vector		
Access groups via HMI:	<div style="border: 1px solid black; padding: 2px; margin-bottom: 2px;">01 PARAMETER GROUPS</div> <div style="border: 1px solid black; padding: 2px; margin-bottom: 2px; margin-left: 20px;">29 Vector Control</div> <div style="border: 1px solid black; padding: 2px; margin-left: 40px;">90 Speed Regulator</div>		

Description:

An offset of the analog input Alx may be occasionally adjusted. The value 999 is equivalent to a value of 0.1219 pu. Refer to the [Figure 13.10 on page 13-37](#).

P0165 – Speed Filter

Adjustable Range:	0.012 to 1.000 s	Factory Setting:	0.012 s
Properties:	PM and Vector		
Access groups via HMI:	<div style="border: 1px solid black; padding: 2px; margin-bottom: 2px;">01 PARAMETER GROUPS</div> <div style="border: 1px solid black; padding: 2px; margin-bottom: 2px; margin-left: 20px;">29 Vector Control</div> <div style="border: 1px solid black; padding: 2px; margin-left: 40px;">90 Speed Regulator</div>		

Description:

It sets the time constant of the motor speed filter either measured by the encoder when P0202 = 4, or estimated when P0202 = 3. Refer to the [Figure 11.1 on page 11-2](#) or [Figure 11.2 on page 11-4](#).

NOTE!
Generally, this parameter must not be changed. The increment in its value turns the system response slower.

P0166 – Speed Regulator Differential Gain

Adjustable Range:	0.00 to 7.99	Factory Setting:	0.00
Properties:	PM and Vector		
Access groups via HMI:	<div style="border: 1px solid black; padding: 2px; margin-bottom: 2px;">01 PARAMETER GROUPS</div> <div style="border: 1px solid black; padding: 2px; margin-left: 20px;">29 Vector Control</div> <div style="border: 1px solid black; padding: 2px; margin-left: 40px;">90 Speed Regulator</div>		

Description:

The differential action helps minimize the motor speed variations generated by sudden load changes. Refer to the [Figure 11.1 on page 11-2](#) or [Figure 11.2 on page 11-4](#).

Table 11.3 - Differential gain action in the speed regulator

P0166	Differential gain actuation
0.00	Inactive
0.01 to 7.99	Active

11.8.2 Current Regulator [91]

The parameters related to the CFW-11 current regulator are presented in this group.

P0167 – Current Regulator Proportional Gain

Adjustable Range:	0.00 to 1.99	Factory Setting:	0.50
--------------------------	--------------	-------------------------	------

P0168 – Current Regulator Integral Gain

Adjustable Range:	0.000 to 1.999	Factory Setting:	0.010
Properties:	Vector		
Access groups via HMI:	<div style="border: 1px solid black; padding: 2px; margin-bottom: 2px;">01 PARAMETER GROUPS</div> <div style="border: 1px solid black; padding: 2px; margin-bottom: 2px; margin-left: 20px;">29 Vector Control</div> <div style="border: 1px solid black; padding: 2px; margin-left: 40px;">91 Current Regulator</div>		

Description:

Parameters P0167 and P0168 are adjusted automatically as a function of the parameters P0411 and P0409, respectively.



NOTE!

Normally, those parameters do not require further adjustment. However, when the P0296 setting is higher than the P0400 setting, or when the bus DC voltage is controlled by an AFE (Active Front End), then current instability may occur.

11.8.3 Flux Regulator [92]

The parameters related to the CFW-11 flux regulator are presented next.

P0175 – Flux Regulator Proportional Gain

Adjustable Range:	0.0 to 31.9	Factory Setting:	2.0
--------------------------	-------------	-------------------------	-----

P0176 – Flux Regulator Integral Gain

Adjustable Range:	0.000 to 9.999	Factory Setting:	0.020
Properties:	Vector		
Access groups via HMI:	<div style="border: 1px solid black; padding: 2px; margin-bottom: 2px;">01 PARAMETER GROUPS</div> <div style="border: 1px solid black; padding: 2px; margin-left: 20px;">29 Vector Control</div> <div style="border: 1px solid black; padding: 2px; margin-left: 40px;">92 Flux Regulator</div>		

Description:

These parameters are adjusted automatically in function of the parameter P0412. In general, the automatic setting is sufficient and the readjustment is not necessary.

These gains must only be readjusted manually when the flux current signal (I_d^*) is unstable (oscillating) and compromising the system operation.



NOTE!

For gains in $P0175 > 12.0$ the flux current (I_d^*) may become unstable.

Note:

(I_d^*) is observed at the analog outputs AO3 and/or AO4, by setting $P0257 = 22$ and/or $P0260 = 22$.

P0177 – Minimum Flux

Adjustable Range:	0 to 120 %	Factory Setting:	30 %
Properties:	Sless		
Access groups via HMI:	<div style="border: 1px solid black; padding: 2px; margin-bottom: 2px;">01 PARAMETER GROUPS</div> <div style="border: 1px solid black; padding: 2px; margin-bottom: 2px; margin-left: 20px;">29 Vector Control</div> <div style="border: 1px solid black; padding: 2px; margin-left: 40px;">92 Flux Regulator</div>		

Description:

Minimum current value at the regulator output for sensorless control.



NOTE! The P0177 parameter value is ignored when the energy saving function is enabled.

P0178 – Rated Flux

Adjustable Range:	0 to 120 %	Factory Setting:	100 %
--------------------------	------------	-------------------------	-------

Description:

The parameter P0178 is the flux reference.



NOTE! This parameter must not be changed.

P0181 – Magnetization Mode

Adjustable Range:	0 = General Enable 1 = Run/Stop	Factory Setting:	0
Properties:	CFG and Encoder		
Access groups via HMI:	<div style="border: 1px solid black; padding: 2px; margin-bottom: 2px;">01 PARAMETER GROUPS</div> <div style="border: 1px solid black; padding: 2px; margin-bottom: 2px; margin-left: 20px;">29 Vector Control</div> <div style="border: 1px solid black; padding: 2px; margin-left: 40px;">92 Flux Regulator</div>		

Description:

Table 11.4 - Magnetization Mode

P0181	Action
0 = General Enable	Applies magnetizing current after General Enabling = ON
1 = Run/Stop	Applies magnetizing current after Run/Stop = Run

In the sensorless vector control mode, the magnetizing current is permanently active. In order to disable it when the motor is stopped, a digital input programmed for General Enabling can be used. There is also the possibility of programming P0217 in 1 (active). Refer to the [Section 12.6 ZERO SPEED LOGIC \[35\] on page 12-10](#). Besides this, a delay for disabling the magnetizing current can be set by programming P0219 bigger than zero.

P0188 – Proportional Gain of the Maximum Output Voltage Regulator

P0189 – Integral Gain of the Maximum Output Voltage Regulator

Adjustable Range:	0.000 to 7.999	Factory Setting:	P0188 = 0.200 P0189 = 0.001
Properties:	Vector		
Access groups via HMI:	<div style="border: 1px solid black; padding: 2px; margin-bottom: 2px;">01 PARAMETER GROUPS</div> <div style="border: 1px solid black; padding: 2px; margin-left: 20px; margin-bottom: 2px;">29 Vector Control</div> <div style="border: 1px solid black; padding: 2px; margin-left: 40px;">92 Flux Regulator</div>		

Description:

These parameters adjust the maximum output voltage regulator gains. In general the factory setting is adequate for the majority of the applications. Refer to the [Figure 11.1 on page 11-2](#) or [Figure 11.2 on page 11-4](#).

P0190 – Maximum Output Voltage

Adjustable Range:	0 to 690 V	Factory Setting:	P0296. Automatic setting during the Oriented Start-up Routine: P0400.
Properties:	PM and Vector		
Access groups via HMI:	<div style="border: 1px solid black; padding: 2px; margin-bottom: 2px;">01 PARAMETER GROUPS</div> <div style="border: 1px solid black; padding: 2px; margin-left: 20px; margin-bottom: 2px;">29 Vector Control</div> <div style="border: 1px solid black; padding: 2px; margin-left: 40px;">92 Flux Regulator</div>		

Description:

This parameter defines the value of the maximum output voltage. Its standard value is defined in the condition of the nominal supply voltage.

The voltage reference used in the regulator "Maximum output voltage" (see the [Figure 11.1 on page 11-2](#) or [Figure 11.2 on page 11-4](#)) is directly proportional to the voltage supply.

If this voltage increases, the output voltage will then be able to increase to the adjusted value in the parameter P0400 - Nominal Motor Voltage.

If the voltage supply decreases, the maximum output voltage will decrease in the same proportion.

11.8.4 I/f Control [93]

P0180 - I_q^* After the I/f

Adjustable Range:	0 to 350 %	Factory Setting:	10 %
Properties:	Sless		
Access groups via HMI:	<div style="border: 1px solid black; padding: 2px; margin-bottom: 2px;">01 PARAMETER GROUPS</div> <div style="border: 1px solid black; padding: 2px; margin-bottom: 2px; margin-left: 20px;">29 Vector Control</div> <div style="border: 1px solid black; padding: 2px; margin-left: 40px;">93 Control I/f</div>		

Description:

It allows setting an offset in the torque current reference variable (I_q^*) of the speed regulator in the first execution of this regulator after the transition from I/f mode to sensorless vector.

P0182 – Speed for I/f Control Actuation

Adjustable Range:	0 to 300 rpm	Factory Setting:	18 rpm
Properties:	Sless		
Access groups via HMI:	<div style="border: 1px solid black; padding: 2px; margin-bottom: 2px;">01 PARAMETER GROUPS</div> <div style="border: 1px solid black; padding: 2px; margin-left: 20px;">29 Vector Control</div> <div style="border: 1px solid black; padding: 2px; margin-left: 40px;">93 I/F Control</div>		

Description:

It defines the speed of the transition from I/f mode to the sensorless vector control and vice-versa.

The minimum recommended speed for the operation of the sensorless vector control is 18 rpm for motors with rated frequency of 60 Hz and 4 poles and 15 rpm for motors with 4 poles with rated frequency of 50 Hz.



NOTE!

For $P0182 \leq 3$ rpm the I/f function will be disabled and the inverter will remain always in the sensorless vector mode.

P0183 – Current in the I/f Mode

Adjustable Range:	0 to 9	Factory Setting:	1
Properties:	Sless		
Access groups via HMI:	<div style="border: 1px solid black; padding: 2px; margin-bottom: 2px;">01 PARAMETER GROUPS</div> <div style="border: 1px solid black; padding: 2px; margin-left: 20px;">29 Vector Control</div> <div style="border: 1px solid black; padding: 2px; margin-left: 40px;">93 I/F Control</div>		

Description:

It defines the current to be applied to the motor when the inverter is operating in the I/f mode, i.e., with the motor speed below the value defined by P0182.

Table 11.5 - Current applied in the I/f mode

P0183	Current in the I/f mode as a percentage of P0410 (I_m)
0	100 %
1	120 %
2	140 %
3	160 %
4	180 %
5	200 %
6	220 %
7	240 %
8	260 %
9	280 %

11.8.5 Self-Tuning [05] and [94]

In that group are the parameters that are related to the motor and can be estimated by the inverter during the self-tuning routine.

P0408 – Run Self-Tuning

Adjustable Range:	0 = No 1 = No Rotation 2 = Run for I_m 3 = Run for T_m 4 = Estimate T_m	Factory Setting: 0
Properties:	CFG, Vector and VVW	
Access groups via HMI:	<div style="display: flex; align-items: center; gap: 20px;"> <div style="border: 1px solid black; padding: 2px;">01 PARAMETER GROUPS</div> <div style="border: 1px solid black; padding: 2px;">05 SELF-TUNING</div> </div> <div style="margin-left: 20px;"> <div style="border: 1px solid black; padding: 2px; margin-left: 20px;">29 Vector Control</div> <div style="border: 1px solid black; padding: 2px; margin-left: 20px;">94 Self-tuning</div> </div> <div style="margin-left: 20px;">or</div>	

11



NOTE!

The commands via communication network, SoftPLC and PLC11 remain inactive during the self-tuning.

Description:

By changing from the factory setting to one of the 4 available options, it is possible to estimate the value of the parameters related to the motor being used. Refer to the next description for more details on each option.

Table 11.6 - Self-tuning options

P0408	Self-tuning	Control Type	Estimate Parameters
0	No	-	-
1	No Rotation	Sensorless vector, with encoder or VVW	P0409, P0410, P0411, P0412 and P0413
2	Run for I_m	Sensorless vector or with encoder	
3	Run for T_m	Vector with encoder	
4	Estimate T_m	Vector with encoder	P0413

P0408 = 1 – No rotation: The motor stands still during the self-tuning. The P0410 value is obtained from a table, valid for WEG motors up to 12 poles.



NOTE!

Therefore P0410 must be equal to zero before initiating the self-tuning. If $P0410 \neq 0$, the self-tuning routine will keep the existent value.

Note: When using another brand of motor P0410 must be adjusted with the adequate value (no load motor current) before initiating the self-tuning.

P0408 = 2 Run for I_m : The P0410 value is estimated with the motor rotating. It must be executed without load coupled to the motor. P0409, P0411 to P0413 are estimated with the motor standing still.



ATTENTION!

If the option P0408 = 2 (Run for I_m) is performed with the load coupled to the motor, an incorrect value of P0410 (I_m) may be estimated. This will implicate in estimation error for P0412 (rotor time constant - T_r) and for P0413 (mechanic time constant - T_m). Overcurrent fault (F071) may also occur during the inverter operation.

Note: The term "load" includes everything that might be coupled to the motor shaft, for instance, gearbox, inertia disk, etc.

P0408 = 3 Run for T_m : The value of P0413 (Mechanic time constant - T_m) is estimated, with the motor rotating. It must be done, preferably, with the load coupled to the motor. P0409 to P0412 are estimated with the motor standing still and P0410 is estimated in the same manner as with P0408 = 1.

P0408 = 4 - Estimate T_m : it estimates only the P0413 (Mechanic time constant - T_m) value, with the motor rotating. It must be done, preferably, with the load coupled to the motor.



NOTE!

- ☑ Every time that P0408 = 1 or 2:
The parameter P0413 (Mechanic time constant - T_m) will be adjusted to a value close to the motor mechanic time constant. Therefore, the motor rotor inertia (table data valid for WEG motors), the inverter rated voltage and current are taken into consideration.
- ☑ Vector mode with encoder (P0202 = 4):
When using P0408 = 2 (Run for I_m), one must, after finishing the self-tuning routine, couple the load to the motor and set P0408 = 4 (Estimate T_m) in order to estimate the value of P0413. In this case P0413 will also consider the driven load.
- ☑ VVW mode - Voltage Vector WEG (P0202 = 5):
In the VVW control self-tuning routine only the value of the stator resistance (P0409) will be obtained. Therefore, the self-tuning will always be performed without rotating the motor.
- ☑ Better self-tuning results are obtained with the motor warm.

P0409 – Motor Stator Resistance (R_s)

Adjustable Range:	0.000 to 9.999 ohm	Factory Setting:	0.000 ohm
Properties:	CFG, Vector and VVW		
Access groups via HMI:	01 PARAMETER GROUPS 29 Vector Control 94 Self-tuning	or	05 SELF-TUNING

Description:

Estimated value and automatically adjusted by the self-tuning (Section 11.3 SELF-TUNING on page 11-5). This parameter can also be obtained on the motor data sheet (Item 11.7.1 Adjustment of the Parameters P0409 to P0412 Based on the Motor Data Sheet on page 11-15).



NOTE!

The P0409 setting determines the value of the current regulator integral gain P0168. The parameter P0168 is recalculated every time the content of P0409 is modified via keypad (HMI).

P0410 – Motor Magnetizing Current (I_m)

Adjustable Range:	0 to $1.25 \times I_{nom-ND}$	Factory Setting:	I_{nom-ND}
Properties:	V/f, VVW and Vector		
Access groups via HMI:	01 PARAMETER GROUPS 29 Vector Control 94 Self-tuning	or	05 SELF-TUNING

11

Description:

It is the motor magnetizing current value, which is automatically adjusted by the self-tuning (Section 11.3 SELF-TUNING on page 11-5). Its value can also be obtained on the motor data sheet (Item 11.7.1 Adjustment of the Parameters P0409 to P0412 Based on the Motor Data Sheet on page 11-15).

It can be estimated by the self-tuning routine when $P0408 = 2$ (Run for I_m) or obtained from an internal table based in standard WEG motors, when $P0408 = 1$ (No rotation).

When a standard WEG motor is not used and it is not possible to run the self-tuning with $P0408 = 2$ (Run for I_m), then adjust P0410 with a value equal to the motor no load current, before initiating the self-tuning.

For $P0202 = 4$ (vector mode with encoder), the value P0410 determines the motor flux, therefore it must be properly adjusted. If it is low, the motor will operate with a reduced flux compared to the rated condition, having, consequently, its torque capability reduced.

P0411 – Motor Flux Leakage Inductance (σ ls)

Adjustable Range:	0.00 to 99.99 mH	Factory Setting:	0.00 mH
Properties:	CFG and Vector		
Access groups via HMI:	01 PARAMETER GROUPS 29 Vector Control 94 Self-tuning	or	05 SELF-TUNING

Description:

The value is automatically adjusted by the self-tuning (Section 11.3 SELF-TUNING on page 11-5). This parameter can also be calculated from the motor data sheet (Item 11.7.1 Adjustment of the Parameters P0409 to P0412 Based on the Motor Data Sheet on page 11-15).

**NOTE!**

When adjusted via the keypad (HMI), this parameter will change the parameter P0167 automatically.

P0412 – Lr/Rr Constant (Rotor Time Constant – T_r)

Adjustable Range:	0.000 to 9.999 s	Factory Setting:	0.000 s
Properties:	Vector		
Access groups via HMI:	01 PARAMETER GROUPS 29 Vector Control 94 Self-tuning	or	05 SELF-TUNING

Description:

This parameter is automatically adjusted during the self-tuning.

This parameter can also be calculated from the motor data sheet (Item 11.7.1 Adjustment of the Parameters P0409 to P0412 Based on the Motor Data Sheet on page 11-15).

The P0412 setting determines the flux regulator gains (P0175 and P0176).

The value of this parameter interferes in the speed accuracy in the sensorless vector control. It may also affect the motor torque on the vector with encoder.

Normally the self-tuning is performed with the motor cold. Depending on the motor, the P0412 value may vary more or less with the motor temperature. Thus, for the sensorless vector control and normal operation with the motor warm, P0412 must be adjusted until the speed of the motor with load (measured at the motor shaft with a tachometer) stays equal to that one indicated on the keypad (HMI) (P0001).

This adjustment must be performed with half the rated speed.

For P0202 = 4 (vector with encoder), if P0412 is incorrect, the motor will loose torque. Thus, one must adjust P0412 so that at half the rated speed, and with stable load, the motor current (P0003) stays the lowest possible.

In the sensorless vector control mode the P0175 gain, provided by the self-tuning, will be limited in the range: $3.0 \leq P0175 \leq 8.0$.

Table 11.7 - Typical rotor constant (T_r) values for WEG motors

Motor Power (hp) / (kW)	T_r (s)			
	Number of Poles			
	2 (50 Hz/60 Hz)	4 (50 Hz/60 Hz)	6 (50 Hz/60 Hz)	8 (50 Hz/60 Hz)
2 / 1.5	0.19 / 0.14	0.13 / 0.14	0.1 / 0.1	0.07 / 0.07
5 / 3.7	0.29 / 0.29	0.18 / 0.12	0.14 / 0.14	0.14 / 0.11
10 / 7.5	0.36 / 0.38	0.32 / 0.25	0.21 / 0.15	0.13 / 0.14
15 / 11	0.52 / 0.36	0.30 / 0.25	0.20 / 0.22	0.28 / 0.22
20 / 15	0.49 / 0.51	0.27 / 0.29	0.38 / 0.2	0.21 / 0.24
30 / 22	0.70 / 0.55	0.37 / 0.34	0.35 / 0.37	0.37 / 0.38
50 / 37	0.9 / 0.84	0.55 / 0.54	0.62 / 0.57	0.31 / 0.32
100 / 75	1.64 / 1.08	1.32 / 0.69	0.84 / 0.64	0.70 / 0.56
150 / 110	1.33 / 1.74	1.05 / 1.01	0.71 / 0.67	0.72 / 0.67
200 / 150	1.5 / 1.92	1.0 / 0.95	1.3 / 0.65	0.8 / 1.03
300 / 220	1.5 / 2.97	1.96 / 2.97	1.33 / 1.30	0.9 / 1.0
350 / 250	1.4 / 1.8	1.86 / 1.85	1.3 / 1.53	0.9 / 1.0
500 / 375	1.36 / 1.7	1.9 / 1.87	1.2 / 1.3	0.9 / 1.0



NOTE!

When adjusted via the keypad (HMI), this parameter may change automatically the following parameters: P0175, P0176, P0327 and P0328. For motors larger than 500 CV, contact WEG.

P0413 – T_m Constant (Mechanical Time Constant)

Adjustable Range:	0.00 to 99.99 s	Factory Setting:	0.00 s
Properties:	Vector		
Access groups via HMI:	01 PARAMETER GROUPS	or	05 SELF-TUNING
	29 Vector Control		
	94 Self-tuning		

Description:

This parameter is automatically adjusted during the self-tuning. The P0413 setting determines the speed regulator gains (P0161 and P0162).

When P0408 = 1 or 2, it must be observed:

- If P0413 = 0, the time constant T_m will be obtained in function of the inertia of the programmed motor (table value).
- If P0413 > 0, the value of P0413 will not be changed by the self-tuning.

Sensorless vector control (P0202 = 3):

- When the P0413 value obtained through the self-tuning provides inadequate speed regulator gains (P0161 and P0162), it is possible to change them by setting P0413 via keypad (HMI).
- The P0161 gain provided by the self-tuning or through P0413 change, will be limited to the range: $6.0 \leq P0161 \leq 9.0$.
- The P0162 value varies in function of the P0161 value.
- In case it be necessary to increase even more these gains, they must be adjusted directly at P0161 and P0162.

Note: Values of P0161 > 12.0 may turn the torque current (I_q) and the motor speed unstable (oscillating).

Vector control with encoder (P0202 = 4):

The load may be coupled to the motor shaft for this step of the routine.
The P0413 value is estimated by the self-tuning when P0408 = 3 or 4.

The measurement procedure consists in accelerating the motor up to 50 % of the rated speed, applying a current step equal to the motor rated current.

When it is not possible to estimate P0413 using the self-tuning function (in applications of cranes, position control and others), adjust P0413 via keypad (HMI). Consult [Item 11.8.1 Speed Regulator \[90\]](#) on page 11-17.

11.8.6 Torque Current Limitation [95]

The parameters placed in this group define the torque limitation values.

P0169 – Maximum "+" Torque Current

P0170 – Maximum "-" Torque Current

Adjustable Range:	0.0 to 350.0 %	Factory Setting:	125.0 %
Properties:	PM and Vector		
Access groups via HMI:	<div style="border: 1px solid black; padding: 2px; margin-bottom: 2px;">01 PARAMETER GROUPS</div> <div style="border: 1px solid black; padding: 2px; margin-bottom: 2px; margin-left: 20px;">29 Vector Control</div> <div style="border: 1px solid black; padding: 2px; margin-left: 40px;">95 Torque Curr.Limit</div>		

Description:

These parameters limit the motor current component that produces "+" (P0169) or "-" (P0170) torque. The adjustment is expressed as a percentage of the motor nominal torque current.

The positive torque occurs when the motor drives the load in the clockwise direction, or the load drives the motor in the counterclockwise direction. The negative torque occurs when the motor drives the load in the counterclockwise direction, or the load drives the motor in the clockwise direction.

If P0169 or P0170 is adjusted too low, there might not be enough torque for the motor to activate the load. If the value adjusted in the parameters is too high, overload or overcurrent fault may occur.

In case that any Analog Input (Alx) be programmed for the option 2 (Maximum Torque Current), P0169 and P0170 become inactive and the current limitation will be specified by the Alx. In this case the limitation value can be monitored at the parameter correspondent to the programmed Alx (P0018 ... P0021).



NOTE! The maximum value that those parameters may assume is internally limited at 1.8 x P0295 (HD).

In the torque limitation condition the motor current can be calculated by:

$$I_{non_torque} = \sqrt{P0401^2 - \left(P0410 \times \frac{P0178}{100} \right)^2} \quad \text{(Rated torque current)}$$

$$I_{motor} = \sqrt{\left(\frac{P0169 \times I_{nom_torque}}{100} \right)^2 + \left(P0410 \times \frac{P0178}{100} \right)^2}$$

The maximum torque developed by the motor is given by:

$$T_{motor} (\%) = P0169 \cdot k$$

Where the factor k is defined by:

- region of constant flux (constant torque and below or equal to the synchronous speed): $k = 1$.
 - region of field weakening (region of constant power; higher than the synchronous speed):
- $$k = (N_{sync} / P0002) \times (P0190 / P0400).$$
- Whose N_{sync} is the motor synchronous speed in RPM.

(*) In case that the current limitation be provided by an analog input, replace P0169 or P0170 by P0018, P0019, P0020 or P0021, according to the programmed AIx. For more details refer to the [Item 13.1.1 Analog Inputs \[38\] on page 13-1](#).

For the applications of torque control some recommendations of adjustments of P0169 and P0170 are provided in [Section 11.5 TORQUE CONTROL on page 11-7](#).

11.8.7 DC Link Regulator [96]

For the deceleration of high inertia loads with short deceleration times, the CFW-11 has available the DC Link Regulation function, which avoids the tripping of the inverter by overvoltage in the DC link (F022).

P0184 – DC Link Regulation Mode

Adjustable Range:	0 = With losses 1 = Without losses 2 = Enable/Disable DIx	Factory Setting: 1
Properties:	CFG, PM and Vector	
Access groups via HMI:	<div style="border: 1px solid black; padding: 2px; margin-bottom: 2px;">01 PARAMETER GROUPS</div> <div style="border: 1px solid black; padding: 2px; margin-bottom: 2px; margin-left: 20px;">29 Vector Control</div> <div style="border: 1px solid black; padding: 2px; margin-left: 40px;">96 DC Link Regulator</div>	

Description:

It enables or disables the Optimal Braking function ([Section 11.6 OPTIMAL BRAKING on page 11-8](#)) in the DC voltage regulation, according to the next table.

Table 11.8 - DC link regulation modes

P0184	Action
0 = With losses (Optimal Braking)	The Optimal Braking is active as described at P0185. This assures the minimum possible deceleration time without using dynamic or regenerative braking
1 = Without losses	Automatic control of the deceleration ramp. The Optimal Braking is inactive. The deceleration ramp is automatically adjusted in order to keep the DC link below the level adjusted in P0185. This procedure avoids the overvoltage fault at the DC link (F022). It can also be used with eccentric loads
2 = Enable/Disable via DlX	<input checked="" type="checkbox"/> DlX = 24 V: Braking actuates as described for P0184 = 1 <input checked="" type="checkbox"/> DlX = 0 V: The Without Losses Braking stays inactive. The DC link voltage will be controlled by the parameter P0153 (Dynamic Braking)

P0185 – DC Link Voltage Regulation Level

Adjustable Range:	339 to 400 V	Factory Setting:	P0296=0: 400 V
	585 to 800 V		P0296=1: 800 V
	585 to 800 V		P0296=2: 800 V
	585 to 800 V		P0296=3: 800 V
	585 to 800 V		P0296=4: 800 V
	809 to 1000 V		P0296=5: 1000 V
	809 to 1000 V		P0296=6: 1000 V
	924 to 1200 V		P0296=7: 1000 V
	924 to 1200 V		P0296=8: 1200 V
Properties:	Vector		
Access groups via HMI:	01 PARAMETER GROUPS		
	29 Vector Control		
	96 DC Link Regulator		

Description:

This parameter defines the DC link voltage regulation level during the braking. During the braking, the time of the deceleration ramp is automatically extended, thus avoiding an overvoltage fault (F022). The setting of the DC link regulation can be done in two manners:

1. With loss (optimal break) – set P0184 = 0.
 - 1.1 - P0404 < 20 (60 hp): In this way the current flux is modulated in a way to increase the losses of the motor, increasing the break torque. A better operation can be obtained with motors of smaller efficiency (small motors).
 - 1.2 - P0404 > 20 (60 hp): the current flux will be increased up to the maximum value defined on P0169 or P0170, as the speed is reduced. The break torque in the weakness field area is small.
2. Without losses – set P0184 = 1. Activates only the DC link voltage regulation.



NOTE!

The factory setting for P0185 is adjusted at the maximum, which disables the DC link voltage regulation. In order to activate it, set P0185 according to the [Table 11.9 on page 11-31](#).

Table 11.9 - DC link voltage regulation recommended levels

Inverter V _{nom}	200 ... 240 V	380 V	400 / 415 V	440 / 460 V	480 V	500 / 525 V	550 / 575 V	600 V	660 / 690 V
P0296	0	1	2	3	4	5	6	7	8
P0185	375 V	618 V	675 V	748 V	780 V	893 V	972 V	972 V	1174 V

P0186 – DC Link Voltage Regulation Proportional Gain

Adjustable Range:	0.0 to 63.9	Factory Setting:	18.0
--------------------------	-------------	-------------------------	------

P0187 – DC Link Voltage Regulation Integral Gain

Adjustable Range:	0.000 to 9.999	Factory Setting:	0.002
--------------------------	----------------	-------------------------	-------

Properties: PM and Vector

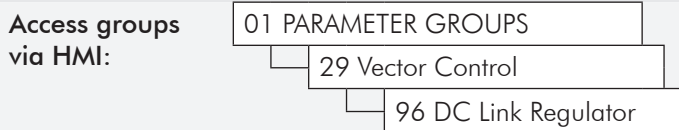

Description:

These parameters adjust the DC link voltage regulator gain.

Normally the factory settings are adequate for the majority of the applications, not being necessary to adjust them.

11.9 START-UP IN THE VECTOR MODES SENSORLESS AND WITH ENCODER



NOTE!

Read the whole CFW-11 user's manual before installing, powering or operating the inverter.

Sequence for installation, verification, powering and start-up:

- a) **Install the inverter:** according to the chapter 3 – Installation and Connection of the CFW-11 user's manual, wiring all the power and control connections.
- b) **Prepare the inverter and apply power:** according to the section 5.1 - Prepare for Start-Up, of the CFW-11 user's manual.
- c) **Adjust the password P0000 = 5:** according to the [Section 5.3 PASSWORD SETTING IN P0000 on page 5-3](#), of this manual.
- d) **Adjust the inverter to operate with the application line and motor:** by means of the "Oriented Start-up" Menu access **P0317** and change its content to 1, which makes the inverter initiate the "Oriented Start-up" routine.

The "Oriented Start-up" routine presents on the keypad (HMI) the main parameters in a logical sequence. The setting of these parameters prepares the inverter for operation with the application line and motor.

The setting of the parameters presented in this operation mode results in the automatic modification of the content of other inverter parameters and/or internal variables. In this way one gets a stable operation of the control circuit with adequate values to obtain the best motor performance.

During the "Oriented Start-up" routine the "Config" (Configuration) status will be indicated on the top left part of the keypad (HMI).

**Parameters related to the motor:**

- ☑ Program the contents of parameters from P0398, P0400 to P0406 directly with the motor nameplate data.

- ☑ Options for the setting of parameters P0409 to P0412:
 - Automatic, with the inverter executing the self-tuning routine as selected in one of the P0408 options.
 - From the motor data sheet supplied by its manufacturer. Refer to the procedure in the [Item 11.7.1 Adjustment of the Parameters P0409 to P0412 Based on the Motor Data Sheet on page 11-15](#), of this manual.
 - Manually, copying the contents of the parameters from another CFW-11 inverter, which uses and identical motor.

e) **Setting of specific parameters and functions for the application:** set the digital and analog inputs and outputs, HMI keys, etc., according to the application needs.

**For applications:**









- ☑ That are simple, which can use the factory settings programming for the digital and analog inputs and outputs, use the Menu [04] "Basic Application". Refer to the item 5.2.3 - Setting Basic Application Parameters, of the CFW-11 user's manual.

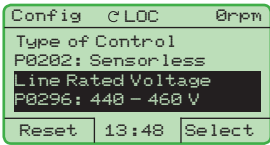

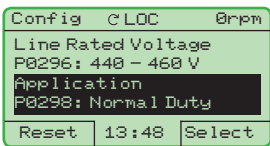

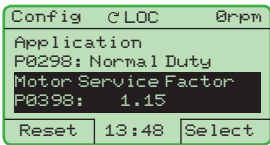

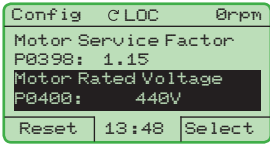

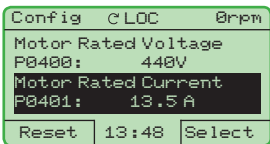
- ☑ That require only the digital and analog inputs and outputs with programming different from the factory settings, use the Menu [07] "I/O Configuration".

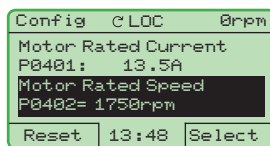
- ☑ That need functions as Flying Start, Ride-Through, DC Braking, Dynamic Braking, etc., access and modify those function parameters by means of the Menu [01] "Parameter Groups".

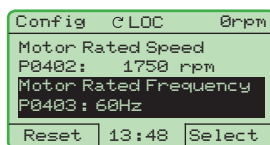
Seq.	Action/Result	Display Indication
1	- Monitoring Mode. - Press "Menu" (right "soft key").	
2	- The group "00 ALL PARAMETERS" is already selected.	
3	- The group "01 PARAMETER GROUPS" is selected.	
4	- The group "02 ORIENTED START-UP" is then selected. - Press "Select".	
5	- The parameter "Oriented Start-up P0317: No" is already selected. - Press "Select".	
6	- The content of "P0317 = [000] No" is showed.	
7	- The content of the parameter is changed to "P0317 = [001] Yes" - Press "Save".	

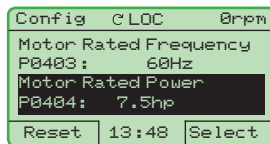
Seq.	Action/Result	Display Indication
8	- In this moment the Oriented Start-up routine is initiated and the "Config" status is indicated at the top left part of the keypad (HMI). - The parameter "Language P0201: English" is already selected. - If necessary, change the language by pressing "Select", next and to select the language and then press "Save".	
9	- Set the content of P0202 pressing "Select". - Next press until selecting the option "[003] Sensorless or [004] Encoder". This change resets the contents of P0410. Then press "Save". - Note that from this moment on the option "Reset" (left "soft key") or are no longer available. - There are 3 options to leave the Oriented Start-up: 1. Executing the Self-Tuning. 2. Setting the parameters P0409 to P0413 manually. 3. Changing P0202 from vector to scalar control.	

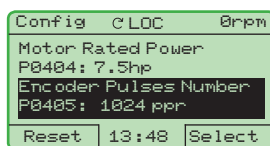
Seq.	Action/Result	Display Indication
10	- If necessary, change the content of P0296 according to the used line voltage. Therefore press "Select". This change will affect P0151, P0153, P0185, P0190, P0321, P0322, P0323 and P0400. 	
11	- If necessary, change the content of P0298 according to the inverter application. Therefore press "Select". This change may affect P0156, P0157, P0158, P0169, P0170, P0401 and P0404. The actuation time and level of the IGBTs overload protection will also be affected. 	
12	- If necessary adjust the content of P0398 according to the motor service factor. Therefore press "Select". This change will affect the current value and the time for the actuation of the motor overload function. 	
13	- If necessary, change the content of P0400 according to the rated motor voltage. Therefore press "Select". This change will affect P0190. 	
14	- If necessary, change the content of P0401 according to the rated motor current. Therefore press "Select". This change will affect P0156, P0157 and P0158. 	

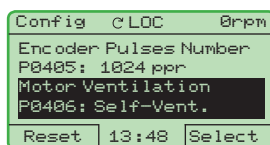
Seq.	Action/Result	Display Indication
15	- If necessary, change the content of P0402 according to the rated motor speed. Therefore press "Select". This change may affect P0122 to P0131, P0133, P0134, P0182, P0208, P0288 and P0289. 	
16	- If necessary, change the content of P0403 according to the rated motor frequency. Therefore press "Select". 	
17	- If necessary, change the content of P0404 according to the rated motor power. Therefore press "Select". 	
18	- This parameter will only be visible if the encoder board ENC1, ENC2 or PLC11 module is connected to the inverter. - If there is an encoder connected to the motor, change P0405 according to its number of pulses per revolution. Therefore press "Select". 	
19	- If necessary, change the content of P0406 according to the type of motor ventilation. Therefore press "Select". This change will affect P0156, P0157, P0158, P0399 and P0407. 	

Seq.	Action/Result	Display Indication
20	<p>At this point, the keypad (HMI) presents the option to run the "Self-Tuning". Whenever possible the Self-Tuning must be carried out.</p> <p>- Thus, press "Select" to access P0408 and then  to select the desired option. Refer to the Item 11.8.5 Self-Tuning [05] and [94] on page 11-24, for more details.</p> <p>- Next press "Save".</p>	
21	<p>- After doing that the Self-Tuning routine is initiated and "SelfTun" is indicated on the top left corner of the keypad (HMI).</p> <p>- If the chosen option had been the option 1, 2 or 3 in P0408, the keypad (HMI) will present "P0409: Estimating Rs".</p>	
22	<p>The keypad (HMI) will also indicate the estimation of the parameters P0411, P0410 and P0412 (if the option 1, 2 or 3 had been chosen in P0408).</p> <p>- When P0408 = 1 or 3 the keypad (HMI) will not indicate the P0410 estimation.</p> <p>- When P0408 = 3 or 4 the keypad (HMI) will indicate the P0413 estimation.</p> <p>- Wait until the end of the Self-Tuning routine.</p>	   
23	<p>Once the Self-Tuning routine has finished, the inverter returns to the monitoring mode.</p>	

Figure 11.5 - Vector mode Oriented Start-up

12 FUNCTIONS COMMON TO ALL THE CONTROL MODES

This section describes the functions that are common to all the CFW-11 inverter control modes (V/f, VVV, Sensorless, and Encoder).

12.1 RAMPS [20]

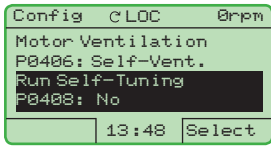
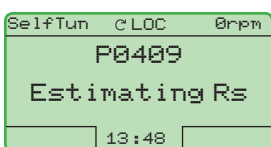
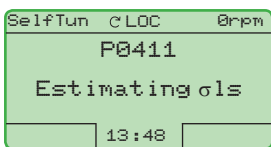
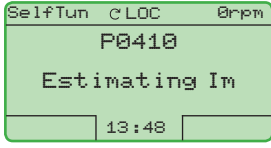
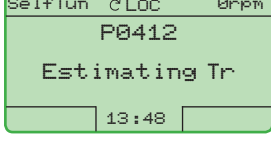
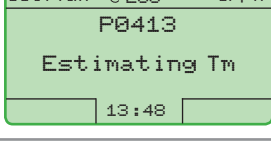
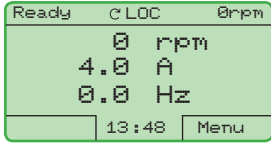
The inverter RAMPS functions allow the motor to accelerate and decelerate in a faster or a slower manner.

P0100 – Acceleration Time

P0101 – Deceleration Time

Adjustable Range:	0.0 to 999.0 s	Factory Setting:	20.0 s
Properties:			
Access groups via HMI:	<div style="border: 1px solid black; padding: 2px; display: inline-block;">01 PARAMETER GROUPS</div> <div style="border: 1px solid black; padding: 2px; display: inline-block; margin-left: 20px;">20 Ramps</div>		

Description:

These parameters define the time to accelerate (P0100) linearly from 0 to the maximum speed (defined in P0134) and decelerate (P0101) linearly from the maximum speed down to 0.

Note: The setting 0.0 s means that the ramp is disabled.

P0102 – Acceleration Time 2

P0103 – Deceleration Time 2

Adjustable Range:	0.0 to 999.0 s	Factory Setting:	20.0 s
Properties:			
Access groups via HMI:	<div style="border: 1px solid black; padding: 2px; display: inline-block;">01 PARAMETER GROUPS</div> <div style="border: 1px solid black; padding: 2px; display: inline-block; margin-left: 20px;">20 Ramps</div>		

Description:

Those parameters allow a second ramp to be configured for the motor acceleration (P0102) or deceleration (P0103), which is activated via an external digital command (defined by P0105). Once this command is activated, the inverter ignores the times of the first ramp (P0100 or P0101) and starts obeying the value adjusted at the second ramp (Refer the example for external command via DIx showed next in the [Figure 12.1 on page 12-2](#)).

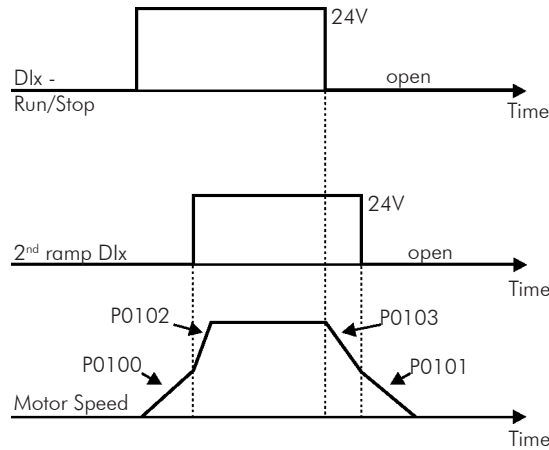

Figure 12.1 - Second ramp actuation

In this example, the commutation to the 2nd ramp (P0102 or P0103) is done by means of one of the digital inputs from DI1 to DI8, provided that it had been programmed for 2nd ramp function (refer to the [Item 13.1.3 Digital Inputs \[40\]](#) on page 13-12, for more details).

Note: The setting 0.0 s means that the ramp is disabled.

P0104 – S Ramp

Adjustable Range:	0 = Off 1 = 50 % 2 = 100 %	Factory Setting: 0
Properties:		
Access groups via HMI:	01 PARAMETER GROUPS 20 Ramps	

Description:

This parameter allows that the acceleration and deceleration ramps have a nonlinear profile, similar to an "S", as showed in the [Figure 12.2 on page 12-2](#) next.

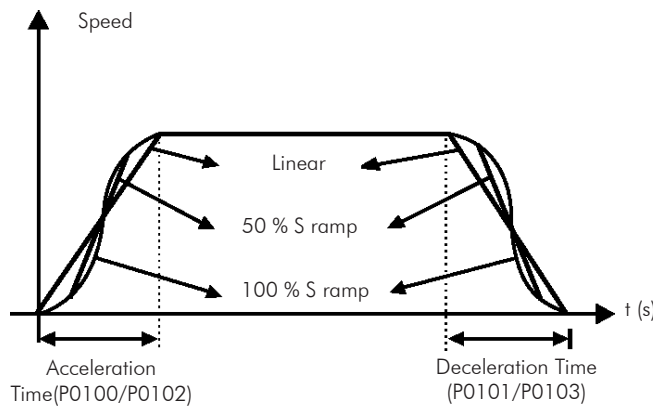

Figure 12.2 - S or linear ramp

The S ramp reduces mechanic shock during accelerations/decelerations.

P0105 – 1st/2nd Ramp Selection

Adjustable Range:	0 = 1 st Ramp 1 = 2 nd Ramp 2 = DIx 3 = Serial/USB 4 = Anybus-CC 5 = CANopen/DeviceNet/Profibus DP 6 = SoftPLC 7 = PLC11	Factory Setting: 2
Properties:	CFG	
Access groups via HMI:	01 PARAMETER GROUPS 20 Ramps	

Description:

It defines the source of the command that will select between the Ramp 1 and the Ramp 2.

Notes:

- "Ramp 1" means that the acceleration and deceleration ramps are following the values programmed in P0100 and P0101.
- "Ramp 2" means that the acceleration and deceleration ramps are following the values programmed in P0102 and P0103.
- It is possible to monitor the set of ramps being used in a defined moment at the parameter P0680 (Logical status).

12.2 SPEED REFERENCES [21]

This parameter group makes it possible that the reference values for the motor speed and for the functions JOG, JOG+ and JOG- be established. It is also possible to define if the reference value will be kept when the inverter is switched off or disabled. For more details refer to the [Figure 13.10 on page 13-37](#) and [Figure 13.11 on page 13-38](#).

P0120 – Speed Reference Backup

Adjustable Range:	0 = Off 1 = On	Factory Setting: 1
Properties:		
Access groups via HMI:	01 PARAMETER GROUPS 21 Speed References	

Description:

This parameter defines if the speed reference backup function is active or inactive.

If P0120 = Off, inactive, then the inverter will not save the speed reference when it is disabled. Thus, when the inverter is enabled again the speed reference will assume the value of the minimum speed limit (P0133).

This backup function applies to the references via keypad (HMI), E.P., Serial/USB, Anybus-CC, CANopen/DeviceNet, and PID Setpoint.

P0121 – Keypad Reference

Adjustable Range:	0 to 18000 rpm	Factory Setting:	90 rpm
Properties:			
Access groups via HMI:	01 PARAMETER GROUPS		
	21 Speed References		

Description:

When the ▲ and ▼ HMI keys are active (P0221 or P0222 = 0), this parameter sets the value of the motor speed reference.

The value of P0121 will be kept with the last adjusted value when the inverter is disabled or powered off, provided that the parameter P0120 is configured as Active (1). In this case, the value of P0121 is recorded on the EEPROM when the condition of undervoltage on the DC Link is detected.

P0122 – JOG Speed Reference

Adjustable Range:	0 to 18000 rpm	Factory Setting:	150 rpm (125 rpm)
Properties:			
Access groups via HMI:	01 PARAMETER GROUPS		
	21 Speed References		

Description:

During the JOG command the motor accelerates up to the value defined in P0122 following the adjusted acceleration ramp.

The source of the JOG command is defined in the parameters P0225 (Local Situation) or P0228 (Remote Situation).

If the JOG command source has been defined for the digital inputs (DI1 to DI8), one of these inputs must be programmed as presented in the [Table 12.1 on page 12-4](#).

Table 12.1 - JOG command via digital input selection

Digital Input	Parameters
DI1	P0263 = 10 (JOG)
DI2	P0264 = 10 (JOG)
DI3	P0265 = 10 (JOG)
DI4	P0266 = 10 (JOG)
DI5	P0267 = 10 (JOG)
DI6	P0268 = 10 (JOG)
DI7	P0269 = 10 (JOG)
DI8	P0270 = 10 (JOG)

For more details refer to the [Figure 13.6 on page 13-19 \(h\)](#).

The speed direction is defined by the parameters P0223 or P0226.

The JOG command is effective only with the motor stopped.

For the JOG+ refer to the description below.

P0122 – JOG + Speed Reference

P0123 – JOG - Speed Reference

Adjustable Range:	0 to 18000 rpm	Factory Setting:	150 rpm (125 rpm)
Properties:	PM and Vector		
Access groups via HMI:	01 PARAMETER GROUPS 21 Speed References		

Description:

The JOG+ or JOG- commands are always carried out via digital inputs.

One DIx input must be programmed for JOG+ and another for JOG- as presented in the [Table 12.2 on page 12-5](#) next:

Table 12.2 - Selection of the JOG+ and JOG- commands via digital inputs

Digital Input	Function	
	JOG+	JOG -
DI1	P0263 = 16	P0263 = 17
DI2	P0264 = 16	P0264 = 17
DI3	P0265 = 16	P0265 = 17
DI4	P0266 = 16	P0266 = 17
DI5	P0267 = 16	P0267 = 17
DI6	P0268 = 16	P0268 = 17
DI7	P0269 = 16	P0269 = 17
DI8	P0270 = 16	P0270 = 17

During the JOG+ or JOG- commands the values of P0122 and P0123 are, respectively, added or subtracted from the speed reference to generate the total reference (refer to the [Figure 13.10 on page 13-37](#)).

For the JOG option refer to the previous parameter description.

12.3 SPEED LIMITS [22]

The parameters of this group have the purpose of acting as motor speed limits.

P0132 – Maximum Overspeed Level

Adjustable Range:	0 to 100 %	Factory Setting:	10 %
Properties:	CFG		
Access groups via HMI:	01 PARAMETER GROUPS 22 Speed Limits		

Description:

This parameter sets the highest speed allowed for the motor to operate, and must be adjusted as a percentage of the maximum speed limit (P0134).

When the actual speed exceeds the value of P0134 + P0132 longer than 20 ms, the CFW-11 will disable the PWM pulses and indicate the fault (F150).

In order to disable this function, set P0132 = 100 %.

P0133 – Minimum Speed Reference Limit

Adjustable Range:	0 to 18000 rpm	Factory Setting:	90 rpm (75 rpm)
-------------------	----------------	------------------	-----------------

P0134 – Maximum Speed Reference Limit

Adjustable Range:	0 to 18000 rpm	Factory Setting:	1800 rpm (1500 rpm)
-------------------	----------------	------------------	---------------------

Properties:

Access groups via HMI:	01 PARAMETER GROUPS
	22 Speed Limits

Description:

They define the maximum/minimum values for the motor speed reference when the inverter is enabled. They are valid for any type of reference signal. For details on the actuation of P0133, refer to the parameter P0230 (Dead Zone of the Analog Inputs).



NOTE!

The maximum allowed speed is limited at the value defined by $3.4 \times P0402$. P0134 is always the reference limit of the maximum speed, even if the value configured in P0133 is greater than the value of P0134.

12

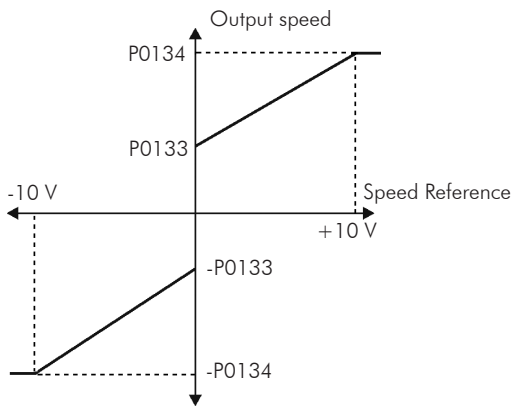

(a) - Speed limits considering the "Dead Zone" inactive (P0230 = 0)

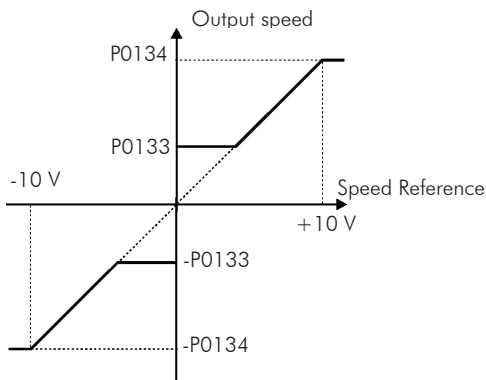
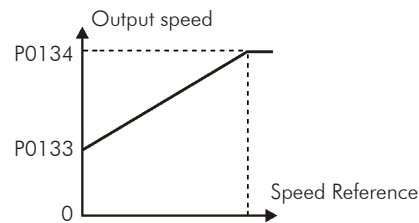

(b) - Speed limits considering the "Dead Zone" active (P0230 = 1)

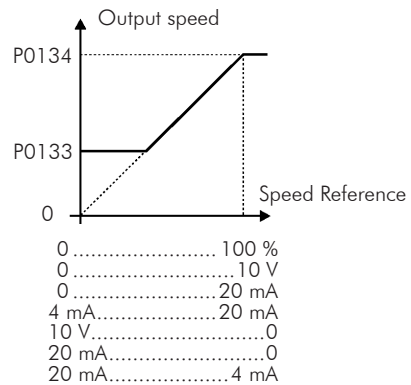

Figure 12.3 - (a) and (b) Speed limits considering the "Dead Zone" inactive (P0230 = 0) and active (P0230 = 1)

12.4 MULTISPEED [36]

The MULTISPEED function is used when one wishes to have up to 8 predefined fixed speeds, which are commanded through the digital inputs (DI4, DI5 and DI6).

P0124 – Multispeed Reference 1

Adjustable Range:	0 to 18000 rpm	Factory Setting:	90 rpm (75 rpm)
--------------------------	----------------	-------------------------	--------------------

P0125 – Multispeed Reference 2

Adjustable Range:	0 to 18000 rpm	Factory Setting:	300 rpm (250 rpm)
--------------------------	----------------	-------------------------	----------------------

P0126 – Multispeed Reference 3

Adjustable Range:	0 to 18000 rpm	Factory Setting:	600 rpm (500 rpm)
--------------------------	----------------	-------------------------	----------------------

P0127 – Multispeed Reference 4

Adjustable Range:	0 to 18000 rpm	Factory Setting:	900 rpm (750 rpm)
--------------------------	----------------	-------------------------	----------------------

P0128 – Multispeed Reference 5

Adjustable Range:	0 to 18000 rpm	Factory Setting:	1200 rpm (1000 rpm)
--------------------------	----------------	-------------------------	------------------------

P0129 – Multispeed Reference 6

Adjustable Range:	0 to 18000 rpm	Factory Setting:	1500 rpm (1250 rpm)
--------------------------	----------------	-------------------------	------------------------

P0130 – Multispeed Reference 7

Adjustable Range:	0 to 18000 rpm	Factory Setting:	1800 rpm (1500 rpm)
--------------------------	----------------	-------------------------	------------------------

P0131 – Multispeed Reference 8

Adjustable Range:	0 to 18000 rpm	Factory Setting:	1650 rpm (1375 rpm)
--------------------------	----------------	-------------------------	------------------------

Properties:

Access groups via HMI:	<table border="1" style="display: inline-table; vertical-align: middle;"> <tr> <td>01 PARAMETER GROUPS</td> </tr> <tr> <td>36 Multispeed</td> </tr> </table>	01 PARAMETER GROUPS	36 Multispeed
01 PARAMETER GROUPS			
36 Multispeed			

Functions Common to All the Control Modes

Description:

The Multispeed brings as advantages the stability of the predefined fixed references, and the immunity against electric noises (isolated digital inputs DIx).

In order to activate the Multispeed function one must configure the parameter P0221 = 8 and/or P0222 = 8 (Reference Selection).

In order to use only 2 or 4 speeds, any combination of the DI4, DI5 and DI6 inputs can be used. Verify the Speed Reference parameters according to the used DI's.

The input(s) programmed for other function(s) must be considered as 0 V, as presented in the [Table 12.4 on page 12-8](#).

Table 12.3 - Multispeed function selection via digital inputs

Enabled DIx	Programming
DI4	P0266 = 13
DI5	P0267 = 13
DI6	P0268 = 13

Table 12.4 - Multispeed reference

8 speeds			
		4 speeds	
		2 speeds	
DI6	DI5	DI4	Speed Reference
0 V	0 V	0 V	P0124
0 V	0 V	24 V	P0125
0 V	24 V	0 V	P0126
0 V	24 V	24 V	P0127
24 V	0 V	0 V	P0128
24 V	0 V	24 V	P0129
24 V	24 V	0 V	P0130
24 V	24 V	24 V	P0131

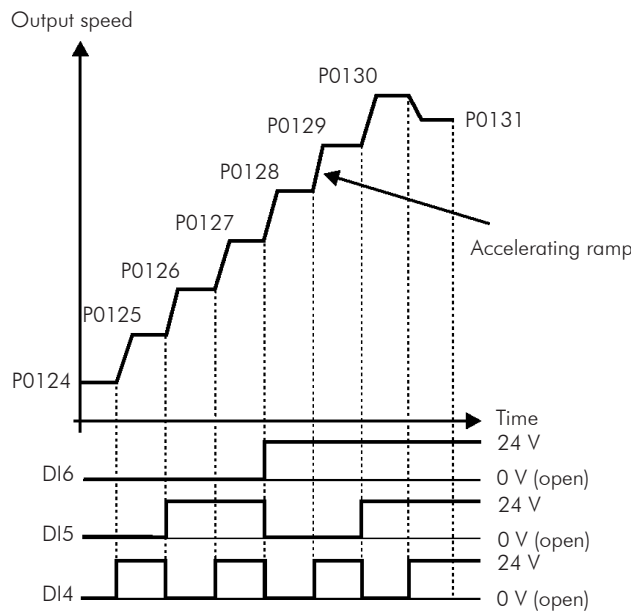

Figure 12.4 - Multispeed

12.5 ELECTRONIC POTENTIOMETER [37]

The ELECTRONIC POTENTIOMETER (E.P.) function allows that the speed reference be adjusted by means of 2 digital inputs (one for incrementing it and another for decrementing it).

In order to enable this function, the speed reference must first be configured to be via E.P., by setting P0221 = 7 and/or P0222 = 7. After this function has been enabled, it is only necessary to program two of the digital inputs (P0263 to P0270) in 11 (Increase E.P.) and 12 (Decrease E.P.).

The operation of this function can be observed in the next figure. It is important to point out that the increase of the speed reference is done with the application of 24 V at the digital inputs, whereas the decrease is done with the application of 0 V.

In order to reset the reference, 24 V must be applied at the "INCREASE" input and 0 V at the "DECREASE" input, simultaneously while the CFW-11 inverter is disabled.

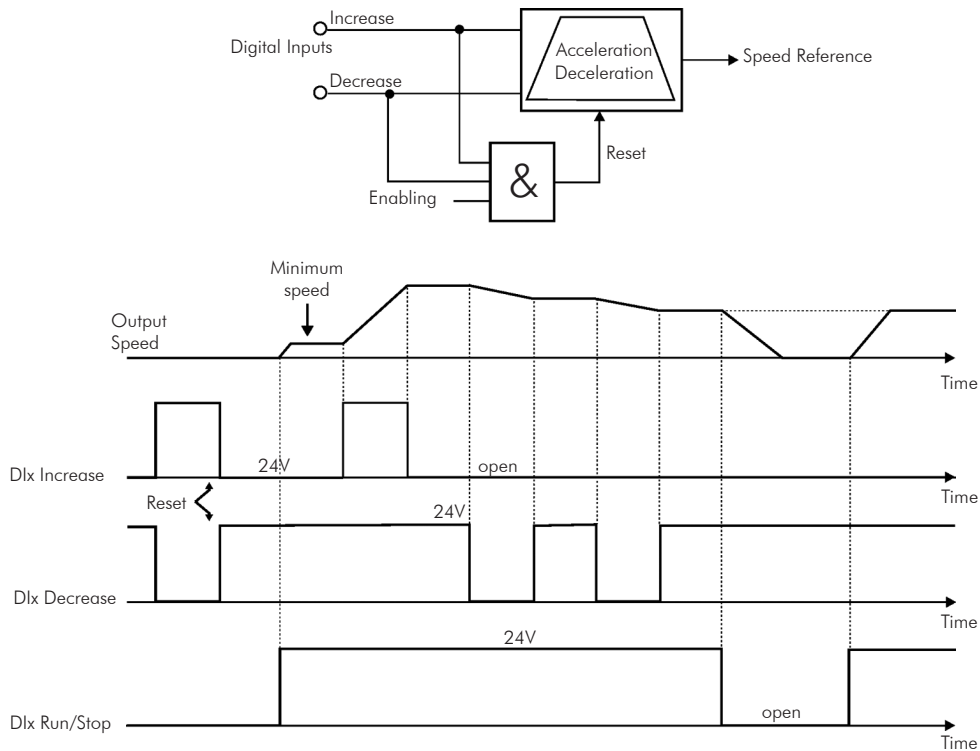

Figure 12.5 - Electronic potentiometer function (E.P.)

12.6 ZERO SPEED LOGIC [35]

This function allows the configuration of a speed in which the inverter will enter a stop condition (disable itself).

It is recommended to use this function when the commands Run/Stop, Direction of Rotation, LOC/REM and JOG are generated by the keyboard (HMI) or by the digital inputs (DIx).

P0217 – Zero Speed Disable

Adjustable Range:	0 = Off 1 = On (N* and N) 2 = On (N*)	Factory Setting: 0
Properties:	CFG	
Access groups via HMI:	01 PARAMETER GROUPS 35 Zero Speed Logic	

Description:

When on (N* and N), it disables the inverter after the speed reference (N*) and the actual speed (N) become lower than the value adjusted in the parameter P0291 ± 1 % of the motor rated speed (hysteresis).

When on (N*), it disables the inverter after the speed reference (N*) becomes lower than the value adjusted in parameter P0291 ± 1 % of the motor rated speed (hysteresis).

The inverter is enabled again when one of the conditions defined by the parameter P0218 is satisfied.



DANGER!

Be careful when approaching the motor while it is in the disable condition. It may get back to operation at any moment because of the process conditions. In case you want to handle or perform any type of maintenance, remove power from the inverter.

P0218 – Condition to Leave the Zero Speed Disable

Adjustable Range:	0 = Reference or Speed 1 = Reference	Factory Setting: 0
Properties:		
Access groups via HMI:	01 PARAMETER GROUPS 35 Zero Speed Logic	

Description:

It specifies if the condition to leave the zero speed disable will be only the speed reference or also the actual speed.

Table 12.5 - Condition to leave the N = 0 disable

P0218 (P0217 = 1)	Inverter leaves the condition of disable by N = 0
0	P0001 (N*) > P0291 or P0002 (N) > P0291
1	P0001 (N*) > P0291

When the PID regulator is active ($P0203 = 1$) and in Automatic mode, for the inverter to leave the disable condition, besides the condition programmed in P0218, it is also necessary that the PID error (the difference between the Setpoint and the process variable) be higher than the value programmed in P0535. Refer to the [Section 20.6 PARAMETERS on page 20-9](#), for more details.

P0219 – Zero Speed Time

Adjustable Range:	0 to 999 s	Factory Setting:	0 s
Properties:			
Access groups via HMI:	<div style="border: 1px solid black; padding: 2px; display: inline-block;">01 PARAMETER GROUPS</div> <div style="border: 1px solid black; padding: 2px; display: inline-block; margin-left: 20px;">35 Zero Speed Logic</div>		

Description:

It defines whether or not the Zero Speed Disable function will be timed.

If $P0219 = 0$, the function works without timing.

If $P0219 > 0$, the function will be configured with timing, and the counting of the time adjusted in this parameter will be initiated after the Speed Reference and the Actual Motor Speed become lower than the value adjusted in P0291. When the counting reaches the time defined in P0219, the inverter will be disabled. If during the time counting any of the conditions that cause the zero speed disable ceases being fulfilled, then the time counting will be reset and the inverter continues enabled.

P0291 – Zero Speed Zone

Refer to the [Item 13.1.4 Digital Outputs / Relays \[41\] on page 13-20](#), for more details.

12.7 FLYING START/RIDE-THROUGH [44]

The FLYING START function allows starting a motor that is spinning freely, accelerating it from the speed it is found.

The other function, RIDE-THROUGH, allows the recovery of the inverter, without being disabled by undervoltage, when a failure in the voltage supply occurs.

Since these functions work in different manners depending on the used control mode (V/f, VVW or Vector), they will be described in full detail next, for each one of the modes.

P0320 – Flying Start/Ride-Through

Adjustable Range:	0 = Off 1 = Flying Start 2 = Flying Start / Ride-Through 3 = Ride-Through	Factory Setting:	0
Properties: CFG and PM			
Access groups via HMI:	<div style="border: 1px solid black; padding: 2px; display: inline-block;">01 PARAMETER GROUPS</div> <div style="border: 1px solid black; padding: 2px; display: inline-block; margin-left: 20px;">44 FlyStart/RideThru</div>		

Description:

The parameter P0320 selects the functions Flying Start and Ride-Through use. More details in the subsequent sections.

12.7.1 V/f Flying Start and VVW

In the V/f and VVW mode, the inverter imposes a fixed frequency at the start, defined by the speed reference, and applies a voltage ramp defined at the parameter P0331. The Flying Start function will be activated after the time adjusted in P0332 elapses (to allow the motor demagnetization), every time a "Run" command is driven.

12.7.2 Vector Flying Start

12.7.2.1 P0202 = 3

The behavior of the Flying Start function (FS) in the sensorless mode during acceleration and reacceleration can be understood from the [Figure 12.6 on page 12-14](#).

The [Figure 12.6 on page 12-14 \(b\)](#) shows the behavior of the speed reference when the FS function is started with stopped motor shaft and small P0329 value (not optimized).

Operation analysis:

1. The frequency equal to the adjustment P0134 is applied with a current equal to $0.9 \times P0401$ (I/f control).
2. The frequency is reduced down to zero using the ramp given by: $P0329 \times P0412$.
3. If the speed is not found during this frequency scan, a new scan in the opposite speed direction is initiated, in which the frequency goes from $[-P0134]$ to zero. After this second scan the FS is finished and the control mode changes to vector sensorless.

The [Figure 12.6 on page 12-14 \(c\)](#) shows the speed reference when the FS function is initiated with the motor shaft already running in the desired direction, or with stopped shaft and an already optimized P0329.

Operation analysis:

1. The frequency equal to the adjustment P0134 is applied with a current equal to $0.9 \times P0401$ (I/f control).
2. The frequency is reduced using the ramp given by: $P0329 \times P0412$ until reaching the motor speed.
3. In this moment the control mode changes to vector sensorless.



NOTE!

In order that the motor speed is found in the first scan, proceed with the P0329 setting in the following manner:

1. Increase P0329 using 1.0 steps.
2. Enable the inverter and observe the motor shaft movement during the FS process.
3. If the shaft rotates in both directions, stop the motor and repeat the steps 1 and 2.



NOTE!

The used parameters are P0327 to P0329.



NOTE!

When the general enable command is activated, the motor magnetization will not occur.



NOTE!

For a better performance of the function, the activation of the braking without losses is recommended by setting the parameter P0185 according to the [Table 11.9 on page 11-31](#).



NOTE!

When parameter P0229 is set to the stop by ramp condition, the speed detection is always performed after the activation of the of the inverter general enable. In case it is necessary to detect the speed whenever the motor is stopped, follow the instruction of parameter P0181 (magnetization mode).

P0327 – F.S. Current Ramp I/f

Adjustable Range:	0.000 to 1.000 s	Factory Setting:	0.070 s
--------------------------	------------------	-------------------------	---------

Description:

It defines the time for the I/f current to change from 0 to (0.9 x P0401) at the beginning of the frequency scan (f), in order to minimize the generation of transients in the motor. The factory value varies according to the motor and is defined by:

$$P0327 = P0412/8$$

P0328 – Flying Start Filter

Adjustable Range:	0.000 to 1.000 s	Factory Setting:	0.085 s
--------------------------	------------------	-------------------------	---------

Description:

It defines an amount of time that allows eliminating the transients generated by the machine during the identification of the motor speed.

The factory value varies according to the motor and is defined by:

$$P0328 = (P0412/8 + 0.015 \text{ s})$$

P0329 – Frequency Ramp I/f F.S.

Adjustable Range:	2.0 to 50.0	Factory Setting:	6.0
--------------------------	-------------	-------------------------	-----

Properties: Sless

Access groups via HMI:	01 PARAMETER GROUPS
	44 FlyStart/RideThru

Description:

It defines the rate of frequency variation used in the motor speed search.

The factory value of P0329 shown in the following table allows the operation of the function and must be optimized; normally the final value adjusted is greater than the value suggested.

Table 12.6 - P0329 value in function of P0404

P0404	0 to 11	12, 13	14, 15	16, 17	18, 19, 20	21, 22
P0329	6.0	7.0	8.0	9.0	10.0	11.0
P0404	23, 24	25, 26	27, 28	29, 30	31, 32	33, 34
P0329	12.0	13.0	14.0	15.0	16.0	17.0
P0404	35, 36	37, 38	39 to 60	-	-	-
P0329	18.0	19.0	20.0	-	-	-

The frequency variation rate is determined by: $(P0329 \times P0412)$.

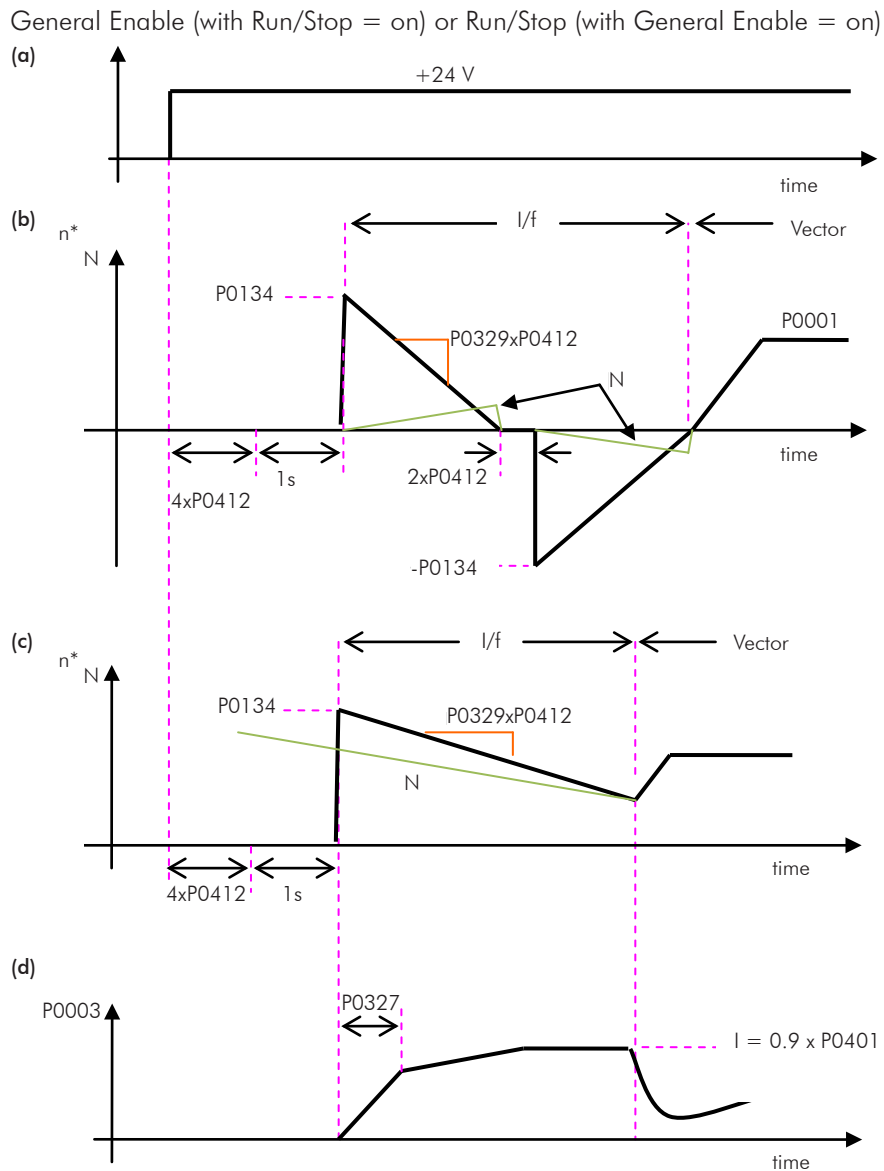

Figure 12.6 - (a) to (d) - Influence of P0327 and P0329 during Flying Start ($P0202 = 3$)



If it is wished to deactivate momentarily the Flying Start function, one can program one of the digital inputs P0263 to P0270 as 24 (Disab.FlyStart). Refer to the [Item 13.1.3 Digital Inputs \[40\]](#) on page 13-12.

12.7.2.2 P0202 = 4

During the time period when the motor is being magnetized, the identification of the motor speed occurs. Once the magnetization is finished, the motor will be operated starting from that speed until reaching the speed reference indicated in P0001.

The parameters P0327 to P0329, P0331 and P0332 are not used.

12.7.3 V/f, VVW and Ride-Through

The Ride-Through function in the V/f or VVW mode will disable the output pulses (IGBT) of the inverter as soon as the input voltage reaches a value below the undervoltage level. The undervoltage fault (F021) does not occur and the DC link voltage will decrease slowly until the line voltage returns.

If the line takes too long to return (more than 2 seconds), the inverter may indicate F021 (DC Link Undervoltage). If the line voltage returns before a fault, the inverter will enable the pulses again, imposing the speed reference instantaneously (as in the Flying Start function) and applying a voltage ramp with the time defined by P0331. Refer to the [Figure 12.7 on page 12-15](#).

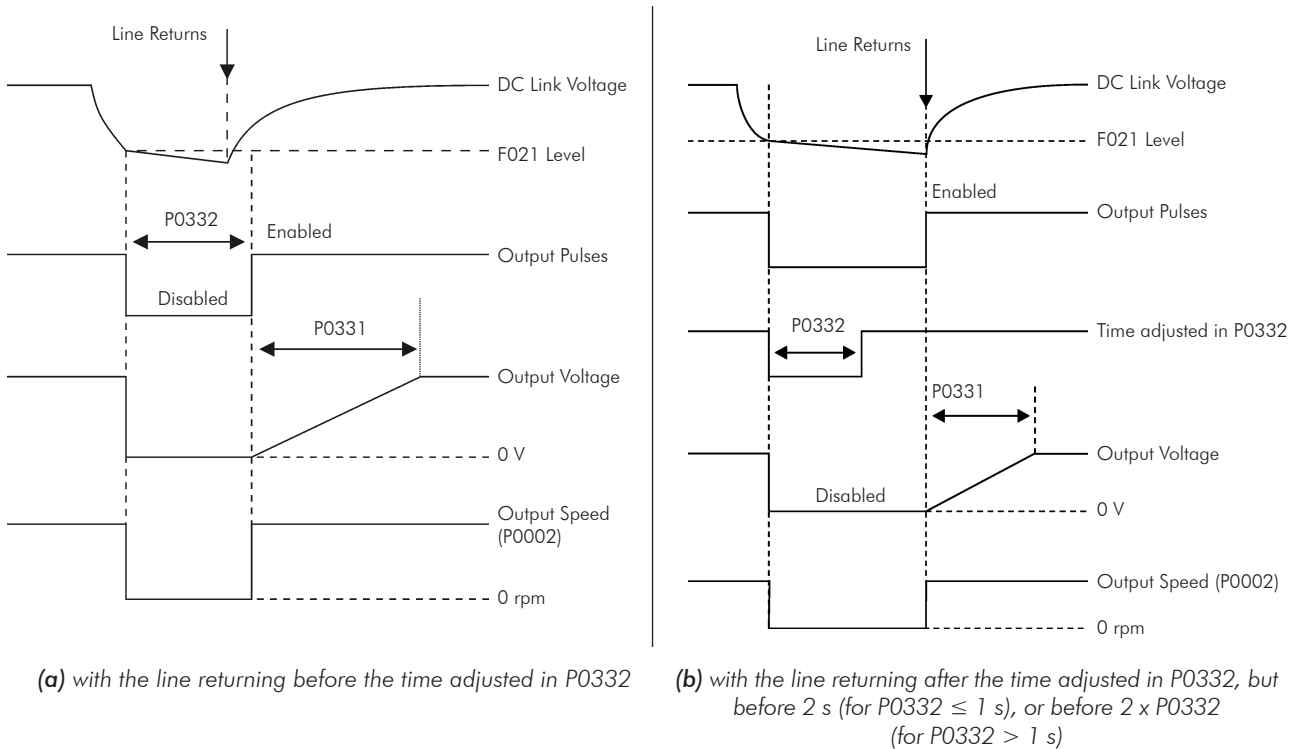

Figure 12.7 - (a) and (b) - Ride-Through actuation in V/f mode

The actuation of the Ride-Through function can be visualized at the outputs DO1/RL1, DO2/RL2, DO3/RL3, DO4 and/or DO5 (P0275 to P0279), provided that they have been programmed in "24 = Ride-Through".

P0331 – Voltage Ramp

Adjustable Range:	0.2 to 60.0 s	Factory Setting:	2.0 s
Properties:	V/f and VVV		
Access groups via HMI:	<div style="border: 1px solid black; padding: 2px; display: inline-block;">01 PARAMETER GROUPS</div> <div style="border: 1px solid black; padding: 2px; display: inline-block; margin-left: 20px;">44 FlyStart/RideThru</div>		

Description:

This parameter sets the necessary time for the output voltage to reach the rated voltage value.

It is used by the Flying Start function as well as by the Ride-Through function (both in V/f and VVV mode), together with the parameter P0332.

P0332 – Dead Time

Adjustable Range:	0.1 to 10.0 s	Factory Setting:	1.0 s
Properties:	V/f and VVV		
Access groups via HMI:	<div style="border: 1px solid black; padding: 2px; display: inline-block;">01 PARAMETER GROUPS</div> <div style="border: 1px solid black; padding: 2px; display: inline-block; margin-left: 20px;">44 FlyStart/RideThru</div>		

Description:

The parameter P0332 sets the minimum time that the inverter will wait to activate the motor again, which is necessary for the motor demagnetization.

In the Ride-Through function case, the time is counted starting from the line drop. However in the Flying Start function actuation, the counting begins after the "Run/Stop = Run" command is given.

For the correct operation, this time must be adjusted to twice the motor rotor constant (refer to the [Table 11.7 on page 11-28](#) in the [Item 11.8.5 Self-Tuning \[05\]](#) and [\[94\]](#) on page 11-24).

12

12.7.4 Vector Ride-Through

Different from the V/f and VVV mode, in the vector mode the Ride-Through function tries to regulate the DC link voltage during the line failure, without interruption or fault storing. The energy necessary to keep the inverter in operation is obtained from the motor kinetic energy (inertia) by means of its deceleration. Thus, at the line return the motor is reaccelerated to the speed defined by the reference.

After the line failure (t0), the DC link voltage (U_d) starts diminishing according to a rate depending on the motor load condition, being able to reach the undervoltage level (t2) if the Ride-Through function is not working. The typical necessary time for this to occur, with rated load, is from a magnitude of 5 to 15 ms.

With the Ride-Through function active, the line loss is detected when the U_d voltage reaches a value below the "DC Link Power Loss" value (t1), defined at the parameter P0321. The inverter initiates a controlled deceleration of the motor immediately, regenerating energy to the DC link in order to keep the motor operating with the U_d voltage regulated at the value "DC Link Ride-Through" (P0322).

In case that the line does not return, undervoltage fault will occur - F021 (at t5). If the line returns before the undervoltage occurrence (t3), the inverter will detect its return when the U_d voltage reaches the "DC Link Power

Back" (t4) level, defined at the parameter P0323. The motor will reaccelerate, following the adjusted ramp, from the actual speed value to the value defined by the speed reference (P0001) (refer to the [Figure 12.8 on page 12-17](#)).

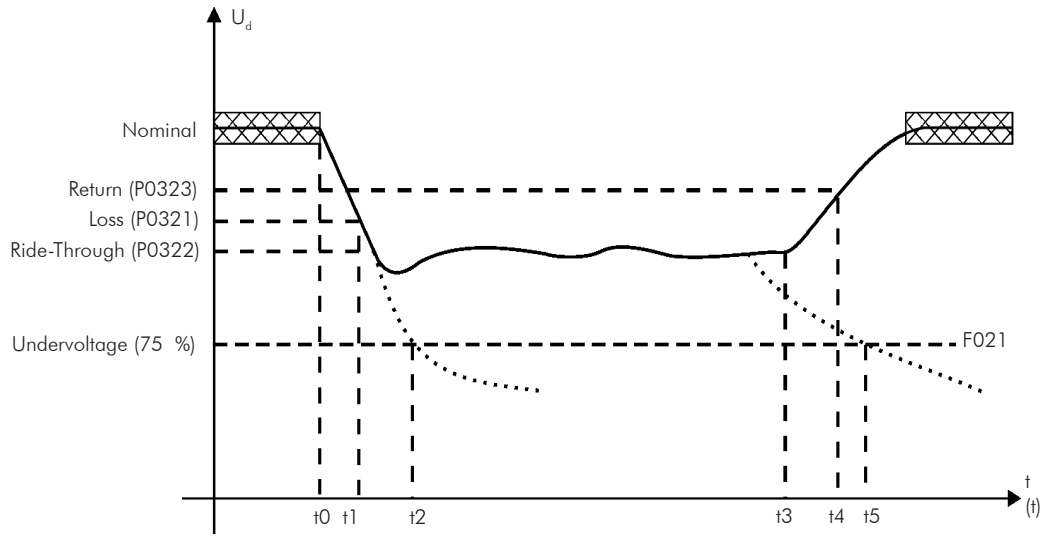

Figure 12.8 - Ride-Through function actuation in vector mode

- t0 – Line loss.
- t1 – Line loss detection.
- t2 – Undervoltage actuation (F021 without Ride-Through).
- t3 – Line return.
- t4 – Line return detection.
- t5 – Undervoltage actuation (F021 with Ride-Through).

If the line voltage produces an U_d voltage between the values adjusted in P0322 and P0323, the fault F0150 may occur, the values of P0321, P0322 and P0323 must be readjusted.



NOTE!

When one of the functions, Ride-Through or Flying Start, is activated, the parameter P0357 (Line Phase Loss Time) is ignored, regardless of the adjusted time.



NOTE!

Cautions with the application:

- All the drive system components must be dimensioned to withstand the application transitory conditions.



NOTE!

The Ride-Through function activation occurs when the power supply voltage is lower than the value (P0321/1.35).

$$U_d = VAC \times 1.35$$

P0321 – DC Link Power Loss

Adjustable Range:	178 to 282 V	Factory Setting:	252 V (P0296 = 0)
	308 to 616 V		436 V (P0296 = 1)
	308 to 616 V		459 V (P0296 = 2)
	308 to 616 V		505 V (P0296 = 3)
	308 to 616 V		551 V (P0296 = 4)
	425 to 737 V		602 V (P0296 = 5)
	425 to 737 V		660 V (P0296 = 6)
	486 to 885 V		689 V (P0296 = 7)
	486 to 885 V		792 V (P0296 = 8)

P0322 – DC Link Ride-Through

Adjustable Range:	178 to 282 V	Factory Setting:	245 V (P0296 = 0)
	308 to 616 V		423 V (P0296 = 1)
	308 to 616 V		446 V (P0296 = 2)
	308 to 616 V		490 V (P0296 = 3)
	308 to 616 V		535 V (P0296 = 4)
	425 to 737 V		585 V (P0296 = 5)
	425 to 737 V		640 V (P0296 = 6)
	486 to 885 V		668 V (P0296 = 7)
	486 to 885 V		768 V (P0296 = 8)

P0323 – DC Link Power Back

Adjustable Range:	178 to 282 V	Factory Setting:	267 V (P0296 = 0)
	308 to 616 V		462 V (P0296 = 1)
	308 to 616 V		486 V (P0296 = 2)
	308 to 616 V		535 V (P0296 = 3)
	308 to 616 V		583 V (P0296 = 4)
	425 to 737 V		638 V (P0296 = 5)
	425 to 737 V		699 V (P0296 = 6)
	486 to 885 V		729 V (P0296 = 7)
	486 to 885 V		838 V (P0296 = 8)

Properties: Vector

Access groups via HMI:	01 PARAMETER GROUPS
	44 FlyStart/RideThru

Description:

- P0321 – defines the U_d voltage level under which the line loss will be detected.
- P0322 – defines the U_d voltage level that the inverter will try to keep regulated, so that the motor keeps operating.
- P0323 – defines the U_d voltage level at which the inverter will identify the return of the line, and from where the motor must be reaccelerated.



NOTE!

These parameters work together with the parameters P0325 and P0326 for the Ride-Through in vector control.

P0325 – Ride-Through Proportional Gain

Adjustable Range: 0.0 to 63.9 Factory Setting: 22.8

P0326 – Ride-Through Integral Gain

Adjustable Range: 0.000 to 9.999 Factory Setting: 0.128

Properties: Vector

Access groups via HMI: 01 PARAMETER GROUPS
44 FlyStart/RideThru

Description:

These parameters configure the vector mode Ride-Through PI controller, which is responsible for keeping the DC link voltage at the level set in P0322.

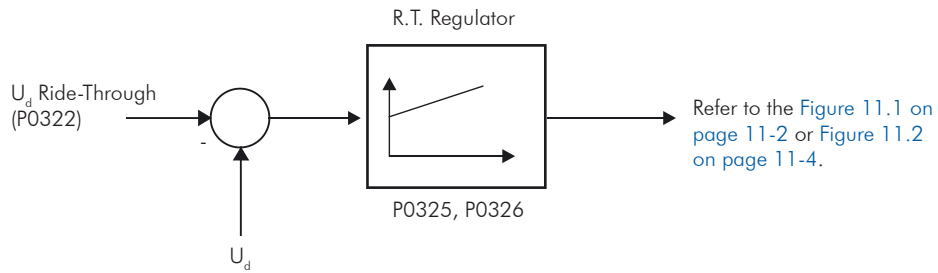

Figure 12.9 - Ride-Through PI controller

Normally the factory settings for P0325 and P0326 are adequate for the majority of the applications. Do not change these parameters.

12.8 DC BRAKING [47]

NOTE! DC break on the start and/or stop will not be active if P0202 = 4 (Vector with Encoder mode).

NOTE! The DC Braking at start does not act when the Flying Start function is active (P0320 = 1 or 2).

The DC BRAKING consists in the application of direct current to the motor, allowing its fast stopping.

Table 12.7 - Parameters related to the DC braking

Control Mode	DC Braking at Starting	DC Braking at Stopping
V/f scalar	P0299 and P0302	P0300, P0301 and P0302
VVV	P0299 and P0302	P0300, P0301 and P0302
Sensorless Vector	P0299 and P0372	P0300, P0301 and P0372

P0299 - DC-Braking Start Time

Adjustable Range:	0.0 to 15.0 s	Factory Setting:	0.0 s
Properties:	V/f, VVV and Sless		
Access groups via HMI:	<div style="border: 1px solid black; padding: 2px; display: inline-block;">01 PARAMETER GROUPS</div> <div style="border: 1px solid black; padding: 2px; display: inline-block; margin-left: 20px;">47 DC Braking</div>		

Description:

This parameter sets the DC braking time at starting.

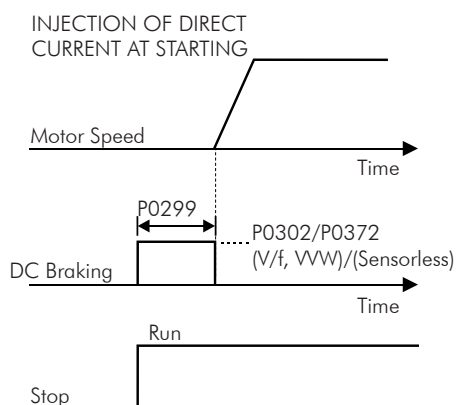

Figure 12.10 - DC braking operation at starting

P0300 – DC-Braking Stop Time

Adjustable Range:	0.0 to 15.0 s	Factory Setting:	0.0 s
Properties:	V/f, VVV and Sless		
Access groups via HMI:	<div style="border: 1px solid black; padding: 2px; display: inline-block;">01 PARAMETER GROUPS</div> <div style="border: 1px solid black; padding: 2px; display: inline-block; margin-left: 20px;">47 DC Braking</div>		

Description:

This parameter sets the DC braking time at stopping.

The [Figure 12.11 on page 12-21](#) presents the DC braking operation via ramp disabling (refer to P0301).

(a) V/f scalar

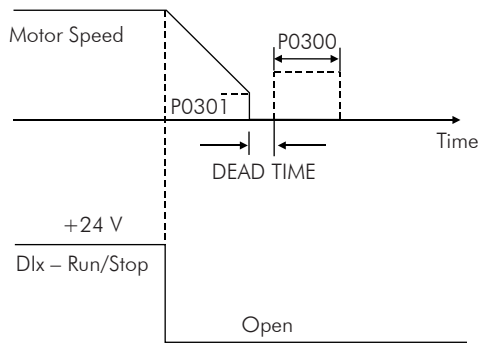

(b) V/W and Sensorless Vector

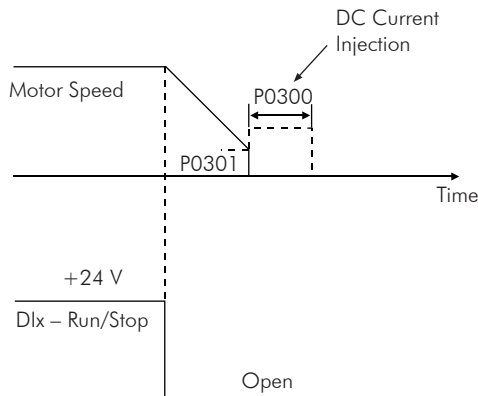

Figure 12.11 - (a) and (b) - DC braking operation at the ramp disabling (via ramp disable)

The Figure 12.12 on page 12-21 presents the DC braking operation via general disabling. This condition does only work in the V/f scalar mode.

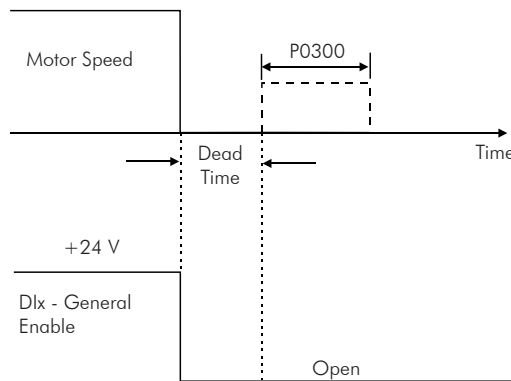

Figure 12.12 - DC braking operation via general disabling – V/f mode

For the V/f scalar control mode there is a "dead time" (motor rotates free), before starting the DC braking. This time is necessary to the demagnetization of the motor and it is proportional to its speed.

During the DC braking the inverter indicates the "DCbreak" status at the keypad (HMI) top left corner.

During the braking process, if the inverter is enabled, the braking is interrupted and the inverter will operate normally again.



ATTENTION!

The DC Braking may continue active after the motor has already stopped. Be careful with the motor thermal sizing for short period cyclic braking.

P0301 – DC-Braking Speed

Adjustable Range:	0 to 450 rpm	Factory Setting:	30 rpm
Properties:	V/f, VVW and Sless		
Access groups via HMI:	<div style="border: 1px solid black; padding: 2px; display: inline-block;">01 PARAMETER GROUPS</div> <div style="border: 1px solid black; padding: 2px; display: inline-block; margin-left: 20px;">47 DC Braking</div>		

Description:

This parameter establishes the beginning point for the DC braking application at stopping. Refer to the [Figure 12.11 on page 12-21 \(a\) and \(b\)](#).

P0302 – DC-Braking Voltage

Adjustable Range:	0.0 to 10.0 %	Factory Setting:	2.0 %
Properties:	V/f and VVW		
Access groups via HMI:	<div style="border: 1px solid black; padding: 2px; display: inline-block;">01 PARAMETER GROUPS</div> <div style="border: 1px solid black; padding: 2px; display: inline-block; margin-left: 20px;">47 DC Braking</div>		

Description:

This parameter adjusts the DC voltage (braking torque) applied to the motor during the braking.

The adjustment must be done by increasing gradually the P0302 value, which varies from 0 to 10 % of the rated voltage, until getting the desired braking.

This parameter works only for the V/f scalar and VVW control modes.

P0372 – DC-Braking Current for Sensorless

Adjustable Range:	0.0 to 90.0 %	Factory Setting:	40.0 %
Properties:	Sless		
Access groups via HMI:	<div style="border: 1px solid black; padding: 2px; display: inline-block;">01 PARAMETER GROUPS</div> <div style="border: 1px solid black; padding: 2px; display: inline-block; margin-left: 20px;">47 DC Braking</div>		

Description:

This parameter adjusts the current level (DC braking torque) applied to the motor during the braking.

The programmed current level is a percentage of the inverter rated current.

This parameter works only in the Sensorless Vector control mode.

12.9 SKIP SPEED [48]

The parameters of this group prevent the motor from operating permanently at speed values where, for instance, the mechanic system enters in resonance (causing exaggerated vibration or noise).

P0303 – Skip Speed 1

Adjustable Range:	0 to 18000 rpm	Factory Setting:	600 rpm
--------------------------	----------------	-------------------------	---------

P0304 – Skip Speed 2

Adjustable Range:	0 to 18000 rpm	Factory Setting:	900 rpm
--------------------------	----------------	-------------------------	---------

P0305 – Skip Speed 3

Adjustable Range:	0 to 18000 rpm	Factory Setting:	1200 rpm
--------------------------	----------------	-------------------------	----------

P0306 – Skip Band

Adjustable Range:	0 to 750 rpm	Factory Setting:	0 rpm
--------------------------	--------------	-------------------------	-------

Properties:

Access groups via HMI:	01 PARAMETER GROUPS
	48 Skip Speed

Description:

This actuation of these parameters occurs as presented in the [Figure 12.13 on page 12-24](#) next.

The passage through the avoided speed range (2 x P0306) takes place by means of the acceleration/deceleration ramps.

The function does not operate properly if two bands of "Skip Speed" overlap.



NOTE!

The speed references that do not pass through the speed ramp, as JOG+, JOG-, P0231, P0236, P0241 or P0246 = 1, are not considered.

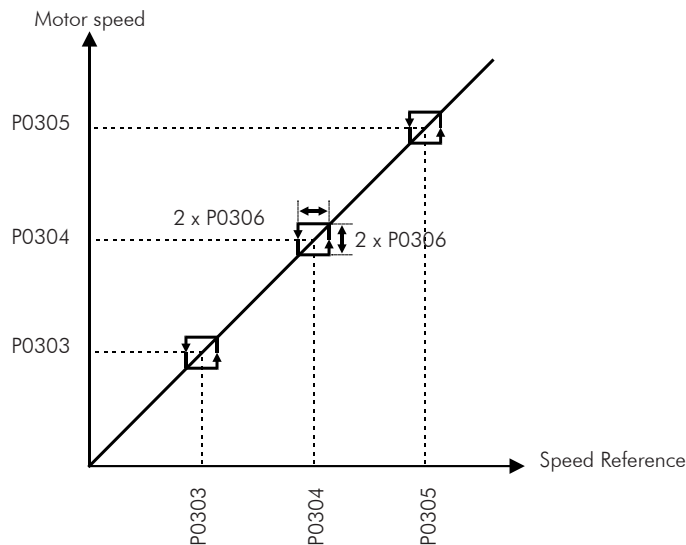

Figure 12.13 - "Skip Speed" actuation curve

12.10 SEARCH OF ZERO OF THE ENCODER

The zero search function attempts to synchronize the minimum counting or the maximum counting visualized in the parameter P0039. Accountant of the Pulses of Encoder, with the pulse of zero of the encoder.

The function is activated by setting P0191 = 1. It will just be executed once, when happening the first zero pulse after the activation of the function.

Among the actions accomplished are: the parameter P0039 is reduced to zero (or fitting with the value of 4 x P0405), and the parameter P0192 starts to indicate P0192 = Completed.

P0191 – Encoder Zero Search

Adjustable Range:	0 = Off 1 = On	Factory Setting: 0
Properties:	V/f, VVW and Vector	
Access groups via HMI:	00 ALL PARAMETERS	

Description:

On the inverter initialization, the parameter P0191 starts on zero. By setting to one, it activates the operation of the zero search function, while the parameter P0192 stays on zero (Inactive).

P0192 – Status Encoder Zero Search

Adjustable	0 = Off	Factory Setting:
Range:	1 = Finished	
Properties:	RO V/f, VVW and Vector	
Access groups via HMI:	00 ALL PARAMETERS	

Description:

On the inverter initialization, this parameter starts on zero.

When the value is changed to 1 (Concluded), it indicates that the zero search function was executed, and this function returns to the state of Inactive, although P0191 continues equal to one (Active).

13 DIGITAL AND ANALOG INPUTS AND OUTPUTS

This section presents the parameters for the configuration of the CFW-11 inputs and outputs, as well as the parameters for the command of the inverter in the Local or Remote Situations.

13.1 I/O CONFIGURATION [07]

13.1.1 Analog Inputs [38]

Two analog inputs (AI1 and AI2) are available in the CFW11 standard configuration, and two more can be added with the accessories (AI3 and AI4). AI4 is available at the IOA-01 or IOB-01 modules; The input AI3 is only available at the IOB-01 module.



NOTE!

The parameters associated with the AI3 and AI4 analog inputs will be showed on the HMI only when the IOA-01 or IOB-01 module is connected into the slot 1 (XC41).

With those inputs it is possible, for instance, the use of an external speed reference or the connection of a sensor for the temperature measurement (PTC). The details for those configurations are described in the following parameters.

P0018 – AI1 Value

P0019 – AI2 Value

P0020 – AI3 Value

P0021 – AI4 Value

Adjustable Range:	-100.00 to 100.00 %	Factory Setting:
Properties:	RO	
Access groups via HMI:	<input type="text" value="07 I/O CONFIGURATION"/> <input type="text" value="38 Analog Inputs"/>	or <input type="text" value="01 PARAMETER GROUPS"/> <input type="text" value="38 Analog Inputs"/>

Description:

These read only parameters indicate the value of the analog inputs AI1 to AI4, as a percentage of the full scale. The indicated values are the ones obtained after the offset action and the multiplication by the gain. Refer to the description of the parameters P0230 to P0250.

P0230 – Analog Input Dead Zone

Adjustable Range:	0 = Off 1 = On	Factory Setting:	0
Properties:			
Access groups via HMI:	07 I/O CONFIGURATION 38 Analog Inputs	or	01 PARAMETER GROUPS 38 Analog Inputs

Description:

This parameter acts only for the analog inputs (Alx) programmed as speed reference, and it defines if the Dead Zone at those inputs is On (1) or Off (0).

If the parameter is configured as Off (P0230 = 0), the signal at the analog input will work on the Speed Reference starting from the minimum value (0 V / 0 mA / 4 mA or 10 V / 20 mA), and will be directly related to the minimum speed programmed at P0133. Refer to the [Figure 13.1 on page 13-2 \(a\)](#).

If the parameter is configured as On (P0230 = 1), the signal at the analog inputs will have a Dead Zone, where the Speed Reference remains in the minimum value (P0133), even with the variation of the input signal. Refer to the [Figure 13.1 on page 13-2 \(b\)](#).

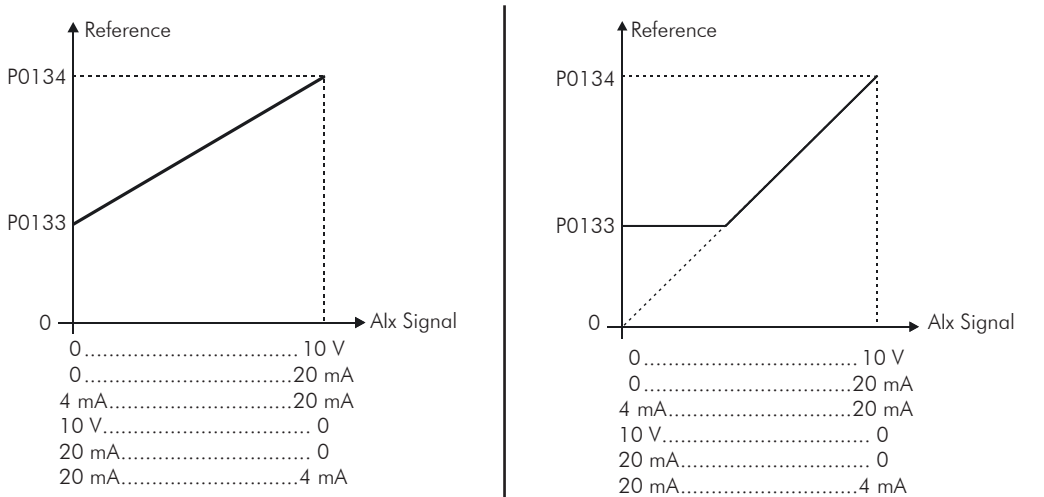

(a) - Analog input actuation with Dead Zone Off

(b) - Analog input actuation with Dead Zone On

Figure 13.1 - (a) and (b) - Analog input actuation

In case that the analog inputs Al2 and Al4 are programmed for -10 V to +10 V (P0238 and P0248 configured in 4), there will be curves identical to those of the [Figure 13.1 on page 13-2](#) above; only when Al2 or Al4 is negative the speed direction will be inverted.

P0231 – AI1 Signal Function

P0236 – AI2 Signal Function

P0241 – AI3 Signal Function

Adjustable Range:	0 = Speed Reference 1 = N* Without Ramp 2 = Maximum Torque Current 3 = Process Variable 4 = PTC 5 = Not Used 6 = Not Used 7 = PLC Use	Factory Setting: 0
--------------------------	--	---------------------------

P0246 – AI4 Signal Function

Adjustable Range:	0 = Speed Reference 1 = N* Without Ramp 2 = Maximum Torque Current 3 = Process Variable 4 = Not Used 5 = Not Used 6 = Not Used 7 = PLC Use	Factory Setting: 0
--------------------------	---	---------------------------

Properties:	CFG	
Access groups via HMI:	07 I/O CONFIGURATION	or
	38 Analog Inputs	01 PARAMETER GROUPS
	38 Analog Inputs	38 Analog Inputs

Description:

The functions of the analog inputs are defined in those parameters.

When the option 0 (Speed Reference) is selected, the analog inputs are able to supply the reference for the motor, subject to the specified limits (P0133 and P0134) and to the ramp action (P0100 to P0103). Therefore, it is also necessary to configure the parameters P0221 and/or P0222, selecting the use of the desired analog input (For more details refer to the description of those parameters in the [Section 13.2 LOCAL AND REMOTE COMMAND](#) on page 13-33 and to the [Figure 13.10](#) on page 13-37 in this manual).

The option 1 (No Ramp Reference – valid only for the vector mode) is used generally as an additional reference signal, for instance in applications using a dancer (Refer to the [Figure 13.10](#) on page 13-37, option without acceleration and deceleration ramp).

The option 2 (Maximum Torque Current) makes it possible that the forward and reverse torque current limit control be done by means of the selected analog input. In this case P0169 and P0170 are not used.

The adjustment done at the analog input AI1, AI2, AI3 or AI4 can be monitored via parameters P0018, P0019, P0020 or P0021 respectively, The value presented at this parameter will be the maximum torque current expressed as a percentage of the motor rated current (P0401). The indication range will be from 0 to 200 %. When the analog input is equal to 10 V (maximum), the corresponding monitoring parameter will show 200 %, and the value of the maximum forward and reverse torque current will be 200 %.

In order that the expressions which determine the total current and the maximum torque developed by the motor (Section 11.5 TORQUE CONTROL on page 11-7 and Item 11.8.6 Torque Current Limitation [95] on page 11-29) remain valid, replace P0169, P0170 by P0018 to P0021.

The option 3 (Process Variable) defines the analog input as the PID Regulator feedback signal (E.g.: pressure sensor, temperature, etc.). Therefore it is also necessary to configure the parameter P0524 (PID Feedback Selection).

When the analog input is at its maximum limit (P0018 to P0021 indicating 100 %), the process variable will also be at the maximum value (100 %).

The option 4 (PTC – not available for the AI4 input) configures the input for motor temperature monitoring by means of a PTC type sensor, when it is present in the motor. Therefore it is also necessary to configure one analog output (AO) as a current source for feeding the PTC. More details of this function are described in the Section 15.2 MOTOR OVERTEMPERATURE PROTECTION on page 15-2.

The option 7 (PLC use) configures the signal at the input to be used by the PLC11 board.

P0232 – AI1 Gain

P0237 – AI2 Gain

P0242 – AI3 Gain

P0247 – AI4 Gain

Adjustable Range:	0.000 to 9.999	Factory Setting:	1.000
-------------------	----------------	------------------	-------

P0234 – AI1 Offset

P0239 – AI2 Offset

P0244 – AI3 Offset

P0249 – AI4 Offset

Adjustable Range:	-100.00 to 100.00 %	Factory Setting:	0.00 %
-------------------	---------------------	------------------	--------

P0235 – AI1 Filter

P0240 – AI2 Filter

P0245 – AI3 Filter

13

P0250 – AI4 Filter

Adjustable Range: 0.00 to 16.00 s **Factory Setting:** 0.00 s

Properties:

Access groups via HMI: 07 I/O CONFIGURATION or 01 PARAMETER GROUPS
 38 Analog Inputs 38 Analog Inputs

Description:

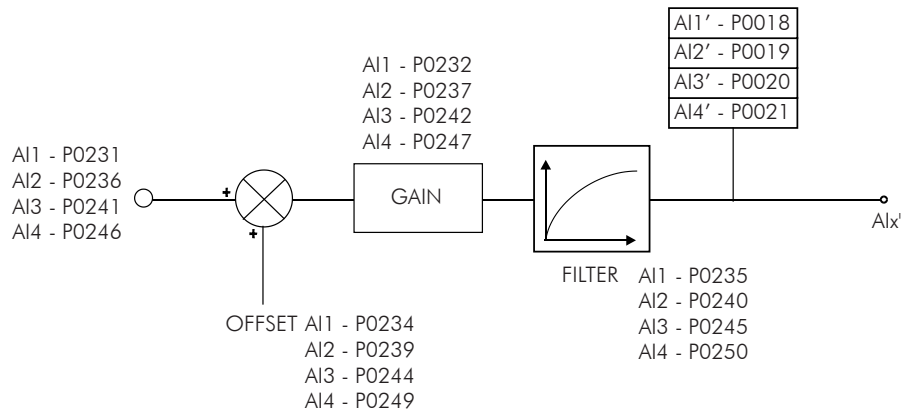

Figure 13.2 - Analog input block diagram

The Alx' internal value is the result of the following equation:

$$Alx' = \left(Alx + \frac{OFFSET}{100} \times 10 V \right) \times Gain$$

For instance: Alx=5 V, OFFSET=-70 % and Gain=1.000:

$$Alx' = \left(5 + \frac{(-70)}{100} \times 10 V \right) \times 1 = -2 V$$

Alx'=-2 V means that the motor will rotate in the reverse direction with a reference in module equal to 2 V, provided that the Alx function is "Speed Reference". For the Alx function "Maximum Torque Current", negative values are clipped at 0.0 %.

For the filter parameters (P0235, P0240, P0245 and P0250), the adjusted value corresponds to the RC constant used for filtering the signal read at the input.

P0233 – AI1 Signal Type

P0243 – AI3 Signal Type

Adjustable Range:	0 = 0 to 10 V/20 mA 1 = 4 to 20 mA 2 = 10 V/20 mA to 0 3 = 20 to 4 mA	Factory Setting:	0
--------------------------	--	-------------------------	---

P0238 – AI2 Signal Type

P0248 – AI4 Signal Type

Adjustable Range:	0 = 0 to 10 V/20 mA 1 = 4 to 20 mA 2 = 10 V/20 mA to 0 3 = 20 to 4 mA 4 = -10 V to +10 V	Factory Setting: 0
Properties:	CFG	
Access groups via HMI:	07 I/O CONFIGURATION 38 Analog Inputs	or 01 PARAMETER GROUPS 38 Analog Inputs

Description:

These parameters configure the signal type (if it is current or voltage) that will be read at each analog input, as well as its range. Refer to the [Table 13.1 on page 13-6](#) and [Table 13.2 on page 13-6](#) for more details on this configuration.

Table 13.1 - DIP Switches related to the analog inputs

Parameter	Input	Switch	Location
P0233	AI1	S1.4	Control Board
P0238	AI2	S1.3	
P0243	AI3	S3.1	IOB
P0248	AI4	S3.1	IOA

Table 13.2 - Configuration of the analog input signals

P0233, P0243	P0238, P0248	Input Signal	Switch Position
0	0	(0 to 10) V / (0 to 20) mA	Off/On
1	1	(4 to 20) mA	On
2	2	(10 to 0) V / (20 to 0) mA	Off/On
3	3	(20 to 4) mA	On
-	4	(-10 to +10) V	Off

13

When current signals are used at the input, the switch corresponding to the desired input must be set in the "ON" position.

Inverse reference is obtained with the options 2 and 3, i.e., maximum speed is obtained with minimum reference.

13.1.2 Analog Outputs [39]

In the CFW-11 standard configuration are available 2 analog outputs (AO1 and AO2), and 2 more (AO3 and AO4) can be added with the IOA-01 accessory. The parameters related to those outputs are described next.



NOTE!

The parameter associated with the AO3 and AO4 analog outputs will be showed on the HMI only when the IOA-01 module is connected into the Slot 1 (XC41).

P0014 – AO1 Value

P0015 – AO2 Value

Adjustable Range:	0.00 to 100.00 %	Factory Setting:
--------------------------	------------------	-------------------------

P0016 – AO3 Value

P0017 – AO4 Value

Adjustable Range:	-100.00 to 100.00 %	Factory Setting:
--------------------------	---------------------	-------------------------

Properties:	RO						
Access groups via HMI:	<table border="1"> <tr> <td>07 I/O CONFIGURATION</td> </tr> <tr> <td>39 Analog Outputs</td> </tr> </table>	07 I/O CONFIGURATION	39 Analog Outputs	or	<table border="1"> <tr> <td>01 PARAMETER GROUPS</td> </tr> <tr> <td>39 Analog Outputs</td> </tr> </table>	01 PARAMETER GROUPS	39 Analog Outputs
07 I/O CONFIGURATION							
39 Analog Outputs							
01 PARAMETER GROUPS							
39 Analog Outputs							

Description:

Those read only parameters indicate the value of the analog outputs AO1 to AO4, as a percentage of the full scale. The indicated values are those obtained after the multiplication by the gain. Refer to the description of the parameters P0251 to P0261.

P0251 – AO1 Function

P0254 – AO2 Function

Adjustable Range:	0 = Speed Reference 1 = Total Reference 2 = Real Speed 3 = Torque Current Reference 4 = Torque Current 5 = Output Current 6 = Process Variable 7 = Active Current 8 = Output Power 9 = PID Setpoint 10 = Torque Current > 0 11 = Motor Torque 12 = SoftPLC 13 = PTC 14 = Energy Sav Flux 15 = Not Used 16 = Motor Ixt 17 = Encoder Speed 18 = P0696 Value 19 = P0697 Value 20 = P0698 Value 21 = P0699 Value 22 = PLC11 23 = Id* Current	Factory Setting:	P0251 = 2 P0254 = 5
--------------------------	---	-------------------------	------------------------

P0257 – AO3 Function

P0260 – AO4 Function

Adjustable Range:	0 = Speed Reference 1 = Total Reference 2 = Real Speed 3 = Torque Current Reference 4 = Torque Current 5 = Output Current 6 = Process Variable 7 = Active Current 8 = Output Power 9 = PID Setpoint 10 = Torque Current > 0 11 = Motor Torque 12 = SoftPLC 13 = Not Used 14 = Energy Sav Flux 15 = Not Used 16 = Motor lxt 17 = Encoder Speed 18 = P0696 Value 19 = P0697 Value 20 = P0698 Value 21 = P0699 Value 22 = Not Used 23 = Id* Current 24 to 71 = Variables for use in special situations by qualified technical personnel. Refer to the Quick Parameter Reference.	Factory Setting: P0257 = 2 P0260 = 5
--------------------------	---	--

Properties:

Access groups via HMI:	07 I/O CONFIGURATION	or	01 PARAMETER GROUPS
	39 Analog Outputs		39 Analog Outputs

Description:

These parameters set the functions of the analog outputs, according to the [Table 13.3 on page 13-9](#).

Table 13.3 - Analog output functions

Functions	P0251 (AO1)	P0254 (AO2)	P0257 (AO3)	P0260 (AO4)
Speed Reference	0	0	0	0
Total Reference	1	1	1	1
Real Speed	2*	2	2*	2
Torque Current Reference (Vector Mode)	3	3	3	3
Torque Current (Vector Mode)	4	4	4	4
Output Current (with a 0.3 second filter)	5	5*	5	5*
PID Process Variable	6	6	6	6
Active Current (V/f or VVW Mode, with a 0.1 second filter)	7	7	7	7
Output Power (with a 0.5 second filter)	8	8	8	8
PID Setpoint	9	9	9	9
Torque Current > 0 (Vector Mode)	10	10	10	10
Motor Torque	11	11	11	11
SoftPLC	12	12	12	12
PTC	13	13	-	-
Not Used	14 and 15	14 and 15	13, 14, 15 and 22	13, 14, 15 and 22
Motor Ixt	16	16	16	16
Encoder Speed	17	17	17	17
P0696 Value	18	18	18	18
P0697 Value	19	19	19	19
P0698 Value	20	20	20	20
P0699 Value	21	21	21	21
PLC11	22	22	-	-
Id* Current	23	23	23	23
Exclusive WEG Use	-	-	24 to 71	24 to 71

* Factory Setting

P0252 – AO1 Gain

P0255 – AO2 Gain

P0258 – AO3 Gain

P0261 – AO4 Gain

Adjustable Range:	0.000 to 9.999	Factory Setting:	1.000
Properties:			
Access groups via HMI:	07 I/O CONFIGURATION	or	01 PARAMETER GROUPS
	39 Analog Outputs		39 Analog Outputs

Description:

They adjust the analog output gains. Refer to the [Figure 13.3 on page 13-10](#).

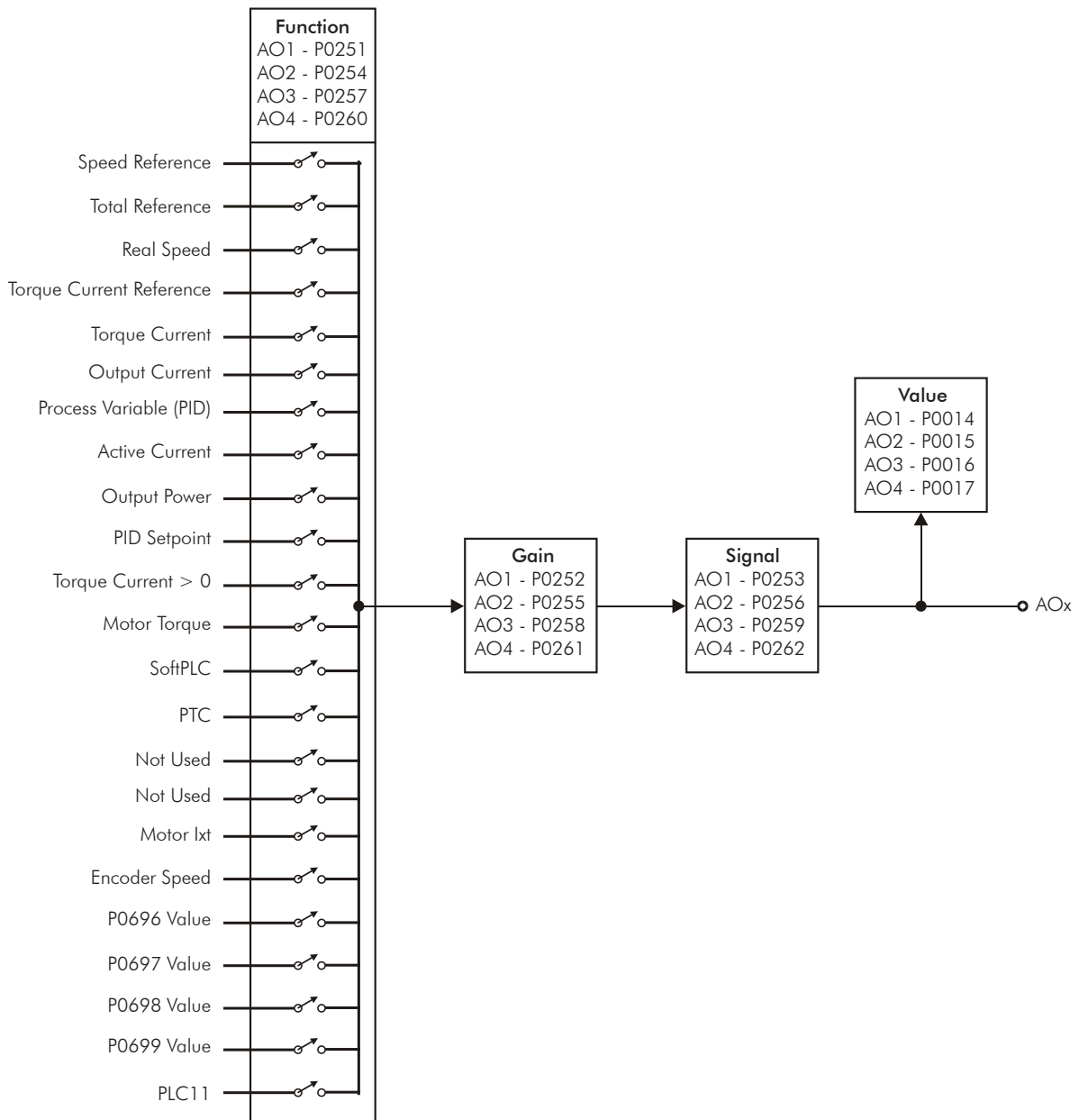

Figure 13.3 - Analog output block diagram

Table 13.4 - Full scale

SCALE OF THE ANALOG OUTPUT INDICATIONS	
Variable	Full Scale (*)
Speed Reference	P0134
Total Reference	
Real Speed	
Encoder Speed	
Torque Current Reference	$2.0 \times I_{nomHD}$
Torque Current > 0	
Motor Torque	$2.0 \times I_{nom}$
Output Current	$1.5 \times I_{nomHD}$
Active Current	
PID Process Variable	P0528
PID Setpoint	
Output Power	$1.5 \times \sqrt{3} \times P0295 \times P0296$
Motor Ixt	100 %
SoftPLC	32767
P0696 Value	
P0697 Value	
P0698 Value	
P0699 Value	

(*) When the signal is inverse (10 to 0 V, 20 to 0 mA or 20 to 4 mA) the values in the table become the beginning of the scale.

P0253 – AO1 Signal Type

P0256 – AO2 Signal Type

Adjustable Range:	0 = 0 to 10 V/20 mA 1 = 4 to 20 mA 2 = 10 V/20 mA to 0 3 = 20 to 4 mA	Factory Setting: 0
--------------------------	--	---------------------------

P0259 – AO3 Signal Type

P0262 – AO4 Signal Type

Adjustable Range:	0 = 0 to 20 mA 1 = 4 to 20 mA 2 = 20 mA to 0 3 = 20 to 4 mA 4 = 0 to 10 V 5 = 10 to 0 V 6 = -10 to +10 V	Factory Setting: 4
Properties:	CFG	
Access groups via HMI:	07 I/O CONFIGURATION 39 Analog Outputs	or 01 PARAMETER GROUPS 39 Analog Outputs

Description:

These parameters configure if the analog output signal will be in current or voltage, with direct or inverse reference.

In order to adjust these parameters, it is also necessary to set the "DIP switches" of the control board or of the IOA Accessory Board, according to the [Table 13.5 on page 13-12](#), [Table 13.6 on page 13-12](#) and [Table 13.7 on page 13-12](#).

Table 13.5 - DIP switches related to the analog outputs

Parameter	Output	Switch	Location
P0253	AO1	S1.1	Control Board
P0256	AO2	S1.2	
P0259	AO3	S2.1	IOA
P0262	AO4	S2.2	

Table 13.6 - Configuration of the analog outputs AO1 and AO2 signals

P0253, P0256	Output Signal	Switch Position
0	(0 to 10) V / (0 to 20) mA	On/Off
1	(4 to 20) mA	Off
2	(10 to 0) V / (20 to 0) mA	On/Off
3	(20 to 4) mA	Off

Table 13.7 - Configuration of the analog outputs AO3 and AO4 signals

P0259, P0262	Output Signal	Switch Position
0	0 to 20 mA	Off
1	4 to 20 mA	Off
2	20 to 0 mA	Off
3	20 to 4 mA	Off
4	0 to 10 V	Off
5	10 to 0 V	Off
6	-10 to +10 V	On

For AO1 and AO2, when current signals are used, the switch corresponding to the desired output must be set in the "OFF" position.

For AO3 and AO4, when current signals are used, the outputs AO3 (I) and AO4 (I) must be used. For voltage signals use the outputs AO3 (V) and AO4 (V). The switch corresponding to the desired output must be set in "ON" only in order to use range from -10 V to +10 V .

13.1.3 Digital Inputs [40]

The CFW-11 has 6 digital inputs in the standard version, and 2 more can be added with the IOA-01 and IOB-01 accessories. The parameters that configure those inputs are presented next.

13

P0012 – DI8 to DI1 Status

Adjustable Range:	Bit 0 = DI1 Bit 1 = DI2 Bit 2 = DI3 Bit 3 = DI4 Bit 4 = DI5 Bit 5 = DI6 Bit 6 = DI7 Bit 7 = DI8	Factory Setting:
Properties:	RO	
Access groups via HMI:	07 I/O CONFIGURATION 40 Digital Inputs	or 01 PARAMETER GROUPS 40 Digital Inputs

Description:

By means of this parameter it is possible to visualize the status of the 6 control board digital inputs (DI1 to DI6) and of the 2 accessory digital inputs (DI7 and DI8) as well.

The indication is done by means of the numbers 1 and 0, representing respectively the "Active" and "Inactive" states of the inputs. The state of each input is considered as one digit in the sequence where DI1 represents the least significant digit.

Example: In case the sequence **10100010** is presented on the keypad (HMI), it will correspond to the following status of the DIs:

Table 13.8 - Digital inputs status

DI8	DI7	DI6	DI5	DI4	DI3	DI2	DI1
Active (+24 V)	Inactive (0 V)	Active (+24 V)	Inactive (0 V)	Inactive (0 V)	Inactive (0 V)	Active (+24 V)	Inactive (0 V)

P0263 – DI1 Function

P0264 – DI2 Function

P0265 – DI3 Function

P0266 – DI4 Function

P0267 – DI5 Function

P0268 – DI6 Function

P0269 – DI7 Function

P0270 - DI8 Function

Adjustable Range:	0 to 31	Factory Setting:	P0263 = 1 P0264 = 8 P0265 = 0 P0266 = 0 P0267 = 10 P0268 = 14 P0269 = 0 P0270 = 0
--------------------------	---------	-------------------------	--

Properties:			
Access groups via HMI:	07 I/O CONFIGURATION	or	01 PARAMETER GROUPS
	40 Digital Input		40 Digital Input

Description:

Those parameters make it possible to configure the functions of the digital inputs, according to the adjustable range listed in [Table 13.9 on page 13-14](#).

Table 13.9 - Digital input functions

Functions	P0263 (DI1)	P0264 (DI2)	P0265 (DI3)	P0266 (DI4)	P0267 (DI5)	P0268 (DI6)	P0269 (DI7)	P0270 (DI8)
Not used	0, 13 and 23	0, 13 and 23	0*, 13 and 23	0* and 23	0 and 23	0 and 23	0*, 13 and 23	0*, 13 and 23
Run/Stop	1*	1	1	1	1	1	1	1
General Enable	2	2	2	2	2	2	2	2
Fast Stop	3	3	3	3	3	3	3	3
FWD Run	4	4	4	4	4	4	4	4
REV Run	5	5	5	5	5	5	5	5
Start	6	6	6	6	6	6	6	6
Stop	7	7	7	7	7	7	7	7
FWD/REV	8	8*	8	8	8	8	8	8
LOC/REM	9	9	9	9	9	9	9	9
JOG	10	10	10	10	10*	10	10	10
Increase E.P.	11	11	11	11	11	11	11	11
Decrease E.P.	12	12	12	12	12	12	12	12
Multispeed	-	-	-	13	13	13	-	-
Ramp 2	14	14	14	14	14	14*	14	14
Speed/Torque	15	15	15	15	15	15	15	15
JOG+	16	16	16	16	16	16	16	16
JOG-	17	17	17	17	17	17	17	17
No Ext. Alarm	18	18	18	18	18	18	18	18
No Ext. Fault	19	19	19	19	19	19	19	19
Reset	20	20	20	20	20	20	20	20
PLC Use	21	21	21	21	21	21	21	21
Manual/Auto	22	22	22	22	22	22	22	22
Disable FlyStart	24	24	24	24	24	24	24	24
DC Link Regul.	25	25	25	25	25	25	25	25
Program. Off	26	26	26	26	26	26	26	26
Load User 1/2	27	27	27	27	27	27	27	27
Load User 3	28	28	28	28	28	28	28	28
DO2 Timer	29	29	29	29	29	29	29	29
DO3 Timer	30	30	30	30	30	30	30	30
Trace Function	31	31	31	31	31	31	31	31

*** Factory setting**

Some notes regarding the Digital Input functions are presented next.

- **Run/Stop:** In order to assure the correct operation of this function, it is necessary to program P0224 and/or P0227 in 1.
- **Fast Stop:** The "Run/Stop = Stop" command is executed with null deceleration ramp, regardless of the P0101 or P0103 setting. Its use is not recommended with V/f and VVW control modes.
- **Increase E.P. and Decrease E.P. (Electronic Potentiometer):** They are active when +24 V is applied (for Increasing E.P.) or 0 V (for Decreasing E.P.) at the respective input programmed for that function. It is also necessary to program P0221 and/or P0222 in 7. Refer to the [Section 12.5 ELECTRONIC POTENTIOMETER \[37\] on page 12-9](#).
- **Local/Remote:** When programmed, this function activates "Local" when 0 V is applied to the input, and "Remote" when +24 V are applied. It is also necessary to program P0220 = 4 (DIx).
- **Speed/Torque:** This function is valid for P0202 = 3 or 4 (Sensorless Vector Control or Vector with Encoder), and "Speed" is selected with 0 V applied to the input, whereas "Torque" by applying 24 V.

When **Torque** is selected, the speed regulator parameters P0161 and P0162 become inactive (*). Thus, the Total Reference becomes the input of the Torque Current Regulator. Refer to the [Figure 11.1 on page 11-2](#) and [Figure 11.2 on page 11-4](#).

(*) The PID-type speed regulator is converted into a P-type regulator with proportional gain 1.00 and null integral gain.

When **Speed** is selected, the gains of the speed regulator become again defined by P0161 and P0162. In the applications with torque control it is recommended to follow the method described at the parameter P0160.

- **DC Link Regulation:** it must be used when P0184 = 2. For more details, refer to this parameter description in the [Item 11.8.7 DC Link Regulator \[96\] on page 11-30](#), of this manual.
- **JOG+ and JOG-:** those are functions valid only for P0202 = 3, 4, 6 or 7.
- **Disables Flying-Start:** it is valid for P0202 ≠ 4. By applying +24 V to the digital input programmed for this purpose, the Flying-Start function is disabled. By applying 0 V, the Flying-Start function is enabled again, provided that P0320 be equal to 1 or 2. Refer to the [Section 12.7 FLYING START/RIDE-THROUGH \[44\] on page 12-11](#).
- **Load User 1/2:** this function allows the selection of the user memory 1 or 2, in a similar process than P0204 = 7 or 8, with the difference that the user memory is loaded from a transition of the Dlx programmed for this function.

When the state of the Dlx changes from low level to high level (transition from 0 V to 24 V), the user memory 1 is loaded, provided that the contents of the inverter actual parameters had been previously transferred to the parameter memory 1 (P0204 = 10).

When the state of the Dlx changes from high level to low level (transition from 24 V to 0 V), the user memory 2 is loaded, provided that the contents of the inverter actual parameters had been previously transferred to the parameter memory 2 (P0204 = 11).

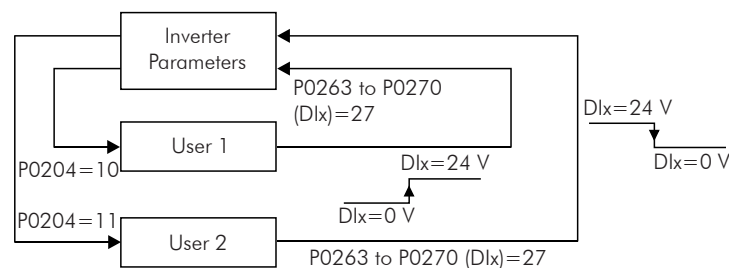

Figure 13.4 - Details on the working of the Load User 1/2 function

- **Load User 3:** this function allows the selection of the user memory 3, in a similar process than P0204 = 9, with the difference that the user memory is loaded from a transition of the Dlx programmed for this function.

When the Dlx state changes from low level to high level (transition from 0 V to 24 V), the user memory 3 is loaded, provided that the contents of the inverter actual parameters had been previously transferred to the parameter memory 3 (P0204 = 12).



NOTE!

- ☑ Make sure that when using those functions the parameter sets (user memory 1, 2 or 3) be totally compatible with the application (motors, Run/Stop commands, etc.).
- ☑ It will not be possible to load the user memory with the inverter enabled.
- ☑ If two or three parameter sets from different motors were saved in the user memories 1, 2 and/or 3, the correct current values must be adjusted at the parameters P0156, P0157 and P0158 for each user memory.

- **Programming Off:** when this function is programmed and the digital input is with +24 V, parameter changes will not be allowed, regardless of the values set at P0000 and P0200. When the DIx input is with 0 V, the parameter changes will be conditioned to the P0000 and P0200 settings.
- **DO2 and DO3 Timer:** this function acts as a timer to activate and deactivate the relays 2 and 3 (DO2 and DO3).

When the timer function for the relay 2 or 3 is programmed at any DIx, and a transition from 0 V to +24 V occurs, the programmed relay will be activated with the delay set in P0283 (DO2) or P0285 (DO3). When a transition from +24 V to 0 V occurs, the programmed relay will be deactivated with the delay adjusted in P0284 (DO2) or P0286 (DO3).

After the transition of the DIx, either for activating or deactivating the programmed relay, it is necessary that the DIx remains in ON or OFF during at least the time set in P0283/P0285 or P0284/P0286. Otherwise the timer will be reset. Refer to the [Figure 13.5 on page 13-16](#).

Note: In order to enable that function it is also necessary to program P0276 and/or P0277 = 29 (Timer).

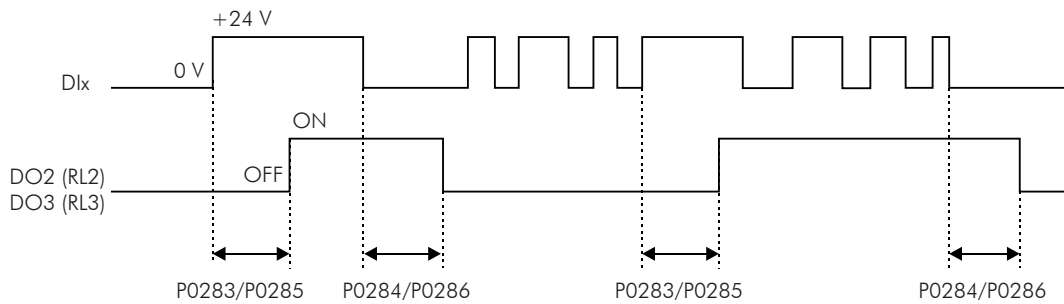
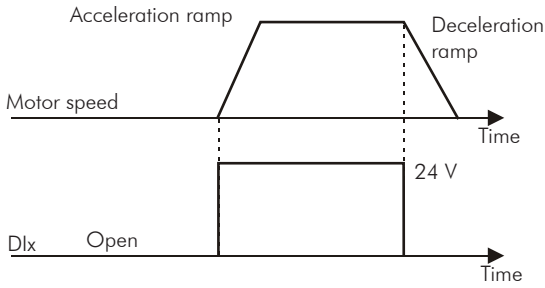

Figure 13.5 - Operation of the timer function DO2 (RL2) and DO3 (RL3)

- **Multispeed:** the setting of the parameters P0266 and/or P0267 and/or P0268 = 13 requires that the parameters P0221 and/or P0222 be programmed in 8. Refer to the description of the parameters P0124 to P0131 in the [Section 12.4 MULTISPEED \[36\] on page 12-7](#).
- **Trace Function:** it triggers the data acquisition at the channels selected with that function, when the three following conditions were fulfilled:
 - If the DIx is with 24 V.
 - Trigger condition set in P0552 = 6 "DIx".
 - Function waiting for the trigger, P0576 = 1 "Waiting".
 For more details refer to the [Chapter 19 TRACE FUNCTION \[52\] on page 19-1](#).
- **No External Alarm:** This function will indicate "External Alarm" (A090) on the keypad (HMI) display when the programmed digital input is open (0 V). If +24 V is applied to the input, the alarm message will disappear automatically from the keypad (HMI) display. The motor keeps working normally, regardless of the state of that input.
- **Manual/Automatic:** It allows selecting the CFW-11 speed reference between the reference defined by P0221/P0222 (Manual mode – DIx open) and the reference defined by the PID regulator (Automatic mode – DIx with 24 V). Refer to the [Chapter 20 PID REGULATOR \[46\] on page 20-1](#), for more details.
- **PLC use:** When this option is selected it will not take any action for the CFW-11. It can be used as a remote input for the PLC11 board or for communication networks.

(a) RUN/STOP



Note: All the digital inputs programmed for General Enable, Fast Stop, Forward Run or Reverse Run must be in the ON state, so that the CFW-11 operates as described above.

(b) GENERAL ENABLE

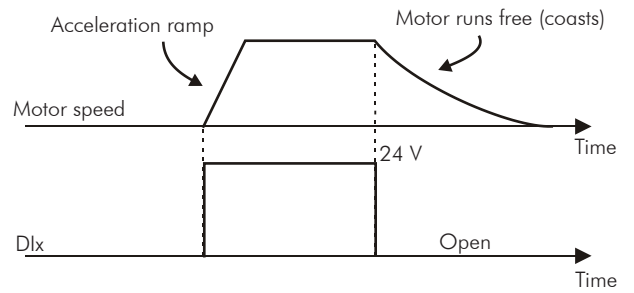

Note: All the digital inputs programmed for Run/Stop, Fast Stop, Forward Run or Reverse Run must be in the ON state, so that the CFW-11 operates as described above.

(c) NO EXTERNAL FAULT

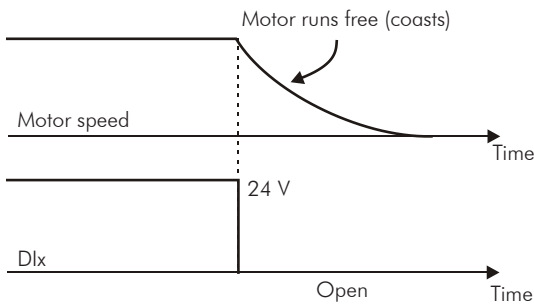

(d) FWD/REV

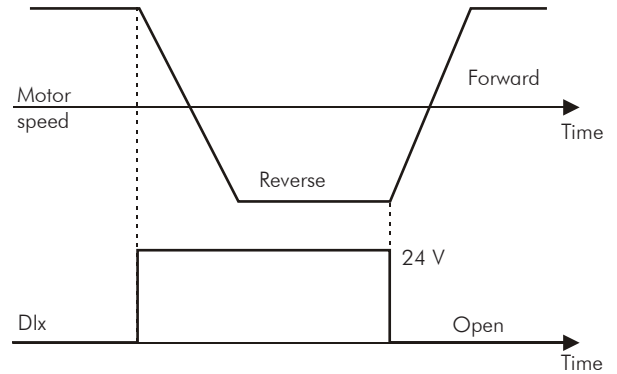

(e) RAMP 2

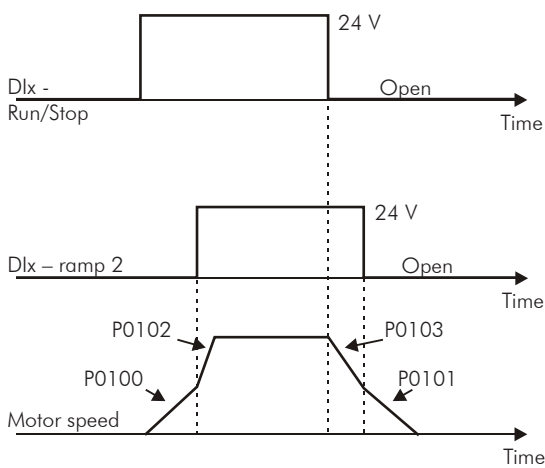

(f) FAST STOP

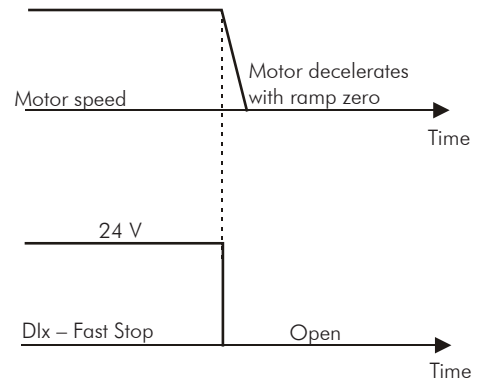

(g) LOAD USER VIA DlX

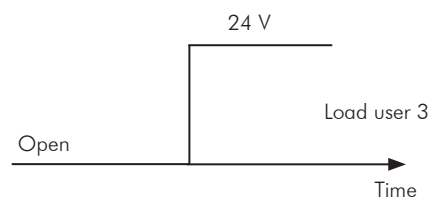
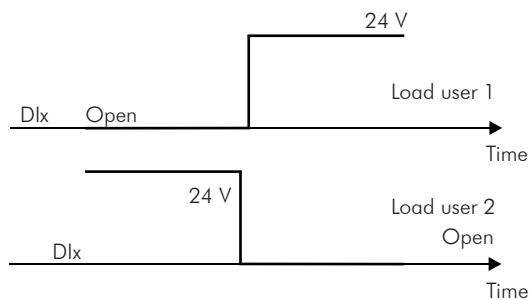

(h) JOG

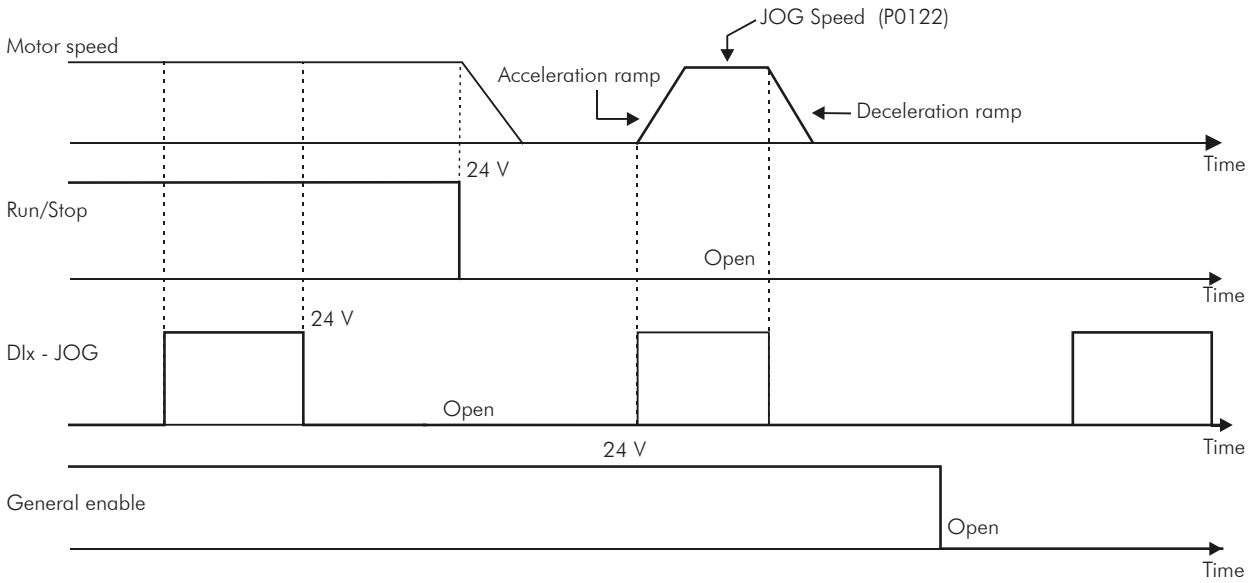

(i) JOG + and JOG -

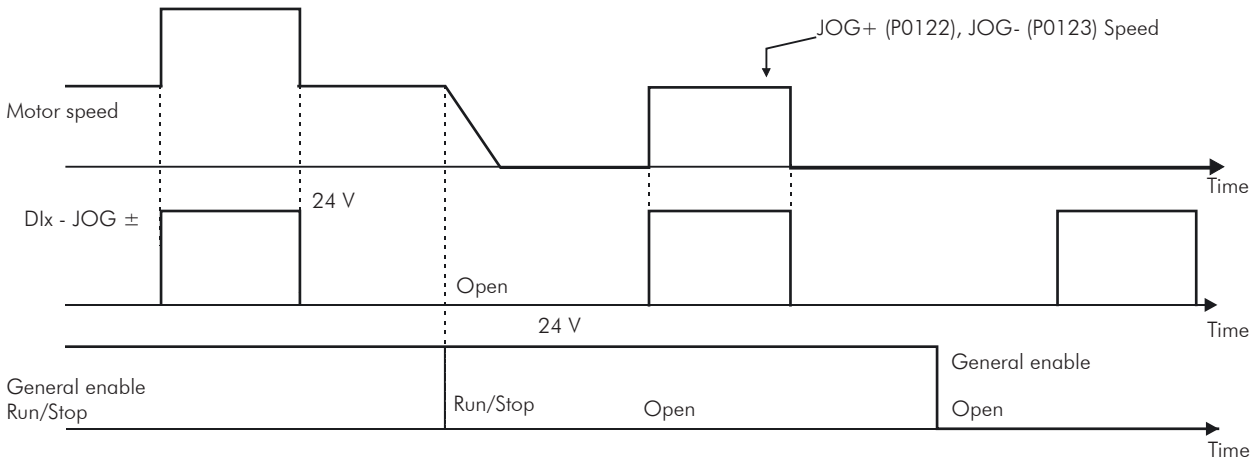

(i) RESET

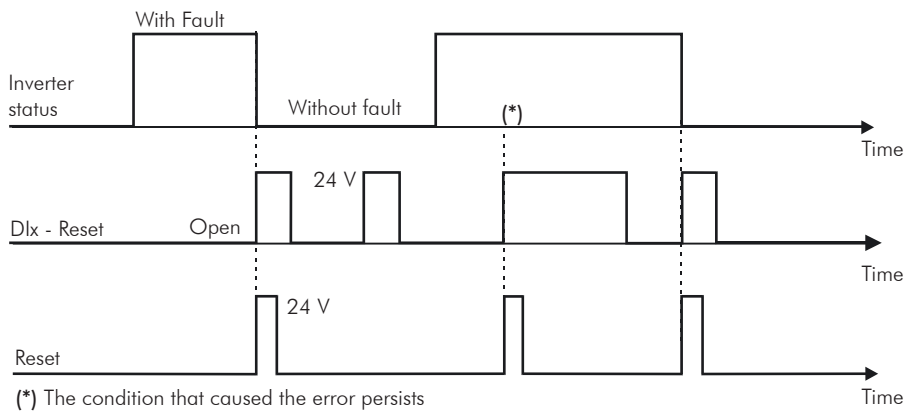

(k) 3-WIRE START / STOP

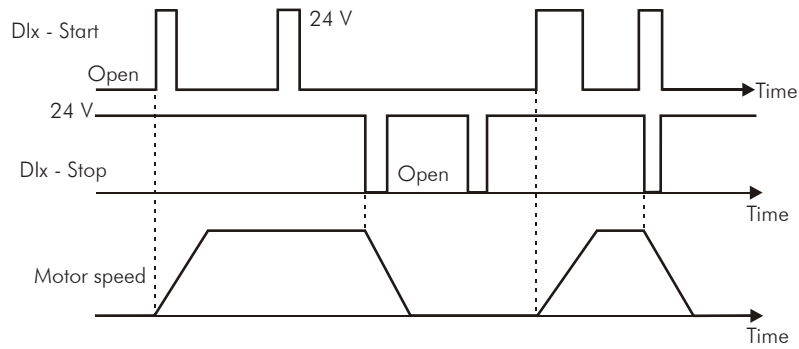

(l) FWD Run / REV Run

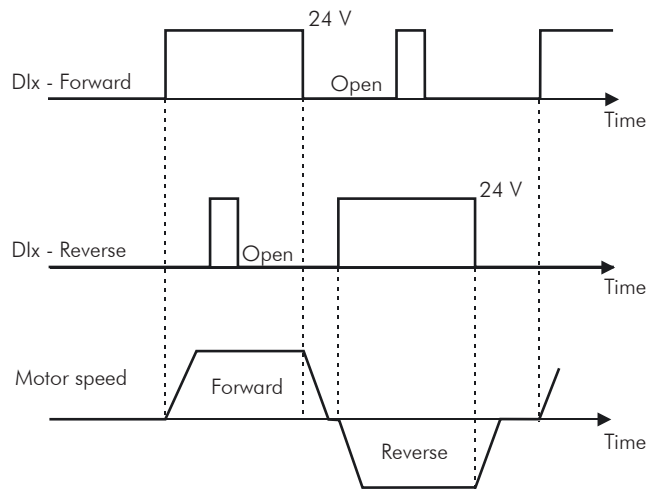

(m) ELECTRONIC POTENTIOMETER (E.P.)

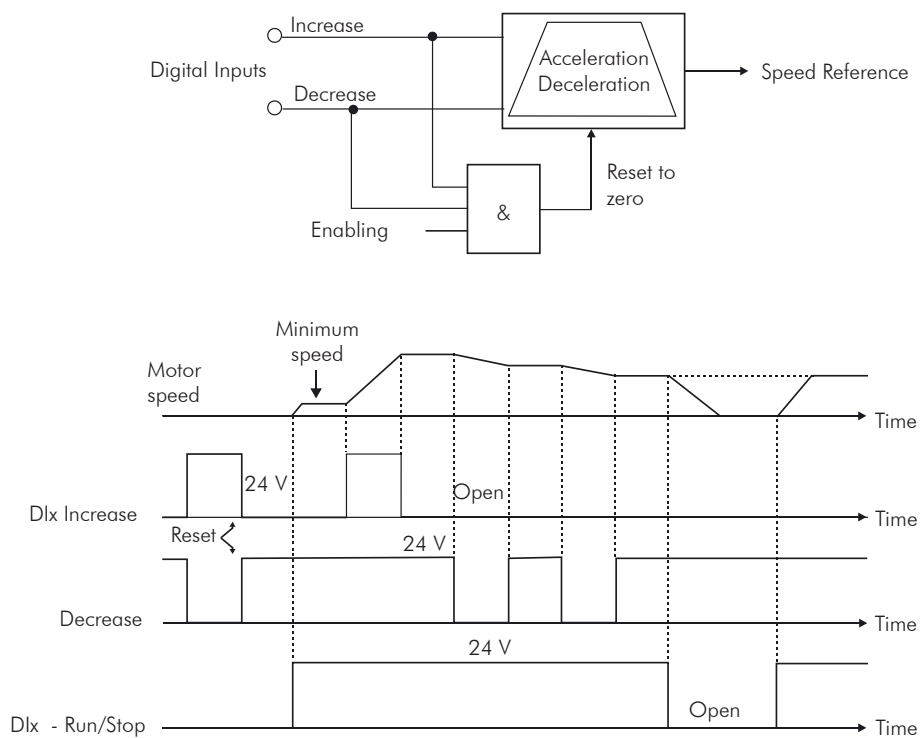

Figure 13.6 - (a) to (m) - Details on the operation of the digital input functions

13.1.4 Digital Outputs / Relays [41]

The CFW-11 has 3 relay digital outputs as standard on its control board, and 2 more digital outputs of the open collector type that can be added with the accessories IOA-01 or IOB-01. The next parameters configure the functions related to those outputs.

P0013 – DO5 to DO1 Status

Adjustable Range:	Bit 0 = DO1 Bit 1 = DO2 Bit 2 = DO3 Bit 3 = DO4 Bit 4 = DO5	Factory Setting:
Properties:	RO	
Access groups via HMI:	07 I/O CONFIGURATION 41 Digital Outputs	or 01 PARAMETER GROUPS 41 Digital Outputs

Description:

By means of this parameter it is possible to visualize the status of the control board 3 digital outputs (DO1 to DO3) and the 2 digital outputs of the optional board (DO4 and DO5).

The indication is done by means of the numbers "1" and "0", representing respectively the "Active" and "Inactive" states of the outputs. The state of each output is considered as one digit in the sequence where DO1 represents the least significant digit.

Example: In case the sequence **00010010** is presented on the keypad (HMI), it will correspond to the following status of the DOs:

Table 13.10 - Digital outputs status

DO5	DO4	DO3	DO2	DO1
Active (+24 V)	Inactive (0 V)	Inactive (0 V)	Active (+24 V)	Inactive (0 V)

13

P0273 – Filter for Torque Current - Iq

Adjustable Range:	0.00 to 9.99 s	Factory Setting:	0.00
Properties:			
Access groups via HMI:	07 I/O CONFIGURATION 41 Digital Outputs	or 01 PARAMETER GROUPS 41 Digital Outputs	

Description:

Time constant of the filter applied to the torque current. The sampling time is 2 ms.

It operates together with P0274 to activate a digital or relay output set to the Torque Polarity +/- function.

P0274 – Hysteresis for Torque Current – Iq

Adjustable Range:	0.00 to 9.99 %	Factory Setting:	2.00 %
Properties:			
Access groups via HMI:	07 I/O CONFIGURATION 41 Digital Outputs	or	01 PARAMETER GROUPS 41 Digital Outputs

Description:

It establishes the percentage of hysteresis applied to the commutation of a digital or relay output DOx when they are programmed in options 43 or 44.

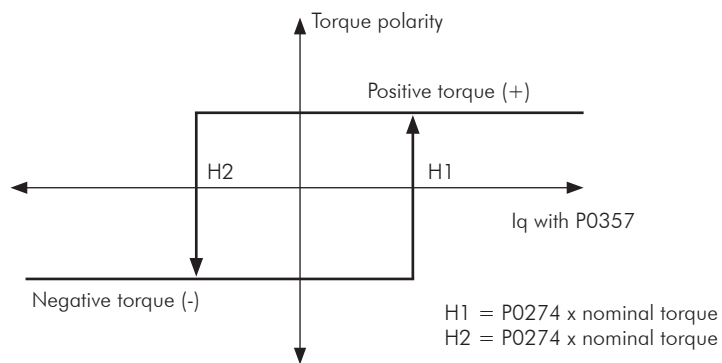

Figure 13.7 - Hysteresis for Current Torque - Iq

P0275 – DO1 Function (RL1)

P0276 – DO2 Function (RL2)

P0277 – DO3 Function (RL3)

P0278 – DO4 Function

P0279 – DO5 Function

Adjustable Range:	0 to 44	Factory Setting:	0
Properties:			
Access groups via HMI:	07 I/O CONFIGURATION 41 Digital Outputs	or	01 PARAMETER GROUPS 41 Digital Outputs

Table 13.11 - Digital output functions

Functions	P0275 (DO1)	P0276 (DO2)	P0277 (DO3)	P0278 (DO4)	P0279 (DO5)
Not Used	0 and 29	0	0	0, 29, 37, 38, 39, 40, 41 and 42	0, 29, 37, 38, 39, 40, 41 and 42
N* > Nx	1	1	1*	1	1
N > Nx	2	2*	2	2	2
N < Ny	3	3	3	3	3
N = N*	4	4	4	4	4
Zero Speed	5	5	5	5	5
Is > lx	6	6	6	6	6
Is < lx	7	7	7	7	7
Torque > Tx	8	8	8	8	8
Torque < Tx	9	9	9	9	9
Remote	10	10	10	10	10
Run	11	11	11	11	11
Ready	12	12	12	12	12
No Fault	13*	13	13	13	13
No F070	14	14	14	14	14
No F071	15	15	15	15	15
No F006/021/022	16	16	16	16	16
No F051/054/057	17	17	17	17	17
No F072	18	18	18	18	18
4-20mA Ok	19	19	19	19	19
Value P0695	20	20	20	20	20
Forward	21	21	21	21	21
Process V. > PVx	22	22	22	22	22
Process V. < PVy	23	23	23	23	23
Ride-Through	24	24	24	24	24
Pre-Charge OK	25	25	25	25	25
Fault	26	26	26	26	26
Time Enabled > Hx	27	27	27	27	27
SoftPLC	28	28	28	28	28
Timer	-	29	29	-	-
N>Nx and Nt>Nx	30	30	30	30	30
F>Fx ⁽¹⁾	31	31	31	31	31
F>Fx ⁽²⁾	32	32	32	32	32
STO	33	33	33	33	33
No F160	34	34	34	34	34
No Alarm	35	35	35	35	35
No Fault and No Alarm	36	36	36	36	36
PLC11	37	37	37	-	-
No IOE Fault	38	38	38	-	-
No IOE Alarm	39	39	39	-	-
No Broken Cable Alarm	40	40	40	-	-
No IOE Alarm and No Broken Cable Alarm	41	41	41	-	-
No IOE Fault and No Broken Cable Alarm	42	42	42	-	-
Torque +/-	43	43	43	43	43
Torque -/+	44	44	44	44	44

Description:

They program the functions of the digital outputs, according to the options presented previously.

When the condition declared by the function is true, the digital output will be activated.

Example: Is>lx function – when Is>lx then DOx = saturated transistor and/or relay with the coil energized, and when Is≤lx then DOx = open transistor and/or relay with the coil not energized.

Some notes regarding the Digital Outputs are presented next.

- **Not Used:** it means that the digital outputs will remain always in a resting state, i.e., DOx = open transistor and/or relay with the coil not energized.
- **Zero Speed:** it means that the motor speed is below the value adjusted in P0291 (Zero Speed Zone).
- **Torque > Tx and Torque < Tx:** they are valid only for P0202 = 3 or 4 (Vector Control). In those functions

"Torque" corresponds to the motor torque as indicated at parameter P0009.

- **Remote:** it means that the inverter is operating in Remote situation.
- **Run:** it corresponds to enabled inverter. In this moment the IGBTs are commutating, and the motor may be at any speed, inclusive zero.
- **Ready:** it corresponds to the inverter without fault and without undervoltage.
- **No Fault:** it means that the inverter is not disabled by any type of fault.
- **No F070:** it means that the inverter is not disabled by the F070 fault (Overcurrent or Short-circuit).
- **No F071:** it means that the inverter is not disabled by the F071 fault (Output Overcurrent).
- **No F006+F021+F022:** it means that the inverter is not disabled by the F006 fault (Line unbalance or phase loss), neither by F021 (DC Link Undervoltage), nor by F022 (DC Link Overvoltage).
- **No F051+F054+F057:** it means that the inverter is not disabled by the F051 fault (Overtemperature U Phase IGBTs), neither by F054 (Overtemperature V Phase IGBTs), nor by F057 (Overtemperature W Phase IGBTs).
- **No F072:** it means that the inverter is not disabled by the F072 fault (Motor Overload).
- **4 - 20 mA OK:** it means that the current reference (4 to 20 mA) at the analog inputs Alx is inside the 4 to 20 mA range.
- **P0695 Value:** it means that the state of the digital output will be controlled by P0695, which is written via the network. Refer to the CFW-11 Serial communication manual for more details on this parameter.
- **Forward:** it means that when the motor is rotating in the forward direction the DOx = saturated transistor and/or relay with the coil energized, and when the motor is rotating in the reverse direction, the DOx = open transistor and/or relay with the coil not energized.
- **Ride-Through:** it means that the inverter is executing the Ride-Through function.
- **Pre-charge OK:** It means that the DC Link voltage is above the pre-charge voltage level.
- **Fault:** it means that the inverter is disabled by any type of fault.
- **Timer:** those timers activate or deactivate the relay outputs 2 and 3 (Refer to the parameters P0283 to P0286 next).
- **N > Nx and Nt > Nx:** (valid only for P0202 = 4 – Vector with Encoder) it means that both the conditions must be satisfied so that DOx = saturated transistor and/or relay with the coil energized. In other words, it is enough that one of the conditions is not satisfied so that DOx = open transistor and/or relay with the coil not energized.
- **SoftPLC:** it means that the digital output state will be controlled by the programming done in the memory area reserved to the SoftPLC function. Refer to the SoftPLC manual for more details.
- **STO:** it signalizes the STO state (Safety Stop active).

- **No F160:** It signalizes that the inverter is not disabled by F160 fault (Safety Stop Relay);
- **No Alarm:** it means that the inverter is not in the alarm condition.
- **No Fault and No Alarm:** it means that the inverter is not disabled by any type of fault and it is not in alarm condition.
- **PLC11:** This option configures the signal at the DO1 (RL1), DO2 (RL2) and DO3 (RL3) outputs to be used by the PLC11.
- **No IOE Fault:** It means that the inverter is not disabled by motor high temperature fault, detected through any IOE-01, IOE-02 or IOE-03 module temperature sensor.
- **No IOE Alarm:** It means that the inverter is not in the motor high temperature alarm condition, detected through any IOE-01, IOE-02 or IOE-03 module temperature sensor.
- **No Broken Cable Alarm:** It means that the inverter is not in the broken cable alarm condition, detected at any of the IOE-01, IOE-02 or IOE-03 module temperature sensors.
- **No IOE Alarm and No Broken Cable Alarm:** It means that the inverter is not in the motor high temperature alarm condition and it is not in the broken cable alarm condition, detected at any of the IOE-01, IOE-02 or IOE-03 module temperature sensors.
- **No IOE Fault and No Broken Cable Alarm:** It means that the inverter is not disabled by motor high temperature fault and it is not in the broken cable alarm condition, detected at any of the IOE-01, IOE-02 or IOE-03 module temperature sensors.
- **Torque Polarity +/- :** The output programmed for this indication will be active while the torque is positive.
- **Torque Polarity -/+ :** The output programmed for this indication will be active while the torque is negative.



NOTE!

The outputs programmed for the Torque Polarity function have a hysteresis in their actuation that may be configured in P0274 (Hysteresis for Torque Current – Iq).

This feature actuates in the transition of those outputs at the moment they are activated or deactivated.

Description of the Torque Polarity +/- function for Torque Master/Slave

The implementation of this function requires the digital or relay outputs of the “master” CFW11 to be set to 43 (Torque Polarity +/-) or 44 (Torque Polarity -/+). This output must be connected to the digital input DIx of the “Slave” CFW11, which must be set to option 8 (Direction of Rotation).

On the master CFW11: (Vector with Encoder)	On the slave CFW11: (Vector with Encoder)
P0275, P0276, P0277, P0278 or P0279 = 43 or 44	P0100 = P0101 = 0
P0273 = 0.1 s	P0160 = 1
P0274 = 2.00 %	P0223 = P0226 = Dlx = 4
P0251 = 2	P0263, P0264, P0265, P0266, P0267, P0268, P0269 or P0270 =
P0253 = 4	Direction of Rotation = 8
	P0231 = Speed Reference = 0
	P0232 = 1.2
	P0236 = Maximum Torque Current = 2

For P275, P276, P277, P278 or P279 = 43

When the torque current of the "master" CFW11 is positive, the NC contact of output DO1, DO2, D03, D04 or DO5 will be in level zero (0 V), forcing the speed regulator of the "slave" to saturate positively, producing positive torque current.

When the torque current of the "master" CFW11 is negative, the NC contact of output DO1, DO2, D03, D04 or DO5 will be at +24 V, forcing the speed regulator of the "slave" to saturate negatively, producing negative torque current.

 **NOTE!** In case the direction of rotation of the slave motor is opposite the master motor, use option 44.

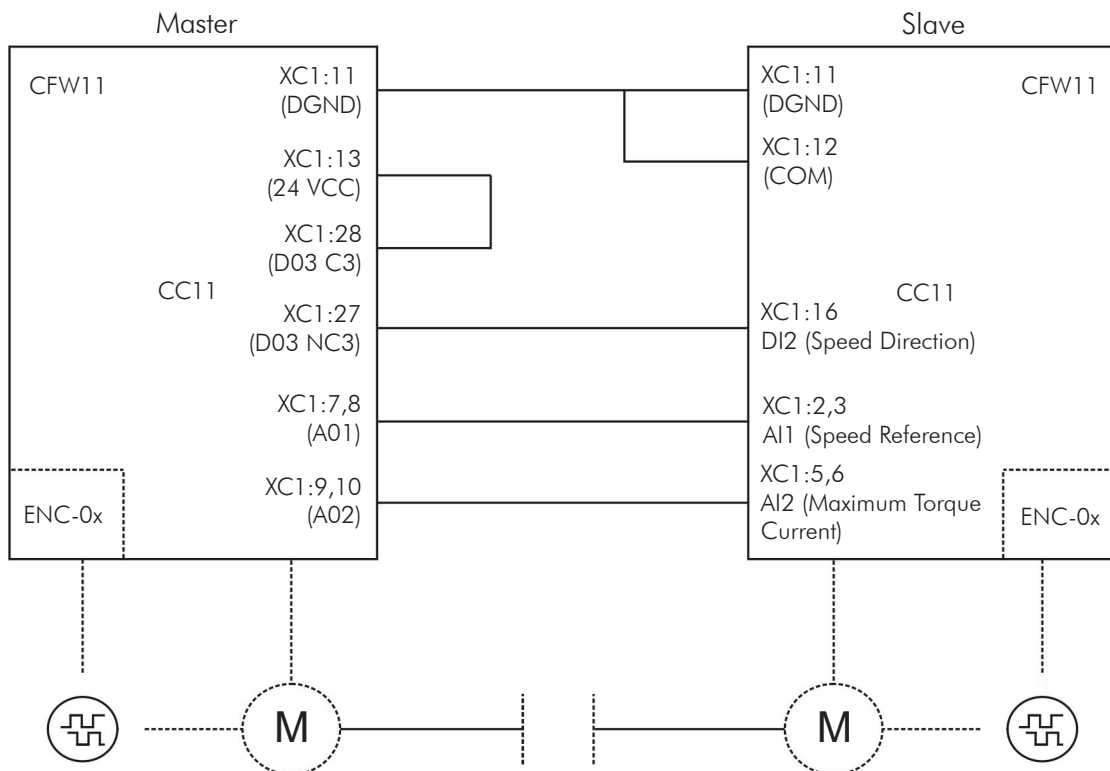

Figure 13.8 - Torque Polarity +/-

Definitions of the symbols used in the function:

N = P0002 (Motor Speed).

N* = P0001 (Speed Reference).

N_x = P0288 (N_x Speed) – It is a reference point of the speed selected by the user.

N_y = P0289 (N_y Speed) – It is a reference point of the speed selected by the user.

I_x = P0290 (I_x Current) – It is a reference point of the current selected by the user.

I_s = P0003 (Motor Current).

Torque = P0009 (Motor Torque).

T_x = P0293 (T_x Torque) – It is a reference point of the torque selected by the user.

PV_x = P0533 (PV_x Process Variable) – It is a reference point selected by the user.

PV_y = P0534 (PV_y Process Variable) – It is a reference point selected by the user.

N_t = Total Reference (refer to the [Figure 13.10 on page 13-37](#)).

H_x = P0294 (H_x Time).

F = P0005 (Motor Frequency).

F_x = P0281 (F_x Frequency) – It is a reference point of the motor frequency selected by the user.

PLC = Refer to the PLC accessory manual.

(a) $N^* > N_x$

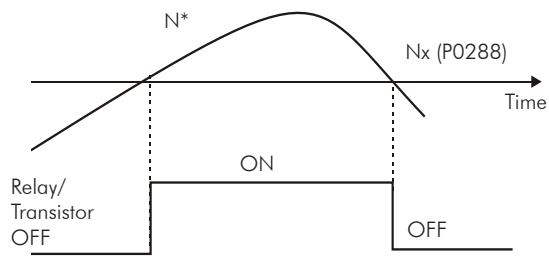

(b) $N > N_x$

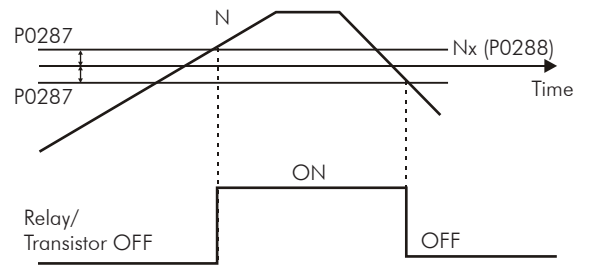

(c) $N < N_y$

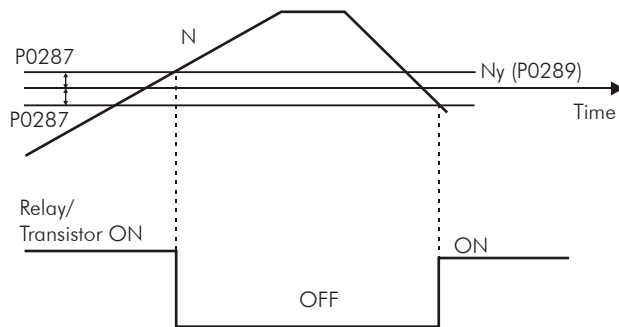

(d) $N = N^*$

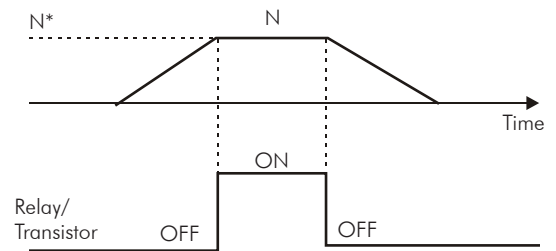

(e) $N = 0$ (Zero) Speed

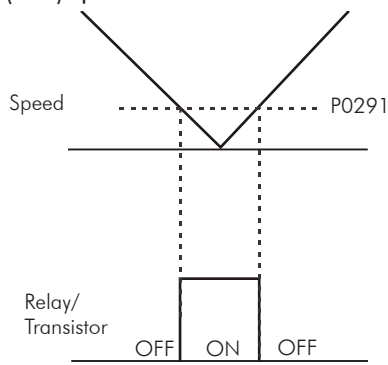

(f) $I_s > I_x$

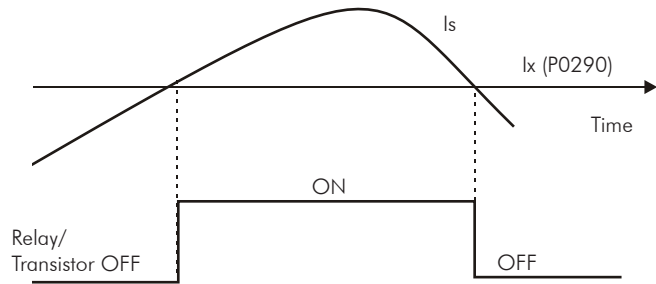

(g) $I_s < I_x$

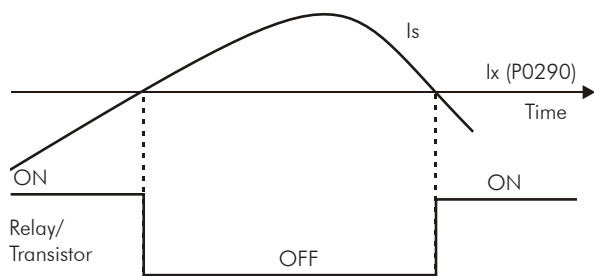

(h) Torque > T_x

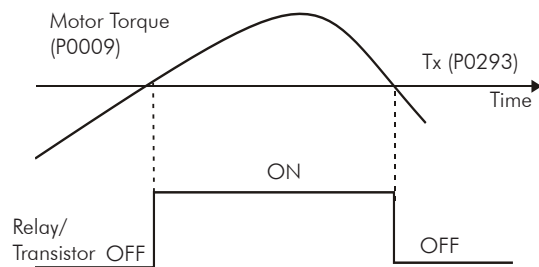

(i) Torque < T_x

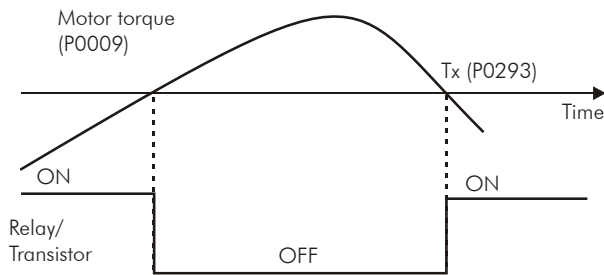

(j (a)) No fault

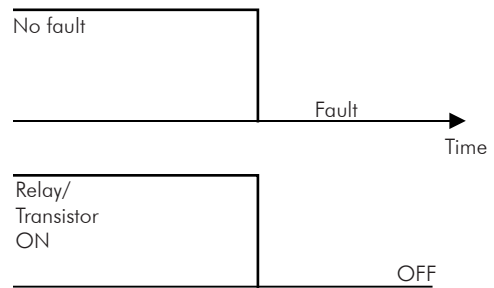

(j (b)) Fault

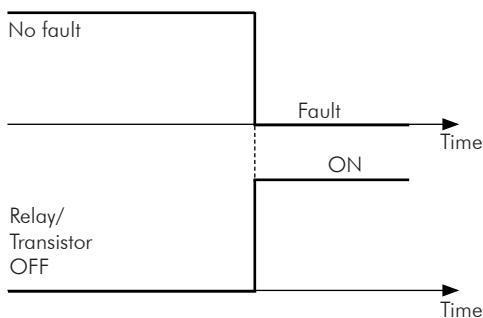

(k) 4-20 mA Reference OK

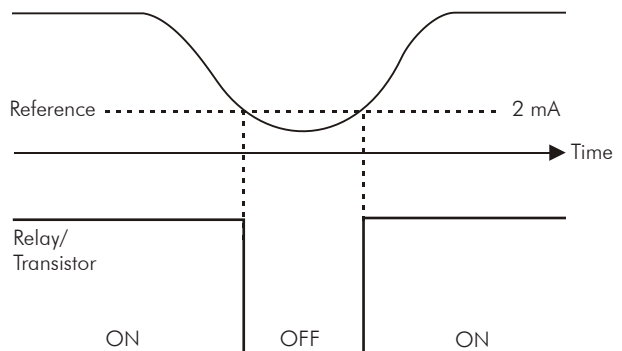

(l) Process Variable > PVx

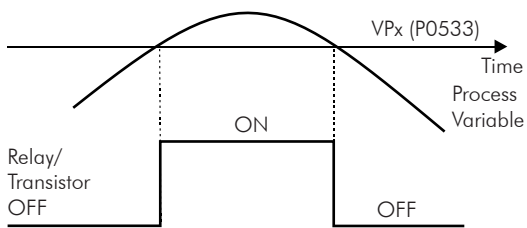

(m) Process Variable < PVy

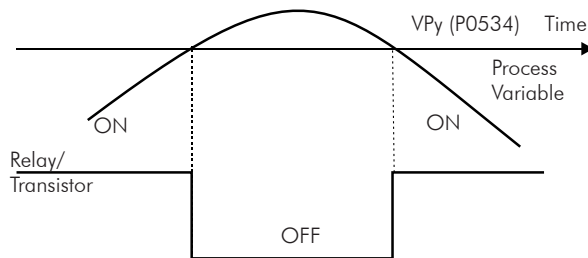

(n) Pre-Charge Ok

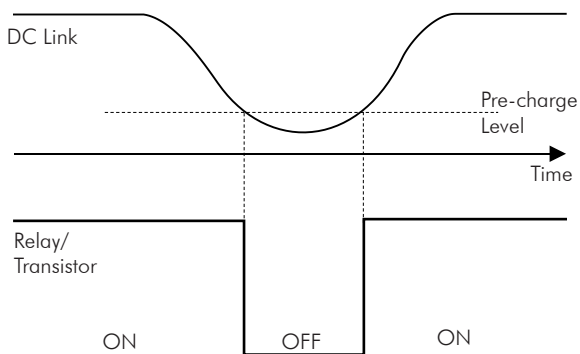

(o) Time enabled > Hx

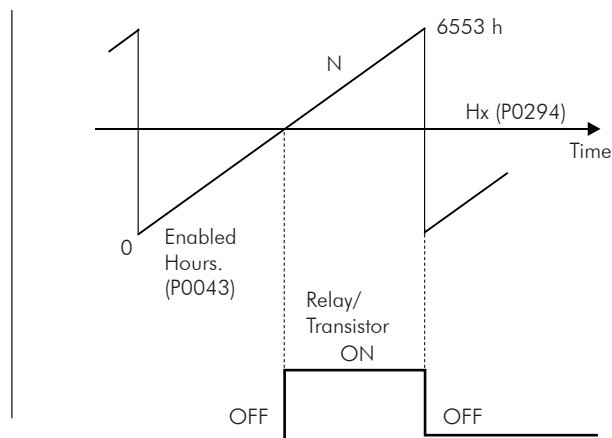

(p) N > Nx and Nt > Nx

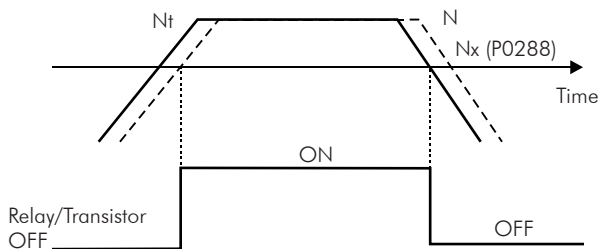

(q) F > Fx (1)

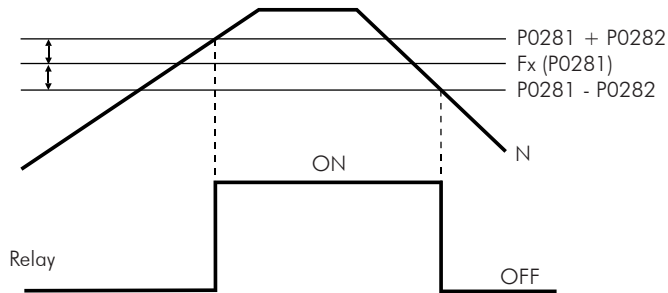

(r) F > Fx (2)

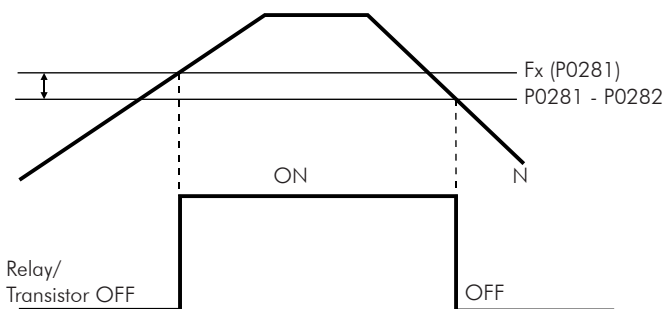

(s) No Alarm

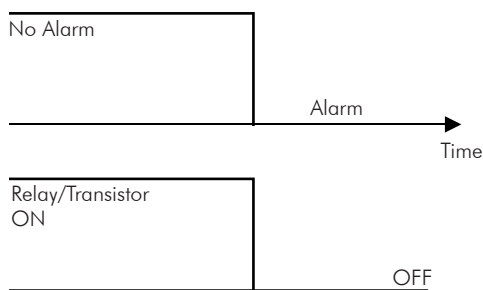

Figure 13.9 - (a) to (s) - Details on the operation of the digital output functions

P0281 – Fx Frequency

Adjustable Range:	0.0 to 300.0 Hz	Factory Setting:	4.0 Hz
Properties:			
Access groups via HMI:	07 I/O CONFIGURATION 41 Digital Outputs	or	01 PARAMETER GROUPS 41 Digital Outputs

Description:
It is used in the digital output and relay functions:

F > Fx⁽¹⁾ and F > Fx⁽²⁾

P0282 – Fx Hysteresis

Adjustable Range:	0.0 to 15.0 Hz	Factory Setting:	2.0 Hz
Properties:			
Access groups via HMI:	07 I/O CONFIGURATION 41 Digital Outputs	or	01 PARAMETER GROUPS 41 Digital Outputs

Description:
It is used in the digital output and relay functions:

F > Fx⁽¹⁾ and F > Fx⁽²⁾

P0283 – DO2 On Time

P0284 – DO2 Off Time

P0285 – DO3 On Time

P0286 – DO3 Off Time

Adjustable Range:	0.0 to 300.0 s	Factory Setting:	0.0 s
Properties:			
Access groups via HMI:	07 I/O CONFIGURATION 41 Digital Outputs	or	01 PARAMETER GROUPS 41 Digital Outputs

Description:
Those parameters are used in relay outputs 2 and 3 **Timer** functions, they adjust the time for the activation or deactivation of the relay after a transition of the digital input programmed for this function, as detailed in the parameters of the previous section.

Thus, after a DIx transition for activating or deactivating the programmed relay, it is necessary that this DIx remains in On/Off for at least the time adjusted in the parameters P0283/P0285 and P0284/P0286. Otherwise the timer will be reset. Refer to the [Figure 13.5 on page 13-16](#).

P0287 – Hysteresis for Nx and Ny

Adjustable Range:	0 to 900 rpm	Factory Setting:	18 rpm (15 rpm)
Properties:			
Access groups via HMI:	07 I/O CONFIGURATION 41 Digital Outputs	or	01 PARAMETER GROUPS 41 Digital Outputs

Description:

It is used in the $N > N_x$ and $N < N_y$ functions of the digital and relay outputs.

P0288 – Nx Speed

Adjustable Range:	0 to 18000 rpm	Factory Setting:	120 rpm (100 rpm)
--------------------------	----------------	-------------------------	----------------------

P0289 – Ny Speed

Adjustable Range:	0 to 18000 rpm	Factory Setting:	1800 rpm (1500 rpm)
Properties:			
Access groups via HMI:	07 I/O CONFIGURATION 41 Digital Outputs	or	01 PARAMETER GROUPS 41 Digital Outputs

Description:

They are used in the $N^* > N_x$, $N > N_x$, and $N < N_y$ functions of the digital and relay outputs.

P0290 – Ix Current

Adjustable Range:	0 to $2 \times I_{nom-ND}$	Factory Setting:	$1.0 \times I_{nom-ND}$
Properties:			
Access groups via HMI:	07 I/O CONFIGURATION 41 Digital Outputs	or	01 PARAMETER GROUPS 41 Digital Outputs

Description:

It is used in the $I_s > I_x$ and $I_x < I_x$ functions of the digital and relay outputs.

P0291 – Zero Speed Zone

Adjustable Range:	0 to 18000 rpm	Factory Setting:	18 rpm (15 rpm)
Properties:			
Access groups via HMI:	07 I/O CONFIGURATION 35 Zero Speed Logic	or	01 PARAMETER GROUPS 41 Digital Outputs

Description:

It specifies the value in rpm, $\pm 1\%$ of the motor rated speed (hysteresis), below which the actual speed will be considered null for the Zero Speed Disable function.

This parameter is also used by the functions of the digital and relay outputs, and by the PID regulator. The hysteresis is $\pm 0.22\%$ of the motor rated speed.

P0292 – N = N* Band

Adjustable Range:	0 to 18000 rpm	Factory Setting:	18 rpm (15 rpm)
Properties:			
Access groups via HMI:	07 I/O CONFIGURATION └─ 41 Digital Outputs	or	01 PARAMETER GROUPS └─ 41 Digital Outputs

Description:

It is used in the **N = N*** function of the digital and relay outputs.

P0293 – Tx Torque

Adjustable Range:	0 to 200 %	Factory Setting:	100 %
Properties:			
Access groups via HMI:	07 I/O CONFIGURATION └─ 41 Digital Outputs	or	01 PARAMETER GROUPS └─ 41 Digital Outputs

Description:

It is used in the **Torque > Tx** and **Torque < Tx** functions of the digital and relay outputs.

In those functions the motor torque indicated in P0009 is compared with the value adjusted in P0293.

The setting of this parameter is expressed as a percentage of the motor rated current (P0401 = 100 %).

P0294 – Hx Time

Adjustable Range:	0 to 6553 h	Factory Setting:	4320 h
Properties:			
Access groups via HMI:	07 I/O CONFIGURATION └─ 41 Digital Outputs	or	01 PARAMETER GROUPS └─ 41 Digital Outputs

Description:

It is used in the **Enabled Hours > Hx** function of the digital and relay outputs.

13.2 LOCAL AND REMOTE COMMAND

In those parameter groups one can configure the origin of the main inverter commands when in the LOCAL or in the REMOTE situation, as the Speed Reference, Speed Direction, Run/Stop and JOG.

P0220 – LOCAL/REMOTE Selection Source

Adjustable Range:	0 = Always LOCAL 1 = Always REMOTE 2 = Local/Remote Key LOCAL 3 = Local/Remote Key REMOTE 4 = Dlx 5 = Serial/USB LOCAL 6 = Serial/USB REMOTE 7 = Anybus-CC LOCAL 8 = Anybus-CC REMOTE 9 = CANopen/DeviceNet/Profibus DP LOCAL 10 = CANopen/DeviceNet/Profibus DP REMOTE 11 = SoftPLC LOCAL 12 = SoftPLC REMOTE 13 = PLC11 LOCAL 14 = PLC11 REMOTE	Factory Setting:	2
Properties:	CFG		
Access groups via HMI:	01 PARAMETER GROUPS 31 Local Command	or	01 PARAMETER GROUPS 32 Remote Command

Description:

It defines the origin of the command that will select between the LOCAL situation and the REMOTE situation, where:

- LOCAL: Means Local Default situation.
- REMOTE: Means Remote Default situation.
- Dlx: Refer to the [Item 13.1.3 Digital Inputs \[40\]](#) on page 13-12.

P0221 – Speed Reference Selection – LOCAL Situation



P0222 – Speed Reference Selection – REMOTE Situation

Adjustable Range:	0 = HMI 1 = AI1 2 = AI2 3 = AI3 4 = AI4 5 = AI1 + AI2 > 0 (Sum AIs > 0) 6 = AI1 + AI2 (Sum AIs) 7 = E.P. 8 = Multispeed 9 = Serial/USB 10 = Anybus-CC 11 = CANopen/DeviceNet/Profibus DP 12 = SoftPLC 13 = PLC11	Factory Setting:	P0221 = 0 P0222 = 1
Properties:	CFG		
Access groups via HMI:	01 PARAMETER GROUPS 31 Local Command	or	01 PARAMETER GROUPS 32 Local Command

Description:

They define the origin of the Speed Reference in the LOCAL situation and in the REMOTE situation.

Some notes about the options for those parameters:

- The Alx' designation refers to the analog signal obtained after the addition of the Alx input to the offset and its multiplication by the applied gain (refer to the [Item 13.1.1 Analog Inputs \[38\]](#) on page 13-1).
- The value of the reference adjusted with the  and  is contained in the parameter P0121.
- When the option 7 is selected (E.P), one of the digital inputs must be programmed at 11 (Increase E.P) and another at 12 (Decrease E.P). Refer to the [Section 12.5 ELECTRONIC POTENTIOMETER \[37\]](#) on page 12-9, for more details.
- When the option 8 is selected, P0266 and/or P0267 and/or P0268 must be programmed at 13 (Multispeed). Refer to the [Section 12.4 MULTISPEED \[36\]](#) on page 12-7.
- When P0203 = 1 (PID Regulator), do not use the reference via E.P.
- When P0203 = 1, the value programmed in P0221/P022 becomes the PID Setpoint.

P0223 – FORWARD/REVERSE Selection - LOCAL Situation

P0226 – FORWARD/REVERSE Selection - REMOTE Situation

Adjustable Range:	0 = Always FORWARD 1 = Always REVERSE 2 = Forward/Reverse Key (FWD) 3 = Forward/Reverse Key (REV) 4 = Dlx 5 = Serial/USB (FWD) 6 = Serial/USB (REV) 7 = Anybus-CC (FWD) 8 = Anybus-CC (REV) 9 = CANopen/DeviceNet/Profibus DP (FWD) 10 = CANopen/DeviceNet/Profibus (REV) 11 = AI4 Polarity 12 = SoftPLC (FWD) 13 = SoftPLC (REV) 14 = AI2 Polarity 15 = PLC11 FORWARD 16 = PLC11 REVERSE	Factory Setting: P0223 = 2 P0226 = 4
Properties:	CFG, V/f, VVW and Vector	
Access groups via HMI:	01 PARAMETER GROUPS └─ 31 Local Command	or 01 PARAMETER GROUPS └─ 32 Remote Command



Description:

They define the origin of the "Speed Direction" command in the LOCAL situation and in the REMOTE situation, where:

- FWD: Means Forward Default situation.
- REV: Means Reverse Default situation.
- Dlx: Refer to the [Item 13.1.3 Digital Inputs \[40\]](#) on page 13-12.

P0224 – Run/Stop Selection – LOCAL Situation

P0227 – Run/Stop Selection - REMOTE Situation

Adjustable Range:	0 = Keys  , 	Factory Setting: P0224 = 0 P0227 = 1	
	1 = DIx 2 = Serial/USB 3 = Anybus-CC 4 = CANopen/DeviceNet/Profibus DP 5 = SoftPLC 6 = PLC11		
Properties:	CFG		
Access groups via HMI:	01 PARAMETER GROUPS	or	01 PARAMETER GROUPS
	31 Local Command		32 Remote Command

Description:

They define the origin of the Run/Stop command in the LOCAL situation and in the REMOTE situation.

P0225 – JOG Selection – LOCAL Situation

P0228 – JOG Selection - REMOTE Situation

Adjustable Range:	0 = Disabled 1 = JOG Key 2 = DIx 3 = Serial/USB 4 = Anybus-CC 5 = CANopen/DeviceNet/Profibus DP 6 = SoftPLC 7 = PLC11	Factory Setting: P0225 = 1 P0228 = 2	
Properties:	CFG		
Access groups via HMI:	01 PARAMETER GROUPS	or	01 PARAMETER GROUPS
	31 Local Command		32 Remote Command

Description:

They define the origin of the JOG command in the LOCAL situation and in the REMOTE situation.

P0229 – Stop Mode Selection

Adjustable Range:	0 = Ramp to Stop 1 = Coast to Stop 2 = Fast Stop 3 = By Ramp with Iq* 4 = Fast Stop with Iq*	Factory Setting: 0
Properties:	CFG	
Access groups via HMI:	01 PARAMETER GROUPS 31 Local Command	or 01 PARAMETER GROUPS 32 Remote Command

Description:

It defines the motor stop mode when the inverter receives the "Stop" command. The [Table 13.12 on page 13-36](#) describes the options of this parameter.

Table 13.12 - Stop mode selection

P0229	Description
0 = Ramp to Stop	The inverter will apply the ramp programmed in P0101 and/or P0103
1 = Coast to Stop	The motor will run free until stopping
2 = Fast Stop	The inverter will apply a null ramp (time = 0.0 second), in order to stop the motor in the shortest possible time
3 = By Ramp with Iq* reset	The inverter will apply the deceleration ramp programmed in P0101 or P0103, and will reset the torque current reference
4 = Fast Stop with Iq* reset	The inverter will apply a null ramp (time = 0.0 second), in order to stop the motor in the shortest possible time, and will reset the torque current reference

 **NOTE!** When the control modes V/f or VVW are selected, the use of the option 2 (Fast Stop) is not recommended.

 **NOTE!** When the Coast to Stop, stop mode, is programmed and the Flying-Start function is not enabled, then start the motor again only if it is standing still.

 **NOTE!** Options 3 and 4 will operate only with P0202 = 4 or P0202 = 6. The difference in behavior, compared to the options 0 and 2, is in the torque current reference (Iq*) reset. This reset occurs during the inverter state transition from Run to Ready, after executing a Stop command. The purpose of the options 3 and 4 is to avoid that a high current reference value is stored in the speed regulator when, for instance, using a mechanical brake to stop the motor shaft before its speed is null.

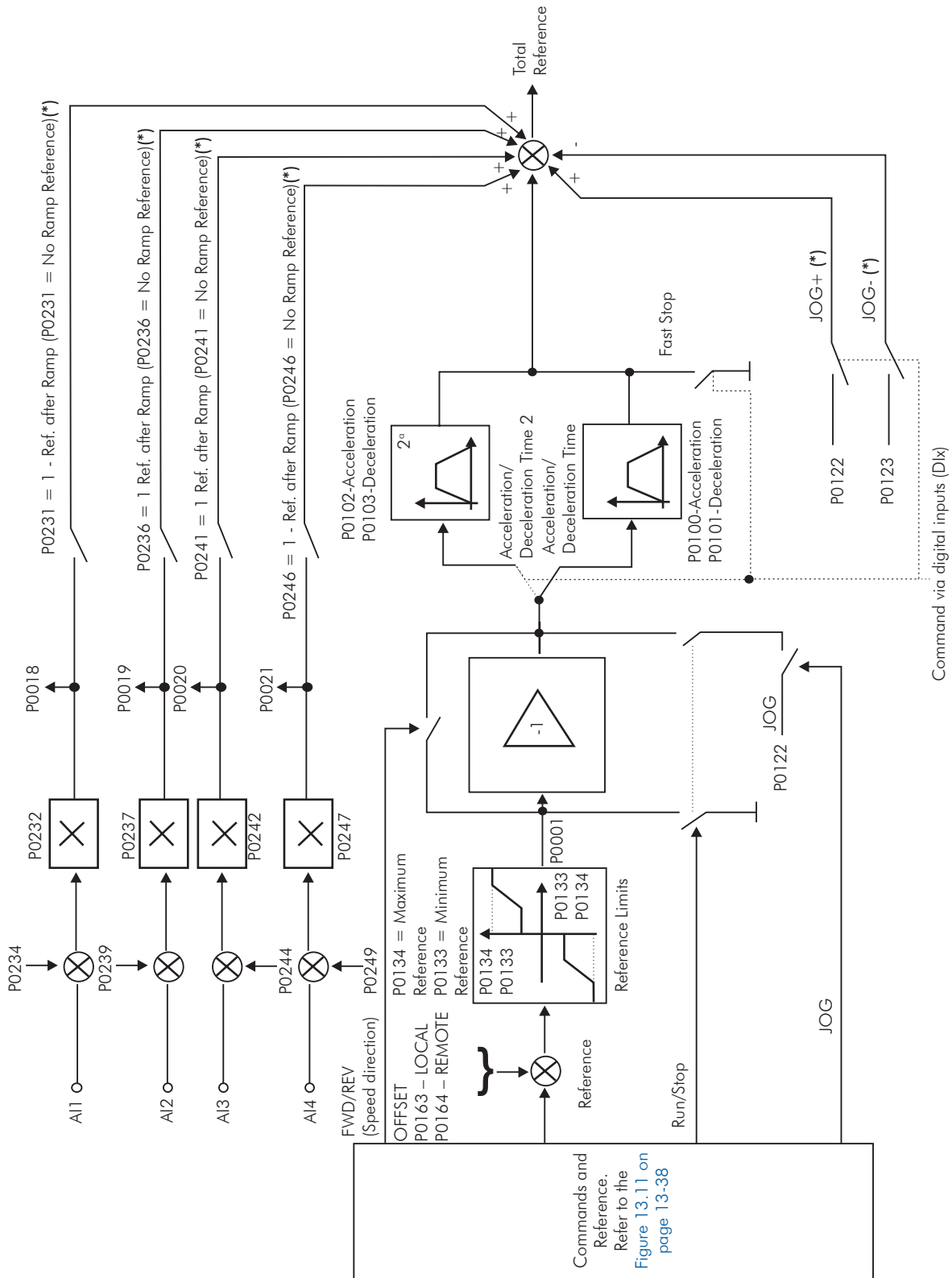

(*) Valid only for P0202 = 3 and 4.

Figure 13.10 - Speed Reference block diagram

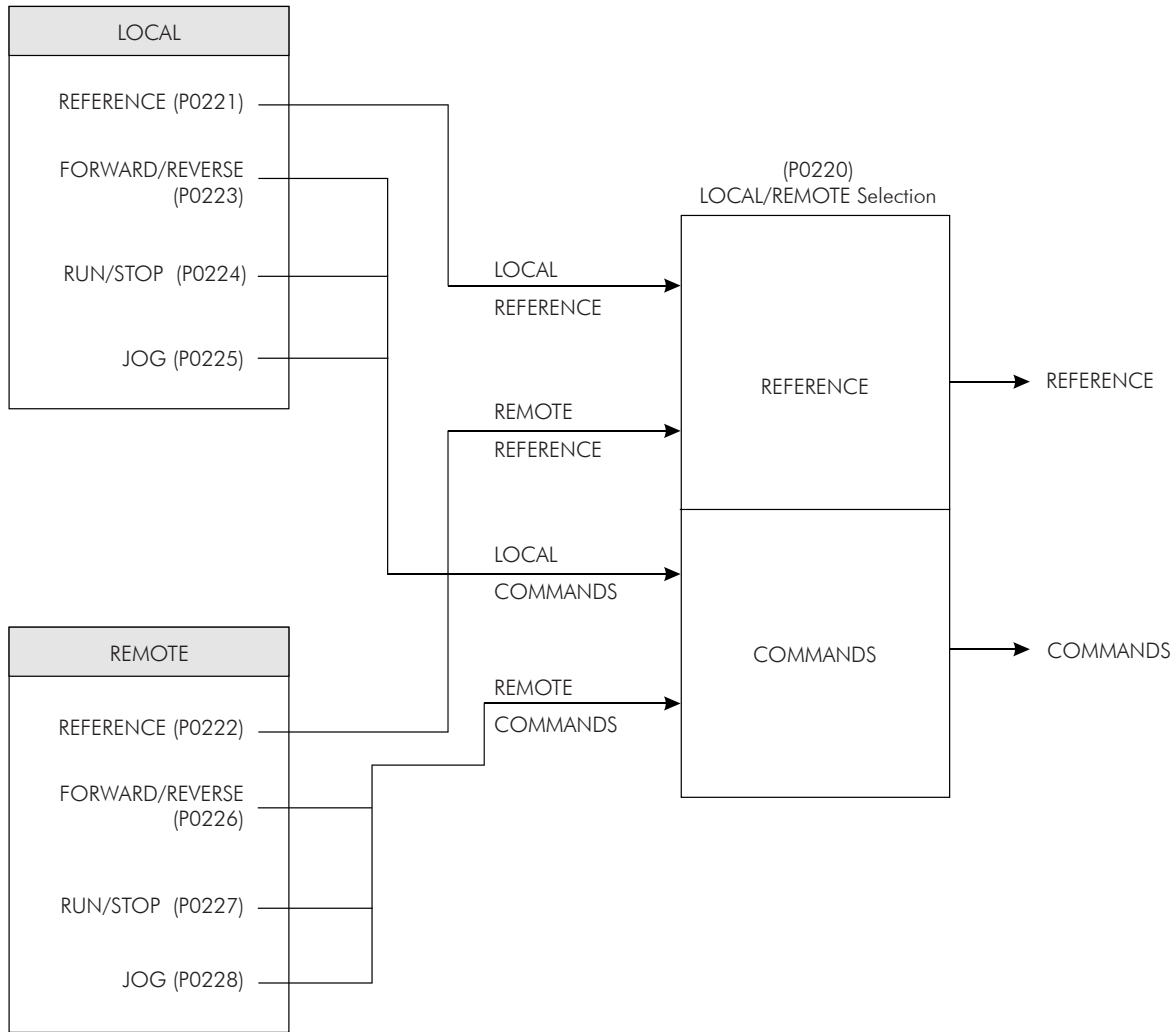

Figure 13.11 - Local/Remote situation block diagram

13

13.3 3-WIRE COMMAND [33]

The group defined as "3-Wire Command" refers to the function Run/Stop programmed via digital inputs.

With this function it is possible to activate or deactivate the motor by means of pulses at the digital inputs configured as Run (Dlx = 6) and Stop (Dlx = 7). It is important to notice that the Stop pulse is inverted, i.e., a transition from +24 V to 0 V.

For a better understanding of this function it is recommended to verify the [Figure 13.6 on page 13-19 \(k\)](#).

13.4 FORWARD RUN/REVERSE RUN COMMANDS [34]

The FWD Run/REV Run function can be used to command the motor in the forward direction and in the reverse direction by means of digital inputs.

With the application of +24 V to the input programmed for FWD Run (Dlx = 4), the motor accelerates in the forward direction until reaching the speed reference. Once the FWD Run input has been released (0 V) and +24 V has been applied at the input programmed for REV Run (Dlx = 5), the CFW-11 will activate the motor in the reverse direction until it reaches the speed reference. Refer to the [Figure 13.6 on page 13-19 \(l\)](#).

14 DYNAMIC BRAKING

The braking torque that can be obtained through the application of frequency inverters without dynamic braking resistors varies from 10 % to 35 % of the motor rated torque.

In order to obtain higher braking torques, resistors for dynamic braking are used. In this case the regenerated energy is dissipated on the resistor mounted externally to the inverter.

This type of braking is used in the cases when short deceleration times are wished or when high inertia loads are driven.

For the vector control mode there is the possibility of the use of the "Optimal Braking", eliminating in many cases the need of the dynamic braking.

14.1 DYNAMIC BRAKING [28]



NOTE!

This function is not available in inverters with frames F and G.

The Dynamic Braking function can only be used if a braking resistor has been connected to the CFW-11, and if the parameters related to it have been adjusted properly.

See next the description of the parameters in order to know how to program each one.

P0153 – Dynamic Braking Level

Adjustable Range:	339 to 400 V	Factory Setting:	375 V (P0296 = 0)
	585 to 800 V		618 V (P0296 = 1)
	585 to 800 V		675 V (P0296 = 2)
	585 to 800 V		748 V (P0296 = 3)
	585 to 800 V		780 V (P0296 = 4)
	809 to 1000 V		893 V (P0296 = 5)
	809 to 1000 V		972 V (P0296 = 6)
	924 to 1200 V		972 V (P0296 = 7)
	924 to 1200 V		1174 V (P0296 = 8)
Properties:			
Access groups via HMI:	01 PARAMETER GROUPS		
	28 Dynamic Braking		

Description:

The parameter P0153 defines the voltage level for the braking IGBT actuation, and it must be compatible with the power supply voltage.

If P0153 is adjusted at a level very close to the overvoltage (F022) actuation level, the fault may occur before the Braking resistor is able to dissipate the regenerated energy.

The next table presents the overvoltage trip level.

Table 14.1 - Overvoltage (F022) trip levels

Inverter V _{nom}	P0296	F022
220/230 V	0	> 400 V
380 V	1	> 800 V
400/415 V	2	
440/460 V	3	
480 V	4	
500/525 V	5	> 1000 V
550/575 V	6	
600 V	7	
660/690 V	8	> 1200 V

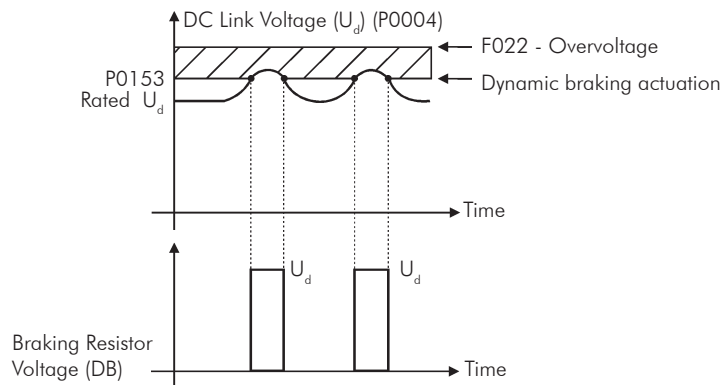

Figure 14.1 - Dynamic Braking actuation curve

Steps to enable the dynamic braking:

- Connect the braking resistor (Refer to the item 3.2.3.2 - Dynamic Braking, of the user's manual).
- Set P0154 and P0155 according to the used braking resistor.
- Set P0151 or P0185 at the maximum value: 400 V (P0296 = 0), 800 V (P0296 = 1, 2, 3 or 4), 1000 V (P0296 = 5, 6 or 7) or 1200 V (P0296 = 8), according to the case, in order to prevent the activation of the DC voltage regulation before the dynamic braking.

P0154 – Dynamic Braking Resistor

Adjustable Range: 0.0 to 500.0 ohm **Factory Setting:** 0.0 ohm

Properties:

Access groups via HMI: 01 PARAMETER GROUPS
28 Dynamic Braking

Description:

Adjust this parameter with the ohmic value of the used braking resistor.

If P0154 = 0, the braking resistor overload protection is disabled. It must be programmed in zero if no braking resistor is used.

P0155 – Dynamic Braking Resistor Power

Adjustable Range:	0.02 to 650.00 kW	Factory Setting:	2.60 kW
Properties:			
Access groups via HMI:	<div style="border: 1px solid black; padding: 2px; display: inline-block;">01 PARAMETER GROUPS</div> <div style="border: 1px solid black; padding: 2px; display: inline-block; margin-left: 20px;">28 Dynamic Braking</div>		

Description:

This parameter adjusts the trip level of the braking resistor overload protection.

It must be set according to the used braking resistor rated power (in kW).

Operation: if the average power dissipated on the braking resistor exceeds the value adjusted in P0155 for 2 minutes, the inverter will be disabled with F077 – DB Resistor Overload.

In order to get more details on the selection of the braking resistor, refer to the item 3.2.3.2 - Dynamic Braking, of the user's manual.

15 FAULTS AND ALARMS

The troubleshooting structure of the inverter is based on the indication of faults and alarms.

In a fault event the IGBTs firing pulses are disabled and the motor coasts to stop.

The alarm works as a warning to the user that critical operation conditions are occurring and a fault may occur if the situation does not change.

Refer to the CFW-11 user's manual chapter 6 - Troubleshooting and Maintenance and the chapter Quick Parameter Reference, Faults and Alarms of this manual to obtain more information regarding the Faults and Alarms.

15.1 MOTOR OVERLOAD PROTECTION

The Motor Overload protection is based on the use of curves that simulate the heating and cooling of the motor in overload events, according to IEC 60947-4-2 and UL 508C standards. The fault and alarm codes for the motor overload protection are F072 and A046, respectively.

The motor overload is given in function of the reference value $I_n \times SF$ (motor rated current multiplied by the service factor), which is the maximum value at which the protection must not actuate because the motor is able to operate indefinitely with this current value without suffering damages.

However, for that protection to act in an appropriate manner, the thermal image of the motor, which corresponds to the heating up and cooling down times of the motor, is estimated.

The thermal image, in its turn, depends on the motor thermal constant, which is estimated based on the motor power and number of poles.

The thermal image is important to allow that a derating in the fault actuation time be given, so that shorter actuation times be obtained when the motor is hot.

This function applies a derating in the fault actuation time depending on the output frequency supplied to the motor, because for the self-ventilated ones there will be less ventilation on the frame at lower speeds, and the motor will be subject to more heating. Thus, it becomes necessary to reduce the fault actuation time in order to prevent the motor from burning.

In order to assure more protection in case of restart, this function keeps the information regarding the motor thermal image in the CFW-11 nonvolatile memory (EEPROM). Therefore, after the inverter restart, the function will use the value saved in the thermal memory to perform a new overload evaluation.

The parameter P0348 configures the desired protection level for the motor overload function. The possible options are: Fault and Alarm, only Fault, only Alarm, and disabled motor overload protection. The actuation level for the motor overload alarm (A046) is adjusted via P0349.

In order to get more information, refer to parameters P0156, P0157, P0158, P0159, P0348 and P0349 in the [Section 15.3 PROTECTIONS \[45\] on page 15-4](#).



NOTE!

In order to assure the conformity of the CFW-11 motor overload protection with the UL508C standard, observe the following:

- ☑ The "TRIP" current is equal to 1.25 times the motor nominal current (P0401) adjust in the "Oriented Start-up" menu.
- ☑ The maximum allowed value for P0398 (Motor Service Factor) is 1.15.
- ☑ Parameters P0156, P0157 and P0158 (Overload Current at 100 %, 50 % and 5 % of the rated speed, respectively) are automatically adjusted when the parameter P0401 (Motor Rated Current) and/or P0406 (Motor Ventilation) are adjusted in the "Oriented Start-up" menu. If the parameters P0156, P0157 and P0158 are manually adjusted, the maximum allowed value for those parameters is 1.05 x P0401.

15.2 MOTOR OVERTEMPERATURE PROTECTION



ATTENTION!

The PTC must have a reinforced insulation against the live parts of the motor and of the installation.

This protection performs the motor overtemperature protection by means of the alarm (A110) and the fault (F078) indication.

The motor must have a PTC type temperature sensor.

An analog output supplies constant current for the PTC (2 mA), while an inverter analog input reads the voltage across the PTC and compares it with the limit values for fault and alarm. Refer to the [Table 15.1 on page 15-2](#). When those values are exceeded, the alarm or fault indication occurs.

The analog outputs AO1 and AO2 of the control module, as well as the analog outputs existent on the accessory modules AO1-B and AO2-B (IOB) can be used to supply the constant current for the PTC. Therefore it is necessary to configure the DIP switches of the output for current and to set the output function parameter for 13 = PTC.

The analog inputs AI1 and AI2 of the control module, as well as the analog inputs existent on the accessory modules AI3 (IOB) and AI4 (IOA) can be used to read the PTC voltage. Therefore it is necessary to configure the input DIP switch for voltage and to set the input function parameter for 4 = PTC. Refer to the parameter P0351 on the [Section 15.3 PROTECTIONS \[45\] on page 15-4](#).



NOTA!

In order that this function works properly, it is important to keep gains and offset of the analog input and output in the default values.

Table 15.1 - A110 and F078 trip levels

Action	PTC	AI voltage
A110 occurs during the temperature increase	$R_{PTC} > 3.51 \text{ k}\Omega$	$V_{AI} > 7.0 \text{ V}$
F078 trips during the temperature increase	$R_{PTC} > 3.9 \text{ k}\Omega$	$V_{AI} > 7.8 \text{ V}$
Resets A110 alarm	$150 \Omega < R_{PTC} < 1.6 \text{ k}\Omega$	$0.3 < V_{AI} < 3.2 \text{ V}$
Allows the reset of the F078 fault	$150 \Omega < R_{PTC} < 1.6 \text{ k}\Omega$	$0.3 < V_{AI} < 3.2 \text{ V}$
F078 trips (minimum resistance detection)	$R_{PTC} < 60 \Omega$	$< 0.12 \text{ V}$

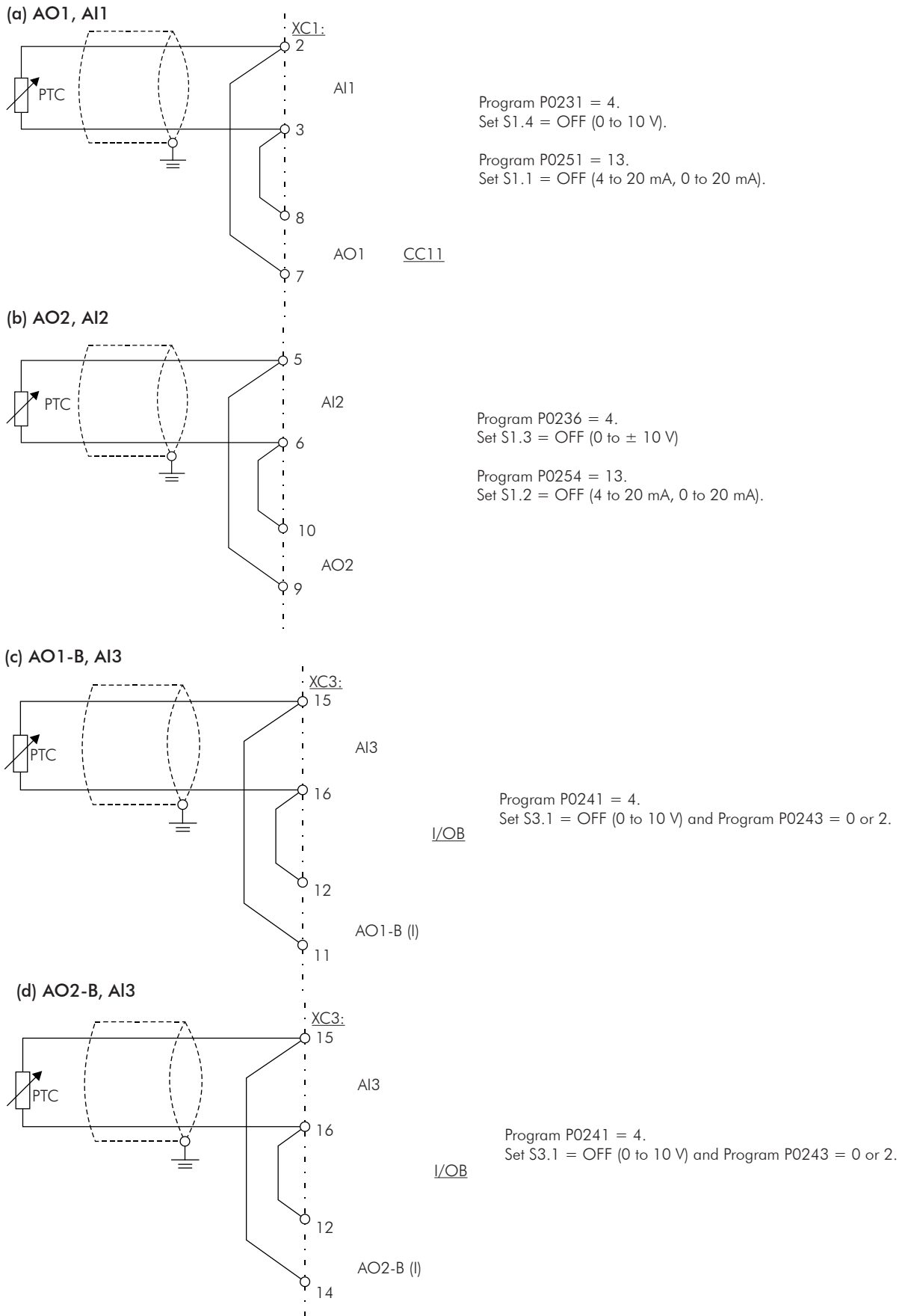

Figure 15.1 - (a) to (d) - PTC connection examples

15.3 PROTECTIONS [45]

The parameters related to motor and inverter protections are found in this group.

P0030 – U Arm IGBT Temperature

P0031 – V Arm IGBT Temperature

P0032 – W Arm IGBT Temperature

P0033 – Rectifier Temperature

P0034 – Internal Air Temperature

Adjustable Range:	-20.0 to 150.0 °C	Factory Setting:
Properties:	RO	
Access groups via HMI:	01 PARAMETER GROUPS 45 Protections	

Description:

These parameters present, in Celsius degrees, the heatsink temperature on the U, V and W arms (P0030, P0031 and P0032), of the rectifier (P0033), and also of the internal air (P0034).

They are useful to monitor the temperature on the main inverter sections in case of an occasional inverter overheating.

P0156 – Motor Overload Current at 100 % of its Rated Speed

P0157 – Motor Overload Current at 50 % of its Rated Speed

P0158 – Motor Overload Current at 5 % of its Rated Speed

Adjustable Range:	0.1 to 1.5 x I _{nom-ND}	Factory Setting:	P0156 = 1.05 x P0401 P0157 = 0.9 x P0401 P0158 = 0.65 x P0401
Properties:			
Access groups via HMI:	01 PARAMETER GROUPS 45 Protections		

Description:

These parameters are used for the motor overload protection (I x t – F072).

The motor overload current (P0156, P0157 and P0158) is the value from which the inverter starts considering that the motor is operating with overload.

The bigger the difference between the motor current and the overload current, the faster F072 trip will occur.

When P0202 = 6 or 7 (Sensorless Vector Control or Vector Control with Encoder, both for PM motor) and P0406 = 0 (Self-ventilated Motor), the parameters P0156, P0157 and P0158 must be adjusted 5 % higher than the motor rated current (P0401).

The parameters P0156, P0157 and P0158 are adjusted automatically when P0401 (Motor Rated Current), P0406 (Motor Ventilation Type) or P0298 (Inverter Application) are set during the "Oriented Start-up" routine (refer to this parameter description in the section 11.7 – Motor Data of CFW-11 Programming Manual V3.1X).

The overload current is given as a function of the speed being applied to the motor, according to the overload curve. The parameter P0156, P0157 and P0158 are the three points used to form the motor overload curve, as presented in the [Figure 15.2 on page 15-5](#).

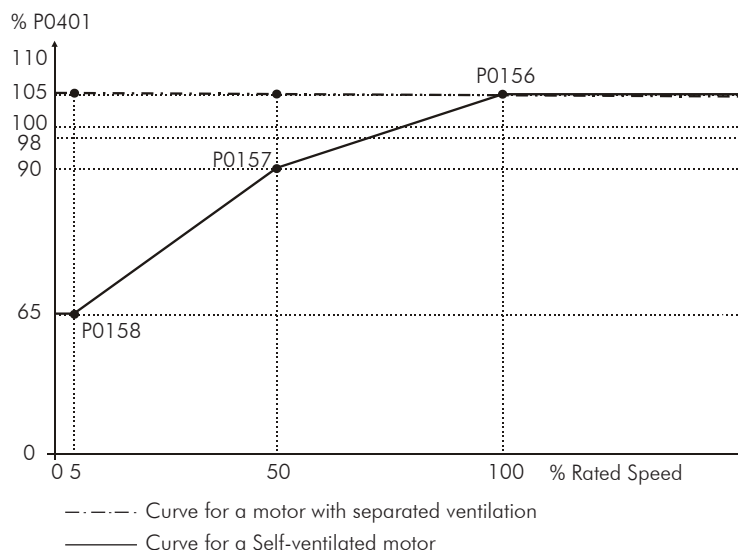

Figure 15.2 - Overload protection levels

With the setting of the overload current curve, it is possible to set an overload value that varies according to the operation speed of the motor (factory setting), improving the protection for self-ventilated motors, or a constant overload level for any speed applied to the motor (motors with separated ventilation).

This curve is adjusted automatically when P0406 (Motor Ventilation Type) is set during the "Oriented Start-up" routine (refer to this parameter description in the [Section 11.7 MOTOR DATA \[43\] on page 11-10](#)).

P0159 – Motor Thermal Class

Adjustable Range:	0 = Class 5 1 = Class 10 2 = Class 15 3 = Class 20 4 = Class 25 5 = Class 30 6 = Class 35 7 = Class 40 8 = Class 45	Factory Setting: 1
Properties:	CFG, V/f, VVW and Vector	
Access groups via HMI:	01 PARAMETER GROUPS 45 Protections	

Description:

This parameter sets the motor thermal class, and the time for the correct actuation of the F072 fault depends on it. The higher the thermal class, the longer the fault actuation time will be.



ATTENTION!
The incorrect selection of the thermal class may cause the burning of the motor.

The necessary data for choosing the thermal class are the following:

- Motor rated current (I_n).
- Blocked rotor current (I_p).
- Blocked rotor time (T_{BR})*.
- Service factor (SF).

* **Note.:** It must be verified if the given blocked rotor time is for hot or cold motor, so that the correspondent thermal class curves be used.

With those values, the overload current and the overload time must be calculated using the following equations:

$$\text{Overload Current} = \frac{I_p}{I_n \times SF} \times 100 (\%)$$

$$\text{Overload Time} = T_{BR} (s)$$

These equations provide the limit conditions for the error actuation, i.e., the motor cannot work with a longer fault actuation time than this one, because of burning risk. Thus, a thermal class immediately inferior must be chosen so that the motor protection is assured.

Example: For a motor with the following characteristics,

$$I_n = 10.8 \text{ A}$$

$$T_{BR} = 4 \text{ s (hot motor blocked rotor time)}$$

$$I_p / I_n = 7.8 \Rightarrow I_p = 7.8 \times 10.8 \text{ A} = 84.2 \text{ A}$$

$$SF = 1.15$$

one gets,

$$\text{Overload Current} = \frac{I_p}{I_n \times SF} = \frac{84.2}{10.8 \times 1.15} \times 100 = 678 \%$$

$$\text{Overload Time} = T_{BR} = 4 \text{ s}$$

After this, it is only necessary to plot the calculated values on the motor overload graph (on page 15-7, and to select the thermal class curve immediately below the calculated point.

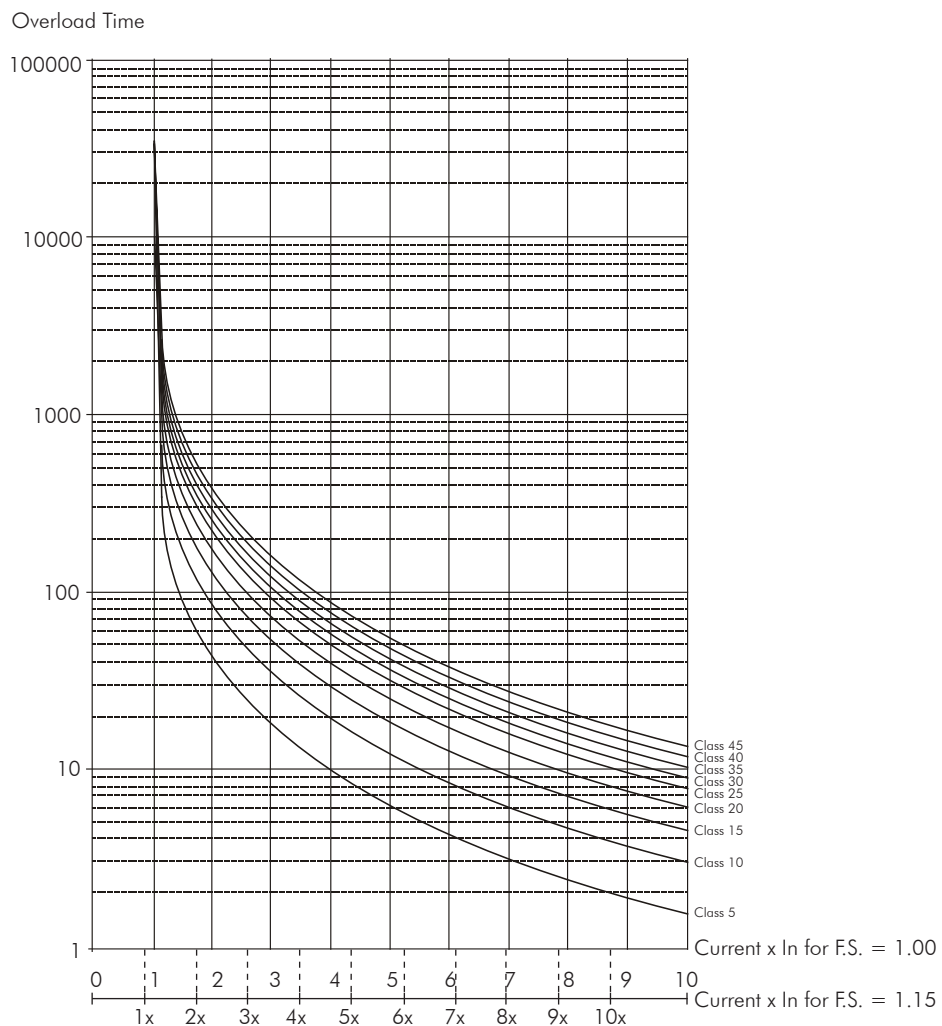

(a) - Cold motor overload curves for loads of the HD and ND types

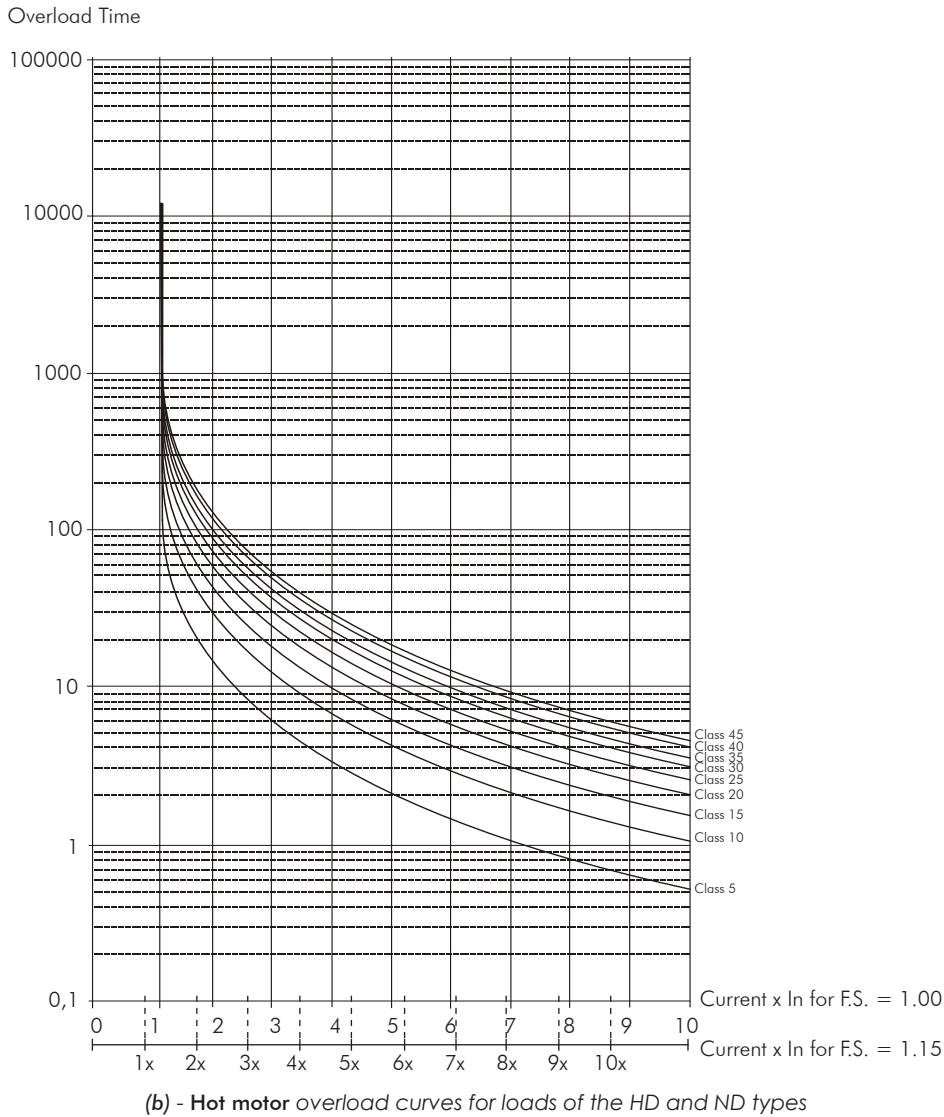

Figure 15.3 - (a) and (b) - Cold and hot motor overload curves for loads of the HD and ND types

For the previous example, by plotting the 678 % value (x axis) of the Overload Current with the 4 seconds (y axis) of the Overload Time in the graph of the Figure 15.2 on page 15-5 (b) (hot motor), the thermal class to be selected will be the class 15 (t15).

P0340 – Auto-Reset Time

Adjustable Range: 0 to 3600 s

Factory Setting: 0 s

Properties:

Access groups via HMI: 01 PARAMETER GROUPS
45 Protections

Description:

When a fault occurs (except F067 – Incorrect Encoder/Motor Wiring and F099 – Invalid Current Offset), the inverter can reset itself automatically after the time set in P0340 has elapsed.



NOTE!

The faults F051, F078, F156, F301, F304, F307, F310, F313, F316, F319, F322, F325, F328, F331, F334, F337, F340 and F343 allow a conditional Reset, i.e., the Reset will only occur if the temperature gets back to the normal operation range.

If after Auto-Reset, the same fault is repeated three times consecutively, the Auto-Reset function will be disabled. A fault is considered consecutive if it happens again within 30 seconds after the Auto-Reset.

Therefore, if a fault occurs four consecutive times, the inverter will remain disabled (general disable) and the fault will remain being indicated.

If $P0340 \leq 2$, auto-reset will not occur.

P0341 – Output Voltage Compensation in V/f

Adjustable Range:	0 = Off 1 = On	Factory Setting:	0
Properties:	CFG and V/f		
Access groups via HMI:	01 PARAMETER GROUPS 23 V/f Control		

Description:

This parameter activates the output voltage compensation for the scalar control for cases in which the inverter has a power supply above the rated value. It ensures that the motor will be powered with the rated voltage value.

E.g.: $P0296 = 380\text{ V}$, $P0400 = 380\text{ V}$ and inverter supply voltage at $380\text{ V} + 15\% = 437\text{ V}$. In this case, with active compensation ($P0341 = 1$) and for the inverter operation at 60 Hz (synchronous speed), the voltage value applied to the motor is 380 V. In case the compensation is not active ($P0341 = 0$), the voltage value applied to the motor is 437 V.



NOTE!

The output voltage compensation (P0341) is always active with the energy saving function enabled.

P0342 – Motor Unbalanced Current Detection

Adjustable Range:	0 = Off 1 = On	Factory Setting:	0
Properties:	CFG		
Access groups via HMI:	01 PARAMETER GROUPS 45 Protections		

Description:

This parameter enables the motor unbalanced current detection, which will be responsible for the F076 fault actuation.

This function will be enabled to actuate when the conditions below were fulfilled simultaneously for longer than 2 seconds.

1. $P0342 = \text{On}$.
2. Enabled inverter.
3. Speed reference higher than 3 %.
4. $|I_u - I_v|$ or $|I_u - I_w|$ or $|I_v - I_w| > 0.125 \times P0401$.

P0343 – Ground Fault Detection

Adjustable Range:	0 = Off 1 = On	Factory Setting: 1
Properties:	CFG	
Access groups via HMI:	01 PARAMETER GROUPS 45 Protections	

Description:

This parameter enables the Ground Fault Detection, which will be responsible for the F074 (Ground Fault) actuation.

Thus if wished, it is possible to inhibit the Ground Fault (F074) occurrence by setting P0343 = Off.

P0348 – Motor Overload Protection

Adjustable Range:	0 = Off 1 = Fault/Alarm 2 = Fault 3 = Alarm	Factory Setting: 1
Properties:	CFG	
Access groups via HMI:	01 PARAMETER GROUPS 45 Protections	

Description:

This parameter allows the desired protection level for the motor overload function to be configured. Refer to the table below for details on the actuation of each one of the available options.

Table 15.2 - Actions for the parameter P0348 options

P0348	Action
0 = Off	The overload protection is disabled. Faults or alarms will not be generated for the motor operation in overload conditions
1 = Fault/Alarm	The inverter will display an alarm (A046) when the motor overload reaches the level programmed in P0349, and will generate a fault (F072) when the motor overload reaches the overload protection tripping level
2 = Fault	Only the fault (F072) will be generated when the motor overload reaches the overload protection trip level, and the inverter will be disabled
3 = Alarm	Only the alarm (A046) is generated when the motor overload reaches the value programmed in P0349 and the inverter continues operating

The trip level of the overload protection is calculated internally by the CFW-11, taking into account the motor current, its thermal class and its service factor. Refer to the parameter P0159 in this section.

P0349 – Motor Overload Alarm Level

Adjustable Range:	70 to 100 %	Factory Setting: 85 %
Properties:	CFG	
Access groups via HMI:	01 PARAMETER GROUPS 45 Protections	

Description:

This parameter defines the level for the motor overload protection alarm actuation (A046), it is expressed as a percentage of the trip level of the overload integrator.

It will only be effective if P0348 is programmed in 1 (Fault/Alarm) or 3 (Alarm).

P0350 – Inverter Overload Protection (IGBTs)

Adjustable Range:	0 = Fault is active, with switching frequency reduction 1 = Fault and alarm are active, with switching frequency reduction 2 = Fault is active, without switching frequency reduction 3 = Fault and alarm are active, without switching frequency reduction	Factory Setting: 1
Properties:	CFG	
Access groups via HMI:	01 PARAMETER GROUPS 45 Protections	

Description:

The inverter overload function operates separately from the motor overload protection, and it has the purpose of protecting the IGBTs and rectifiers in case of overload, avoiding that damage due to overtemperature at their junctions occurs.

Thus, the parameter P0350 allows configuring the desired protection level for this function, even with the automatic reduction of the switching frequency, in order to avoid the fault occurrence. The [Table 15.3 on page 15-11](#) describes each of the available options.

Table 15.3 - Actions for the parameter P0350 options

P0350	Action
0	It enables F048 – IGBT Overload Fault. In order to avoid the occurrence of the fault, the switching frequency is reduced automatically to 2.5 kHz (*)
1	It enables the fault F048 and the alarm A047 – IGBT Overload Alarm. In order to avoid the occurrence of the fault, the switching frequency is reduced automatically to 2.5 kHz (*)
2	It enables F048. Without the reduction of the switching frequency
3	It enables the alarm A047 and the fault F048. Without the reduction of the switching frequency

(*) It reduces the switching frequency when:

- The output current exceeds $1.5 \times I_{nomHD}$ ($1.1 \times I_{nomND}$); **or**.
- The temperature at the IGBT case is less than 10°C from the maximum temperature; **and**.
- P0297 = 2 (5 kHz).

P0351 – Motor Overtemperature Protection

Adjustable Range:	0 = Off 1 = Fault/Alarm 2 = Fault 3 = Alarm	Factory Setting: 1
Properties:	CFG	
Access groups via HMI:	01 PARAMETER GROUPS 45 Protections	

Description:

This parameter is useful when the motor is equipped with PTC type temperature sensors, allowing the configuration of the protection level for the motor overtemperature function. The details on the actuation of the available options are in the [Table 15.4 on page 15-12](#). Refer also to the [Section 15.2 MOTOR OVERTEMPERATURE PROTECTION on page 15-2](#).

Table 15.4 - Actions for the parameter P0351 options

P0351	Action
0 = Off	The overtemperature protection is disabled. Faults or alarms for the motor operation in the overtemperature condition will not be generated
1 = Fault / Alarm	The inverter will show an alarm (A110) and will generate a fault (F078) when the motor reaches the overtemperature actuation values. Once a fault is generated, the inverter will be disabled
2 = Fault	Only the fault (F078) will be generated when the motor reaches the overtemperature protection trip level, and the inverter will be disabled
3 = Alarm	Only the alarm (A110) will be generated when the motor reaches the protection actuation level, and the inverter remains operating

P0352 – Fan Control

Adjustable Range:	0 = Heatsink fan and internal fan are OFF 1 = Heatsink fan and internal fan are ON 2 = Heatsink fan and internal fan are controlled via software 3 = Heatsink fan is controlled via software and internal fan is OFF 4 = Heatsink fan is controlled via software and internal fan is ON 5 = Heatsink fan is ON and internal fan is OFF 6 = Heatsink fan is ON and internal fan is controlled via software 7 = Heatsink fan is OFF and internal fan is ON 8 = Heatsink fan is OFF and internal fan is controlled via software 9 = Fan of the heatsink and internal fan controlled by software (*) 10 = Fan of the heatsink controlled by software, internal fan turned off (*) 11 = Fan of the heatsink controlled by software, internal fan turned on (*) 12 = Fan of the heatsink turned on, internal fan controlled by software (*) 13 = Fan of the heatsink turned off, internal fan controlled by software (*)	Factory Setting: 2
Properties:	CFG	
Access groups via HMI:	<input type="text" value="01 PARAMETER GROUPS"/> <input type="text" value="45 Protections"/>	

Description:

The CFW-11 is equipped with two fans: an internal fan and a heatsink fan, and the activation of both will be controlled via software by means of the inverter programming.

The options available for the setting of this parameter are the following:

Table 15.5 - Options of the parameter P0352

P0352	Action
0 = HS-OFF, Int-OFF	Heatsink fan is always OFF Internal fan is always OFF
1 = HS-ON, Int-ON	Heatsink fan is always ON Internal fan is always ON
2 = HS-CT, Int-CT	Heatsink fan is controlled via software Internal fan is controlled via software
3 = HS-CT, Int-OFF	Heatsink fan is controlled via software Internal fan is always OFF
4 = HS-CT, Int-ON	Heatsink fan is controlled via software Internal fan is always ON
5 = HS-ON, Int-OFF	Heatsink fan is always ON Internal fan is always OFF
6 = HS-ON, Int-CT	Heatsink fan is always ON Internal fan is controlled via software
7 = HS-OFF, Int-ON	Heatsink fan is always OFF Internal fan is always ON
8 = HS-OFF, Int-CT	Heatsink fan is always OFF Internal fan is controlled via software
9 = HS-CT, int-CT *	Heatsink fan is controlled via software Internal fan is controlled via software (*)
10 = HS-CT, int-OFF *	Heatsink fan is controlled via software Internal fan is always OFF (*)
11 = HS-CT, int-ON *	Heatsink fan is controlled via software Internal fan is always ON (*)
12 = HS-ON, int-CT *	Heatsink fan is always ON Internal fan is controlled via software (*)
13 = HS-OFF, int-CT *	Heatsink fan is always OFF Internal fan is controlled via software (*)

(*) The fans will not turn on for one minute after the power-on or after a fault reset.

A delay of fifteen seconds was introduced to turn on (off) the fan after it has been turned off (on).

P0353 – IGBTs and Internal Air Overtemperature Protection

Adjustable Range:	0 = IGBTs: fault and alarm, Internal air: fault and alarm 1 = IGBTs: fault and alarm, Internal air: fault 2 = IGBTs: fault, Internal air: fault and alarm 3 = IGBTs: fault, Internal air: fault 4 = IGBTs: fault and alarm, Internal air: fault and alarm (*) 5 = IGBTs: fault and alarm, Internal air: fault (*) 6 = IGBTs: fault, Internal air: fault and alarm (*) 7 = IGBTs: fault, Internal air: fault (*)	Factory Setting: 0
Properties:	CFG	
Access groups via HMI:	<input type="text" value="01 PARAMETER GROUPS"/> <input type="text" value="45 Protections"/>	

Description:

The overtemperature protection is carried out by means of the measurement of the temperature with the IGBTs and power board internal air NTCs, being able to generate alarms and faults.

In order to configure the desired protection, set P0353 according to the table below.

Table 15.6 - Options of the parameter P0353

P0353	Action
0 = HS-F/A, Air-F/A	Enables fault (F051) – IGBT Overtemperature and alarm (A050) – IGBT High Temperature Enables fault (F153) – Internal Air Overtemperature and alarm (A152) – Internal Air High Temperature Enable Alarm of Overtemperature on the Rectifier (A010)
1 = HS-F/A, Air-F	Enables fault (F051) and alarm (A050) for IGBTs overtemperature Enables only fault (F153) for internal air overtemperature Enable Alarm of Overtemperature on the Rectifier (A010)
2 = HS-F, Air-F/A	Enables only fault (F051) for IGBT overtemperature Enables fault (F153) and alarm (A152) for internal air overtemperature
3 = HS-F, Air-F	Enables only fault (F051) for IGBT overtemperature Enables only fault (F153) for internal air overtemperature
4 = HS-F/A, Air-F/A *	Enables fault (F051) – IGBT Overtemperature and alarm (A050) – IGBT High Temperature Enables fault (F153) – Internal Air Overtemperature and alarm (A152) – Internal Air High Temperature Enable Alarm of Overtemperature on the Rectifier (A010) (*)
5 = HS-F/A, Air-F *	Enables fault (F051) and alarm (A050) for IGBTs overtemperature Enables only fault (F153) for internal air overtemperature Enable Alarm of Overtemperature on the Rectifier (A010) (*)
6 = HS-F, Air-F/A *	Enables only fault (F051) for IGBT overtemperature Enables fault (F153) and alarm (A152) for internal air overtemperature (*)
7 = HS-F, Air-F *	Enables only fault (F051) for IGBT overtemperature Enables only fault (F153) for internal air overtemperature (*)

(*) Disable alarm (A155) and fault (F156).

P0354 – Fan Speed Fault Configuration

Adjustable Range:	0 = Alarm 1 = Fault	Factory Setting: 1
Properties:	CFG	
Access groups via HMI:	01 PARAMETER GROUPS 45 Protections	

Description:

This parameter allows setting whether a fault or an alarm should take place when the heatsink fan reaches $\frac{1}{4}$ of the rated speed. If set to 1, the fault F179 will occur and the inverter will be disabled. If set to 0, the alarm A178 will occur and the inverter won't be disabled.

Table 15.7 - Actions for the parameter P0354 options

P0354	Action
0 = Alarm	The heatsink fan speed fault protection is disabled
1 = Fault	It enables the fault (F179). The inverter will be disabled if the fault occurs

P0355 – Configuration of Fault F185

Adjustable Range:	0 = Off 1 = On	Factory Setting: 1
Properties:	CFG	
Access groups via HMI:	01 PARAMETER GROUPS 45 Protections	

Description:

This parameter allows disabling the actuation of F185 fault – Fault in the preload contactor.

If P0355 = 0, the Fault in the preload contactor will remain deactivated. F185 fault will not be generated. When the inverter is a frame size E with DC power supply it's necessary to adjust P0355 = 0.

P0356 – Dead Time Compensation

Adjustable Range:	0 = Off 1 = On	Factory Setting:	1
Properties:	CFG		
Access groups via HMI:	01 PARAMETER GROUPS 45 Protections		

Description:

This parameter must be kept always in 1 (On). Only in special maintenance cases the value 0 (Off) can be used.

P0357 – Line Phase Loss Time

Adjustable Range:	0 to 60 s	Factory Setting:	3 s
Properties:			
Access groups via HMI:	01 PARAMETER GROUPS 45 Protections		

Description:

It configures the time for the line phase loss indication (F006).

If P0357 = 0, the function remains disabled.



NOTE!

The function Phase Loss will be automatically disabled when detected some of the models: **CFW11 0010 S 2024, CFW11 0006 S 2024FA or CFW11 0007 S 2024 FA.**

If the inverter has single-phase power supply, it is necessary to adjust P0357 = 0 to disable the fault F006.

P0358 – Encoder Fault Configuration

Adjustable Range:	0 = Off 1 = F067 ON 2 = F065, F066 active 3 = All active	Factory Setting: 3
Properties:	CFG and Encoder	
Access groups via HMI:	<div style="border: 1px solid black; padding: 2px; display: inline-block;">01 PARAMETER GROUPS</div> <div style="border: 1px solid black; padding: 2px; display: inline-block; margin-left: 20px;">45 Protections</div>	

Description:

This parameter allows disabling the fault detection by software: a) F067 – Inverted Encoder/Motor Wiring, executed when the Self-Tuning routine is inactive (P0408 = 0) and b) F065, F066 – Encoder Signal Fault (SW). Parameter P0358 is used in the vector control mode with encoder (P0202 = 4).

The verification by software of faults F065, F066 and F067 will remain disabled when P0358 = 0. During the self-tuning (P0408 > 1), fault F067 will be always active, regardless the setting of P0358.



NOTE!

The fault F067 is always disabled when P0202 is programmed 6 (PM motor with encoder), even if P0358 is programmed 1 or 3.

P0359 – Motor Current Stabilization

Adjustable Range:	0 = Off 1 = On	Factory Setting: 0
Properties:	V/f and VVW	
Access groups via HMI:	<div style="border: 1px solid black; padding: 2px; display: inline-block;">01 PARAMETER GROUPS</div> <div style="border: 1px solid black; padding: 2px; display: inline-block; margin-left: 20px;">45 Protections</div>	

Description:

The parameter P0359 allows enabling the motor current stabilizing function.

This function eliminates oscillations in the motor current caused by operation at low speeds with little load.

P0362 – Motor Stop Time Fault

Adjustable Range:	0 to 999 s	Factory Setting:	20 s
Properties:	V/f, VVV, Vector and PM		
Access groups via HMI:	<input type="text" value="01 PARAMETER GROUPS"/> <input type="text" value="20 Ramps"/>	or	<input type="text" value="01 PARAMETER GROUPS"/> <input type="text" value="45 Protections"/>

Description:

This parameter defines the time to generate fault F028 in the motor stop command. The inverter will indicate F028 if the motor stop time exceeds the sum of the value set in the deceleration ramps (P101/P103) and the time set in P0362.

To disable fault F028, set P0362 = 0.

P0800 – Phase U Book 1 Temperature

P0801 – Phase V Book 1 Temperature

P0802 – Phase W Book 1 Temperature

P0803 – Phase U Book 2 Temperature

P0804 – Phase V Book 2 Temperature

P0805 – Phase W Book 2 Temperature

P0806 – Phase U Book 3 Temperature

P0807 – Phase V Book 3 Temperature

P0808 – Phase W Book 3 Temperature

P0809 – Phase U Book 4 Temperature

P0810 – Phase V Book 4 Temperature

P0811 – Phase W Book 4 Temperature

P0812 – Phase U Book 5 Temperature

P0813 – Phase V Book 5 Temperature

P0814 – Phase W Book 5 Temperature

Adjustable Range:	-20.0 °C to 150.0 °C	Factory Setting:	
Properties:	RO		
Access groups via HMI:	01 PARAMETER GROUPS 45 Protections	or	09 READ ONLY PARAMETERS

Description:

These read only parameters indicate, in Celsius degrees (°C), the internal temperature of the IGBTs of each phase of each book. The indication resolution is 0.1 °C. Refer to the CFW-11M user's manual to obtain more information.

P0832 - Digital Input DIM1 Function

P0833 - Digital Input DIM2 Function

Adjustable Range:	0 = Not Used 1 = No External Fault IPS 2 = No Refrigeration Fault 3 = No Braking Overtemperature Fault 4 = No External Rectifier Overtemperature Fault 5 = No External Rectifier Temperature Alarm 6 = No External Rectifier Fault	Factory Setting:	0
Properties:	CFW-11M		
Access groups via HMI:	01 PARAMETER GROUPS 45 Protections	or	01 PARAMETER GROUPS 40 Digital Inputs

Description:

These parameters allow configuring the digital inputs DIM1 and DIM2 for the type of fault (1, 2, 3, 4 or 6) or alarm (5) to be detected. The fault or alarm code will be displayed on the HMI, and the inverter will be disabled when the selected fault occurs.

P0834 - DIM1 and DIM2 Status

Adjustable Range:	Bit 0 = DIM1 Bit 1 = DIM2	Factory Setting:	
Properties:	CFW-11M and RO		
Access groups via HMI:	01 PARAMETER GROUPS 40 Digital Inputs	or	09 READ ONLY PARAMETERS

Description:

Through this parameter it is possible to visualize the status of the 2 digital inputs of the Modular Drive interface board.

The indication is done by means of the numbers 0 and 1, representing respectively the states No Fault/Alarm or With Fault/Alarm at the inputs.

The state of each input is considered as one digit in the sequence where DIM1 represents the least significant digit.

Refer to the CFW-11M user's manual to obtain more information.

15.4 MOTOR OVERTEMPERATURE PROTECTION USING THE IOE-01, IOE-02 OR IOE-03 MODULE

For each type of temperature sensor, PTC, PT100 or KTY84, there is an optional module associated, IOE-01, IOE-02 or IOE-03, respectively.

P0374 - Sensor 1 Temperature Fault/Alarm Configuration

P0377 - Sensor 2 Temperature Fault/Alarm Configuration

P0380 - Sensor 3 Temperature Fault/Alarm Configuration

P0383 - Sensor 4 Temperature Fault/Alarm Configuration

P0386 - Sensor 5 Temperature Fault/Alarm Configuration

Adjustable Range:	0 = Inactive 1 = Temperature Fault/Temperature Alarm/Cable Alarm 2 = Temperature Fault/Cable Alarm 3 = Temperature Alarm/Cable Alarm 4 = Temperature Fault/Temperature Alarm 5 = Temperature Fault 6 = Temperature Alarm 7 = Cable Alarm	Factory Setting: 1
Properties:	CFG	
Access groups via HMI:	01 PARAMETER GROUPS 45 Protections	

Description:

These parameters allow selecting the type of desired action, temperature fault, temperature alarm or broken cable alarm. The rupture of the cable that connects the sensor to the IOE-0x module may cause any of those actions, depending on the selected option.

The [Table 15.8 on page 15-19](#) details the actuation of each available option.

These parameters will be visible on the HMI only when the IOE-01, IOE-02 or IOE-03 optional module is connected into the slot 1 (XC41 connector). Refer to the [Figure 3.1 on page 3-2](#).

Table 15.8 - Available options at parameters P0374/P0377/P0380/P0383/P0386

P0374/P0377/P0380/P0383/P0386	Action
0 = Inactive	The temperature protection is disabled No faults or alarms will be generated
1 = Temperature fault/Temperature alarm/Cable alarm	The inverter will generate the fault (F186/F187/F188/F189/F190) (*), will exhibit the temperature alarm (A191/A192/A193/A194/A195), or the broken cable alarm (A196/A197/A198/A199/A200)
2 = Temperature fault/Cable alarm	The inverter will generate the fault (F186/F187/F188/F189/F190) (*) or will exhibit the broken cable alarm (A196/A197/A198/A199/A200)
3 = Temperature alarm/Cable alarm	The inverter will exhibit the temperature alarm (A191/A192/A193/A194/A195), or the broken cable alarm (A196/A197/A198/A199/A200)
4 = Temperature fault/Temperature alarm	The inverter will generate the fault (F186/F187/F188/F189/F190) (*) or will exhibit the temperature alarm (A191/A192/A193/A194/A195)
5 = Temperature fault	The inverter will generate the fault (F186/F187/F188/F189/F190) (*)
6 = Temperature alarm	The inverter will exhibit the temperature alarm (A191/A192/A193/A194/A195)
7 = Cable alarm	The inverter will exhibit the broken cable alarm (A196/A197/A198/A199/A200)

(*) Once a fault is generated, the inverter will be disabled.

Temperature alarm or broken cable alarm will only affect the HMI. The inverter status (P0006) will not be changed.

15.4.1 PTC Type Temperature Sensor

The next parameters will be shown on the HMI when the IOE-01 module is connected into the slot 1 (XC41 connector). Refer to the [Figure 3.1 on page 3-2](#).

P0373 - PTC 1 Sensor Type

P0376 - PTC 2 Sensor Type

P0379 - PTC 3 Sensor Type

P0382 - PTC 4 Sensor Type

P0385 - PTC 5 Sensor Type

Adjustable Range:	0 = Single PTC 1 = Triple PTC	Factory Setting:	1
Properties:	CFG		
Access groups via HMI:	<input type="text" value="01 PARAMETER GROUPS"/> <input type="text" value="45 Protections"/>		

Description:

These allow selecting the type of used PTC sensor: single or triple.

15.4.2 PT100 or KTY84 Temperature Sensor Type

The parameters described in this section will be shown on the HMI when the IOE-02 or IOE 03 optional module is connected into the slot 1 (XC41 connector). Refer to the [Figure 3.1 on page 3-2](#).

P0375 - Sensor 1 Fault/Alarm Temperature Setting

P0378 - Sensor 2 Fault/Alarm Temperature Setting

P0381 - Sensor 3 Fault/Alarm Temperature Setting

P0384 - Sensor 4 Fault/Alarm Temperature Setting

P0387 - Sensor 5 Fault/Alarm Temperature Setting

Adjustable Range:	-20 to 200 °C	Factory Setting:	130 °C
Properties:	-		
Access groups via HMI:	<input type="text" value="01 PARAMETER GROUPS"/> <input type="text" value="45 Protections"/>		

Description:

These parameters allow adjusting the temperature for each sensor, at which temperature fault/alarm will occur.

P0388 - Sensor 1 Temperature

P0389 - Sensor 2 Temperature

P0390 - Sensor 3 Temperature

P0391 - Sensor 4 Temperature

P0392 - Sensor 5 Temperature

Description:

These parameters indicate, in Celsius degrees, the PT100 or KTY84 sensor temperatures.

P0393 - Highest Sensor Temperature

Adjustable Range:	-20 to 200 °C	Factory Setting:	-
Properties:	RO		
Access groups via HMI:	01 PARAMETER GROUPS	45 Protections	

Description:

This parameter indicates, in Celsius degrees, the highest temperature among the PT100 or KTY84 used sensors.



NOTE!

If any of the temperature fault/alarm configuration parameters, P0374, P0377, P0380, P0383 and/or P0386, is programmed with the "Inactive" option, the respective read-only parameter, P0388, P0389, P0390, P0391 and/or P0392, indicates 0 (zero), not showing the actual sensor temperature. These inactive sensor inputs do not interfere with the P0393 indication. When all the read-only parameters indicate 0 (zero), P0393 will also indicate 0 (zero).

The [Table 15.9 on page 15-22](#) shows the fault or alarm actuation levels and the level that allows their reset.

P0394 – Alarm Temperature Broken Cable

Adjustable Range:	-20 to 200 °C	Factory Setting:	-20 °C
Properties:	-		
Grupos de acesso via HMI:	01 PARAMETER GROUPS		
	45 Protections		

Description:

This parameter detects breaks in the sensor cable (SEN1 to SEN5 of connector XC12) of PT100 (IOE-02) or KTY84 (IOE-03) through the temperature value set in P0394. If the temperature value indicated in parameters P0388 to P0392 is smaller than the value set in P0394, a broken cable alarm occurs in the respective sensor (A196 to A200) after five minutes of the inverter in the Run state.

The default value P0394 = -20 ° corresponds to disabled functionality.

Table 15.9 - Fault and alarm actuation levels

Code	Description	Actuation	Reset
F186	Sensor 1 temperature fault	P0373 = 0: $R_{PTC} > 1.3 \text{ k}\Omega$ P0373 = 1: $R_{PTC} > 4 \text{ k}\Omega$ PT100 and KTY84: P0388 > P0375	P0373 = 0: $R_{PTC} < 550 \Omega$ P0373 = 1: $R_{PTC} < 1.65 \text{ k}\Omega$ PT100 and KTY84: P0388 < (P0375 -15 °C)
F187	Sensor 2 temperature fault	P0376 = 0: $R_{PTC} > 1.3 \text{ k}\Omega$ P0376 = 1: $R_{PTC} > 4 \text{ k}\Omega$ PT100 and KTY84: P0389 > P0378	P0376 = 0: $R_{PTC} < 550 \Omega$ P0376 = 1: $R_{PTC} < 1.65 \text{ k}\Omega$ PT100 and KTY84: P0389 < (P0378 -15 °C)
F188	Sensor 3 temperature fault	P0379 = 0: $R_{PTC} > 1.3 \text{ k}\Omega$ P0379 = 1: $R_{PTC} > 4 \text{ k}\Omega$ PT100 and KTY84: P0390 > P0381	P0379 = 0: $R_{PTC} < 550 \Omega$ P0379 = 1: $R_{PTC} < 1.65 \text{ k}\Omega$ PT100 and KTY84: P0390 < (P0381 -15 °C)
F189	Sensor 4 temperature fault	P0382 = 0: $R_{PTC} > 1.3 \text{ k}\Omega$ P0382 = 1: $R_{PTC} > 4 \text{ k}\Omega$ PT100 and KTY84: P0391 > P0384	P0382 = 0: $R_{PTC} < 550 \Omega$ P0382 = 1: $R_{PTC} < 1.65 \text{ k}\Omega$ PT100 and KTY84: P0391 < (P0384 -15 °C)
F190	Sensor 5 temperature fault	P0385 = 0: $R_{PTC} > 1.3 \text{ k}\Omega$ P0385 = 1: $R_{PTC} > 4 \text{ k}\Omega$ PT100 and KTY84: P0392 > P0387	P0385 = 0: $R_{PTC} < 550 \Omega$ P0385 = 1: $R_{PTC} < 1.65 \text{ k}\Omega$ PT100 and KTY84: P0392 < (P0387 -15 °C)
A191	Sensor 1 temperature alarm	P0373 = 0: $R_{PTC} > 1.3 \text{ k}\Omega$ P0373 = 1: $R_{PTC} > 4 \text{ k}\Omega$ PT100 and KTY84: P0388 > (P0375 -10 °C)	P0373 = 0: $R_{PTC} < 550 \Omega$ P0373 = 1: $R_{PTC} < 1.65 \text{ k}\Omega$ PT100 and KTY84: P0388 < (P0375 -15 °C)
A192	Sensor 2 temperature alarm	P0376 = 0: $R_{PTC} > 1.3 \text{ k}\Omega$ P0376 = 1: $R_{PTC} > 4 \text{ k}\Omega$ PT100 and KTY84: P0389 > (P0378 -10 °C)	P0376 = 0: $R_{PTC} < 550 \Omega$ P0376 = 1: $R_{PTC} < 1.65 \text{ k}\Omega$ PT100 and KTY84: P0389 < (P0378 -15 °C)
A193	Sensor 3 temperature alarm	P0379 = 0: $R_{PTC} > 1.3 \text{ k}\Omega$ P0379 = 1: $R_{PTC} > 4 \text{ k}\Omega$ PT100 and KTY84: P0390 > (P0381 -10 °C)	P0379 = 0: $R_{PTC} < 550 \Omega$ P0379 = 1: $R_{PTC} < 1.65 \text{ k}\Omega$ PT100 and KTY84: P0390 < (P0381 -15 °C)
A194	Sensor 4 temperature alarm	P0382 = 0: $R_{PTC} > 1.3 \text{ k}\Omega$ P0382 = 1: $R_{PTC} > 4 \text{ k}\Omega$ PT100 and KTY84: P0391 > (P0384 -10 °C)	P0382 = 0: $R_{PTC} < 550 \Omega$ P0382 = 1: $R_{PTC} < 1.65 \text{ k}\Omega$ PT100 and KTY84: P0391 < (P0384 -15 °C)
A195	Sensor 5 temperature alarm	P0385 = 0: $R_{PTC} > 1.3 \text{ k}\Omega$ P0385 = 1: $R_{PTC} > 4 \text{ k}\Omega$ PT100 and KTY84: P0392 > (P0387 -10 °C)	P0385 = 0: $R_{PTC} < 550 \Omega$ P0385 = 1: $R_{PTC} < 1.65 \text{ k}\Omega$ PT100 and KTY84: P0392 < (P0387 -15 °C)
A196	Sensor 1 broken cable alarm	P0373 = 0: $R_{PTC} < 20 \Omega$ P0373 = 1: $R_{PTC} < 60 \Omega$ PT100 and KTY84: P0388 < -20 °C	P0373 = 0: $R_{PTC} > 40 \Omega$ P0373 = 1: $R_{PTC} > 120 \Omega$ PT100 and KTY84: P0388 > -20 °C
A197	Sensor 2 broken cable alarm	P0376 = 0: $R_{PTC} < 20 \Omega$ P0376 = 1: $R_{PTC} < 60 \Omega$ PT100 and KTY84: P0389 < -20 °C	P0376 = 0: $R_{PTC} > 40 \Omega$ P0376 = 1: $R_{PTC} > 120 \Omega$ PT100 and KTY84: P0389 > -20 °C
A198	Sensor 3 broken cable alarm	P0379 = 0: $R_{PTC} < 20 \Omega$ P0379 = 1: $R_{PTC} < 60 \Omega$ PT100 and KTY84: P0390 < -20 °C	P0379 = 0: $R_{PTC} > 40 \Omega$ P0379 = 1: $R_{PTC} > 120 \Omega$ PT100 and KTY84: P0390 > -20 °C
A199	Sensor 4 broken cable alarm	P0382 = 0: $R_{PTC} < 20 \Omega$ P0382 = 1: $R_{PTC} < 60 \Omega$ PT100 and KTY84: P0391 < -20 °C	P0382 = 0: $R_{PTC} > 40 \Omega$ P0382 = 1: $R_{PTC} > 120 \Omega$ PT100 and KTY84: P0391 > -20 °C
A200	Sensor 5 broken cable alarm	P0385 = 0: $R_{PTC} < 20 \Omega$ P0385 = 1: $R_{PTC} < 60 \Omega$ PT100 and KTY84: P0392 < -20 °C	P0385 = 0: $R_{PTC} > 40 \Omega$ P0385 = 1: $R_{PTC} > 120 \Omega$ PT100 and KTY84: P0392 > -20 °C

16 READ ONLY PARAMETERS [09]

In order to facilitate the visualization of the main reading variables of the inverter, the group [09] - "Read Only Parameters" can be accessed directly.

It is important to point out that all the parameters of that group can only be visualized on the keypad (HMI) display, and that they do not allow changes by the user.

P0001 – Speed Reference

Adjustable Range:	0 to 18000 rpm	Factory Setting:
Properties:	RO	
Access groups via HMI:	<input type="text" value="09 READ ONLY PARAMETERS"/>	

Description:

This parameter presents, regardless of the origin source adjusted in P0221 or P0222, the value of the speed reference in rpm (factory setting).

The indication unit can be modified from rpm to another unit through P0209, P0210 and P0211, as well as the scale by means of P0208 and P0212.

It is also possible to change the speed reference (P0121) through this parameter, when P0221 or P0222 = 0.

P0002 – Motor Speed

Adjustable Range:	0 to 18000 rpm	Factory Setting:
Properties:	RO	
Access groups via HMI:	<input type="text" value="09 READ ONLY PARAMETERS"/>	

Description:

This parameter indicates the motor actual speed value in rpm (factory setting), with a 0.5 second filter.

The indication unit can be modified from rpm to another unit through P0209, P0210 and P0211, as well as the scale by means of P0208 and P0212.

It is also possible to change the speed reference (P0121) through this parameter, when P0221 or P0222 = 0.

P0003 – Motor Current

Adjustable Range:	0.0 to 4500.0 A	Factory Setting:
Properties:	RO	
Access groups via HMI:	09 READ ONLY PARAMETERS	

Description:

It indicates the inverter output current in Amps (A), by means of 1.0 second filter.

P0004 – DC Link Voltage (U_d)

Adjustable Range:	0 to 2000 V	Factory Setting:
Properties:	RO	
Access groups via HMI:	09 READ ONLY PARAMETERS	

Description:

It indicates the DC Link actual dc voltage in volts (V), by means of 0.1 second filter.

P0005 – Motor Frequency

Adjustable Range:	0.0 to 1020.0 Hz	Factory Setting:
Properties:	RO	
Access groups via HMI:	09 READ ONLY PARAMETERS	

Description:

It indicates the inverter output frequency in Hertz (Hz).

P0006 – Inverter Status

Adjustable Range:	0 = Ready 1 = Run 2 = Undervoltage 3 = Fault 4 = Self-Tuning 5 = Configuration 6 = DC-Braking 7 = STO	Factory Setting:
Properties:	RO	
Access groups via HMI:	09 READ ONLY PARAMETERS	

Description:

It indicates one of the 8 possible inverter states. The description of each state is presented in the next table.

In order to facilitate the visualization, the inverter status is also showed on the top left corner of the keypad (HMI) (Figure 5.3 on page 5-10 – Section 5.6 DISPLAY INDICATIONS IN THE MONITORING MODE SETTINGS on page 5-10). The states 2 to 6 are presented in an abbreviated form, as follows:

Table 16.1 - Description of the inverter status

State	Abbreviated form on the keypad (HMI) top left corner	Description
Ready	Ready	It indicates that the inverter is ready to be enabled
Run	Run	It indicates that the inverter is enabled
Undervoltage	Sub	It indicates that the inverter is with insufficient line voltage for operation (undervoltage), and does not accept enabling commands
Fault	Fxxx, where xxx is the number of the occurred fault	It indicates that the inverter is in the fault state
Self-Tuning	SelfTun	It indicates that the inverter is executing the self-tuning routine
Configuration	Config	It indicates that the inverter is in the Oriented Start-up routine or with incompatible parameter programming. Refer to the Section 5.7 INCOMPATIBILITY BETWEEN PARAMETERS on page 5-12
DC-Braking	DCbreak	It indicates that the inverter is applying DC braking to stop the motor
STO	STO	It indicates that the Safety Stop is active (the 24Vdc voltage from the safety relays coils has been removed)

P0007 – Motor Voltage

Adjustable Range:	0 to 2000 V	Factory Setting:
Properties:	RO	
Access groups via HMI:	09 READ ONLY PARAMETERS	

Description:

It indicates the line voltage estimated in the output of the inverter, in Volts (V), by means of 0.5 second filter.

P0009 – Motor Torque

Adjustable Range:	-1000.0 to 1000.0 %	Factory Setting:
Properties:	RO	
Access groups via HMI:	09 READ ONLY PARAMETERS	

Description:

It indicates the torque developed by the motor, calculated as follows:

Read Only Parameters [09]

$$P0009 = \frac{T_m \times 100}{I_{TM}} \times Y$$

$$1) P0202 \neq 3: I_{TM} = \left(P0401^2 - \left(\frac{P0410 \times P0178}{100} \right)^2 \right)^{0.5}$$

in V/f or VVW the adjusts are: P0178 = 100 % and P0190 = 0.95 x P0400

2) P0202 = 3 or 4:

The motor torque (P0009) in percentage in the operating condition of permanent duty is given by:

$$I_{torque} = \sqrt{P0003^2 - \left(P0410 \times \frac{P0178}{100} \right)^2} \quad (\text{torque current in the operating condition})$$

$$I_{nom_torque} = \sqrt{P0401^2 - \left(P0410 \times \frac{P0178}{100} \right)^2} \quad (\text{Rated torque current})$$

$$P0009 = T_{motor} (\%) = 100 \times \frac{I_{torque}}{I_{nom_torque}} \times k$$

Where the factor k is defined by:

- region of constant flux (constant torque and below or equal to the synchronous speed): $k = 1$.
- region of field weakening (region of constant power; higher than the synchronous speed):

$k = (N_{sync} / P0002) \times (P0190 / P0400)$. Whose N_{sync} is the motor synchronous speed in RPM.

P0010 – Output Power

Adjustable Range: 0.0 to 6553.5 kW

Factory Setting:

Properties: RO

Access groups via HMI: 09 READ ONLY PARAMETERS

Description:

It indicates the electric power in the inverter output. This power is determined through the formula:

$$P0010 = 1.732 \times P0003 \times P0007 \times P0011.$$

Seeing that: $1.732 = \sqrt{3}$.

P0003 is the output current measured.

P0007 is the reference output voltage (or estimated).

P0011 is the value of the cosine [(vector angle of the reference output voltage) – (vector angle of the output current measured)].



NOTE!

The value indicated in this parameter is calculated indirectly, and must not be used to measure the energy consumption.

P0011 – Cos Phi of the Output

Adjustable Range:	0.00 to 1.00	Factory Setting:
Properties:	RO	
Access groups via HMI:	09 READ ONLY PARAMETERS	

Description:

This parameter indicates the value of the cosine of the angle between the voltage and output current. The electric motor are inductive loads and, therefore, consumes reactive power. This power is exchanged between the motor and the inverter and does not produce useful power. According to the operating condition of the motor, the ratio [reactive power / active power] may increase, resulting in a reduction of the output cosine \emptyset .

P0012 – DI8 to DI1 Status

Refer to the [Item 13.1.3 Digital Inputs \[40\]](#) on page 13-12.

P0013 – DO5 to DO1 Status

Refer to the [Item 13.1.4 Digital Outputs / Relays \[41\]](#) on page 13-20.

P0014 – AO1 Value**P0015 – AO2 Value****P0016 – AO3 Value****P0017 – AO4 Value**

Refer to the [Item 13.1.2 Analog Outputs \[39\]](#) on page 13-6.

P0018 – AI1 Value**P0019 – AI2 Value****P0020 – AI3 Value****P0021 – AI4 Value**

Refer to the [Item 13.1.1 Analog Inputs \[38\]](#) on page 13-1.

P0023 – Software Version

Refer to the [Section 6.1 INVERTER DATA \[42\]](#) on page 6-2, for more details.

P0027 – Accessories Configuration 1**P0028 – Accessories Configuration 2****P0029 – Power Hardware Configuration**

Refer to the [Section 6.1 INVERTER DATA \[42\]](#) on page 6-2, for more details.

P0030 – Temperature IGBTs U

P0031 – Temperature IGBTs V

P0032 – Temperature IGBTs W

P0033 – Temperature of the Rectifier

Adjustable Range:	-20.0 to 150.0°C	Factory Setting:	0
Properties:	CFG		
Access groups via HMI:	<div style="border: 1px solid black; padding: 2px; margin-bottom: 2px;">01 PARAMETER GROUPS</div> <div style="border: 1px solid black; padding: 2px; margin-bottom: 2px; margin-left: 20px;">45 Protections</div> <div style="border: 1px solid black; padding: 2px; margin-left: 40px;">09 Read only</div>		

Description:

These parameters present, in Celsius degrees, the temperatures of the heatsink on the U, V and W phases (P0030, P0031 and P0032) of the rectifier (P0033).

They are useful to monitor the temperature on the main inverter sections in case of an occasional overheating.

P0034 – Internal Air Temperature

Refer to the [Section 15.3 PROTECTIONS \[45\]](#) on page 15-4, for more details.

P0035 – Control Air Temperature

Adjustable Range:	-20.0 to 150.0°C	Factory Setting:	
Properties:	RO		
Access groups via HMI:	<div style="border: 1px solid black; padding: 2px; margin-bottom: 2px;">01 PARAMETER GROUPS</div> <div style="border: 1px solid black; padding: 2px; margin-left: 20px;">45 Protections</div> <div style="border: 1px solid black; padding: 2px; margin-left: 40px;">09 Read only</div>		

Description:

Indicates the air temperature near the control board.

P0036 – Heatsink Fan Speed

Adjustable Range:	0 to 15000 rpm	Factory Setting:	
Properties:	RO		
Access groups via HMI:	<div style="border: 1px solid black; padding: 2px;">09 READ ONLY PARAMETERS</div>		

Description:

It indicates the heatsink fan actual speed, in revolutions per minute (rpm).

**NOTE!**

This parameter has no function in mechanics of Modular Drive.

P0037 – Motor Overload Status

Adjustable Range:	0 to 100 %	Factory Setting:
Properties:	RO	
Access groups via HMI:	09 READ ONLY PARAMETERS	

Description:

It indicates the actual overload percentage of the motor. When this parameter reaches 100 % the fault "Motor Overload" (F072) will occur.

P0038 – Encoder Speed

Adjustable Range:	0 to 65535 rpm	Factory Setting:
Properties:	RO	
Access groups via HMI:	09 READ ONLY PARAMETERS	

Description:

It indicates the encoder actual speed, in revolutions per minute (rpm), through a 0.5 second filter.

P0039 – Encoder Pulses Count

Adjustable Range:	0 to 40000	Factory Setting:
Properties:	RO	
Access groups via HMI:	09 READ ONLY PARAMETERS	

Description:

This parameter shows the counting of the pulses of the encoder. The counting can be increased from 0 to 40000 (Hourly turn) or decreased from 40000 to 0 (rotate Counterclockwise). This parameter can be visualized in the analogical exits when P0257 = 49 or P0260 = 49. Consult [Section 12.10 SEARCH OF ZERO OF THE ENCODER](#) on page 12-24.

P0040 – PID Process Variable

P0041 – PID Setpoint Value

Refer to the [Section 20.6 PARAMETERS](#) on page 20-9, for more details.

P0042 – Time Powered

Adjustable Range:	0 to 65535 h	Factory Setting:
Properties:	RO	
Access groups via HMI:	09 READ ONLY PARAMETERS	

Description:

It indicates the total number of hours that the inverter remained powered.

This value is kept even when power is removed from the inverter. The content of P0042 is recorded on the EEPROM when the condition of undervoltage on the DC Link is detected.

P0043 – Time Enabled

Adjustable Range:	0.0 to 6553.5 h	Factory Setting:
Properties:	RO	
Access groups via HMI:	09 READ ONLY PARAMETERS	

Description:

It indicates the total number of hours that the inverter remained enabled.

It indicates up to 6553.5 hours, and then it gets back to zero.

By setting P0204 = 3, the value of the parameter P0043 is reset to zero.

This value is kept even when power is removed from the inverter. The content of P0043 is recorded on the EEPROM when the condition of undervoltage on the DC Link is detected.

P0044 – kWh Counter

Adjustable Range:	0 to 65535 kWh	Factory Setting:
Properties:	RO	
Access groups via HMI:	09 READ ONLY PARAMETERS	

Description:

It indicates the energy consumed by the motor.

It indicates up to 65535 kWh, and then it gets back to zero.

By setting P0204 = 4, the value of the parameter P0044 is reset to zero.

This value is kept even when power is removed from the inverter. The content of P0044 is recorded on the EEPROM when the condition of undervoltage on the DC Link is detected.

**NOTE!**

The value indicated in this parameter is calculated indirectly, and must not be used to measure the energy consumption.

P0045 – Fan Enabled Time

Adjustable Range:	0 to 65535 h	Factory Setting:
Properties:	RO	
Access groups via HMI:	09 READ ONLY PARAMETERS	

Description:

It indicates the total number of hours that the heatsink fan remained enabled.

It indicates up to 65535 hours, and then it gets back to zero.

By setting P0204 = 2, the value of the parameter P0045 is reset to zero.

This value is kept even when power is removed from the inverter. The content of P0045 is recorded on the EEPROM when the condition of undervoltage on the DC Link is detected.

P0048 – Present Alarm**P0049 – Present Fault**

Adjustable Range:	0 to 999	Factory Setting:
Properties:	RO	
Access groups via HMI:	09 READ ONLY PARAMETERS	

Description:

They indicate the alarm (P0048) or fault (P0049) number that occasionally be present at the inverter.

In order to understand the meaning of the codes used for faults and alarms, refer to the [Chapter 15 FAULTS AND ALARMS on page 15-1](#) in this manual and the Chapter 6 - Troubleshooting and Maintenance, of the user's manual.

P0613 – Firmware Revision

Adjustable Range:	-32768 to 32767	Factory Setting:	0
Properties:	RO		
Access groups via HMI:	09 READING PARAMETERS		

Description:

It indicates the number of the inverter firmware version for Weg's internal control.

P0614 – PLD Revision

Adjustable Range:	-32768 to 32767	Factory Setting:	0
Properties:	RO		
Access groups via HMI:	09 READING PARAMETERS		

Description:

It indicates the number of the inverter PLD version for Weg's internal control.

P0692 – Operating Mode States

Adjustable Range:	0 to 65535	Factory Setting:	0
Properties:	RO		
Access groups via HMI:	09 READING PARAMETERS		

Description:

Parameter reserved for WEG.

16.1 FAULT HISTORY [08]

In this group are described the parameters that record the last faults occurred in the inverter, together with other relevant information for the fault interpretation, as date, hour, motor speed, etc.



NOTE!

If the fault occurs simultaneously with the CFW-11 power up or reset, the parameters regarding this fault, as date, hour, motor speed, etc., may contain invalid information.

P0050 – Last Fault**P0054 – Second Fault****P0058 – Third Fault****P0062 – Fourth Fault****P0066 – Fifth Fault****P0070 – Sixth Fault****P0074 – Seventh Fault****P0078 – Eighth Fault****P0082 – Ninth Fault****P0086 – Tenth Fault**

Adjustable Range:	0 to 999	Factory Setting:
Properties:	RO	
Access groups via HMI:	<input type="text" value="08 FAULT HISTORY"/>	

Description:

They indicate the codes from the last to the tenth fault that have occurred.

The recording system is the following:

Fxxx → P0050 → P0054 → P0058 → P0062 → P0066 → P0070 → P0074 → P0078 → P0082 → P0086

P0051 – Last Fault Day/Month**P0055 – Second Fault Day/Month****P0059 – Third Fault Day/Month****P0063 – Fourth Fault Day/Month****P0067 – Fifth Fault Day/Month****P0071 – Sixth Fault Day/Month****P0075 – Seventh Fault Day/Month****P0079 – Eighth Fault Day/Month**

P0083 – Ninth Fault Day/Month

P0087 – Tenth Fault Day/Month

Adjustable Range:	00/00 to 31/12	Factory Setting:
Properties:	RO	
Access groups via HMI:	<input type="text" value="08 FAULT HISTORY"/>	

Description:

They indicate the day and the month of the last to the tenth fault occurrence.

P0052 – Last Fault Year

P0056 – Second Fault Year

P0060 – Third Fault Year

P0064 – Fourth Fault Year

P0068 – Fifth Fault Year

P0072 – Sixth Fault Year

P0076 – Seventh Fault Year

P0080 – Eighth Fault Year

P0084 – Ninth Fault Year

P0088 – Tenth Fault Year

Adjustable Range:	00 to 99	Factory Setting:
Properties:	RO	
Access groups via HMI:	<input type="text" value="08 FAULT HISTORY"/>	

Description:

They indicate the year of the last to the tenth fault occurrence.

P0053 – Last Fault Time**P0057 – Second Fault Time****P0061 – Third Fault Time****P0065 – Fourth Fault Time****P0069 – Fifth Fault Time****P0073 – Sixth Fault Time****P0077 – Seventh Fault Time****P0081 – Eighth Fault Time****P0085 – Ninth Fault Time****P0089 – Tenth Fault Time**

Adjustable Range:	00:00 to 23:59	Factory Setting:
Properties:	RO	
Access groups via HMI:	<input type="text" value="08 FAULT HISTORY"/>	

Description:

They indicate the time of the last to the tenth fault occurrence.

P0090 – Current at the Moment of the Last Fault

Adjustable Range:	0.0 to 4500.0 A	Factory Setting:
Properties:	RO	
Access groups via HMI:	<input type="text" value="08 FAULT HISTORY"/>	

Description:

It is the record of the current supplied by the inverter at the moment of the last fault occurrence.

P0091 – DC Link Voltage at the Moment of the Last Fault

Adjustable Range:	0 to 2000 V	Factory Setting:
Properties:	RO	
Access groups via HMI:	<input type="text" value="08 FAULT HISTORY"/>	

Description:

It is the record of the inverter DC link voltage at the moment of the last fault occurrence.

P0092 – Speed at the Moment of the Last Fault

Adjustable Range:	0 to 18000 rpm	Factory Setting:
Properties:	RO	
Access groups via HMI:	<input type="text" value="08 FAULT HISTORY"/>	

Description:

It is the record of the motor speed at the moment of the last fault occurrence.

P0093 – Reference at the Moment of the Last Fault

Adjustable Range:	0 to 18000 rpm	Factory Setting:
Properties:	RO	
Access groups via HMI:	<input type="text" value="08 FAULT HISTORY"/>	

Description:

It is the record of the speed reference at the moment of the last fault occurrence.

P0094 – Frequency at the Moment of the Last Fault

Adjustable Range:	0.0 to 1020.0 Hz	Factory Setting:
Properties:	RO	
Access groups via HMI:	<input type="text" value="08 FAULT HISTORY"/>	

Description:

It is the record of the inverter output frequency at the moment of the last fault occurrence.

P0095 – Motor Voltage at the Moment of the Last Fault

Adjustable Range:	0 to 2000 V	Factory Setting:
Properties:	RO	
Access groups via HMI:	08 FAULT HISTORY	

Description:

It is the record of the motor voltage at the moment of the last fault occurrence.

P0096 – DIx Status at the Moment of the Last Fault

Adjustable Range:	Bit 0 = DI1 Bit 1 = DI2 Bit 2 = DI3 Bit 3 = DI4 Bit 4 = DI5 Bit 5 = DI6 Bit 6 = DI7 Bit 7 = DI8	Factory Setting:
Properties:	RO	
Access groups via HMI:	08 FAULT HISTORY	

Description:

It indicates the state of the digital inputs at the moment of the last fault occurrence.

The indication is done by means of an hexadecimal code, which when converted to binary will indicate the states "active" and "inactive" of the inputs through numbers 1 and 0.

Example: If the code presented for the parameter P0096 on the keypad (HMI) is 00A5, it will correspond to the sequence **10100101**, indicating that the inputs 8, 6, 3 and 1 were active at the moment of the last fault occurrence.

Table 16.2 - Example of correspondence between the P0096 hexadecimal code and the DIx states

0				0				A				5			
0	0	0	0	0	0	0	0	1	0	1	0	0	1	0	1
No relation with the DIx (always zero)								DI8 Active (+24 V)	DI7 Inactive (0 V)	DI6 Active (+24 V)	DI5 Inactive (0 V)	DI4 Inactive (0 V)	DI3 Active (+24 V)	DI2 Inactive (0 V)	DI1 Active (+24 V)

P0097 – DOx Status at the Moment of the Last Fault

Adjustable Range:	Bit 0 = DO1 Bit 1 = DO2 Bit 2 = DO3 Bit 3 = DO4 Bit 4 = DO5	Factory Setting:
Properties:	RO	
Access groups via HMI:	08 FAULT HISTORY	

Description:

It indicates the state of the digital outputs at the moment of the last fault occurrence.

The indication is done by means of an hexadecimal code, which when converted to binary will indicate the states "active" and "inactive" of the outputs through numbers 1 and 0.

Example: If the code presented for the parameter P0097 on the keypad (HMI) is 001C, it will correspond to the sequence **00011100**, indicating that the outputs 5, 4, and 3 were active at the moment of the last fault occurrence.

Table 16.3 - Example of correspondence between the P0097 hexadecimal code and the DOx states

0				0				1			C					
0	0	0	0	0	0	0	0	0	0	0	1	1	1	0	0	
No relation with the DOx (always zero)				No relation with the DOx (always zero)				DO5 Active (+24 V)	DO4 Active (+24 V)	DO3 Active (+24 V)	DO2 Inactive (0 V)	DO1 Inactive (0 V)				

P0800 – Phase U Book 1 Temperature

P0801 – Phase V Book 1 Temperature

P0802 – Phase W Book 1 Temperature

P0803 – Phase U Book 2 Temperature

P0804 – Phase V Book 2 Temperature

P0805 – Phase W Book 2 Temperature

P0806 – Phase U Book 3 Temperature

P0807 – Phase V Book 3 Temperature

P0808 – Phase W Book 3 Temperature

P0809 – Phase U Book 4 Temperature

P0810 – Phase V Book 4 Temperature

P0811 – Phase W Book 4 Temperature

P0812 – Phase U Book 5 Temperature

P0813 – Phase V Book 5 Temperature

P0814 – Phase W Book 5 Temperature

Adjustable Range:	-20.0 to 150.0°C	Factory Setting:
Properties:	CFG	
Access groups via HMI:	<div style="border: 1px solid black; padding: 2px; margin-bottom: 2px;">01 PARAMETER GROUPS</div> <div style="border: 1px solid black; padding: 2px; margin-bottom: 2px; margin-left: 20px;">45 Protections</div> <div style="border: 1px solid black; padding: 2px; margin-left: 40px;">09 Read only</div>	

Description:

These reading parameters indicate, in Celsius degrees (°C), the internal temperature of the IGBTs of each phase. In a modular drive, this information is shown for each Book, and for frame H it is shown for each IGBT module. The indication resolution is 0.1°C (32.18 °F).

P0834 – DIM1 and DIM2 Status

For more information, refer to [Section 15.3 PROTECTIONS \[45\] on page 15-4](#).

17 COMMUNICATION [49]

For the exchange of information through communication networks, the CFW-11 has several standardized communication protocols, like MODBUS, CANopen, DeviceNet, and Ethernet/IP.

For more details regarding the inverter configuration for operating with those protocols, refer to the CFW-11 communication manuals. The parameters regarding the communication are explained next.

17.1 RS-232 AND RS-485 SERIAL INTERFACE

P0308 – Serial Address

P0310 – Serial Baud Rate

P0311 – Serial Interface Byte Configuration

P0312 – Serial Protocol

P0314 – Serial Watchdog

P0316 – Serial Interface Status

P0682 – Serial / USB Control Word

P0683 – Serial / USB Speed Reference

Those are parameters for the configuration and operation of the RS-232 and RS-485 serial interfaces. For a detailed description, refer to the RS-232/RS-485 communication manual, available in www.weg.net.

17.2 CAN INTERFACE – CANOPEN/DEVICENET

P0684 – CANopen/DeviceNet Control Word

P0685 – CANopen/DeviceNet Speed Reference

P0700 – CAN Protocol

P0701 – CAN Address

P0702 – CAN Baud Rate

P0703 – Bus Off Reset

P0705 – CAN Controller Status

P0706 – Received CAN Telegram Counter

P0707 – Transmitted CAN Telegram Counter

P0708 – Buss Off Error Counter

P0709 – Lost CAN Message Counter

P0710 – DeviceNet I/O Instances

P0711 – DeviceNet Reading Word #3

P0712 – DeviceNet Reading Word #4

P0713 – DeviceNet Reading Word #5

P0714 – DeviceNet Reading Word #6

P0715 – DeviceNet Writing Word #3

P0716 – DeviceNet Writing Word #4

P0717 – DeviceNet Writing Word #5

P0718 – DeviceNet Writing Word #6

P0719 – DeviceNet Network Status

P0720 – DeviceNet Master Status

P0721 – CANopen Communication Status

P0722 – CANopen Node Status

Those are parameters for the configuration and operation of the CAN interface. For a detailed description, refer to the CANopen communication manual or to the DeviceNet communication manual, available in www.weg.net.

17.3 ANYBUS-CC INTERFACE

P0686 – Anybus-CC Control Word

P0687 – Anybus-CC Speed Reference

P0723 – Anybus Identification

P0724 – Anybus Communication Status

P0725 – Anybus Address

P0726 – Anybus Baud Rate

P0727 – Anybus I/O Words

P0728 – Anybus Reading Word #3

P0729 – Anybus Reading Word #4

P0730 – Anybus Reading Word #5

P0731 – Anybus Reading Word #6

P0732 – Anybus Reading Word #7

P0733 – Anybus Reading Word #8

P0734 – Anybus Writing Word #3

P0735 – Anybus Writing Word #4

P0736 – Anybus Writing Word #5

P0737 – Anybus Writing Word #6

P0738 – Anybus Writing Word #7

P0739 – Anybus Writing Word #8

P0741 – Profibus Data Profile

P0760 – PROFIdrive Output Current

P0761 – PROFIdrive Output Power

P0762 – PROFIdrive Output Torque

P0763 – PROFIdrive namur Status Word

P0840 – Anybus Status

P0841 – Ethernet Baud Rate

P0842 – TCP Modbus Timeout

P0843 – IP Address Configuration

P0844 – IP1 Address

P0845 – IP2 Address

P0846 – IP3 Address

P0847 – IP4 Address

P0848 – CIDR

P0849 – Gateway 1

P0850 – Gateway 2

P0851 – Gateway 3

P0852 – Gateway 4

P0853 – Suffix for Station Name

P0854 – Compatibility Mode

P0967 – PROFIdrive Control Word

P0968 – PROFIdrive Status Word

Those are parameters for the configuration and operation of the Anybus-CC interface. For a detailed description, refer to the Anybus-CC communication manual, available in www.weg.net.

17.4 PROFIBUS DP INTERFACE

P0684 – Control Word via CANopen/DeviceNet/Profibus DP

P0685 – Speed Reference via CANopen/DeviceNet/Profibus DP

P0740 - Profibus Comm. Status

P0741 – Profibus Data Profile

P0742 – Profibus Reading Word #3

P0743 – Profibus Reading Word #4

P0744 – Profibus Reading Word #5

P0745 – Profibus Reading Word #6

P0746 – Profibus Reading Word #7

P0747 – Profibus Reading Word #8

P0748 – Profibus Reading Word #9

P0749 – Profibus Reading Word #10

P0750 – Profibus Writing Word #3

P0751 – Profibus Writing Word #4

P0752 – Profibus Writing Word #5

P0753 – Profibus Writing Word #6

P0754 – Profibus Writing Word #7

P0755 – Profibus Writing Word #8

P0756 – Profibus Writing Word #9

P0757 – Profibus Writing Word #10

P0760 – PROFIdrive Output Current

P0761 – PROFIdrive Output Power

P0762 – PROFIdrive Output Torque

P0763 – PROFIdrive Namur Status Word

P0918 – Profibus Address

P0922 – Profibus Telegram Selection

P0944 – Fault Counter

P0947 – Fault Number

P0963 – Profibus Baud Rate

P0964 – Drive Identification

P0965 – Profile Identification

P0967 – Control Word 1

P0968 – Status Word 1

Those are parameters for the configuration and operation of the Profibus DP interface. For a detailed description, refer to the Profibus DP communication manual, available in www.weg.net.

17.5 COMMUNICATION STATES AND COMMANDS

P0313 – Communication Error Action

P0680 – Logical Status

P0681 – Motor Speed in 13 bits

P0692 – Operation Mode Status

P0693 – Operation Mode Commands

P0695 – Digital Output Setting

P0696 – Analog Outputs Value 1

P0697 – Analog Outputs Value 2

P0698 – Analog Outputs Value 3

P0699 – Analog Outputs Value 4

P0799 – I/O Update Delay

Those parameters are used for monitoring and controlling the CFW-11 inverter by means of communication interfaces. For a detailed description, refer to the communication manual of the used interface. These manuals are available in www.weg.net.

18 SOFTPLC [50]

18.1 SOFTPLC

The SoftPLC function allows the frequency inverter to assume PLC (Programmable Logical Controller) functions. For more details regarding the programming of those functions in the CFW-11, refer to the CFW-11 SoftPLC manual. The parameters related to the SoftPLC are described next.

P1000 – SoftPLC Status

P1001 – SoftPLC Command

P1002 – Scan Cycle Time

P1004 – SoftPLC Supervision

P1010 to P1059 – SoftPLC Parameters





NOTE!

Parameters P1010 to P1019 can be visualized in the Monitoring Mode (Refer to the [Section 5.4 HMI \[30\]](#) on page 5-4, and [Section 5.6 DISPLAY INDICATIONS IN THE MONITORING MODE SETTINGS](#) on page 5-10).



NOTE!

When P1011 is a writing parameter and is programmed in P0205, P0206 or P0207, then its contents can be changed in the Monitoring Menu (Refer to the [Section 5.6 DISPLAY INDICATIONS IN THE MONITORING MODE SETTINGS](#) on page 5-10) by using the HMI  or  key.

18.2 I/O CONFIGURATION [07]

The next digital inputs and outputs are for the SoftPLC exclusive use.

18.2.1 Digital Inputs [40]

The next parameters will be visualized on the HMI when the IOC-01, IOC-02 or IOC-03 module is connected into the slot 1 (XC41 connector).

P0025 – DI9 to DI16 Status

Adjustable Range:	Bit 0 = DI9 Bit 1 = DI10 Bit 2 = DI11 Bit 3 = DI12 Bit 4 = DI13 Bit 5 = DI14 Bit 6 = DI15 Bit 7 = DI16	Factory Setting: -
Properties:	RO	
Access groups via HMI:	01 PARAMETER GROUPS 40 Digital Inputs	or 07 I/O CONFIGURATION 40 Digital Inputs

Description:

By means of this parameter, it is possible to visualize the status of the 8 digital inputs (DI9 to DI16) of the IOC-01, IOC-02 or IOC-03 module. The indication is done by means of the numbers 1 and 0, representing respectively the "Active" and "Inactive" states of the inputs. The state of each input is considered as one digit in the sequence where DI9 represents the least significant digit.

18.2.2 Digital Outputs [41]

At the IOC-01, 4 relay contact digital outputs (NO relay contact) are available, DO6 to DO9. At the IOC-02, 8 open collector type digital outputs are available, DO6 to DO13. The module IOC-03 provides 7 digital outputs type PNP, galvanically isolated of 500 mA each.

P0026 – DO6 to DO13 Status

Adjustable Range:	Bit 0 = DO6 Bit 1 = DO7 Bit 2 = DO8 Bit 3 = DO9 Bit 4 = DO10 Bit 5 = DO11 Bit 6 = DO12 Bit 7 = DO13	Factory Setting: -
Properties:	RO	
Access groups via HMI:	01 PARAMETER GROUPS 41 Digital Outputs	or 07 I/O CONFIGURATION 41 Digital Outputs

Description:

By means of this parameter, it is possible to visualize the status of the IOC-01 module 4 digital outputs, the status of the 8 digital outputs of module IOC-02 or the status of the 7 digital outputs of the module IOC-03. The indication is done by means of the numbers "1" and "0", representing respectively the "Active" and "Inactive" states of the outputs. The state of each output is considered as one digit in the sequence where DO6 represents the least significant digit.

Note: When the IOC-01 module is used, the indications of bits DO10 to DO13 stay inactive. When the IOC-03 module is used, the indication of bit DO13 stay inactive.

19 TRACE FUNCTION [52]

19.1 TRACE FUNCTION

The trace function is used to record variables of interest from the CFW-11 (as current, voltage, speed) when a particular event occurs in the system (e.g.: alarm/fault, high current, etc.). This system event, for starting the data recording process, is called "trigger". The stored variables can be visualized as graphs through the SuperDrive G2 executed by a PC connected via USB or Serial to the CFW-11.

The parameters related to this function are presented next.

P0550 – Trigger Signal Source

Adjustable Range:	0 = Not selected 1 = Speed Reference 2 = Motor Speed 3 = Motor Current 4 = DC Link Voltage 5 = Motor Frequency 6 = Motor Voltage 7 = Motor Torque 8 = Process Variable 9 = PID Setpoint 10 = AI1 11 = AI2 12 = AI3 13 = AI4	Factory Setting: 0
Properties:		
Access groups via HMI:	01 PARAMETER GROUPS 52 Trace Function	

Description:

It selects the variable that will be used as the trigger source for the Trace Function.

This parameter has no effect when P0552 = "Alarm", "Fault" or "Dlx".

Those same variables can also be used as signals to be acquired, through the parameters from P0561 up to P0564.

P0551 – Trigger Level for Trace

Adjustable Range:	-100.0 to 340.0 %	Factory Setting: 0.0 %
Properties:		
Access groups via HMI:	01 PARAMETER GROUPS 52 Trace Function	

Description:

It defines the value for comparison with the variable selected in P0550.

The full range of the variables selectable as trigger is presented in the next table.

Table 19.1 - Full scale of the variables selectable as trigger

Variable	Full Scale
Speed Reference	100 % = P0134
Motor Speed	100 % = P0134
Motor Current	200 % = 2.0 x I _{nomHD}
DC Link Voltage	100 % = Max. Lim. P0151
Motor Frequency	340 % = 3.4 x P0403
Motor Voltage	100 % = 1.0 x P0400
Motor Torque	200 % = 2.0 x I _{nom Motor}
Process Variable	100 % = 1.0 x P0528
PID Setpoint	100 % = 1.0 x P0528
AI1	100 % = 10 V/20 mA
AI2	100 % = 10 V/20 mA
AI3	100 % = 10 V/20 mA
AI4	100 % = 10 V/20 mA

This parameter has no effect when P0552 = "Alarm", "Fault" or "Dlx".

P0552 – Trigger Condition for Trace

Adjustable Range:	0: P0550* = P0551 1: P0550* <> P0551 2: P0550* > P0551 3: P0550* < P0551 4: Alarm 5: Fault 6: Dlx	Factory Setting: 5
Properties:		
Access groups via HMI:	01 PARAMETER GROUPS 52 Trace Function	

Description:

It defines the condition for starting the signal acquisition. The [Table 19.2 on page 19-2](#) details the available options.

Table 19.2 - Parameter P0552 option description

P0552 Options	Description
P0550* = P0551	The variable selected in P0550 is equal to the value adjusted in P0551
P0550* ≠ P0551	The variable selected in P0550 is different from the value adjusted in P0551
P0550* > P0551	The variable selected in P0550 is bigger than the value adjusted in P0551
P0550* < P0551	The variable selected in P0550 is smaller than the value adjusted in P0551
Alarm	Inverter with an active alarm
Fault	Inverter in fault state
Dlx	Digital input (selected via P0263 – P0270)

For P0552=6 ("Dlx" option), it is necessary to select the option "Trace Function" at one of the parameters from P0263 to P0270. For more details, refer to the [Item 13.1.3 Digital Inputs \[40\] on page 13-12](#).

Notes:

- If P0552 = 6 and no DI is configured for "Trace Function", the trigger will not occur.
- If P0552 = 6 and several DIs were configured for "Trace Function", only one has to be active for the trigger occurrence.

- If P0552 ≠ 6 and any DI is configured for "Trace Function", the trigger will never occur as a result of the DI activation.
- These three programming options do not prevent the inverter from being enabled.

P0553 – Trace Sampling Period

Adjustable Range:	1 to 65535	Factory Setting:	1
Properties:			
Access groups via HMI:	<div style="border: 1px solid black; padding: 2px; display: inline-block;">01 PARAMETER GROUPS</div> <div style="border: 1px solid black; padding: 2px; display: inline-block; margin-left: 20px;">52 Trace Function</div>		

Description:

It defines the sampling period (time between two sampling points) as a 200 μ s multiple.

For P0297 = 1.25 kHz, it defines the sampling period as a 400 μ s multiple

P0554 – Trace Pre-Trigger

Adjustable Range:	0 to 100 %	Factory Setting:	0 %
Properties:			
Access groups via HMI:	<div style="border: 1px solid black; padding: 2px; display: inline-block;">01 PARAMETER GROUPS</div> <div style="border: 1px solid black; padding: 2px; display: inline-block; margin-left: 20px;">52 Trace Function</div>		

Description:

It is the data percentage that will be recorded before the occurrence of the trigger event.

P0559 – Trace Maximum Memory

Adjustable Range:	0 to 100 %	Factory Setting:	0 %
Properties:			
Access groups via HMI:	<div style="border: 1px solid black; padding: 2px; display: inline-block;">01 PARAMETER GROUPS</div> <div style="border: 1px solid black; padding: 2px; display: inline-block; margin-left: 20px;">52 Trace Function</div>		

Description:

It defines the maximum of memory that the user wished to reserve for the Trace Function points. The setting range, from 0 to 100 %, corresponds to a reserve request of 0 to 15 KB for the Trace Function.

Each point stored by the Trace Function takes 2 bytes of memory. This parameter defines indirectly the number of points that the user wishes to store with the Trace Function.

The memory area used by the Trace Function is shared with the memory for the SoftPLC applicative. When there is a SoftPLC applicative in the inverter, the amount of memory actually available for the Trace Function may be smaller than the value adjusted in P0559. The indication of the memory amount actually available is done by the read only parameter P0560. For more details refer to the parameter P0560 description.

As the factory setting, P0559 = 0 %. In this case, there is no memory available for the Trace Function, because the available 15 KB are reserved for the SoftPLC applicative.

P0560 – Trace Available Memory

Adjustable Range:	0 to 100 %	Factory Setting:
Properties:	RO	
Access groups via HMI:	<div style="border: 1px solid black; padding: 2px; display: inline-block;">01 PARAMETER GROUPS</div> <div style="border: 1px solid black; padding: 2px; display: inline-block; margin-left: 20px;">52 Trace Function</div>	

Description:

It shows the amount of memory available for storing Trace Function points. The range from 0 to 100 % indicates that from 0 to 15 KB are available for the Trace Function.

Sharing of memory with the SoftPLC:

The memory for the Trace Function is shared with the memory for the SoftPLC applicative.

- If P1000=0 (there is no SoftPLC applicative), it is possible to use all the memory area for the Trace Function. In this case, P0559 = P0560.
- If P1000>0 (there is SoftPLC applicative in the inverter), P0560 will show the smallest value between P0559 and the actual available memory (that will be 100 % minus the memory used by the SoftPLC applicative).

In order to be able to use the Trace Function, the user must adjust P0559 with a value greater than 0 %, and equal or less than the P0560 indication. If P0559 > P0560 and the user wishes to use more memory for the Trace Function, then the SoftPLC applicative must be erased by means of the parameter P1001.

NOTE!
If P0559 > P0560, then distortion in the observed signals may occur.

Function, then the SoftPLC applicative must be erased by means of the parameter P1001.

P0561 – CH1: Trace channel 1

P0562 – CH2: Trace channel 2

P0563 – CH3: Trace channel 3

P0564 – CH4: Trace channel 4

Adjustable Range:	0 = Not selected 1 = Speed Reference 2 = Motor Speed 3 = Motor Current 4 = DC Link Voltage 5 = Motor Frequency 6 = Motor Voltage 7 = Motor Torque 8 = Process Variable 9 = PID Setpoint 10 = AI1 11 = AI2 12 = AI3 13 = AI4	Factory Setting:	P0561 = 1 P0562 = 2 P0563 = 3 P0564 = 0
Properties:			
Access groups via HMI:	<div style="border: 1px solid black; padding: 2px; display: inline-block;">01 PARAMETER GROUPS</div> <div style="border: 1px solid black; padding: 2px; display: inline-block; margin-left: 20px;">52 Trace Function</div>		

Description:

They select the signals that will be recorded at the channels 1 to 4 of the Trace Function.

The options are the same that are available at P0550. By selecting the "Not Selected" option, the total memory available for the Trace function is distributed between the active channels.

P0571 – Start Trace Function

Adjustable Range:	0 = Off 1 = On	Factory Setting:	0
Properties:			
Access groups via HMI:	<div style="border: 1px solid black; padding: 2px;">01 PARAMETER GROUPS</div> <div style="border: 1px solid black; padding: 2px; margin-left: 20px;">52 Trace Function</div>		

Description:

It initiates the waiting for the Trace Function trigger.

Since it is a parameter that can be changed with the motor running, it is not necessary to press "Save" on the keypad (HMI) for the "trigger" waiting to initiate.

This parameter does not have effect if there is no active channel or if there is no memory available for the Trace Function (P0560 = 0).

P0571 returns automatically to 0, for safety reasons, if any of the parameters between P0550 and P0564 is changed.

P0572 – Day/Month Trace Triggered

Adjustable Range:	00/00 to 31/12	Factory Setting:	
--------------------------	----------------	-------------------------	--

P0573 – Year Trace Triggered

Adjustable Range:	00 to 99	Factory Setting:	
--------------------------	----------	-------------------------	--

P0574 – Hour Trace Triggered

Adjustable Range:	00:00 to 23:59	Factory Setting:	
--------------------------	----------------	-------------------------	--

P0575 – Second Trace Triggered

Adjustable Range:	00 to 59	Factory Setting:	
Properties:			
Access groups via HMI:	<div style="border: 1px solid black; padding: 2px;">RO</div> <div style="border: 1px solid black; padding: 2px; margin-left: 20px;">01 PARAMETER GROUPS</div> <div style="border: 1px solid black; padding: 2px; margin-left: 20px;">52 Trace Function</div>		

Description:

P0572 to P0575 record the date and hour of the trigger occurrence. These parameters and the points acquired by the Trace Function are not saved when the inverter is powered off.

- ☑ There are two possibilities for P0572 to P0575 being null:
 - No acquisition was performed after the inverter power on, **or**.
 - Trace happened without keypad (HMI) connected to the inverter (no RTC).

P0576 – Trace Function Status

Adjustable Range:	0 = Off 1 = Waiting 2 = Triggered 3 = Concluded	Factory Setting:
Properties:	RO	
Access groups via HMI:	01 PARAMETER GROUPS └─ 52 Trace Function	

Description:

It indicates if the Trace function has been initiated, if there has been already a trigger and if the signals have already been completely acquired.

20 PID REGULATOR [46]

20.1 DESCRIPTION AND DEFINITIONS

The CFW-11 has the special function PID REGULATOR, which can be used to control a closed loop process. This function places a proportional, integral and derivative regulator, superposed to the normal CFW-11 speed control. Refer to the block diagram in the [Figure 20.1 on page 20-2](#).

The process control is done by means of the motor speed variation, keeping the value of the process variable (the one to be controlled) at the desired value.

Application examples: the control of flow or pressure in a piping, of the temperature in a furnace or in a greenhouse, or of the chemicals dosage in tanks.

In order to define the terms used by a PID control, we are going to use a simple example.

An electro-pump is used in a water pumping system where the pressure in the pump output pipe has to be controlled. A pressure transducer is installed in the pipe and supplies an analog **feedback** signal to the CFW-11, which is proportional to the water pressure. This signal is called the **process variable**, and can be visualized at the parameter P0040. A **setpoint** is programmed in the CFW-11 via the keypad (HMI) (P0525) or adjusted through an analog input (as a 0 to 10 V or 4 to 20 mA signal). The setpoint is the desired water pressure value that the pump is supposed to produce, regardless of the consumption variations at the pump output at any time.

The CFW-11 will compare the setpoint with the process variable and control the motor speed trying to eliminate any error and keeping the process variable equal to the setpoint. The setting of the P, I and D gains determines how fast the inverter will respond to eliminate this error.

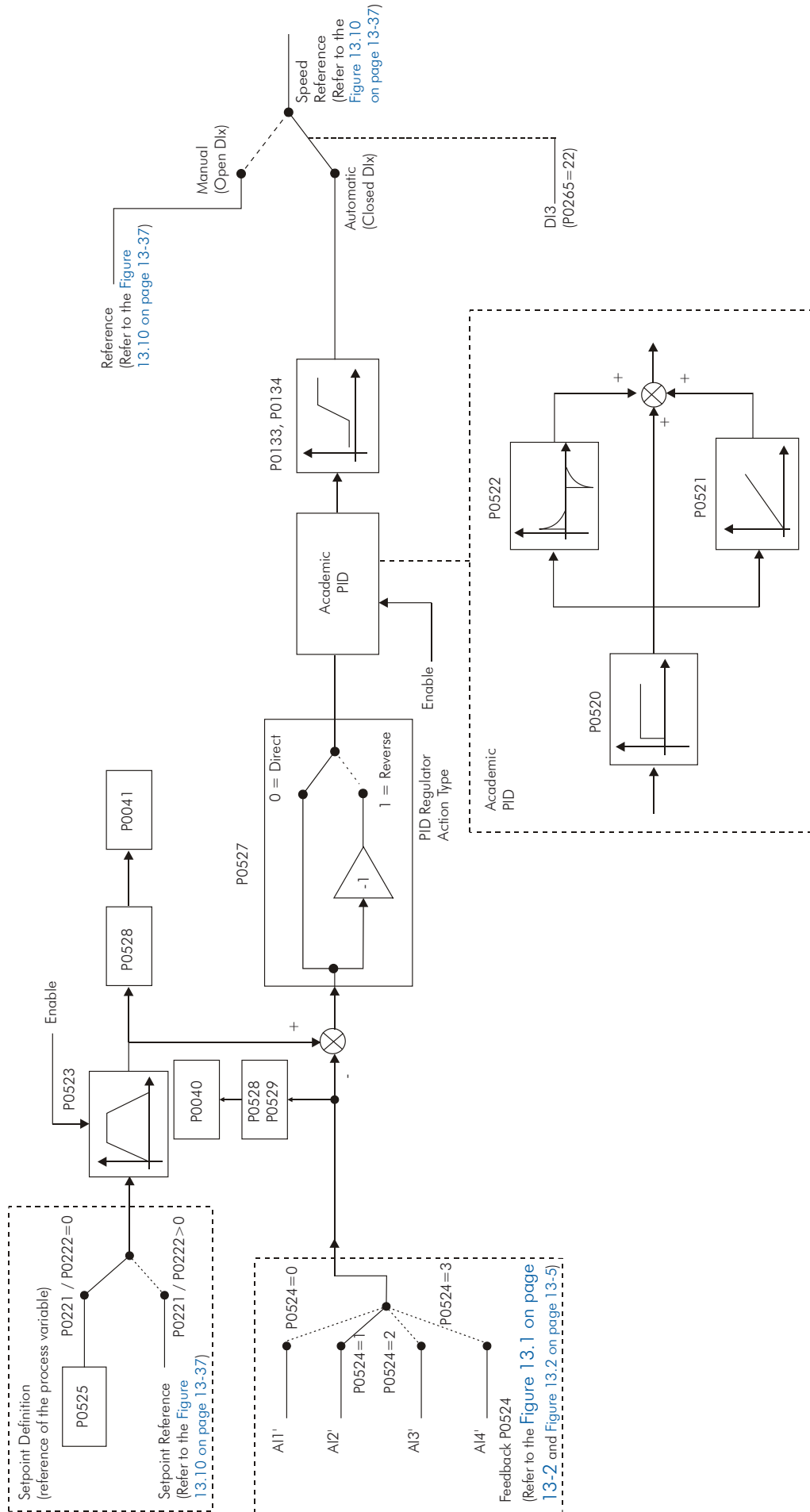

Figure 20.1 - PID Regulator function block diagram

20.2 COMMISSIONING

Before doing a detailed description of the parameters related to this function, a step by step guide for putting the PID into operation will be presented.



NOTE!

In order that the PID function works properly, it is fundamental to verify if the inverter is configured correctly to drive the motor at the desired speed. Therefore, verify the following settings:

- Torque boost (P0136 and P0137) and slip compensation (P0138), if it were in the V/f control mode.
- Having run the self-tuning if it were in the vector mode.
- Acceleration and deceleration ramps (P0100 to P0103) and current limit (P0135 for V/f and VVW control, or P0169/P0170 for vector control).

Configuring the PID Function

1) **To select the especial function:** PID Regulator (P0203 = 1)

When the PID function is enabled, by setting P0203 = 1 via HMI, the following parameters are changed automatically:

- P0205 = 10 (Reading Parameter Selection 1: Setpoint PID #).
- P0206 = 9 (Reading Parameter Selection 2: Process Var. #).
- P0207 = 2 (Reading Parameter Selection 3: Motor Speed #).
- P0223 = 0 (FORWARD/REVERSE Selection - LOCAL Situation: Always FORWARD).
- P0225 = 0 (JOG Selection – LOCAL Situation: Disabled).
- P0226 = 0 (FORWARD/REVERSE Selection - REMOTE Situation: Always FORWARD).
- P0228 = 0 (JOG Selection - REMOTE Situation: Disabled).
- P0236 = 3 (AI2 Signal Function: Process Variable).
- P0265 = 22 (DI3 Function: Manual/Automatic).

The DI3 function, defined by the parameter P0265, works in the following manner:

Table 20.1 - DI3 operation mode for P0265 = 22

DI3	Operation
0 (0 V)	Manual
1 (24 V)	Automatic

2) **To define the type of PID action** that the process requires: direct or reverse. The control action must be direct (P0527 = 0) when it is necessary that the speed increases for the process variable to increase. Otherwise, select reverse (P0527 = 1). See [Figure 20.2 on page 20-4](#).

Examples:

- a) **Direct:** A pump driven by an inverter filling up a reservoir, with the PID controlling its level. In order that the level (process variable) increases, it is necessary that the flow increases, which is obtained with the increase of the motor speed.
- b) **Reverse:** A fan driven by an inverter doing the refrigeration of a cooling tower, with the PID controlling its temperature. In order that the temperature (process variable) increases, it is necessary that the ventilation be reduced, by means of the reduction of the motor speed.

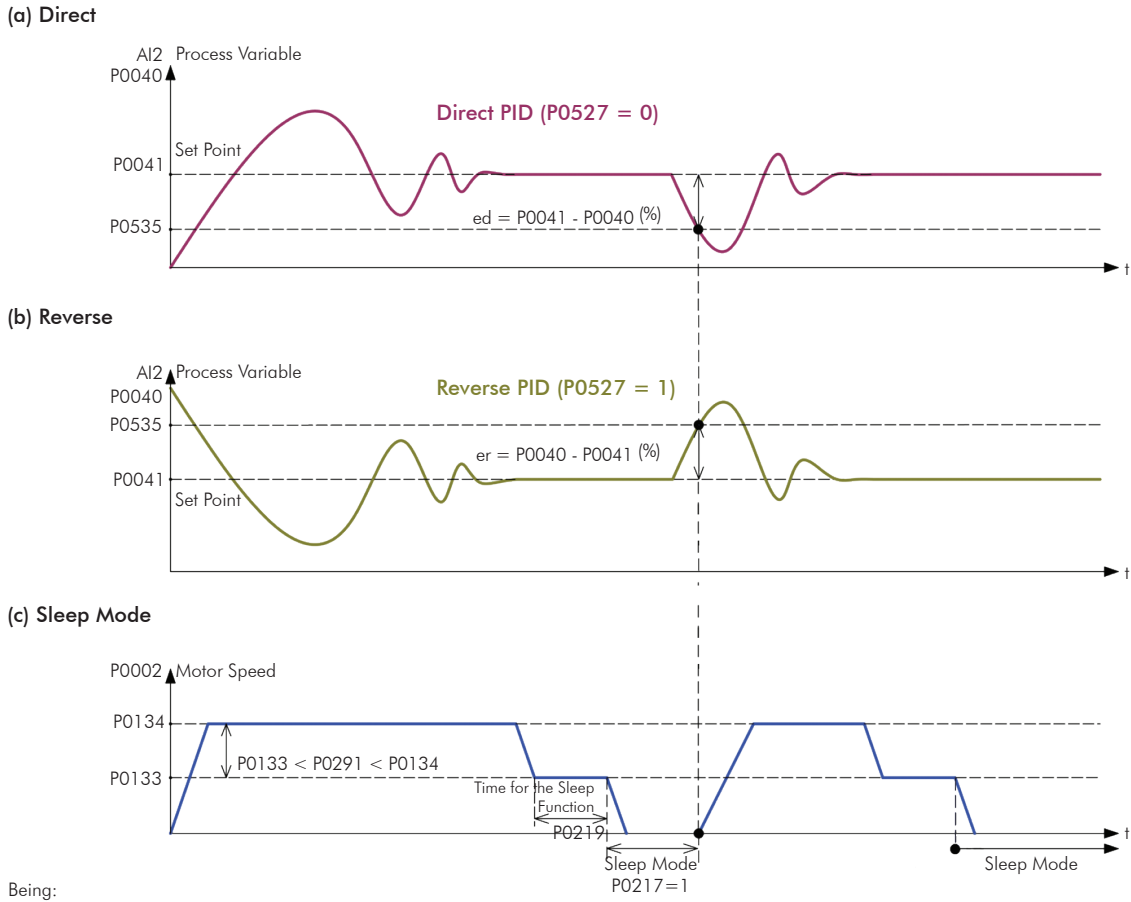

Figure 20.2 - (a) to (c) - PID action type

- 3) **To define the feedback input:** the feedback (process variable measurement) is always done via one of the analog inputs (selected at P0524). In order to make this guide easier, the AI2 input will be selected (P0524 = 1).
- 4) **To adjust the process variable scale:** the transducer (sensor) to be used for the process variable feedback must have a full scale of at least 1.1 times the highest value to be controlled.

Example: If a 20 bar pressure has to be controlled, a sensor with a full scale of at least 22 bar (1.1 x 20) must be chosen.

Once the sensor has been defined, the type of signal to be read at the input (if current or voltage) must be selected and the corresponding switch (S1 or S2) be set for that selection.

In this guide it will be assumed that the sensor signal will be 4 to 20 mA (configuring P0238 = 1 and S1.3 = ON).

Afterwards, the gain (P0237) and the offset (P0239) of the feedback signal can be adjusted so that the process variable be read at the analog input with the highest possible resolution without saturation. In this case, adjust the parameters P0237 and P0239, according to the following example.



NOTE!

In order to avoid the saturation of the feedback analog input during regulation overshoots, the signal must range from 0 to 90 % (0 to 9 V / 4 to 18 mA). This adaptation can be done by changing the gain of the analog input selected as feedback.

Example:

- Full scale of the transducer (maximum output value) = 25 bar (FS = 25);
- Operation range (range of interest) = 0 to 15 bar (OR = 15).

Opting to maintain P0237 = 1.000 and P0239 = 0 (factory setting), which is the most common for most of the applications:

- P0525 = 50 % (Keypad PID setpoint) will be equivalent to the used sensor full scale value, i.e., 0.5 x FS = 12.5 bar. Thus, the operation range (0 to 15 bar) represents 60 % of the setpoint.

If it is necessary to adjust P0237:

- Considering a gap of 10 % for the process variable measurement range (MR = 1.1 x OR = 16.5), it must be adjusted at 0 to 16.5 bar. Therefore, the parameter P0237 must be set:

$$P0237 = \frac{FS}{MR} = \frac{25}{16.5} = 1.52$$

Thus, a setpoint of 100 % represents 16.5 bar, i.e., the operation range in percentage stays from 0 to 90.9 % (OR = 15/16.5).

If offset adjustment is necessary, the parameter P0239 must be configured according to the detailed description of the [Item 13.1.1 Analog Inputs \[38\]](#) on page 13-1.

If it is wished to change the indication of the process variable on the keypad (HMI), the parameters P0528 and P0529 must be adjusted according to the transducer full scale and to the defined P0237 value (Refer to the description of those parameters at the [Section 20.6 PARAMETERS](#) on page 20-9). The parameters P0530 to P0532 can be configured to set the process variable engineering unit.

Example: If a reading of "25.0 bar" is wished for the motor maximum speed, set:

- P0528 = 250.
- P0529 = 1 (wxy.z).
- P0530 = "b".
- P0531 = "a".
- P0532 = "r".

5) **To set the reference (setpoint):** to define the operation mode (local/remote) at the parameter P0220 and the reference source at parameters P0221 and P0222, according to the desired situation.

In case the setpoint is defined via keypad (HMI), set P0525 according to the equation below:

$$\text{Setpoint (\%)} = \frac{\text{Desired value (process variable)}}{\text{Sensor full scale value}} \times \boxed{\text{Alx feedback gain}} \times 100 \%$$

Example: Given a pressure transducer with a 4 to 20 mA output and a full scale of 25 bar (i.e., 4 mA = 0 bar and 20 mA = 25 bar) and P0237=2.000. If it is wished to control 10 bar, the following setpoint must be entered:

$$\text{Setpoint (\%)} = \frac{10}{25} \times 2 \times 100 \% = 80 \%$$

In case the setpoint is defined via analog input (AI1 for instance), P0231 must be configured = 0 (AI1 Signal Function: Speed reference) and P0233 (AI1 Signal Type) according to the type of signal to be read by the input (if current or voltage).

Do not program P0221 and/or P0222 = 7 (E.P.).

6) **To set the speed limits:** Adjust P0133 and P0134 according to the application.

The readings exhibited automatically when the inverter is powered are:

- Reading 1 – P0041 "PID Setpoint".
- Reading 2 – P0040 "Process Variable".
- Reading 3 – P0002 "Motor Speed".

7) **Indication:** Refer to the [Chapter 5 PROGRAMMING BASIC INSTRUCTIONS on page 5-1](#), in this manual.

Those variables can also be visualized at the analog outputs (AOx), provided that the parameters that define the function of those outputs be programmed accordingly.

Starting up

1) **Manual Operation** (open DI3): keeping the DI3 open (Manual), check the process variable indication on the keypad (HMI) (P0040) based on an external measurement of the feedback signal value (transducer) at AI2.

Next, vary the speed reference until reaching the desired value of the process variable. Only then pass it to the automatic mode.



NOTE!

If the setpoint is defined by P0525, the inverter will set P0525 automatically with the instantaneous value of P0040 when the mode is changed from manual to automatic (provided that P0536 = 1). In this case, the commutation from manual to automatic is smooth (there is no abrupt speed change).

2) **Automatic Operation** (closed DI3): close DI3 and perform the PID regulator dynamic adjustment, i.e., of the proportional (P0520), integral (P0521) and differential (P0522), verifying if the regulation is being done correctly. Therefore, it is only necessary to compare the setpoint to the process variable checking if the values are close. Observe also how fast the motor responds to oscillations in the process variable.

It is important to point out that the PID gain setting is a step that requires attempt and error in order to get the desired response time. If the system responds rapidly and oscillates close to the setpoint, then the proportional gain is too high. If the system responds slowly and takes time to reach the setpoint, then the proportional gain is too low and must be increased. And in case that the process variable does not reach the required value (setpoint), then the integral gain must be adjusted.

As a summary of this guide, a schematic of the connections of the CFW-11 for the PID regulator application, as well as the setting of the parameters used in this example, are presented next.

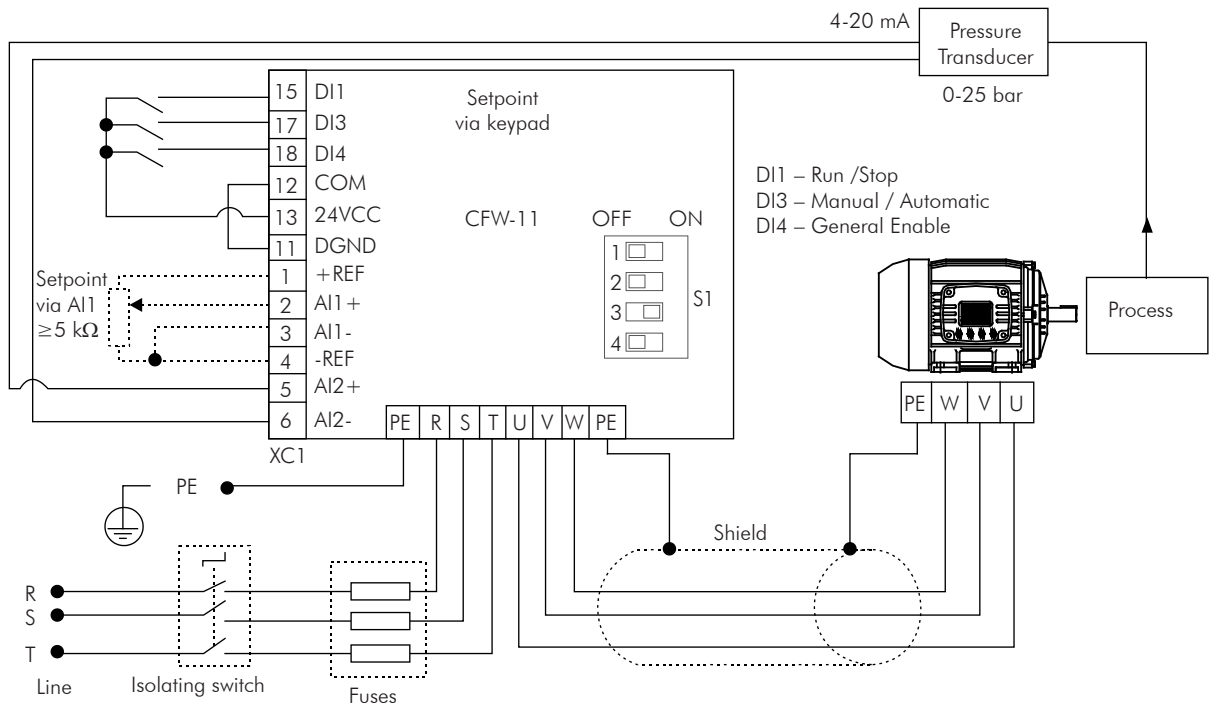

Figure 20.3 - Example of a CFW-11 application as a PID regulator

Table 20.2 - Parameter setting for the presented example

Parameter	Description
P0203 = 1	Selection of the PID regulator function
P0527 = 0 ⁽¹⁾	PID action type (Direct)
P0524 = 1 ⁽¹⁾	AI2 feedback input
P0238 = 1	AI2 signal type (4 to 20 mA)
P0237 = 1.000 ⁽¹⁾	AI2 input gain
P0239 = 0 ⁽¹⁾	AI2 input offset
P0528 = 250	Process variable scale factor
P0529 = 1 ⁽¹⁾	Process variable decimal point (wxy,z)
P0220 = 1	Operation in remote situation
P0222 = 0	Reference selection (HMI)
P0525 = 80 %	PID Setpoint
P0230 = 1	Dead zone (On)
P0205 = 10 ⁽²⁾	Reading Parameter Selection 1 (PID setpoint)
P0206 = 9 ⁽²⁾	Reading Parameter Selection 2 (Process variable)
P0207 = 2 ⁽²⁾	Reading Parameter Selection 3 (Motor Speed)
P0536 = 1 ⁽¹⁾	P0525 automatic setting (On)
P0227 = 1 ⁽¹⁾	Remote Run/Stop selection (DIx)
P0263 = 1 ⁽¹⁾	DI1 function (Run/Stop)
P0265 = 22 ⁽²⁾	DI3 function: Manual/Automatic
P0266 = 2	DI4 function (General Enable)
P0236 = 3 ⁽²⁾	AI2 input function (Process Variable)
P0520 = 1.000 ⁽¹⁾	PID proportional gain
P0521 = 0.043 ⁽¹⁾	PID integral gain
P0522 = 0.000 ⁽¹⁾	PID differential gain

⁽¹⁾ Parameters already in the factory default.

⁽²⁾ Parameter configured automatically by the inverter.

20.3 SLEEP MODE

The sleep mode is a useful resource for saving energy when using the PID regulator. Refer to the [Figure 20.2 on page 20-4](#).

In many PID applications energy is wasted by keeping the motor turning at the minimum speed when, for instance, the pressure or the tank level keeps increasing.

The sleep mode works together with the zero speed disable function.

In order to activate the sleep mode, enable the zero speed disable by programming $P0217 = 1$ (On). The disable condition is the same as for the zero speed disable without PID. Refer to the [Section 12.6 ZERO SPEED LOGIC \[35\] on page 12-10](#).

However, the $P0291$ setting must be: $P0133 < P0291 < P0134$. Refer to the [Figure 20.2 on page 20-4](#).

In order to leave the sleep mode (wake-up), when in the automatic PID mode, besides the condition programmed in $P0218$, it is necessary that the PID error (the difference between the setpoint and the process variable) be greater than the value programmed in $P0535$.



DANGER!

While in the sleep mode, the motor may turn at any moment because of the process conditions. If it is wished to handle the motor or to perform any type of maintenance, remove the power from the inverter.

20.4 MONITORING MODE SCREENS

When the PID regulator is used, the monitoring mode screen can be configured to show the main variables in a numerical form or as a bar graph, with the respective engineering units.

An example of the keypad (HMI) with that configuration can be seen in the [Figure 20.4 on page 20-8](#), where the process variable and the setpoint, both in BAR, and the motor speed in rpm are showed. Refer to the [Chapter 5 PROGRAMMING BASIC INSTRUCTIONS on page 5-1](#).



Figure 20.4 - Example of the keypad (HMI) in the monitoring mode for the PID Regulator function

20.5 CONNECTION OF A 2-WIRE TRANSDUCER

In the 2-wire configuration the transducer signal and its supply share the same wires. The [Figure 20.5 on page 20-9](#) illustrates this type of connection.

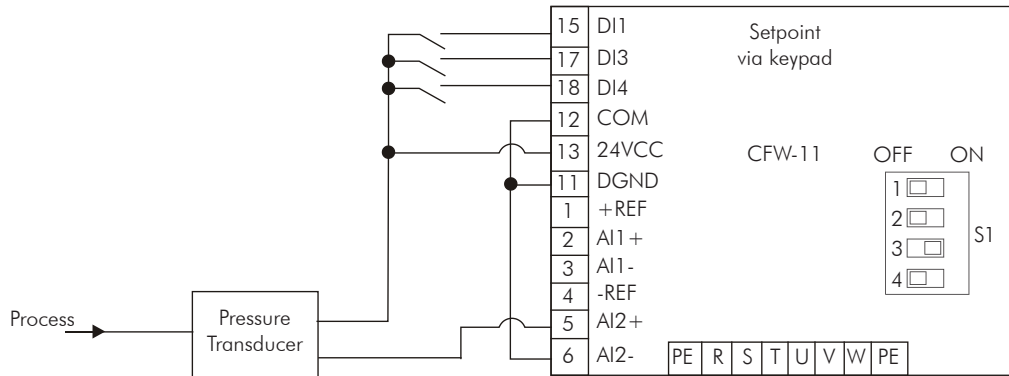

Figure 20.5 - Connection of a 2-wire transducer to the CFW-11

20.6 PARAMETERS

The parameters related to the PID Regulator [46] are now described in a detail form.

P0040 – PID Process Variable

Adjustable Range:	0.0 to 100.0 %	Factory Setting:
Properties:	RO	
Access groups via HMI:	01 PARAMETER GROUPS 46 PID Regulator	

Description:

It is a read only parameter that presents, in percentage, the PID Regulator process variable value.

P0041 – PID Setpoint Value

Adjustable Range:	0.0 to 100.0 %	Factory Setting:
Properties:	RO	
Access groups via HMI:	01 PARAMETER GROUPS 46 PID Regulator	

Description:

It is a read only parameter that presents, in percentage, the value of the PID Regulator setpoint (reference).

P0203 – Special Function Selection

Adjustable Range:	0 = None 1 = PID Regulator	Factory Setting:	0
Properties:	CFG		
Access groups via HMI:	<div style="border: 1px solid black; padding: 2px;">01 PARAMETER GROUPS</div> <div style="border: 1px solid black; padding: 2px; margin-left: 20px;">46 Regulator PID</div>		

Description:

It enables the use of the PID Regulator special function, when set to 1.

When P0203 is changed to 1, the following parameters are changed automatically:

- P0205 = 10 (Reading Parameter Selection 1).
- P0206 = 9 (Reading Parameter Selection 2).
- P0207 = 2 (Reading Parameter Selection 3).
- P0223 = 0 (FORWARD/REVERSE Selection - LOCAL Situation: Always FORWARD).
- P0225 = 0 (JOG Selection – LOCAL Situation: Disabled).
- P0226 = 0 (FORWARD/REVERSE Selection - REMOTE Situation: Always FORWARD).
- P0228 = 0 (JOG Selection – REMOTE Situation: Disabled).
- P0236 = 3 (AI2 Signal Function: Process Variable).
- P0265 = 22 (DI3 Function: Manual/Automatic).

Once the PID Regulator function is enabled, the JOG and FWD/REV functions become inactive. The enabling and Run/Stop commands are defined at P0220, P0224 and P0227.

P0520 – PID Proportional Gain

P0521 – PID Integral Gain

Adjustable Range:	0.000 to 7.999	Factory Setting:	P0520=1.000 P0521=0.043
--------------------------	----------------	-------------------------	----------------------------

P0522 – PID Differential Gain

Adjustable Range:	0.000 to 3.499	Factory Setting:	0.000
Properties:	CFG		
Access groups via HMI:	<div style="border: 1px solid black; padding: 2px;">01 PARAMETER GROUPS</div> <div style="border: 1px solid black; padding: 2px; margin-left: 20px;">46 PID Regulator</div>		

Description:

These parameters define the gains of the PID Regulator function, and must be adjusted according to the application that is being controlled.

Examples of initial settings for some applications are presented in the [Table 20.3 on page 20-11](#).

Table 20.3 - Suggestions for PID regulator gain settings

Quantity	Gains		
	Proportional P0520	Integral P0521	Differential P0522
Pneumatic system pressure	1	0.043	0.000
Pneumatic system flow	1	0.037	0.000
Hydraulic system pressure	1	0.043	0.000
Hydraulic system flow	1	0.037	0.000
Temperature	2	0.004	0.000
Level	1	See note	0.000



NOTE!

In the level control case, the setting of the integral gain will depend on the time that it takes for the reservoir to pass from the minimum acceptable level to the desired level, in the following conditions:

1. For the direct action the time must be measured with the maximum input flow and the minimum output flow.
2. For the reverse action the time must be measured with the minimum input flow and the maximum output flow.

A formula for calculating the P0521 initial value in function of the system response time is presented next:

$$P0521 = 0.02 / t$$

Where t = time (in seconds).

P0523 – PID Ramp Time

Adjustable Range:	0.0 to 999.0 s	Factory Setting:	3.0 s
Properties:			
Access groups via HMI:	<div style="border: 1px solid black; padding: 2px;">01 PARAMETER GROUPS</div> <div style="border: 1px solid black; padding: 2px; margin-left: 20px;">46 PID Regulator</div>		

Description:

This parameter adjusts the ramp time of the setpoint used in the PID regulator function. The ramp prevents abrupt setpoint transitions to reach the PID regulator.

The factory setting time (3.0 s) is normally adequate for the majority of the applications, as those listed in the [Table 20.3 on page 20-11](#).

P0524 – PID Feedback Selection

Adjustable Range:	0 = AI1 1 = AI2 2 = AI3 3 = AI4	Factory Setting:	1
Properties:	CFG		
Access groups via HMI:	<div style="border: 1px solid black; padding: 2px;">01 PARAMETER GROUPS</div> <div style="border: 1px solid black; padding: 2px; margin-left: 20px;">46 PID Regulator</div>		

Description:

It selects the regulator feedback input (process variable).

After choosing the feedback input, the function of the selected input must be programmed at P0231 (for AI1), P0236 (for AI2), P0241 (for AI3) or P0246 (for AI4).

P0525 – Keypad PID Setpoint

Adjustable Range:	0.0 to 100.0 %	Factory Setting:	0.0 %		
Properties:					
Access groups via HMI:	<table border="1"> <tr> <td>01 PARAMETER GROUPS</td> </tr> <tr> <td>46 PID Regulator</td> </tr> </table>			01 PARAMETER GROUPS	46 PID Regulator
01 PARAMETER GROUPS					
46 PID Regulator					

Description:

This parameter allows the setting of the PID Regulator setpoint through the HMI keys, provided that P0221 = 0 or P0222 = 0, and if it is operating in Automatic mode. In case it is operating in Manual mode, the reference via keypad (HMI) is adjusted at the parameter P0121.

The value of P0525 is kept at the last adjusted value (backup) even disabling or removing power from the inverter (with P0120 = 1 – Active). In this case, the value of P0525 is recorded on the EEPROM when the condition of undervoltage on the DC Link is detected.

P0527 – PID Action Type

Adjustable Range:	0 = Direct 1 = Reverse	Factory Setting:	0		
Properties:					
Access groups via HMI:	<table border="1"> <tr> <td>01 PARAMETER GROUPS</td> </tr> <tr> <td>46 PID Regulator</td> </tr> </table>			01 PARAMETER GROUPS	46 PID Regulator
01 PARAMETER GROUPS					
46 PID Regulator					

Description:

The type of PID action must be selected as "Direct" when it is necessary that the motor speed be increased so that the process variable be increased. Otherwise, "Reverse" must be selected.

Table 20.4 - PID action selection

Motor Speed	Process Variable	Select
Increases	Increases	Direct
	Diminishes	Reverse

That characteristic varies according to the process, but the direct action is more used.

In temperature or level control processes, the setting of the type of action will depend on the configuration. For instance: at the level control, if the inverter acts on the motor that extracts fluid from the reservoir, the action will be reverse, because when the level increases, the inverter must increase the motor speed so that it diminishes. In case the inverter acts on the motor that puts fluid into the reservoir, the action will be direct.

P0528 – Process Variable Scale Factor

Adjustable Range:	1 to 9999	Factory Setting:	1000
--------------------------	-----------	-------------------------	------

P0529 – Process Variable Decimal Point

Adjustable Range:	0 = wxyz 1 = wxy.z 2 = wx.yz 3 = w.xyz	Factory Setting: 1
Properties:		
Access groups via HMI:	01 PARAMETER GROUPS 46 PID Regulator	

Description:

Those parameters define how the process variable (P0040) and the PID Setpoint (P0041) will be shown.

The parameter P0529 defines the number of decimal places after the dot.

However the parameter P0528 must be adjusted in the following manner:

$$P0528 = \frac{\text{Process V. FS Indication} \times (10)^{P0529}}{\text{Analog input Gain}},$$

Where: Process V. F. S. Indication = Process Variable Full Scale value, which corresponds to 10 V/20 mA at the analog input used as feedback.

- Example 1 (0 to 25 bar Pressure Transducer – 4 to 20 mA output):
 - Desired indication: 0 to 25 bar (F.S.).
 - Feedback input: AI3.
 - AI3 gain: P0242 = 1.000.
 - AI3 signal: P0243 = 1 (4 to 20 mA).
 - P0529 = 0 (without decimal place after the dot).

$$P0528 = \frac{25 \times (10)^0}{1.000} = 25$$

- Example 2 (Factory settings):
 - Desired indication: 0.0 % to 100.0 % (F.S.).
 - Feedback input: AI2.
 - AI2 gain: P0237 = 1.000.
 - P0529 = 1 (one decimal place after the dot).

$$P0528 = \frac{100.0 \times (10)^1}{1.000} = 1000$$

P0530 – Process Variable Engineering Unit 1

P0531 – Process Variable Engineering Unit 2

P0532 – Process Variable Engineering Unit 3

Adjustable Range:	32 to 127	Factory Setting:	P0530 = 37 P0531 = 32 P0532 = 32		
Properties:					
Access groups via HMI:	<table border="1"> <tr> <td>01 PARAMETER GROUPS</td> </tr> <tr> <td>46 PID Regulator</td> </tr> </table>			01 PARAMETER GROUPS	46 PID Regulator
01 PARAMETER GROUPS					
46 PID Regulator					

Description:

The process variable engineering unit is composed of three characters, which will be applied to the indication of the parameters P0040 and P0041. The parameter P0530 defines the left most character, P0531 the center and P0532 the right most.

The characters that can be chosen correspond to the ASCII code 32 to 127.

Examples:

A, B, ..., Y, Z, a, b, ..., y, z, 0, 1, ..., 9, #, \$, %, (,), *, +, ...

- To indicate "bar":
P0530 = "b" (98)
P0531 = "a" (97)
P0532 = "r" (114)
- To indicate "%":
P0530 = "%" (37)
P0531 = " " (32)
P0532 = " " (32)

P0533 – PVx Process Variable

P0534 – PVy Process Variable

Adjustable Range:	0.0 to 100.0 %	Factory Setting:	P0533 = 90.0 % P0534 = 10.0 %		
Properties:					
Access groups via HMI:	<table border="1"> <tr> <td>01 PARAMETER GROUPS</td> </tr> <tr> <td>46 PID Regulator</td> </tr> </table>			01 PARAMETER GROUPS	46 PID Regulator
01 PARAMETER GROUPS					
46 PID Regulator					

Description:

Those parameters are used in the functions of the digital/relay outputs, with the purpose of signaling/alarm, and they will indicate:

- Process Variable > VPx and
- Process Variable < VPy

The values are in percentage of the process variable full scale:

$$P0040 = \frac{(10)^{P0529}}{P0528} \times 100 \%$$

P0535 – Wake Up Band

Adjustable Range:	0 to 100 %	Factory Setting:	0 %
Properties:			
Access groups via HMI:	<div style="border: 1px solid black; padding: 2px; display: inline-block;">01 PARAMETER GROUPS</div> <div style="border: 1px solid black; padding: 2px; display: inline-block; margin-left: 20px;">46 PID Regulator</div>		

Description:

The parameter P0535 works together with the parameter P0218 (Condition to Leave the Zero Speed Disable), giving the additional condition for leaving the Zero Speed Disable. Therefore, it is necessary that the PID error (the difference between the setpoint and the process variable) be higher than the value programmed in P0535 so that the inverter runs the motor again.

P0536 – P0525 Automatic Setting

Adjustable Range:	0 = Off 1 = On	Factory Setting:	1
Properties:			
Access groups via HMI:	<div style="border: 1px solid black; padding: 2px; display: inline-block;">01 PARAMETER GROUPS</div> <div style="border: 1px solid black; padding: 2px; display: inline-block; margin-left: 20px;">46 PID Regulator</div>		

Description:

When the PID regulator setpoint is via keypad (HMI) (P0221/P0222 = 0) and P0536 = 1 (On), by commutating from manual to automatic the value of the process variable (P0040) will be loaded into P0525. Therefore PID oscillations during the commutation from manual to automatic are avoided.

P0538 – Hysteresis VPx/VPy

Adjustable Range:	0.0 to 5.0 %	Factory Setting:	1.0 %
Properties:			
Access groups via HMI:	<div style="border: 1px solid black; padding: 2px; display: inline-block;">01 PARAMETER GROUPS</div> <div style="border: 1px solid black; padding: 2px; display: inline-block; margin-left: 20px;">46 PID Regulator</div>		

Description:

The programmed hysteresis value will be used in the following digital and relay output functions:

Function: P02xy = (22) Process Variable > Vpx, and

P02xy = (23) Process Variable < Vpy.

Where: Vpx = P0533 ± P0538; Vpy = P0534 ± P0538, and P02xy = P0275, ..., P0280.

20.7 ACADEMIC PID

The controller implemented in the CFW-11 is of the academic type. The equations that characterize the Academic PID, which is the base of this function algorithm, are presented next.

The transfer function in the Academic PID regulator frequency dominion is:

$$y(s) = K_p \times e(s) \times \left[1 + \frac{1}{sT_i} + sT_d \right]$$

By replacing the integrator by a sum and the derivative by the incremental quotient, one gets an approximation for the discrete transfer equation (recursive) presented next:

$$y(kT_a) = y(k-1)T_a + K_p[(e(kT_a) - e(k-1)T_a) + K_i e(k-1)T_a + K_d(e(kT_a) - 2e(k-1)T_a + e(k-2)T_a)]$$

Being:

K_p (Proportional gain): $K_p = P0520 \times 4096$.

K_i (Integral gain): $K_i = P0521 \times 4096 = [T_a/T_i \times 4096]$.

K_d (Differential gain): $K_d = P0522 \times 4096 = [T_d/T_a \times 4096]$.

$T_a = 0.02\text{sec}$ (PID regulator sampling time).

SP^* : reference, it has 13 bits (0 to 8191) maximum.

X : process variable (or controlled), read by means of one of the analog inputs (Alx), it has 13 bits maximum.

$y(kT_a)$: PID actual output, it has 13 bits maximum.

$y(k-1)T_a$: PID previous output.

$e(kT_a)$: actual error $[SP^*(k) - X(k)]$.

$e(k-1)T_a$: previous error $[SP^*(k-1) - X(k-1)]$.

$e(k-2)T_a$: error two samples before $[SP^*(k-2) - X(k-2)]$.

21 PM VECTOR CONTROL

21.1 PERMANENT MAGNET SYNCHRONOUS MOTORS (PMSM)

Permanent magnet synchronous motors are alternating current motors with three-phase stator winding, similar to the induction motor, and permanent magnet rotor. PMSM for industrial applications have sinusoidal CEMF and feeding current, so that the developed torque is smooth. The CFW-11 is prepared to drive Wmagnet line motors, which present a salient pole construction (interior magnets).

Flat pole motors (surface magnets) and motors from other manufactures can be used upon consultation.

Main characteristics of the Wmagnet motor line:

- ☑ Lq inductance bigger than the Ld, because of the rotor saliencies that generate the reluctance torque.
- ☑ Field weakening range: broad ([1...2] x the nominal speed).
- ☑ More protection of the magnets against centrifugal force.
- ☑ Higher efficiency than the induction motor (it does not present $R I^2$ losses in the rotor, which allows higher temperature rise, less volume and less weight. If compared to an equivalent induction motor, the Wmagnet motor volume can be up to 47 % less, resulting in a high volume/torque ratio, and a reduction of 36 % in the weight. For an identical torque/power ratio, by reducing the frame size the ventilation system is also reduced.

The Wmagnet motors can be used where speed variation with constant torque and high efficiency are required, for instance with compressors, exhausting fans, pumps and conveyors. They can also be used in lifts, where the precise control at low speeds, smooth torque, low vibration and low noise levels, are fundamental.

21.2 SENSORLESS PM CONTROL AND PM WITH ENCODER

The vector control developed for driving the Wmagnet motor line has a structure very similar to the one used for the induction motors. Refer to the [Figure 21.1 on page 21-2](#) and [Figure 21.2 on page 21-3](#).

In the constant torque region, the control determines the current reference i_d suitable for the specified motor. Therefore, the reluctance torque is added to the torque produced by the magnets and the motor accelerates with the maximum N.m/A ratio and fast dynamic response. Above the nominal speed, the control applies field weakening through the control of the armature reaction, so that the motor accelerates with nominal voltage and constant power.

21.2.3 Modified Functions

Almost all the functions presented in this manual remain active when the options 6 or 7 are programmed in P0202. The functions no longer active or that suffered any modification are described in the [Section 21.3 PROGRAMMING BASIC INSTRUCTIONS – INCOMPATIBILITY BETWEEN PARAMETERS](#) on page 21-4 to [Section 21.9 FAULTS AND ALARMS](#) on page 21-18.

Neither are the inactive functions (e.g., running the self-tuning - P0408), nor the parameters associated to those functions (e.g., I/f control - P0182 and P0183), visualized on the HMI.

21.3 PROGRAMMING BASIC INSTRUCTIONS – INCOMPATIBILITY BETWEEN PARAMETERS

Refer to [Section 5.7 INCOMPATIBILITY BETWEEN PARAMETERS](#) on page 5-12.

21.4 INVERTER MODEL AND ACCESSORIES IDENTIFICATION

P0297 – Switching Frequency

Adjustable Range:	0 = 1.25 kHz 1 = 2.5 kHz 2 = 5.0 kHz 3 = 10.0 kHz 4 = 2 kHz	Factory Setting:	According to inverter model
Properties:	CFG		
Access groups via HMI:	<div style="border: 1px solid black; padding: 2px; display: inline-block;">01 PARAMETER GROUPS</div> <div style="border: 1px solid black; padding: 2px; display: inline-block; margin-left: 20px;">42 Inverter Data</div>		

Description:

Refer to the allowed current for switching frequencies different from the default, in the tables available in chapter 8 - Technical Specifications, of the CFW-11 user's manual.

The inverter switching frequency can be adjusted according to the needs of the application.

Higher switching frequencies imply in lower motor acoustic noise, however, the selection of the switching frequency results in a compromise between the motor acoustic noises, the losses in the inverter IGBTs and the maximum allowed currents.

The reduction of the switching frequency reduces the earth leakage current, being able to avoid the actuation of the faults F074 (Ground Fault) or F070 (Output Overcurrent/Short Circuit).

Note: The option 0 (1.25 kHz) is only allowed for the V/f or VVW control modes (P0202 = 0, 1, 2 or 5).
Option 3 (10 kHz) is not allowed in the PM control mode (P0202 = 7).

21.5 TORQUE CONTROL

It is possible to use the inverter to control the motor torque when in vector mode. One of the configurations consists in keeping the speed regulator saturated and the other in selecting between torque and speed control through a digital input.

Torque control range: 10 % to 180 %.

Accuracy: ± 5 % of the rated torque.

When the speed regulator is positively or negatively saturated, then P0169 and P0170 limit the torque current, respectively.

The torque, in percentage, at the motor shaft (showed at P0009) is given by:

$$T_{\text{motor}} = \frac{I_{q^*} \times P0401}{I_{\text{HD}}}$$

Where I_{q^*} (in Volts) is the value read at the analog outputs AO1... AO4.



Settings for torque control:

Torque limitation:

1. Via parameters P0169, P0170 (the keypad (HMI), Serial or Fieldbus). Refer to the [Item 11.8.6 Torque Current Limitation \[95\] on page 11-29](#).
2. Through the analog inputs AI1, AI2, AI3 or AI4. Refer to the [Item 13.1.1 Analog Inputs \[38\] on page 13-1](#), option 2 (maximum torque current).

Speed reference:

3. Set the speed reference 10 %, or more, higher than the working speed. This assures that the speed regulator output remains saturated at the maximum value allowed by the torque limit adjustment.



NOTE!

The motor rated current must be equivalent to the inverter rated current, in order that the control has the best possible accuracy.



NOTE!

The torque control with saturated speed regulator has a protection function (to limit the motor speed without causing a fault). For a winder, for instance, when the material being wound brakes, the regulator leaves the saturated condition and starts controlling the motor speed, which will be kept at the speed reference value.

21.6 MOTOR DATA [43] AND SELF-TUNING [05] AND [94]

The parameters for the used motor data setting are listed in this group. They must be adjusted according to the motor nameplate data, except P0405.

P0398 – Motor Service Factor

P0400 – Motor Rated Voltage

P0401 – Motor Rated Current

P0402 – Motor Rated Speed

Adjustable Range:	0 to 18000 rpm	Factory Setting:	1750 rpm (1458 rpm)
Properties:	CFG		
Access groups via HMI:	<div style="border: 1px solid black; padding: 2px; display: inline-block;">01 PARAMETER GROUPS</div> <div style="border: 1px solid black; padding: 2px; display: inline-block; margin-left: 20px;">43 Motor Data</div>		

Description:

Adjust it according to the used motor nameplate data.
 For PM motor control the adjustable range goes from 0 to 18000 rpm.

P0403 – Motor Rated Frequency

Adjustable Range:	0 to 300 Hz	Factory Setting:	60 Hz (50 Hz)
Properties:	CFG		
Access groups via HMI:	<div style="border: 1px solid black; padding: 2px; display: inline-block;">01 PARAMETER GROUPS</div> <div style="border: 1px solid black; padding: 2px; display: inline-block; margin-left: 20px;">43 Motor Data</div>		

Description:

It is automatically adjusted according to the expression:

$$P0403 = \frac{P0402 \times P0431 [\text{Hz}]}{120}$$

P0404 – Motor Rated Power

P0405 – Number of Encoder Pulses

P0408 - Run Self-Tuning

The function is inactive.

P0409 – Motor Stator Resistance (Rs)

Adjustable Range:	0.000 to 9.999 ohm	Factory Setting:	0.000 ohm
Properties:	CFG, PM, Vector and VW		
Access groups via HMI:	01 PARAMETER GROUPS 29 Vector Control	or	05 SELF-TUNING 94 Self-tuning

Description:

Value obtained from the motor data sheet. If this information is not available, use the factory setting.

P0430 – PM Type

Adjustable Range:	0 = Factory Setting 1 = Cooling Tower	Factory Setting:	0
Properties:	CFG and PM		
Access groups via HMI:	01 PARAMETER GROUPS 43 Motor Data		

Description:

When parameterized for standard Wmagnet motor (P0430 = 0), the parameterization of P0433, P0434 and P0435 will be permitted. When P0430 = 1, the parameterization of P0442, P0443 and P0444 will be permitted.

P0431 – Number of Motor Pole

Adjustable Range:	2 to 24	Factory Setting:	6
Properties:	PM		
Access groups via HMI:	01 PARAMETER GROUPS 43 Motor Data		



NOTE!

Set this parameter in 6 for the standard Wmagnet motor line (P0402 = 1800 rpm or 3600 rpm). Other values are possible for special motors.

P0433 – Lq Inductance

P0434 – Ld Inductance

Adjustable Range:	0 to 100.00 mH	Factory Setting:	0.00 mH
Properties:	PM		
Access groups via HMI:	<div style="border: 1px solid black; padding: 2px; display: inline-block;">01 PARAMETER GROUPS</div> <div style="border: 1px solid black; padding: 2px; display: inline-block; margin-left: 20px;">43 Motor Data</div>		

P0442 – Inductance Lq - CT

P0443 – Inductance Lq - CT

Adjustable Range:	0.0 to 400.0 mH	Factory Setting:	0.0 mH
Properties:	CFG and PM		
Access groups via HMI:	<div style="border: 1px solid black; padding: 2px; display: inline-block;">01 PARAMETER GROUPS</div> <div style="border: 1px solid black; padding: 2px; display: inline-block; margin-left: 20px;">43 Motor Data</div>		

Description:

Adjust them according to the motor nameplate data. If these pieces of information are not available, keep the default value.

The view of parameters P0433, P0434, P0442 and P0443 will depend on the value set in P0430.



NOTE!
 The use of the default value causes:

1. It increases the output current, because the motor in those conditions does not produce the reluctance torque. The increase of the output current may cause increase in the motor temperature.
2. It prevents the motor operation in the field-weakening region.

P0435 – Ke Constant

Adjustable Range:	0 to 600.0	Factory Setting:	100.0 V/krpm
Properties:	CFG and PM		
Access groups via HMI:	<div style="border: 1px solid black; padding: 2px; display: inline-block;">01 PARAMETER GROUPS</div> <div style="border: 1px solid black; padding: 2px; display: inline-block; margin-left: 20px;">43 Motor Data</div>		

P0444 – Constant Ke – CT

Adjustable Range:	0 to 3000	Factory Setting:	100 V/krpm
Properties:	CFG and PM		
Access groups via HMI:	01 PARAMETER GROUPS		
	43 Motor Data		

Note: ke is the generated voltage constant. It is a characteristic of the motor, which determines the voltage generated as a function of the motor speed. The used engineering unit is V/krpm (Volts/1000 rpm).

Description:

Values obtained from the motor nameplate data. The view of parameters P0435 and P0444 will depend on the value set in P0430.

**NOTE!**

If this information is not available, it can be obtained using the following procedure:

1. Drive the motor with no load, setting P0121 = 1000 rpm.
2. After reaching the speed set, read the value of P0007.
3. Disable the inverter and set P0435 or P0444 (depending on the value set in P0430) with the value read in P0007.

21.7 PM VECTOR CONTROL [29]**21.7.1 Speed Regulator [90]**

The parameters related to the CFW-11 speed regulator are presented in this group.

P0160 – Speed Regulator Configuration**P0161 – Speed Regulator Proportional Gain****P0162 – Speed Regulator Integral Gain****P0163 – Local Reference Offset****P0164 – Remote Reference Offset****P0165 – Speed Filter****P0166 – Speed Regulator Differential Gain**

21.7.2 Current Regulator [91]

The parameters related to the CFW-11 current regulator are presented in this group.

P0438 – Iq Current Regulator Proportional Gain

P0440 – Id Current Regulator Proportional Gain

Adjustable Range:	0.00 to 1.99	Factory Setting:	P0438 = 0.80 P0440 = 0.50
--------------------------	--------------	-------------------------	------------------------------

P0439 – Iq Current Regulator Integral Gain

P0441 – Id Current Regulator Integral Gain

Adjustable Range:	0 to 1.999	Factory Setting:	0.005
--------------------------	------------	-------------------------	-------

Properties: PM

Access groups via HMI:	01 PARAMETER GROUPS
	29 Vector Control
	92 Flux Regulator

Description:

Parameters P0438, P0439, P0440 and P0441 are automatically set as a function of parameter P0402.

21.7.3 Flux Regulator [92]

P0190 – Maximum Output Voltage

Adjustable Range:	0 to 690 V	Factory Setting:	P0296. Automatic setting during the Oriented Start-up Routine: P0400
--------------------------	------------	-------------------------	---

Properties: PM and Vector

Access groups via HMI:	01 PARAMETER GROUPS
	29 Vector Control
	92 Flux Regulator

Description:

This parameter defines the value of the maximum output voltage. Its default value is defined for the condition of the nominal supply voltage.

The voltage reference used in the "Maximum Output Voltage" regulator is directly proportional to the supply voltage.

If the supply voltage increases, the output voltage can increase up to the value adjusted in the parameter P0400 - Nominal Motor Voltage.

If the supply voltage decreases, the output voltage will decrease in the same proportion.



NOTE!

When P0202 = 6 or 7, during the Oriented Start-up routine the parameter P0190 will be set to 0.95 x P0400.



NOTE!

Parameters from P0175 to P0189 are inactive.

21.7.4 Torque Current Limitation [95]

P0169 – Maximum "+" Torque Current

P0170 – Maximum "-" Torque Current

Adjustable Range:	0.0 to 350.0 %	Factory Setting:	125.0 %
Properties:	PM and Vector		
Access groups via HMI:	<div style="border: 1px solid black; padding: 2px; margin-bottom: 2px;">01 PARAMETER GROUPS</div> <div style="border: 1px solid black; padding: 2px; margin-bottom: 2px; margin-left: 20px;">29 Vector Control</div> <div style="border: 1px solid black; padding: 2px; margin-left: 40px;">95 Torque Curr. Limit.</div>		

Description:

These parameters limit the value of the motor current component that produces positive torque (P0169) and negative torque (P0170). The setting is expressed in percentage of the motor rated current (P0401).

In case that any Analog Input (Alx) is programmed for the option 2 (Maximum Torque Current), P0169 and P0170 become inactive and the current limitation will be given by the Alx. In this case, the limitation value can be monitored at the parameter correspondent to the programmed Alx (P0018 ... P0021).

In the torque limitation condition the motor current can be calculated by:

$$I_{motor} = \frac{P0169 \text{ or } P0170^{(*)}}{100} \times P0401$$

The maximum torque developed by the motor is given by:

$$T_{motor} (\%) = P0169 \text{ or } P0170$$

(*) If the current limitation is provided by an analog input, replace P0169 or P0170 by P0018, P0019, P0020 or P0021, according to the programmed Alx. For more details, refer to the [Item 13.1.1 Analog Inputs \[38\]](#) on page 13-1.



NOTE!

Parameters P0171, P0172 and P0173 are inactive.

P0174 – Minimum Torque Current

Adjustable Range:	0.0 to 350.0 %	Factory Setting:	30.0 %
Properties:	Sless		
Access groups via HMI:	<div style="border: 1px solid black; padding: 2px; margin-bottom: 2px;">01 PARAMETER GROUPS</div> <div style="border: 1px solid black; padding: 2px; margin-bottom: 2px; margin-left: 20px;">29 Vector Control</div> <div style="border: 1px solid black; padding: 2px; margin-left: 40px;">95 Torque Curr.Limit</div>		

Description:

This parameter defines the minimum value of torque + (P0169) and torque – (P0170) limitations for sensorless control. Values of P0169 and P0170 smaller than P0174 are ignored, and in these cases the valid value for the maximum torque current is defined by the value of P0174.

21.7.5 DC Link Regulator [96]

For the deceleration of high inertia loads with short deceleration times, the CFW-11 has available the DC Link Regulation function, which avoids DC link overvoltage (F022) inverter tripping.

P0184 – DC Link Regulation Mode

Adjustable Range:	0 = With losses 1 = Without losses 2 = Enable/Disable via Dlx	Factory Setting:	1
Properties:	CFG and Vector		
Access groups via HMI:	<div style="border: 1px solid black; padding: 2px; margin-bottom: 2px;">01 PARAMETER GROUPS</div> <div style="border: 1px solid black; padding: 2px; margin-left: 20px;">29 Vector Control</div> <div style="border: 1px solid black; padding: 2px; margin-left: 40px;">96 DC Link Regulator</div>		

Description:

It enables or disables the Without losses function of the DC Link Regulator, according to the next table.

Table 21.1 - DC Link Regulation Modes

P0184	Action
0 = With losses (Optical Braking)	INACTIVE. If it is used, F022 (overvoltage) may occur during the speed reduction
1 = Without losses	Automatic control of the deceleration ramp. The Optical Braking is inactive. The deceleration ramp is automatically adjusted in order to keep the DC link below the level adjusted in P0185. This procedure avoid the overvoltage fault at the DC link (F022). It can also be used with accentric loads
2 = Enable/Disable via Dlx	<input checked="" type="checkbox"/> Dlx = 24 V: Braking actuates as described for P0184 = 1 <input checked="" type="checkbox"/> Dlx = 0 V: The Without Losses Braking stays inactive. The DC link voltage will be controlled by the parameter P0153 (Dynamic Braking)

P0185 – DC Link Voltage Regulation Level

P0186 – DC Link Voltage Regulation Proportional Gain

P0187 – DC Link Voltage Regulation Integral Gain

21.7.6 Flying Start/Ride-Through [44]

P0321 – DC Link Power Loss

P0322 – DC Link Ride-Through

P0323 – DC Link Power Back

P0325 – Ride-Through Proportional Gain

P0326 – Ride-Through Integral Gain

Adjustable Range:	0.000 to 9.999	Factory Setting:	0.128
Properties:	PM and Vector		
Access groups via HMI:	<div style="border: 1px solid black; padding: 2px; display: inline-block;">01 PARAMETER GROUPS</div> <div style="border: 1px solid black; padding: 2px; display: inline-block; margin-left: 20px;">44 FlyStart/RideThru</div>		

Description:

These parameters configure the vector mode Ride-Through PI controller, which is responsible for keeping the DC link voltage at the level set in P0322.

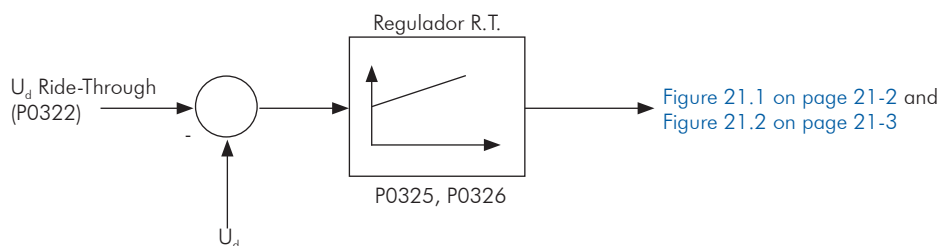

Figure 21.3 - Ride-Through PI controller

Normally the factory settings for P0325 and P0326 are adequate for the majority of the applications. Do not change these parameters.

21.7.7 DC Braking [47]

21.7.8 Encoder Zero Position Search

These functions are inactive.

21.8 PM VECTOR CONTROL MODE START-UP

NOTE! Read the entire CFW-11 user's manual before installing, powering up or operating the inverter.

Sequence for the installation, verification, and start-up:

- a) Install the inverter according to the CFW-11 user's manual chapter 3 - Installation and Connection - wiring all the power and control connection.

- b) Prepare the drive system and power up the inverter according to the CFW-11 user's manual section 5.1 - Prepare for Start-up.
- c) Set the password P0000 = 5, according to the [Section 5.3 PASSWORD SETTING IN P0000 on page 5-3](#), in this manual.
- d) Access P0317 and change its content to 1, in order to initiate the "Oriented Start-up" routine. Adjust the inverter to operate with the line and the motor of the application.

The Oriented Start-up [2] routine presents the main parameters in a logical sequence on the HMI. The programming of those parameters prepares the inverter for the operation with the application line and motor. Look at the sequence in the [Figure 21.4 on page 21-17](#).

The programming of the parameters presented in the group [2] causes the automatic modification of the contents of other inverter parameters or internal variables, as showed in the [Figure 21.4 on page 21-17](#), which results in a stable control operation, with values suitable to obtain the best motor performance.

During the "Oriented Start-up" routine, the "Config" (Configuration) status is indicated on the top left part of the HMI display.



Parameters related to the motor:

Program the parameters P0398, P0400 ... P0435 directly with the motor nameplate data.

- e) Adjust specific parameters and functions, digital and analog inputs and outputs, HMI keys, according to the application needs.



For applications:

- That are simple, which allow the use of digital and analog inputs and outputs with their factory settings, and the use of the Basic Application [04] parameter group, refer to the item 5.2.3 - Setting Basic Application Parameters, of the CFW-11 user's manual.
- That require only the digital and analog inputs and outputs with programming different from the factory settings, use the Menu "I/O Configuration" [07].
- That need functions as Dynamic Braking [28] and Ride-Through [44], access them through the group of parameters menu Parameter Groups [01].

f) Operation test:

1. Adjust the speed reference (P0121) at the rated speed (P0402) and run the motor without load;
2. With the motor running at the nominal speed (P0402), increase the load slowly until reaching the rated current (P0401).

If any of the faults or symptoms listed next occurs during the execution of steps 1 or 2, try to eliminate it by using the procedures described for each situation. If more than one procedure exists, test each one separately and in the presented order:

- F071 at the beginning of the acceleration ramp

1. Increase the acceleration ramp time (P0100 or P0102).
2. Increase the speed regulator proportional gain (P0161) in steps of 1.0, up to the maximum of 20.0.
3. Increase the proportional gain of the iq current regulator (P0438) in steps of 0.10 up to the maximum of 1.50.
4. Verify the P0435 setting.
5. Undo steps 2 and 3.
6. Decrease the proportional gain of the speed regulator (P0161) in steps of 1.0 up to a minimum of 4.0 .

- F071 at the end of the acceleration ramp:

1. Decrease proportional gain of the id current regulator (P0440) in steps of 0.1 up to a minimum of 0.2.
2. Decrease the proportional gain of the speed regulator (P0161) in steps of 1.0 up to a minimum of 4.0.
3. Undo steps 1 and 2.
4. Increase the proportional gain of the id current regulator (P0440) in steps of 0.1 up to a maximum of 0.8.
5. Decrease by 5 % the standard value for maximum output voltage (P0190).
6. Decrease by 5 % the speed reference (P0121).
7. Decrease the load.

- DC bus overvoltage (F022)

1. Adjust P0185 as suggested in the [Table 11.9 on page 11-31](#).

- Motor overspeed (F150)

1. Adjust the speed regulator gains according to the description in the [Item 11.8.1 Speed Regulator \[90\] on page 11-17](#).
2. Increase the iq proportional gain (P0438) in steps of 0.10 up to the maximum of 1.50.

- Speed oscillation

1. Follow the procedure for the speed regulator optimization, described in the [Item 11.8.1 Speed Regulator \[90\] on page 11-17](#).

- Motor vibration (it generally occurs when P0202 = 7)

1. Decrease the id proportional gain (P0440) in steps of 0.05 down to the minimum of 0.2.
2. Decrease reduce the iq proportional gain (P0438) in steps of 0.05 down to the minimum of 0.5.
3. Decrease the speed proportional gain (P0161) in steps of 1.0 down to the minimum of 4.

- Motor will not accelerate (PM with encoder)

- Check that the identification of the motor cables matches the power terminals U/T1, V/T2 and W/T3 of the inverter. Otherwise, make the connections again.

- Motor shaft spins in the wrong direction (sensorless PM)

- Check that the identification of the motor cables matches the power terminals U/T1, V/T2 and W/T3 of the inverter. Otherwise, make the connections again.

- Motor effective speed (P0002) is limited below the maximum speed (P0134)

Parameter P0134 is limited automatically by:

$$P0134 = U_{d_{max}} \cdot 636 / P0435.$$

P0296	220/230 V	380 V...480 V	500 V...600 V	660/690 V
$U_{d_{max}}$	400 V	800 V	1000 V	1200 V

Seq.	Action/Result	Display Indication
1	- Monitoring Mode. - Press "Menu" (right "soft key").	
2	- The group "00 ALL PARAMETERS" is already selected.	
3	- The group "01 PARAMETER GROUPS" is selected.	
4	- The group "02 ORIENTED START-UP" is then selected. - Press "Selec."	
5	- The parameter "Oriented Start-up P0317: No" is already selected. - Press "Selec."	
6	- The content of "P0317 = [000] No" is showed.	
7	- The content of the parameter is changed to "P0317 = [001] Yes". - Press "Save".	
8	- At this moment, the Oriented Start-up routine is initiated and the "Config" status is indicated at the top left part of the keypad (HMI). - The parameter "Language P0201: English" is already selected. - If necessary, change the language by pressing "Selec.", next and to select the language and then press "Save".	

Seq.	Action/Result	Display Indication
9	- Set the content of P0202 pressing "Selec." - Next press until selecting the option: "[007] Sensorless PM" or "[006] PM with Encoder". - Then press "Save".	
10	- If necessary, change the content of P0296 according to the used line voltage. Therefore press "Selec.". This change will affect P0151, P0153, P0185, P0321, P0322, P0323 and P0400.	
11	- If necessary, change the content of P0298 according to the inverter application. Therefore press "Selec.". This change will affect P0156, P0157, P0158, P0169, P0170, P0401 and P0404. The actuation time and level of the IGBTs overload protection will also be affected.	
12	- If necessary, adjust the content of P0398 according to the motor service factor. Therefore press "Selec.". This change will affect the current value and the time for the actuation of the motor overload function.	
13	If necessary, change the content of P0400 according to the rated motor voltage. Therefore press "Selec.". This change will affect P0190.	











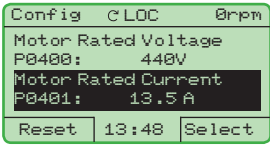

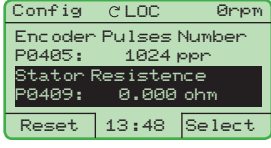

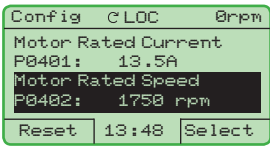

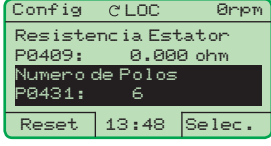

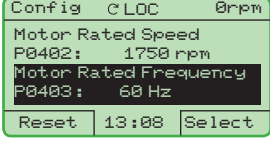
Seq.	Action/Result	Display Indication	Seq.	Action/Result	Display Indication
14	- If necessary, change the content of P0401 according to the rated motor current. Therefore press "Selec.". This change will affect P0156, P0157 and P0158. 		19	- Set P0409 according to the motor data sheet. Therefore, press "Selec.". - If the information is not available, keep the setting equal to zero. 	
15	- If necessary, change the content of P0402 according to the rated motor speed. Therefore press "Selec.". This change will affect P0122 to P0131, P0133, P0134, P0208, P0288, P0289 and P0403. 		20	Adjust P0431 equal to 6 for the standard Wmagnet motor. Therefore press "Selec.". This change will affect P0403. 	
16	- P0403 is automatically adjusted according to: $P0403 = \frac{P0402 \times P0431}{120}$ Therefore press "Selec.". 		21	Adjust P0433 according to the nameplate data. Therefore press "Selec.". 	
17	- If necessary, change the content of P0404 according to the rated motor power. Therefore press "Selec.". 		22	Adjust P0434 according to the nameplate data. Therefore press "Selec.". 	
18	- This parameter will only be visible if the encoder board ENC1 or the PLC11 module is connected to the inverter. - If there is an encoder connected to the motor, change P0405 according to its number of pulses per revolution. Therefore press "Selec.". 		23	Adjust P0435 according to the nameplate data. Therefore press "Selec.". 	

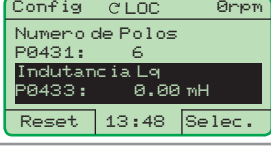
Figure 21.4 - PM vector mode oriented Start-up

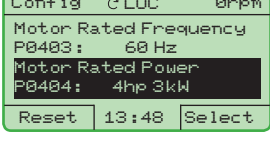
21.9 FAULTS AND ALARMS

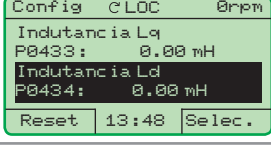
When the control mode is PM with encoder (P0202 = 6), fault reset will only be accepted with stopped motor. Except for the F079 (Encoder fault) reset, which could occur with the motor shaft in movement; however, the motor must be stopped in order to avoid operation problems after the fault reset.

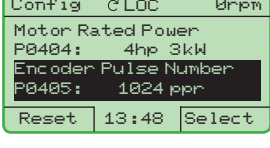
21.10 READ-ONLY PARAMETERS [09]

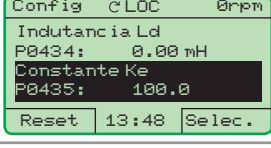
P0009 – Motor Torque

Adjustable Range:	-1000.0 to 1000.0 %	Factory Setting:
Properties:	RO	
Access groups via HMI:	09 READ ONLY PARAMETERS	

Description:

It indicates the torque developed by the motor, as a percentage of the motor rated current (P0401). By using the analog output AO1 or AO2 (modulus), AO3 or AO4 programmed to show the torque current reference (I_q^*), the motor torque can be calculated through the following formula:

$$T_{\text{motor}} = \{I_q^* \times P0401 \times 20 [\%]\} / I_{\text{HD}}$$

Where:

I_q^* in (Volts).

I_{HD} is the inverter HD current (P0295).

21.11 SPEED LIMITS

P0134 - Maximum Speed Reference Limit



Parameters related to the motor:

The maximum allowed speed is automatically set in the value defined by:

$$P0134_{\text{limit}} = U_{\text{d}_{\text{max}}} \times 636 / P0435.$$

Table 21.2 - Maximum dc link voltage

P0296	220/240 V	380 V...480 V	500 V...600 V	660/690 V
$U_{\text{d}_{\text{max}}}$	400 V	800 V	1000 V	1200 V



WEG Drives & Controls - Automação LTDA.
Jaraguá do Sul - SC - Brazil
Phone 55 (47) 3276-4000 - Fax 55 (47) 3276-4020
São Paulo - SP - Brazil
Phone 55 (11) 5053-2300 - Fax 55 (11) 5052-4212
automacao@weg.net
www.weg.net