

Motores Industriais
Motores Comerciais &
Appliance

Automação

Digital &
Sistemas

Energia

Transmissão &
Distribuição

Tintas

TOMADAS & INTERRUPTORES

Linhas Klin e Padrão



Driving efficiency and sustainability





SUMÁRIO

Linhas KLIN e Padrão

04

Placas KLIN

06

Itens sem placa KLIN

08

Conjuntos montados KLIN

10

Placas padrão

13

Itens sem placa padrão

15

Dimensões (mm)

17

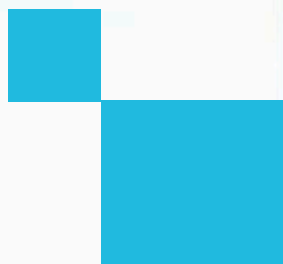

TOMADAS & INTERRUPTORES

Linhas KLIN e Padrão



Klin e Padrão

DESIGN ATEMPORAL EM LINHAS TRADICIONAIS



A PRATICIDADE E DURABILIDADE QUE SEU DIA A DIA NECESSITA.

Inspiradas na harmonia das formas naturais e cantos arredondados, essas duas linhas se destacam no mercado por sua história, pois seus conjuntos se adequam a qualquer situação dentro de ambientes residenciais ou comerciais.

Produzidas em conformidade com as mais rigorosas normas de qualidade, as peças Padrão e Klin garantem segurança para você e sua família.

Características da Linha Klin

- ✓ Funcional para qualquer estilo
- ✓ Superfície lisa de alto brilho que facilita a limpeza da peça
- ✓ Acabamento com parafusos aparentes
- ✓ Placas, tomadas e interruptores com corpo e mecanismo brancos

Características da Linha Padrão

- ✓ Design atemporal com cantos arredondados
- ✓ Superfície levemente texturizada de toque agradável
- ✓ Acabamento com parafusos aparentes
- ✓ Padrão de mercado: placa cinza, tomadas e interruptores com corpo preto e mecanismo amarelo
- ✓ Placas e mecanismos fornecidos separadamente



Klin

Placas

Placa 4x2"

	Descrição	Embalagem (pçs)	Código
	Placa 4x2" cega	50	13327761
	Placa 4x2" para 1 interruptor	50	13327763
	Placa 4x2" para 2 interruptores ou 1 tomada 2P+T 10 A - 250 V~	50	13327766
	Placa 4x2" para 3 interruptores ou 2 tomadas 2P+T 10 A - 250 V~	50	13327776
	Placa 4x2" para tomada elétrica redonda e tomada de telefone	50	13327768
	Placa 4x2" com saída de fio para TV	50	13327771
	Placa cega redonda 4"	40	13327793
	Mix placa 4x2" cega e placa 4x2" com saída de fio para TV	50	13327774

Klin

Placas

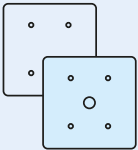

Placa 4x4"

	Descrição	Embalagem (pçs)	Código
	Placa 4x4" cega	40	13327788
	Placa 4x4" para 2 interruptores + 2 interruptores ou 1 tomada 2P+T +1 tomada 2P+T	40	13327790
	Placa 4x4" para 5 interruptores ou 1 tomada 2P+T + 2 tomadas 2P+T	40	13327811
	Placa 4x4" para 6 interruptores ou 2 tomada 2P+T + 2 tomadas 2P+T	40	13327797
	Placa 4x4" para tomada elétrica redonda e tomada de telefone	40	13327794
	Placa 4x4" com saída de fio para TV	40	13327809
	Mix placa 4x4" cega e placa 4x4" com saída de fio para TV	40	13327813



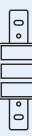
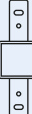

Klin

Itens sem placa

Interruptores

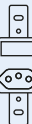
	Descrição	Embalagem (pçs)	Código
	1 interruptor simples 10 A - 250 V~	40	13327814
	1 interruptor paralelo 10 A - 250 V~	40	12840587
	2 interruptores simples 10 A - 250 V~	25	13328225
	2 interruptores paralelos 10 A - 250 V~	25	13328301
	1 interruptor simples + 1 interruptor paralelo 10 A - 250 V~	25	13328217
	3 interruptores simples 10 A - 250 V~	25	13328425
	3 interruptores paralelos 10 A - 250 V~	25	13328424
	2 interruptores simples + 1 interruptor paralelo 10 A - 250 V~	25	13328431
	2 interruptores paralelos + 1 interruptor simples 10 A - 250 V~	25	13328468
	1 interruptor bipolar (simples/paralelo) 10 A - 250 V~	25	13328474

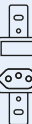



Interruptores com tomadas

	Descrição	Embalagem (pçs)	Código
	1 interruptor simples + 1 tomada 2P+T 10 A - 250 V~	25	13328729
	1 interruptor paralelo + 1 tomada 2P+T 10 A - 250 V~	25	13328731
	2 interruptores simples + 1 tomada 2P+T 10 A - 250 V~	25	13328735
	2 interruptores paralelos + 1 tomada 2P+T 10 A - 250 V~	25	13328752
	1 interruptor simples + 1 interruptor paralelo + 1 tomada 2P+T 10 A - 250 V~	25	13328750
	1 interruptor simples + 1 tomada 2P+T 20 A - 250 V~	25	13328753
	1 interruptor paralelo + 1 tomada 2P+T 20 A - 250 V~	25	13328762
	2 interruptores simples + 1 tomada 2P+T 20 A - 250 V~	25	13328768
	2 interruptores paralelos + 1 tomada 2P+T 20 A - 250 V~	25	13328777
	1 interruptor simples + 1 interruptor paralelo + 1 tomada 2P+T 20 A - 250 V~	25	13328765

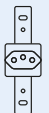

Klin

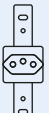
Itens sem placa

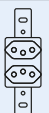
Tomadas de energia

	Descrição	Embalagem (pçs)	Código
	1 tomada 2P+T 10 A - 250 V~	25	13329377
	1 tomada 2P+T 10 A - 250 V~ corpo branco com fundo vermelho	25	13329540
	1 tomada redonda 2P+T 10 A - 250 V toda branca	25	14017920
	2 tomadas 2P+T 10 A - 250 V~	25	13329645
	1 tomada 2P+T 20 A - 250 V~	25	13330048
	1 tomada 2P+T 20 A - 250 V~ corpo branco com fundo vermelho	25	13330050
	1 tomada redonda 2P+T 20 A - 250 V toda branca	25	14017939
	2 tomadas 2P+T 20 A - 250 V~	25	13330083

Pulsadores

	Descrição	Embalagem (pçs)	Código
	1 pulsador para campainha 10 A - 250 V~	40	13330117
	1 pulsador para minuteria 10 A - 250 V~	40	13330141

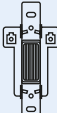

Eletrônicos, campainhas

	Descrição	Embalagem (pçs)	Código
	1 cigarra bivolt (127 V ca / 220 V ca)	25	13330203



Klin

Conjuntos montados 4x2"

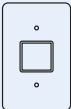
Interruptores

	Descrição	Embalagem (pçs)	Código
	1 interruptor simples 10 A - 250 V~ com placa 4x2"	20	13328220
	1 interruptor paralelo 10 A - 250 V~ com placa 4x2"	20	13328223
	2 interruptores simples 10 A - 250 V~ com placa 4x2"	15	13328419
	2 interruptores paralelos 10 A - 250 V~ com placa 4x2"	15	13328488
	1 interruptor simples + 1 interruptor paralelo 10 A - 250 V~ com placa 4x2"	15	13328421
	3 interruptores simples 10 A - 250 V~ com placa 4x2"	15	13328434
	3 interruptores paralelos 10 A - 250 V~ com placa 4x2"	15	13328432
	2 interruptores simples + 1 interruptor paralelo 10 A - 250 V~ com placa 4x2"	15	13328469
	2 interruptores paralelos + 1 interruptor simples 10 A - 250 V~ com placa 4x2"	15	13328470
	1 interruptor bipolar (simples/paralelo) 10 A - 250 V~ com placa 4x2"	15	13328475

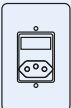
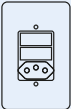
Interruptores com tomadas

	Descrição	Embalagem (pçs)	Código
	1 interruptor simples + 1 tomada 2P+T 10 A - 250 V~ com placa 4x2"	15	13328734
	1 interruptor paralelo + 1 tomada 2P+T 10 A - 250 V~ com placa 4x2"	15	13328730
	2 interruptores simples + 1 tomada 2P+T 10 A - 250 V~ com placa 4x2"	15	13328749
	2 interruptores paralelos + 1 tomada 2P+T 10 A - 250 V~ com placa 4x2"	15	13328754
	1 interruptor simples + 1 interruptor paralelo + 1 tomada 2P+T 10 A - 250 V~ com placa 4x2"	15	13328751
	1 interruptor simples + 1 tomada 2P+T 20 A - 250 V~ com placa 4x2"	15	13328759
	1 interruptor paralelo + 1 tomada 2P+T 20 A - 250V~ com placa 4x2"	15	13328767
	2 interruptores simples + 1 tomada 2P +T 20 A - 250 V~ com placa 4x2"	15	13328776
	2 interruptores paralelos + 1 tomada 2P +T 20 A - 250 V~ com placa 4x2"	15	13328773
	1 interruptor simples + 1 interruptor paralelo + 1 tomada 2P +T 20 A - 250 V~ com placa 4x2"	15	13328782

Klin

Conjuntos montados 4x2"

Tomadas de energia

	Descrição	Embalagem (pçs)	Código
	1 tomada 2P+T 10 A - 250 V~ com placa 4x2"	15	13329640
	1 tomada 2P+T 10 A - 250 V~ corpo branco com fundo vermelho com placa 4x2"	15	13329643
	2 tomadas 2P+T 10 A - 250 V~ com placa 4x2"	15	13329886
	1 tomada 2P+T 20 A - 250 V~ com placa 4x2"	15	13330057
	1 tomada 2P+T 20 A - 250 V~ corpo branco com fundo vermelho com placa 4x2"	15	13330081
	2 tomadas 2P+T 20 A - 250 V~ com placa 4x2"	15	13330111

Pulsadores

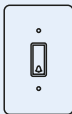
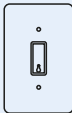
	Descrição	Embalagem (pçs)	Código
	1 pulsador para campainha 10 A - 250 V~ com placa 4x2"	20	13330139
	1 pulsador para minuteria 10 A - 250 V~ com placa 4x2"	20	13330143

Tomada de comunicação com suporte plástico embutido

	Descrição	Embalagem (pçs)	Código
	Placa 4x2" com 1 furo com colar para RJ45	40	13331460
	Placa 4x2" com 1 keystone RJ45 - CAT 5E	15	13331464
	1 tomada 2 RJ11 frontal 2 fios com placa 4x2"	15	13330900

Klin

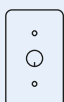

Conjuntos montados 4x2"

Eletrônicos, campainhas

	Descrição	Embalagem (pçs)	Código
	1 cigarra bivolt (127 V ca / 220 V ca) com placa 4x2"	15	13330394
	Variador de luminosidade rotativo 127 V ca/300 W com placa 4x2" (uso em lâmpadas incandescentes, halógenas, dicróicas e fluorescentes dimerizável)	1	13330430
	Variador de luminosidade rotativo 220 V ca/600 W com placa 4x2" (uso em lâmpadas incandescentes, halógenas, dicróicas e fluorescentes dimerizável)	1	13330432

Conjuntos montados 4x4"

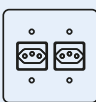
Tomadas de energia

	Descrição	Embalagem (pçs)	Código
	2 tomadas 2P+T 10 A - 250 V~ com placa 4x4"	10	13330435
	2 tomadas 2P+T 20 A - 250 V~ com placa 4x4"	10	13330490

Tomadas de comunicação com suporte embutido

	Descrição	Embalagem (pçs)	Código
	Placa 4x4" com 1 furo + com colar para RJ45	30	13331629
	Placa 4x4" com 1 keystone RJ45 - CAT 5E	10	13331632

Padrão

Placas

Placa 4x2"

	Descrição	Embalagem (pçs)	Código
	Placa 4x2" cega	50	13327764
	Placa 4x2" para 1 interruptor	50	13327762
	Placa 4x2" para 2 interruptores ou 1 tomada 2P+T 10 A - 250 V~	50	13327816
	Placa 4x2" para 3 interruptores ou 2 tomadas 2P+T 10 A - 250 V~	50	13327795
	Placa 4x2" para tomada elétrica redonda e tomada de telefone	50	13327765
	Placa 4x2" com saída de fio para TV	50	13327767
	Placa cega redonda 4"	40	13327796
	Mix placa 4x2" cega e placa 4x2" com saída de fio para TV	50	13327777

Padrão

Placas



Placa 4x4"

	Descrição	Embalagem (pçs)	Código
	Placa 4x4" cega	40	13327775
	Placa 4x4" para 2 interruptores + 2 interruptores ou 1 tomada 2P+T +1 tomada 2P+T	40	13327789
	Placa 4x4" para tomada elétrica redonda e tomada de telefone	40	13327808
	Placa 4x4" com saída de fio para TV	40	13327815
	Mix placa 4x4" cega e placa 4x4" com saída de fio para TV	40	13327810

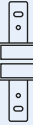

Padrão

Itens sem placa

Interruptores

	Descrição	Embalagem (pçs)	Código
	1 interruptor simples 10 A - 250 V~	40	13327812
	1 interruptor paralelo 10 A - 250 V~	40	12355488
	2 interruptores simples 10 A - 250 V~	25	13328224
	2 interruptores paralelos 10 A - 250 V~	25	13328226
	1 interruptor simples + 1 interruptor paralelo 10 A - 250 V~	25	13328302
	3 interruptores simples 10 A - 250 V~	25	13328422
	3 interruptores paralelos 10 A - 250 V~	25	13328426
	2 interruptores simples + 1 interruptor paralelo 10 A - 250 V~	25	13328427
	2 interruptores paralelos + 1 interruptor simples 10 A - 250 V~	25	13328428
	1 interruptor bipolar (simples/paralelo) 10 A - 250 V~	25	13328473
	1 interruptor intermediário 10 A - 250 V~	25	13328477



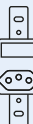
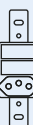

Interruptores com tomadas

	Descrição	Embalagem (pçs)	Código
	1 interruptor simples + 1 tomada 2P+T 10 A - 250 V~	25	13328728
	1 interruptor paralelo + 1 tomada 2P+T 10 A - 250 V~	25	13328733
	2 interruptores simples + 1 tomada 2P+T 10 A - 250 V~	25	13328737
	2 interruptores paralelos + 1 tomada 2P+T 10 A - 250 V~	25	13328761
	1 interruptor simples + 1 interruptor paralelo + 1 tomada 2P+T 10 A - 250 V~	25	13328748
	1 interruptor simples + 1 tomada 2P+T 20 A - 250 V~	25	13328758
	1 interruptor paralelo + 1 tomada 2P+T 20 A - 250 V~	25	13328755
	2 interruptores simples + 1 tomada 2P+T 20 A - 250 V~	25	13328766
	2 interruptores paralelos + 1 tomada 2P+T 20 A - 250 V~	25	13328770
	1 interruptor simples + 1 interruptor paralelo + 1 tomada 2P+T 20 A - 250 V~	25	13328764

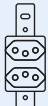

Padrão

Itens sem placa

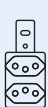
Tomadas de energia

	Descrição	Embalagem (pçs)	Código
	1 tomada 2P+T 10 A - 250 V~	25	13329376
	1 tomada 2P+T 10 A - 250 V~ corpo preto com fundo preto	25	13329538
	1 tomada 2P+T 10 A - 250 V~ corpo preto com fundo vermelho	25	13329539
	1 tomada 2P+T 10 A - 250 V~ corpo vermelho com fundo vermelho	25	13329541
	1 tomada redonda 2P+T 10 A - 250 V corpo preto com fundo amarelo	25	14017886
	1 tomada redonda 2P+T 10 A - 250 V toda preta	25	14173997
	1 tomada redonda 2P+T 10 A - 250 V toda vermelha	25	14017924
	2 tomadas 2P+T 10 A - 250 V~	25	12756785
	2 tomadas 2P+T 10 A - 250 V~ corpo preto com fundo pretos	25	13329646
	2 tomadas 2P+T 10 A - 250 V~ corpo preto, 1 fundo preto e 1 fundo marfim	25	13329946
	2 tomadas 2P+T 10 A - 250 V~ corpo preto, 1 fundo preto e 1 fundo vermelho	25	13329947
	2 tomadas 2P+T 10 A - 250 V~ corpo preto com fundo vermelho	25	13329884
	1 tomada 2P+T 20 A - 250 V~	25	13329887
	1 tomada 2P+T 20 A - 250 V~ corpo preto com fundo preto	25	12057099
	1 tomada 2P+T 20 A - 250 V~ corpo preto com fundo vermelho	25	13330049
	1 tomada 2P+T 20 A - 250 V~ corpo vermelho com fundo vermelho	25	13330055
	1 tomada redonda 2P+T 20 A - 250 V corpo preto com fundo amarelo	25	14017938
	1 tomada redonda 2P+T 20 A - 250 V toda preta	25	14174518
	1 tomada redonda 2P+T 20 A - 250 V toda vermelha	25	14017941
	2 tomadas 2P+T 20 A - 250 V~	25	13330082
	2 tomadas 2P+T 20 A - 250 V~ corpo preto com fundo preto	25	13330084
	2 tomadas 2P+T 20 A - 250 V~ corpo preto, 1 fundo preto e 1 fundo marfim	25	13330085
	2 tomadas 2P+T 20 A - 250 V corpo preto com fundo marfim	25	14239821
	2 tomadas 2P+T 20 A - 250 V~ corpo preto, 1 fundo preto e 1 fundo vermelho	25	13330086
	2 tomadas 2P+T 20 A - 250 V~ corpo preto com fundo vermelho	25	13330087

Pulsadores

	Descrição	Embalagem (pçs)	Código
	1 pulsador para campainha 10 A - 250 V~	40	13330114
	1 pulsador para minuteria 10 A - 250 V~	40	13330140

Eletrônicos, campainhas

	Descrição	Embalagem (pçs)	Código
	1 cigarra bivolt (127 V ca / 220 V ca)	25	13330198

Dimensões (mm)

Klin

Placa 4x2 - 1 int.

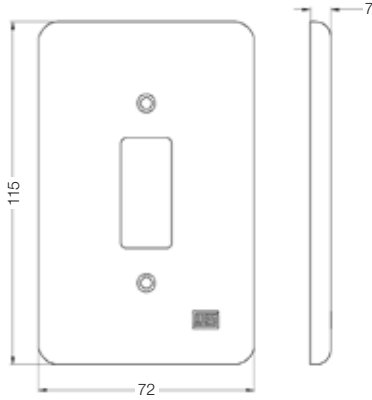

Placa 4x2 - 2 int.

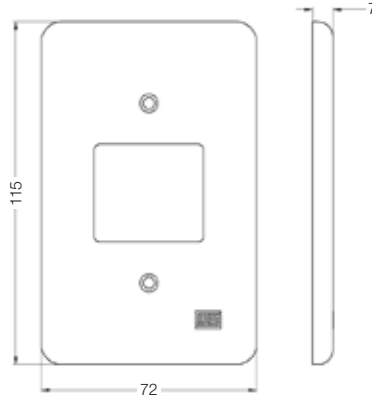

Placa 4x2 - 3 int.

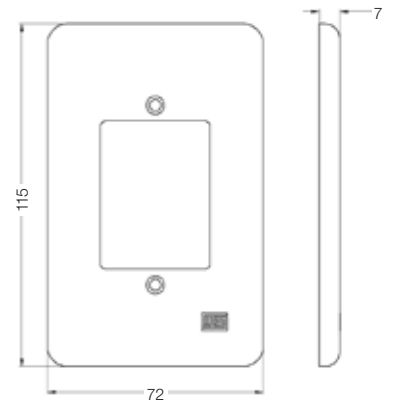

Placa 4x2 - antena

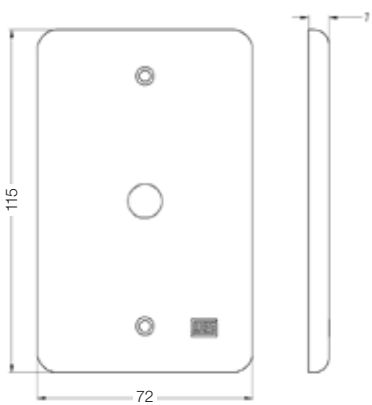

Placa 4x2 - telefone

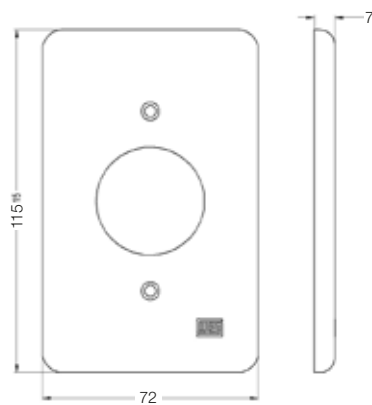

Placa 4x2 - cega

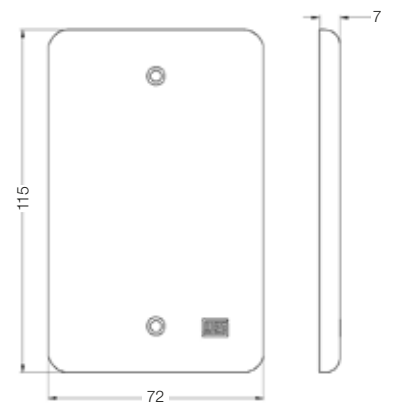

Placa 4x4 - 4 int.

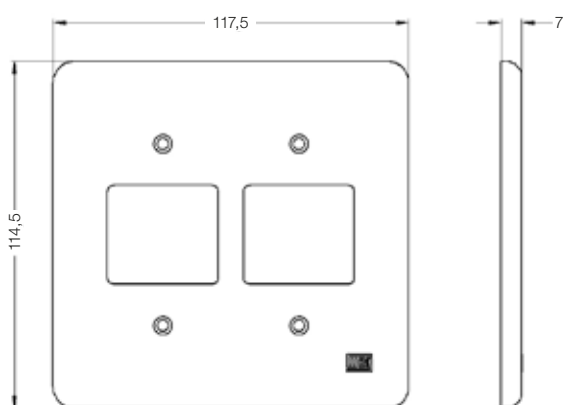

Placa 4x4 - 2 int. - 3 int.

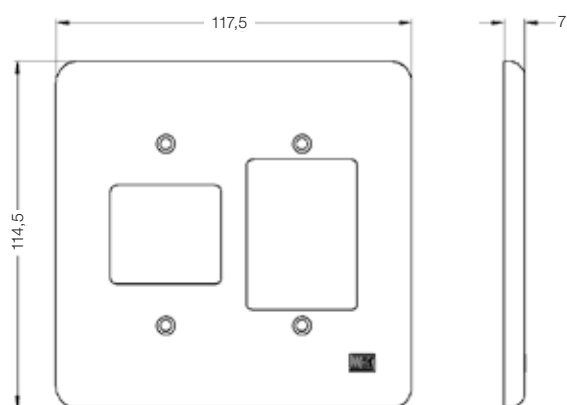

Dimensões (mm)

Klin

Placa 4x4 - 6 int.

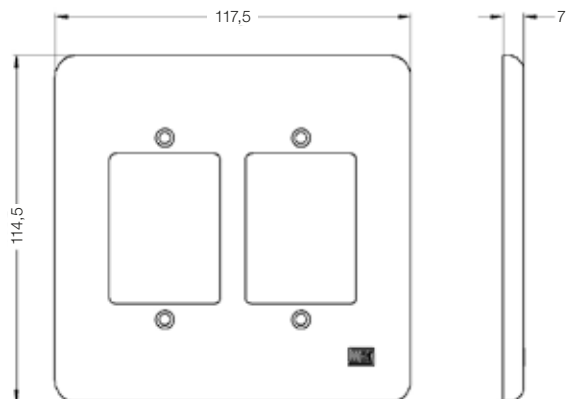

Placa 4x4 - antena

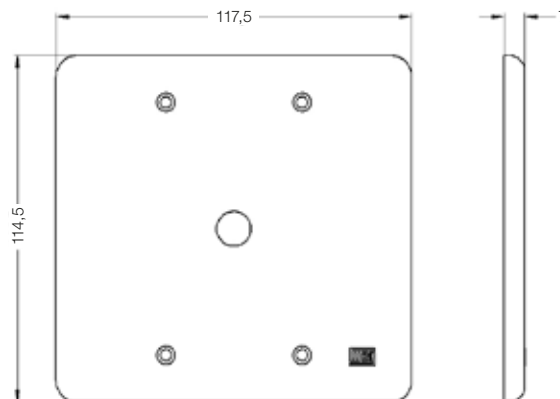

Placa 4x4 - cega

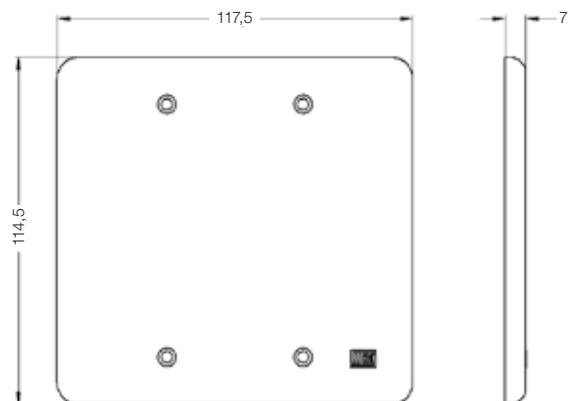

Placa 4x4 - 2 telefones

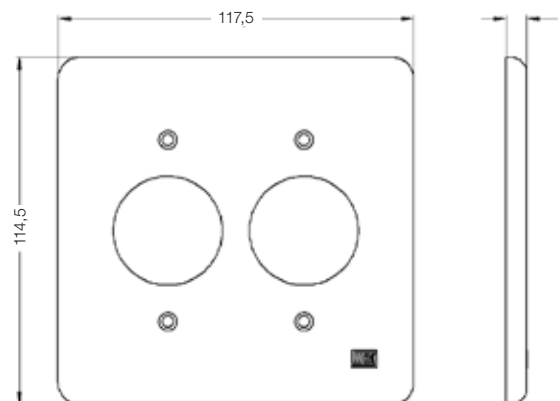

Padrão

Placa 4x2 - 1 int.

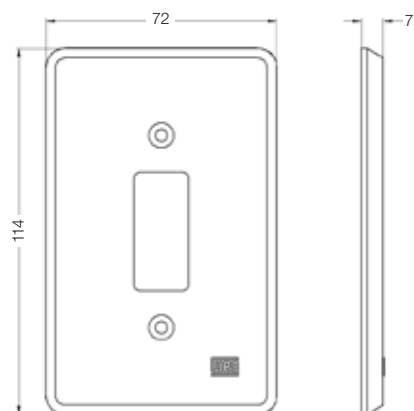

Placa 4x2 - 2 int.

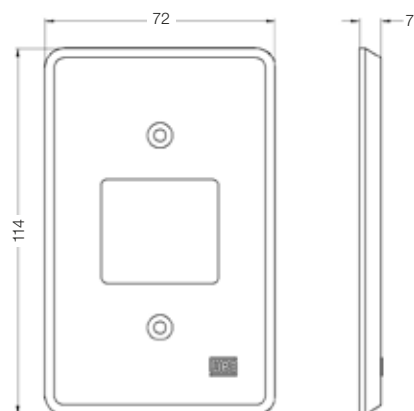

Placa 4x2 - 3 int.

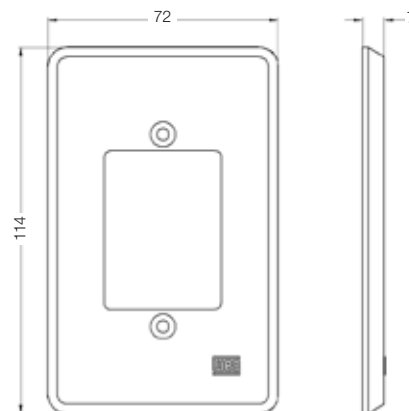

Dimensões (mm)

Padrão

Placa 4x2 - antena

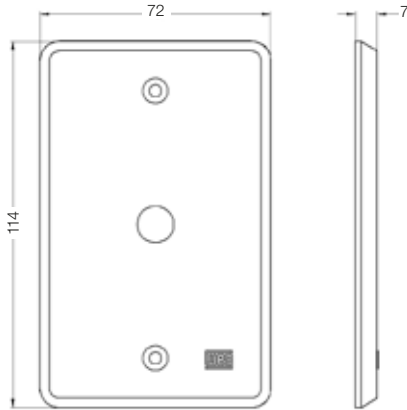

Placa 4x2 - cega

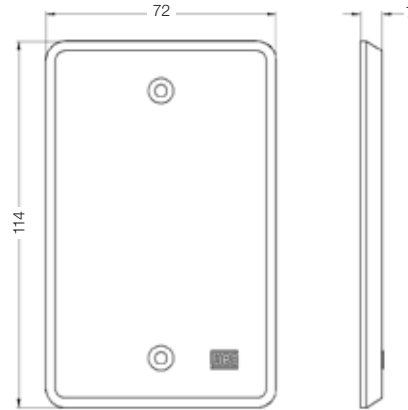

Placa 4x2 - telefone

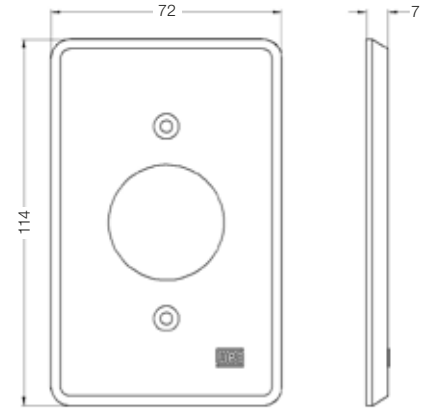

Placa 4x4 - 4 int.

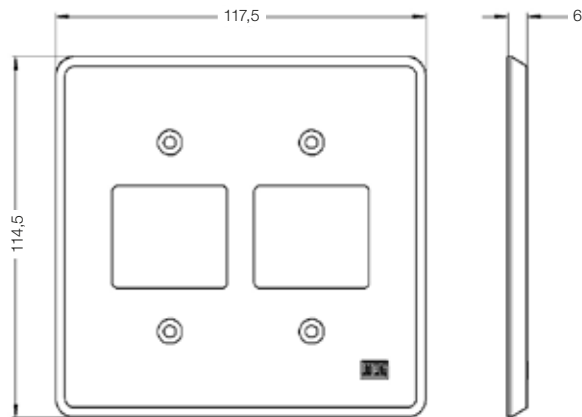

Placa 4x4 - 2 telefones

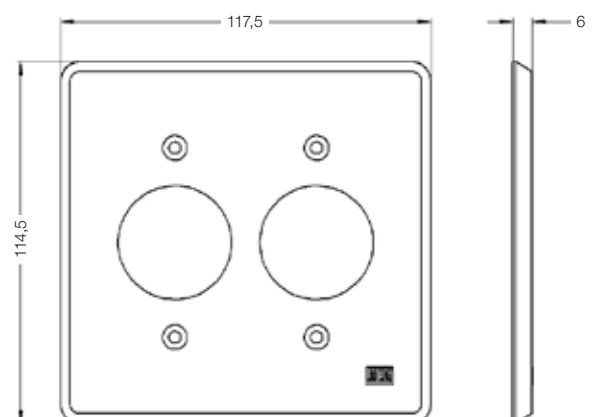

Placa 4x4 - antena

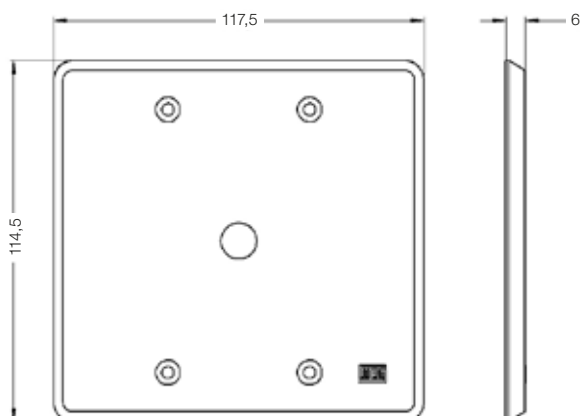

Placa 4x4 - cega

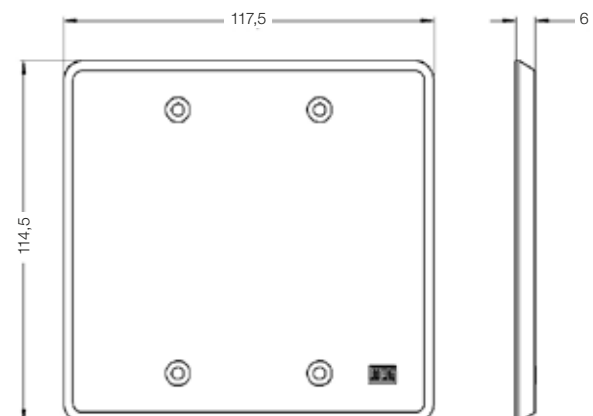

Dimensões (mm)

Mecanismos

Tomada redonda 10 A - aba longa

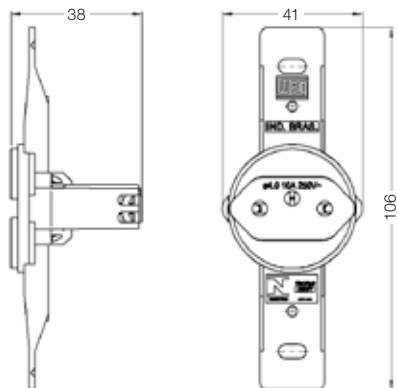

Tomada redonda 20 A - aba longa

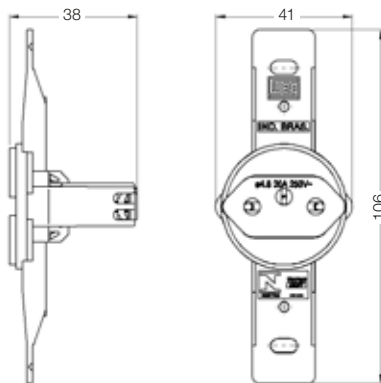

2 interruptor + 1 tomada 2P+T - 10 A

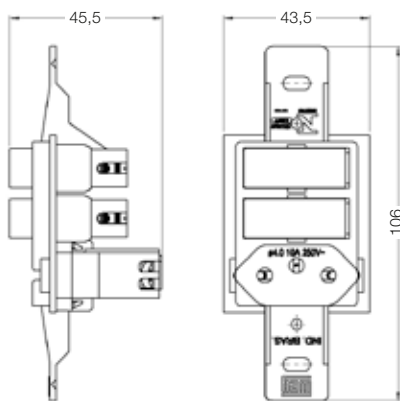

2 interruptor + 1 tomada 2P+T - 20 A

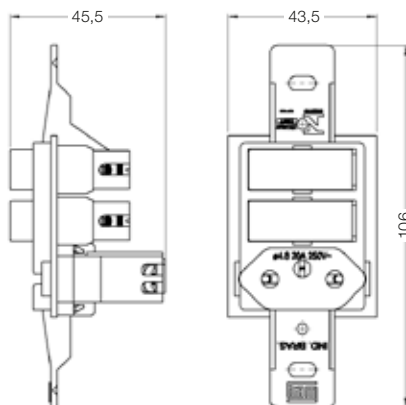

2 tomadas 2P+T 10 A

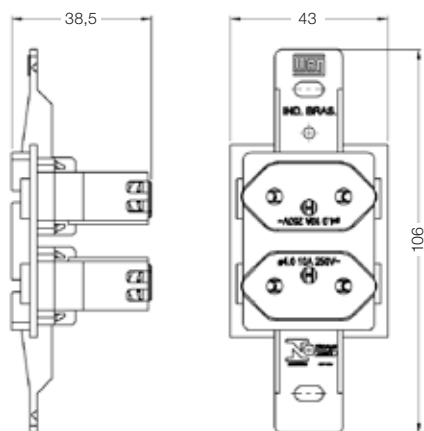

2 tomadas 2P+T 20 A

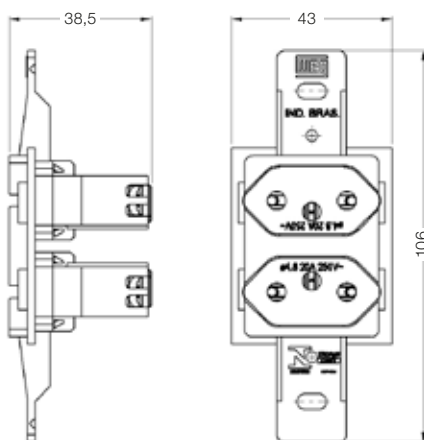

Dimensões (mm)

Mecanismos

1 interruptor

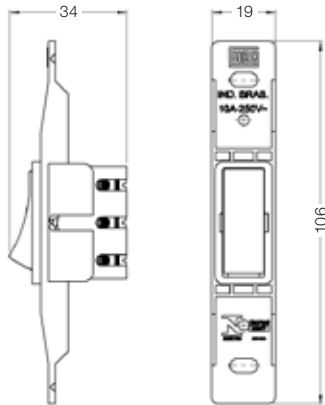

2 interruptores

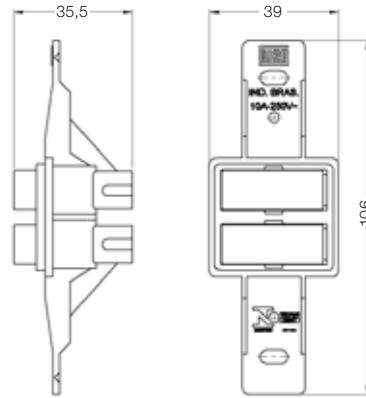

1 interruptor + 1 tomada 2P+T - 10 A

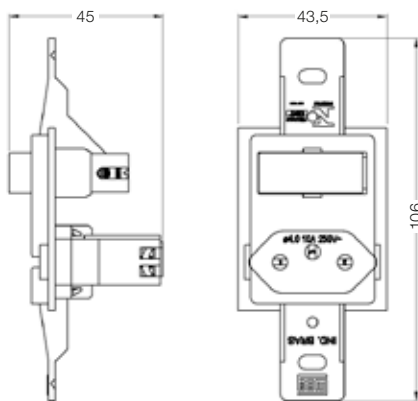

1 interruptor + 1 tomada 2P+T - 20 A

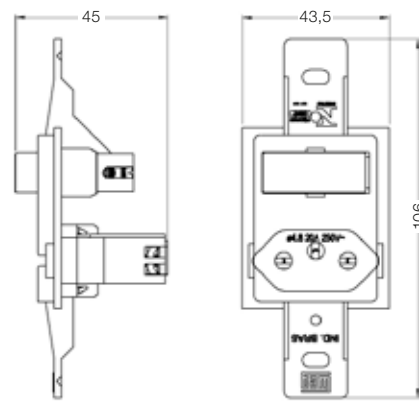

3 interruptores

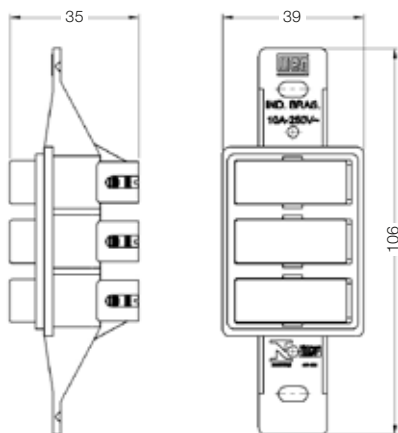

1 tomada 2P+T 10 A

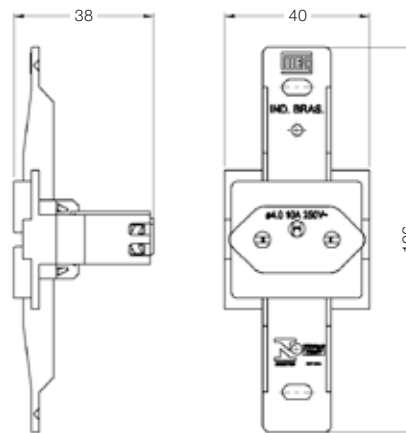

Dimensões (mm)

Mecanismos

1 tomada 2P+T 20 A

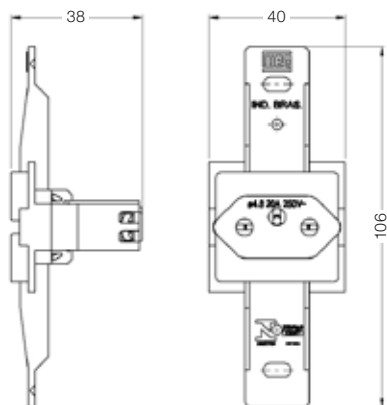

1 interruptor bipolar

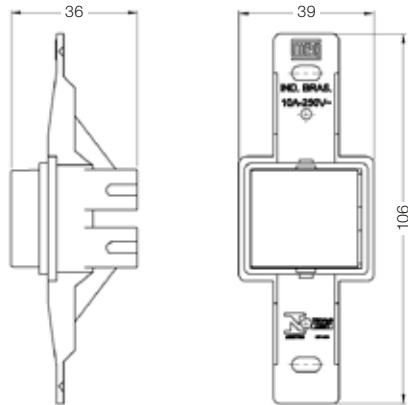

Presença Global é essencial. Entender o que você precisa também.

Presença Global

Com mais de 30.000 colaboradores por todo o mundo, somos um dos maiores produtores mundiais de motores elétricos, equipamentos e sistemas eletroeletrônicos. Estamos constantemente expandindo nosso portfólio de produtos e serviços com conhecimento especializado e de mercado. Criamos soluções integradas e customizadas que abrangem desde produtos inovadores até assistência pós-venda completa.

Com o *know-how* da WEG, as **Tomadas & Interruptores - Linhas Klin e Padrão** são a escolha certa para sua aplicação e seu negócio, com segurança, eficiência e confiabilidade.



Disponibilidade é possuir uma rede global de serviços



Parceria é criar soluções que atendam suas necessidades



Competitividade é unir tecnologia e inovação

Conheça

Produtos de alto desempenho e confiabilidade, para melhorar o seu processo produtivo.

Excelência é desenvolver soluções que aumentem a produtividade de nossos clientes, com uma linha completa para automação industrial.

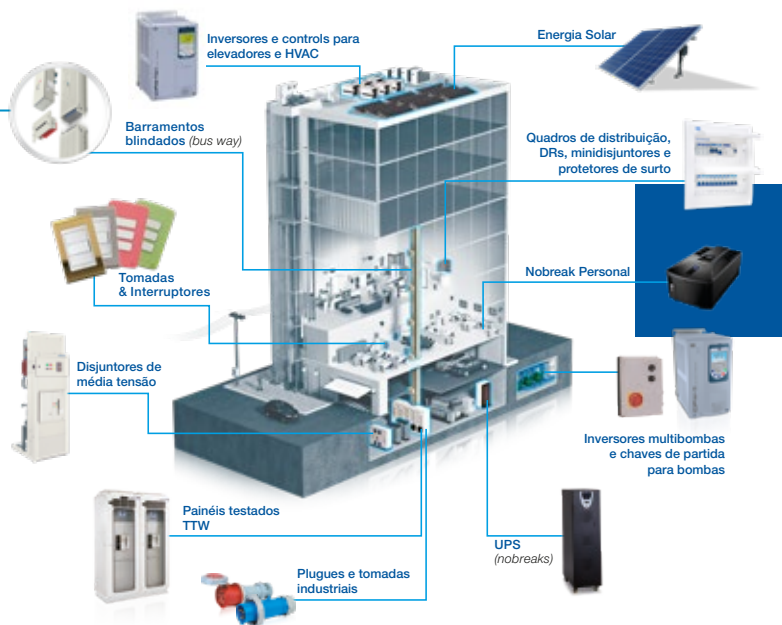

Acesse:

www.weg.net



youtube.com/wegvideos

O escopo de soluções do Grupo WEG não se limita aos produtos e soluções apresentados nesse catálogo.

Para conhecer nosso portfólio, consulte-nos.

Conheça as operações mundiais da WEG



www.weg.net



 +55 47 3276.4000

 automacao@weg.net

 Jaraguá do Sul - SC - Brasil