

Frequency Inverter

CFW900

User's Manual

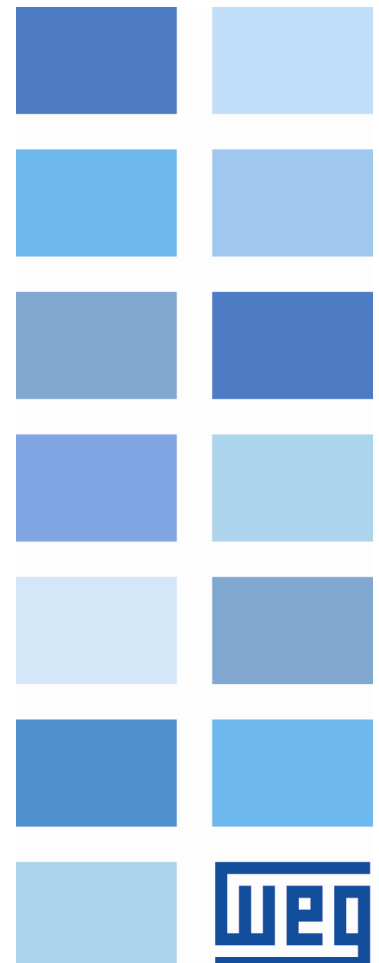



User's Manual

Series: CFW900

Language: English

Document: 10008985516 / 01

Models: Frame Sizes A, B, C, D and E

Publication Date:04/2022

SUMMARY OF REVISIONS

The information below describes the revisions made to this manual.

Version	Revision	Description
-	R00	First edition.
-	R01	Update of tables, figures and identification labels and general corrections.

1	SAFETY INSTRUCTIONS	1
1.1	SAFETY WARNINGS IN THIS MANUAL	1
1.2	SAFETY WARNINGS IN THE PRODUCT	1
1.3	PRELIMINARY RECOMMENDATIONS	1
2	GENERAL INFORMATION	3
2.1	ABOUT THE MANUAL	3
2.2	TERMS AND DEFINITIONS	3
2.3	ABOUT THE CFW900	5
2.3.1	Identification Labels	8
2.3.2	Receiving and Storage	9
3	INSTALLATION AND CONNECTION	11
3.1	MECHANICAL INSTALLATION	11
3.1.1	Environmental Conditions	11
3.1.2	Positioning and Mounting	11
3.1.3	Horizontal Mounting	13
3.1.4	Cabinet Mounting	14
3.1.4.1	Surface Mounting	14
3.1.4.2	Flange Mounting	14
3.1.5	Access to Control and Power Terminals	15
3.1.6	HMI Installation at the Cabinet Door or Command Panel (Remote HMI)	17
3.2	ELECTRICAL INSTALLATION	17
3.2.1	Identification of the Power and Grounding Terminals	18
3.2.2	Power and Grounding Wiring	20
3.2.3	Fuses, Circuit Breakers and Power Supply Capacity	25
3.2.3.1	Pre-charge Circuit Control Fuses	29
3.2.4	Power Connections	29
3.2.4.1	IT and Delta Corner Earthed Networks	30
3.2.4.2	Dynamic Braking	31
3.2.4.2.1	Sizing the Braking Resistor	32
3.2.4.2.2	Installation of the Braking Resistor	33
3.2.4.3	Output Connections	34
3.2.4.3.1	Motor cables	35
3.2.4.3.2	Connection of the Motor Cable Shield to Ground	36
3.2.5	Grounding Connections	37
3.2.6	Control Connections	38
3.2.6.1	Internal 24 Vdc Power Supply Current Capacity	42
3.2.6.2	Use of a 24 Vdc External Power Supply	43
3.3	INSTALLATION ACCORDING TO THE EUROPEAN DIRECTIVE OF ELECTROMAGNETIC COMPATIBILITY	45
3.3.1	Standard Definitions	45
3.3.2	Conformal Installation	46
3.3.3	Emission and Immunity Levels Met	46
4	HMI	47
4.1	MAIN SCREEN	48

4.2	MENU ACCESS MODE - MENU LEVELS	49
4.2.1	Reading Variables - Status and Diagnostics Menus	49
4.2.2	Writing Variables - Configurations Menu	50
4.2.3	Writing Variables - Wizards Menu	50
4.3	HELP KEY	50
4.4	DATE AND TIME SETTING	51
4.5	MAIN SCREEN SETTING	51
4.5.1	View Modes	51
4.5.2	Modification of the Main Screen	52
4.5.3	Screen Examples	54
4.6	USB MODE	54
4.7	INSTALLING THE HMI	55
5	FIRST TIME POWER-UP AND START-UP	56
5.1	PREPARE FOR START-UP	56
5.2	START-UP	56
5.3	INSTRUCTIONS FOR COMPUTER CONNECTION	57
6	TROUBLESHOOTING AND MAINTENANCE	58
6.1	OPERATION OF PROTECTIONS, FAULTS AND ALARMS	58
6.2	PROTECTIONS, FAULTS, ALARMS, AND POSSIBLE CAUSES	59
6.3	PROTECTION, FAULT AND ALARM TABLE	59
6.4	SOLUTIONS FOR THE MOST FREQUENT PROBLEMS	89
6.5	INFORMATION FOR CONTACTING TECHNICAL SUPPORT	89
6.6	PREVENTIVE MAINTENANCE	90
6.7	CLEANING INSTRUCTIONS	91
7	ACCESSORIES	92
7.1	LIST OF ACCESSORIES	92
7.2	BACKPLANE REPLACEMENT	93
7.3	INSTALLING THE CONTROL ACCESSORY	93
8	TECHNICAL SPECIFICATIONS	95
8.1	INVERTER POWER DATA	95
8.1.1	Input	95
8.1.2	Output	96
8.1.3	General Data	96
8.1.4	Environmental and Mechanical Data	97
8.1.5	Current, Motor and Loss Data	98
8.2	DEFINITIONS OF DERATING FACTORS	101
8.2.1	Introduction	101
8.2.2	Derating factor according to the Ambient Temperature (FD _{ta})	102
8.2.3	Derating factor according to the Switching Frequency (FD _{sw})	103
8.2.4	Derating factor according to the Altitude of the Installation Site	104
8.2.5	Other Derating Factors	105
8.3	INVERTER CONTROL DATA	106

8.3.1	General Control Specifications	106
8.3.2	Input and Output Specifications	107
8.3.3	Specifications of the Communication Networks	108
8.3.4	Standards and Certifications	108
8.4	MECHANICAL DATA	109
8.4.1	Frame Size A	109
8.4.2	Frame Size B	110
8.4.3	Frame Size C	111
8.4.4	Frame Size D	112
8.4.5	Frame Size E	113
8.4.6	Frames A, B and C with IP21 kit	114
8.4.7	Frames D and E with IP21 kit	115
8.4.8	Frames A, B and C with UL Type 1 kit	116
8.4.9	Frames D and E with UL type 1 kit	117

1 SAFETY INSTRUCTIONS

This manual provides information for the proper installation and operation of the CFW900 frequency inverter. Only trained and qualified personnel should attempt to install, start-up and troubleshoot this type of equipment.

1.1 SAFETY WARNINGS IN THIS MANUAL

The following safety warnings are used in this manual:

**DANGER!**

Failure to follow the recommended procedures listed in this warning may result in death, serious injury and equipment damage.

**WARNING!**

Failure to follow the recommended procedures listed in this warning may result in equipment damage.

**NOTE!**

This warning provides important information for the proper understanding and operation of the equipment.

1.2 SAFETY WARNINGS IN THE PRODUCT

The following symbols are attached to the product, serving as safety notices:



High voltages are present.



Components sensitive to electrostatic discharge. Do not touch them.



Mandatory connection to the protective earth (PE).



Connection of the shield to the ground.



Hot surface.

1.3 PRELIMINARY RECOMMENDATIONS

**NOTE!**

Fully read the manual before installing or operating the inverter.

**DANGER!**

Only duly qualified personnel should plan or perform the installation, start-up, operation and maintenance of the CFW900 and its accessories. To that end, all safety instructions contained in the manual must be followed, together with those defined by local regulations. Failure to comply with the safety instructions may lead to material damage or risk of death.

**NOTE!**

For the purpose of this manual, qualified personnel are those trained and able to:

- Install, power up and operate the CFW900 in accordance with this manual and the safety legal procedures in force;
- Provide first aid;
- Use the protective equipment according to the regulations in force.

**DANGER!**

After disconnecting the general power to the inverter, wait at least ten minutes before touching any internal part, as some components can store electrical energy or remain in mechanical inertia even after the shutdown.

In addition, always connect the grounding point of the inverter to the protection earth (PE).

**NOTE!**

Frequency inverters may cause interference in other electronic devices. Follow the recommendations listed in [Chapter 3](#) to minimize these effects.

**Do not perform a withstand voltage test (hipot test) on any part of the inverter!
If it is necessary consult WEG.**

**WARNING!**

The electronic boards in this product contain components sensitive to electrostatic discharges. Do not touch the components or connectors directly.

**DANGER!****Crushing Hazard**

In load hoisting applications, it is necessary to install auxiliary safety devices (electrical, mechanical or both) in order to avoid accidents.

**DANGER!**

This product was not designed to be used as a safety element. Therefore, additional measures must be taken so as to avoid material damages and personal injuries.

The product was manufactured under strict quality control, however, if installed in systems where its failure causes risks of material or personal damages, additional external safety devices must ensure a safety condition in case of a product failure, preventing accidents.

2 GENERAL INFORMATION

2.1 ABOUT THE MANUAL

This manual contains information for the proper installation and operation of the inverter, as well as start-up procedures, main technical features and how to identify the most usual problems of the different models of inverters of the line CFW900.

**WARNING!**

The operation of this device requires detailed installation and operation instructions, which are provided in the quick installation guide, user manual, programming manual and communication manuals. The guides are supplied printed together with their respective accessory, or you can download them on WEG website - www.weg.net. A printed copy of the files available on WEG's website can be requested at your local WEG dealer.

**NOTE!**

It is not the intention of this manual to present all the possibilities for the application of the CFW900, as well as WEG cannot take any liability for the use of the CFW900 which is not based on this manual.

For more information about other functions, accessories and communication, refer to the following manuals:

- CFW900 Programming Manual;
- CFW900 - ENC encoder accessory;
- Analog input and output accessories - CFW900-IOAI;
- Digital inputs and outputs accessories - CFW900-IOD;
- Relay accessories - CFW900-REL;
- Temperature measurement accessory - CFW900-TEMP;
- Communication accessory - CFW900-CCAN;

2.2 TERMS AND DEFINITIONS

°C: Celsius degree.

°F: Fahrenheit degree.

A: Ampères.

DC Link: inverter intermediate circuit that contains the DC voltage obtained by the rectification of the AC power supply line or by an external source. It supplies the output inverter bridge with IGBTs.

U, V, W Arms: set of two IGBTs of the inverter output phases U, V, and W.

AC: alternated current.

DC: direct current.

CFM: Cubic Feet per Minute; unit of flow.

Pre-charge Circuit: charges the DC link capacitors with limited current, preventing damages to the equipment at power-up.

PLC: Programmable Logic Controller.

cm: centimeter.

CV: Cavalo-Vapor (Brazilian unit of measurement of power), corresponding to 736 watts.

Heatsink: metal device designed to dissipate the heat generated by the power semiconductors.

RFI filter: Radio Frequency Interference Filter, is a filter used to reduce interference in the radio frequency range.

Switching frequency: frequency of the IGBTs switching in the inverter bridge.

ft: foot. Is a unit of measure of length.

Gate driver: circuit used to turn the IGBTs on and off in a controlled and safe way.

Start/Stop: function of the inverter that, when enabled (Run), accelerates the motor by acceleration ramp up to the reference speed and, when disabled (Stop), decelerates the motor by deceleration ramp until full stop, when the PWM pulses are then locked.

General Enable: when activated, this function accelerates the motor via acceleration ramp set in the inverter. When deactivated, this function immediately blocks the PWM pulses. It can be controlled by digital input or via serial communication.

HMI: Human Machine Interface; device that allows controlling the inverter parameters.

hp: Horse Power, corresponds to 746 watts.

Hz: hertz.

I_{nom-HD}: inverter rated current for use with the heavy duty. Overload: $\frac{1.5 \cdot I_{nom-HD}}{1min}$

I_{nom-ND}: inverter rated current for use with the normal duty. Overload: $\frac{1.1 \cdot I_{nom-ND}}{1min}$

Braking IGBT: works as a switch to activate the braking resistors; it is controlled by the DC Link voltage level.

IGBT: Insulated Gate Bipolar Transistor, basic component of the output inverter bridge.

in: inch.

k: kilo (10³)

kg: kilogram = 1000 grams.

l: liters.

lb: pound.

m: If isolated, indicates meter; together with another unit of measurement, indicates milli (10⁻³)

Frame: designation related to the dimension of the product for a certain power range.

FLASH memory: non-volatile memory that can be electronically written and erased.

min: minute.

N.m: newton meter; unit of torque.

NTC: Negative Temperature Coefficient; a component that reduces its electrical resistance when the temperature increases.

PE: Protective Earth.

PTC: Positive Temperature Coefficient; a component that increases its electrical resistance when the temperature increases.

PWM: Pulse Width Modulation.

Normal Duty (ND): refers to the inverter duty cycle with maximum values of current in continuous operation equal to I_{nom-ND} and overload of 110% for 1 minute. It can be configured in C3.9.3 and must be used to drive motors that, in the application, are not subject to high overload torques in relation to their rated torque when operating at constant speed, starting, accelerating or decelerating.

Heavy Duty (HD): refers to the inverter duty cycle with maximum values of current in continuous operation equal to I_{nom-HD} and overload of 150% for 1 minute. It can be configured in C3.9.3 and must be used to drive motors that, in the application, are subject to high overload torques in relation to their rated torque when operating at constant speed, starting, accelerating or decelerating.

Rectifier: inverter input circuit that transforms the input AC voltage into DC, formed by thyristors and/or power

diodes.

rms: Root mean square, effective value.

rpm: revolutions per minute.

s: second.

STO: Safe Torque Off. When the STO function is enabled, the inverter ensures that it will not generate torque on the motor shaft.

SS1-t: Safety Stop 1. When the SS1-t function is enabled, the inverter starts decelerating the motor and enables the STO function after a specified time.

TBD: value to be defined.

USB: Universal Serial Bus; is a serial bus standard that allows devices to be connected using the "Plug and Play" concept.

V: volts.

Varistor: metal oxide varistor.

Ω: ohms.

μ: micro (10^{-6})

2.3 ABOUT THE CFW900

The CFW900 frequency inverter is a high-performance product that allows speed and torque control of low-voltage three-phase motors. The main features of this product are the on-board technology, which allows the flexible solution of different types of application, and its connectivity. To this end, it has the following functionalities:

- Vector control (Sensorless and Encoder) for induction motors, scalar control (V/F or VVW) for induction motors and VVW scalar control for permanent magnet (PM) motors.
- Built-in Ethernet and RS485 communication interfaces. Other communication interfaces available via accessories.
- Advanced Energy Saving Function that reduces motor losses and improves the system performance.
- Thermal Management Function that acts on the inverter to protect the equipment integrity and functionality.
- Specific PWM Modulation function for use with Long Cables at the inverter output to the motor.
- DC Braking function to optimize the inverter stop. It can also be used as a motor warm-up function in specific cases.
- Dynamic Braking function and vector control Optimal Braking. Optimal Braking enables the controlled braking of the motor, eliminating the braking resistor in some applications.
- Flying Start function that allows driving a motor on the fly, accelerating it from the speed at which it is running.
- Ride-Through function that allows recovering the inverter, without undervoltage locking, when a power failure occurs for a brief time.
- Oriented start-up (Assistant) function groups and allows the definition of the main parameters for the inverter operation.
- Self-Tuning function (Assistant) for the vector control allows the automatic setting of the regulators and control parameters, from the identification (also automatic) of the motor and load parameters.

By navigating the CFW900 HMI, it is possible to set the parameters through the navigation groups: Status, Diagnostics and Configurations. From these three groups, you can access the product identification, measurements (voltages, currents, temperatures etc.), protection and alarm diagnostics (active protection/present, time control etc.) and inverter configurations (power supply, motor data, control used, commands and references etc.).

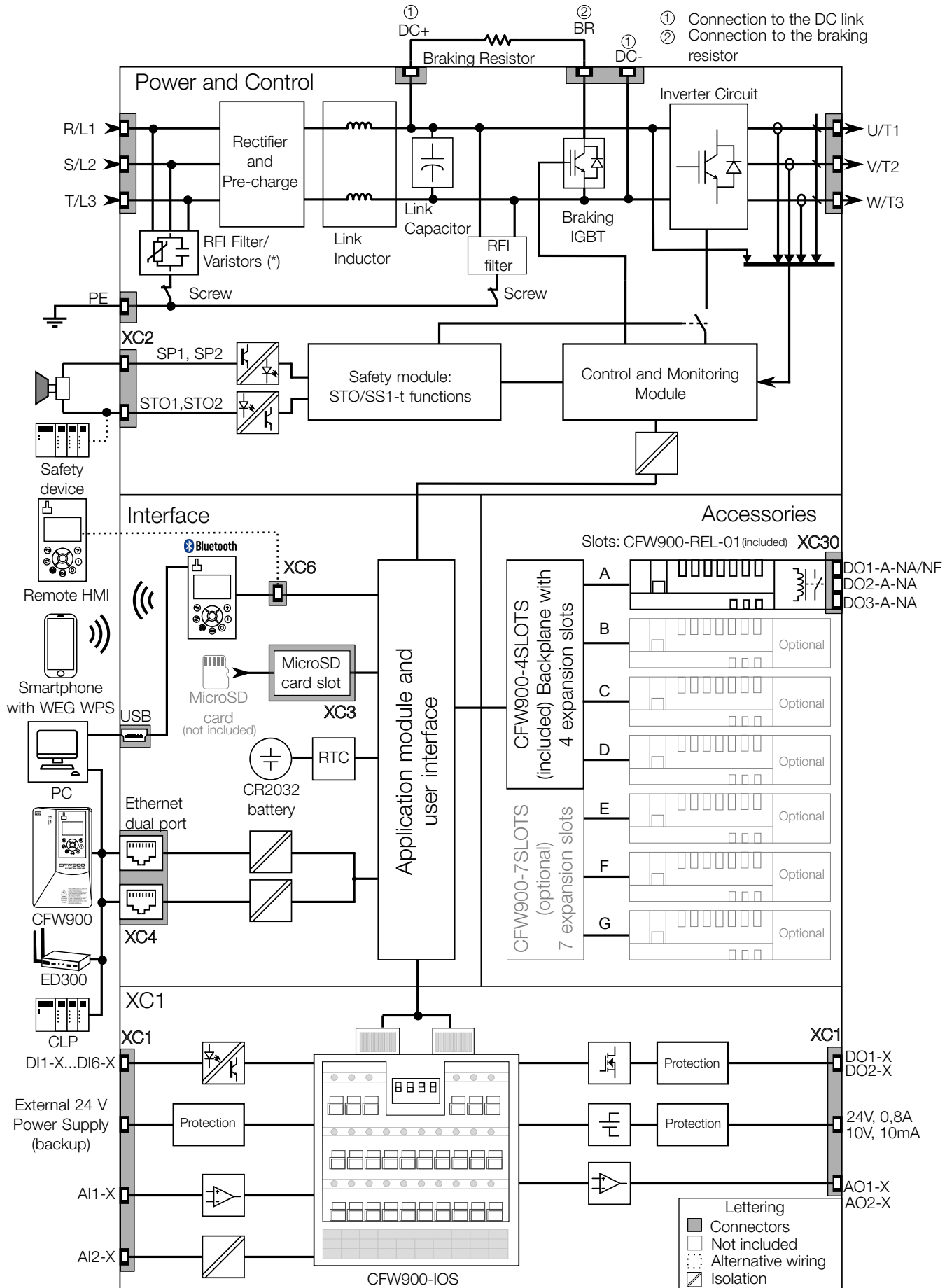

(* All models have a built-in RFI filter.

Figure 2.1: Block diagram for the CFW900

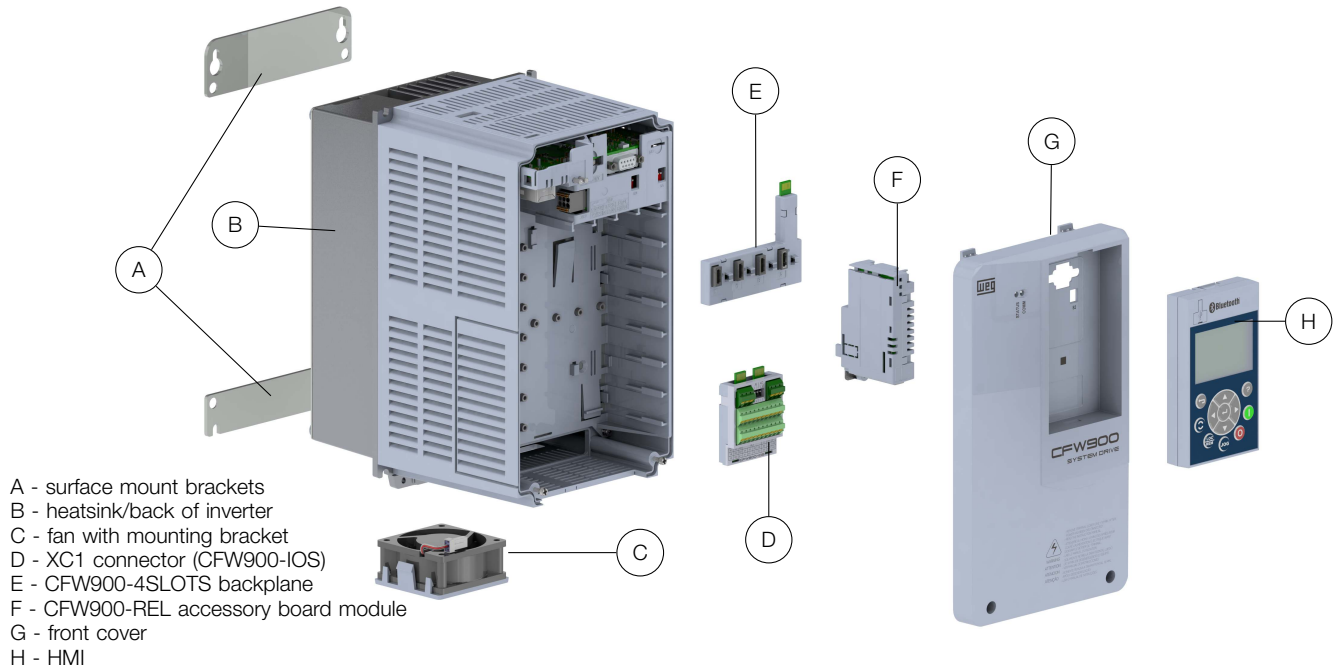

Figure 2.2: Main components

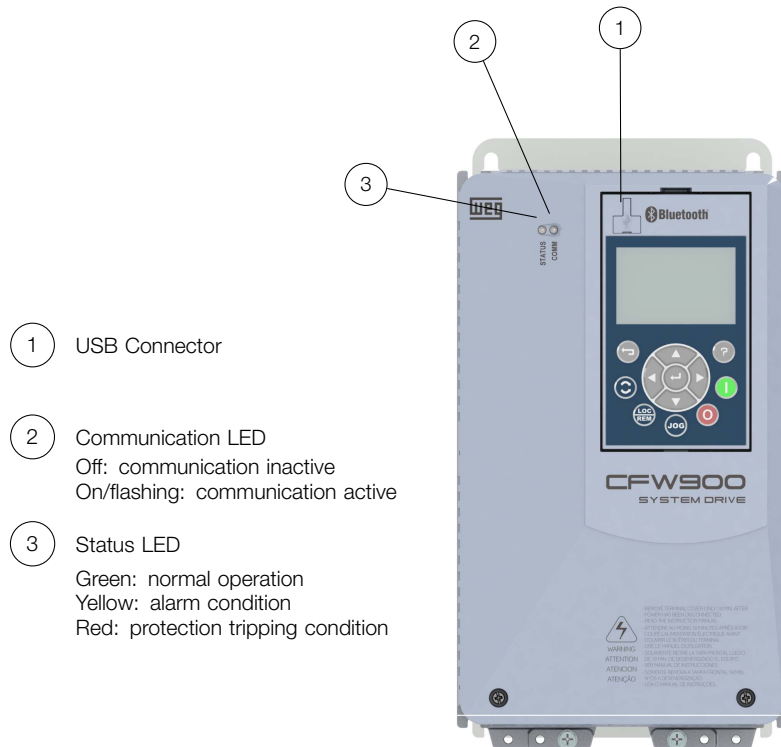
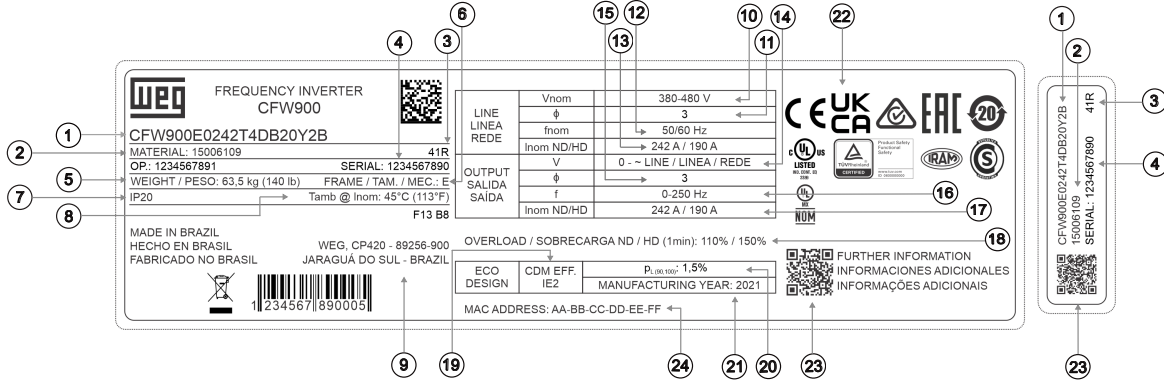

Figure 2.3: LEDs and USB connector

2.3.1 Identification Labels

There are two identification labels on the CFW900: a complete one, located on the side of the inverter and a condensed one, under the HMI. The label under the HMI brings the most important data even on inverters mounted side by side.



- (1) Smart code of the inverter;
- (2) WEG stock item;
- (3) Week and year of product manufacture (encoded);
- (4) Inverter serial number;
- (5) Inverter weight;
- (6) Frame size;
- (7) Degree of protection;
- (8) Rated operating temperature;
- (9) Manufacturer's address;
- (10) Nominal input voltage range;
- (11) Number of input phases;
- (12) Rated input frequency;
- (13) Inverter input current rated (ND and HD overload regime);
- (14) Output voltage range;
- (15) Number of output phases;
- (16) Output frequency range (considering manufacturer's settings);
- (17) Inverter output current rated (ND and HD overload regime);
- (18) Inverter overload specification for ND and HD;
- (19) Efficiency class according to EcoDesign Directive;
- (20) Inverter losses at rated condition (90,100);
- (21) Manufacturing year;
- (22) Inverter certifications;
- (23) Inverter QR code;
- (24) Inverter MAC address.

Figure 2.4: Description of the identification label on the CFW900

Table 2.1: Identification of the CFW900 smart code

CFW900	D	90P0	T	4	DB	20	Y2	B	-	-	-
I	II	III	IV	V	VI	VII	VIII	IX	X	XI	XII
Item	Description										
I	Product series identification: CFW900										
II	Frame Size: A, B, C, D or E										
III	ND current rated value: 02P8 = 2.8 A 03P6 = 3.6 A ... 0110 = 110 A 0135 = 135 A ...										
IV	Number of power supply phases: B = Single-phase or three-phase T = Three-phase only										
V	Power supply voltage: 2 = 200 to 240 Vac (frame sizes A, B and C), 208 to 240 Vac (frame sizes D and E) 4 = 380 to 480 Vac										
VI	Braking: NB = Without braking IGBT (frame sizes D and E) DB = With braking IGBT										
VII	Degree of protection: 20 = IP20 21 = IP21 N1 = UL type 1										
VIII	Functional safety: Y2 = With STO and SS1-t safety functions										
IX	HMI: Blank = HMI without Bluetooth B = HMI with Bluetooth										
X	Product with special hardware version: Blank = Standard hardware HEC = Product with extra-coating board Hx, Hxx or Hxxx = Other types of special hardware										
XI	Product with special software/firmware version: Blank = Standard software/firmware Sx, Sxx or Sxxx = Special software/firmware										
XII	Factory suffix: Blank = standard -UI = inverter supplied without package (returnable packaging) -Gx = Group item x										

2.3.2 Receiving and Storage

The CFW900 is supplied in a cardboard box up to frame C models; the others are supplied in a wooden box.

The package bears an identification label that must be identical to the one affixed to the side of the inverter.

Upon receiving the product, check if:

- The CFW900 identification label matches the purchased model.
- Any damage occurred during transportation.

Report any damage immediately to the carrier.

GENERAL INFORMATION

If the CFW900 is not installed soon, store it in a clean and dry location (temperature between -25 °C and 60 °C (-13 °F and 140 °F), with a cover to prevent dust accumulation inside it.

**WARNING!**

When the inverter is stored for a long period, it becomes necessary to perform the capacitor reforming. Refer to the procedure in the [Section 6.6](#) of this manual.

3 INSTALLATION AND CONNECTION

This chapter provides information on installing and wiring the CFW900. The instructions and guidelines listed in this manual shall be followed to guarantee personnel and equipment safety, as well as the proper operation of the inverter.

3.1 MECHANICAL INSTALLATION

3.1.1 Environmental Conditions

**NOTE!**

This product is designed for use in sheltered places only.

Avoid:

- Direct exposure to sunlight, rain, high humidity, or sea-air.
- Inflammable or corrosive gases or liquids.
- Excessive vibration.
- Dust, metallic particles, and oil mist.

Environment conditions for the operation:

- The maximum rated ambient temperature at the back of the inverter (around the heatsink) is:
 - 10 °C to 45 °C (14 °F to 113 °F) for frame E models.
 - 10 °C to 50 °C (14 °F to 122 °F) for other frames.Operation at temperatures above the rated one is possible; however, in these cases, the output current must be derated, as described in [Section 8.2](#).
- The maximum rated ambient temperature on the front of the inverter is 60 °C for all models, except for the models indicated in [Section 8.1.4](#).
- Humidity: from 5 % to 95 % non-condensing.
- Maximum altitude: up to 1000 m (3,300 ft) rated conditions. Operation at an altitude of up to 4000 m is possible, however, in these cases, the rated output current and supply voltage must be derated as per [Section 8.2](#).
- Pollution degree: 2 (according to EN50178 and UL61800-5), with non-conductive pollution. Condensation shall not originate conduction the accumulated residues.

3.1.2 Positioning and Mounting

Consult the inverter weight at the [Section 8.4](#).

Mount the inverter in the upright position on a flat and vertical surface. Frames A ...C can be installed horizontally as long as the recommendations of [Figure 3.3](#).

External dimensions and fixing holes position according to the [Figure 3.1](#). Refer to [Section 8.4](#) for further details.

First mark the mounting points and drill the mounting holes. Then, position the inverter and firmly tighten the screws in all four corners to secure the inverter.

Minimum mounting clearances requirements for proper cooling air circulation are specified in [Figure 3.2](#) and [Table 3.3](#).

Inverters of frames A ... D can be arranged side-by-side with no clearance required between them. In these cases, the upper ventilation openings must be free for air circulation, that is, it is not possible to use the IP21 and UL type 1 kits.

Do not install heat sensitive components right above the inverter.



WARNING!

- When one inverter is installed above another, use the minimum distance $A + B$, as shown in [Figure 3.2](#), and divert the hot air blown by the lower inverter from the upper inverter.
- Provide conduit for physical separation of the signal, control, and power conductors (refer to [Section 3.2](#)).

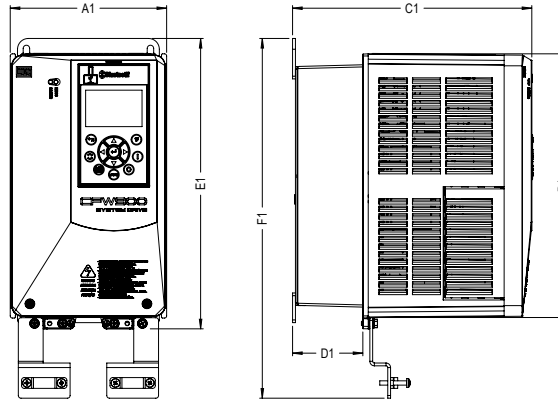

a) External dimensions.

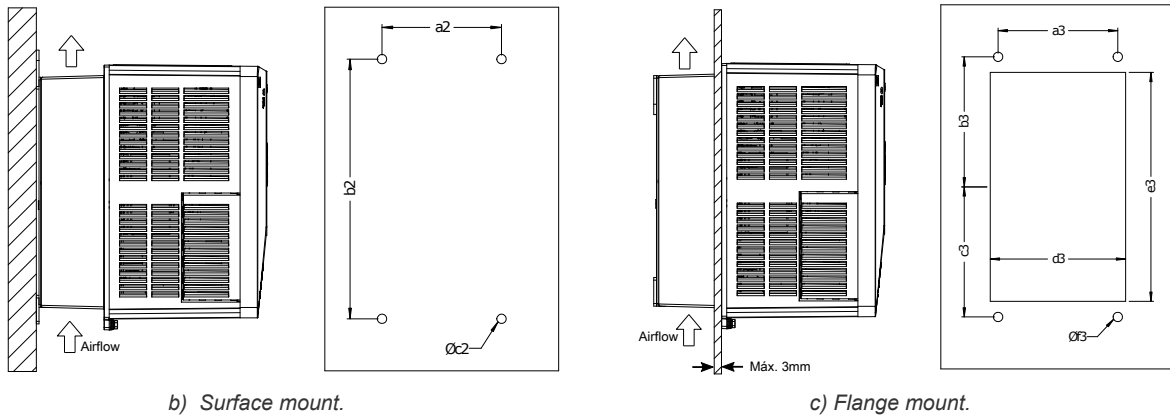

b) Surface mount.

c) Flange mount.

Figure 3.1: External dimensions of the inverters

Table 3.1: External dimensions of the inverters

Model	A1 mm [in]	B1 mm [in]	C1 mm [in]	D1 mm [in]	E1 mm [in]	F1 mm [in]	a2 mm [in]	b2 mm [in]	a3 mm [in]	b3 mm [in]	c3 mm [in]	d3 mm [in]	e3 mm [in]
Frame A	145 [5.7]	245 [9.65]	222 [8.74]	65 [2.56]	269 [10.59]	333.5 [13.13]	115 [4.53]	250 [9.84]	124 [4.88]	120 [4.72]	120 [4.72]	138 [5.43]	228 [8.97]
Frame B	165.2 [6.5]	359.3 [14.15]	228 [8.98]	70.2 [2.76]	385 [15.16]	448.9 [17.67]	125 [4.92]	369.3 [14.54]	150 [5.9]	177.1 [6.97]	177.1 [6.97]	158 [6.22]	342 [13.46]
Frame C	200 [7.87]	430 [16.92]	294 [11.57]	136.4 [5.37]	460 [18.11]	519.3 [20.45]	150 [5.9]	425 [16.73]	175 [6.89]	210 [8.27]	210 [8.27]	188 [7.4]	405 [15.95]
Frame D	250 [9.84]	602 [23.7]	294 [11.57]	135 [5.31]	625 [24.6]	700 [27.56]	200 [7.87]	600 [23.6]	220 [8.66]	290 [11.41]	298 [11.73]	238 [9.37]	565 [22.24]
Frame E	335 [13.19]	620 [24.4]	358 [14.09]	169 [6.65]	675 [26.57]	763.4 [29]	200 [7.87]	650 [25.6]	275 [10.83]	318.5 [12.54]	318.5 [12.54]	316 [12.44]	620 [24.41]

*Tolerance of the dimensions d3 and e3: + 1.0 mm (+ 0.039 in)

*Tolerance of the other dimensions: ± 1.0 mm (± 0.039 in)

Table 3.2: Screws for the fixing holes

Model	c2	f3	Torque ⁽¹⁾
	M	M	N.m [lbf.in]
Frame A	M5	M5	5 [44.2]
Frame B	M5	M5	5 [44.2]
Frame C	M6	M6	8.5 [75.2]
Frame D	M8	M8	20 [177]
Frame E	M8	M8	20 [177]

⁽¹⁾ Recommended torque for inverter fixing

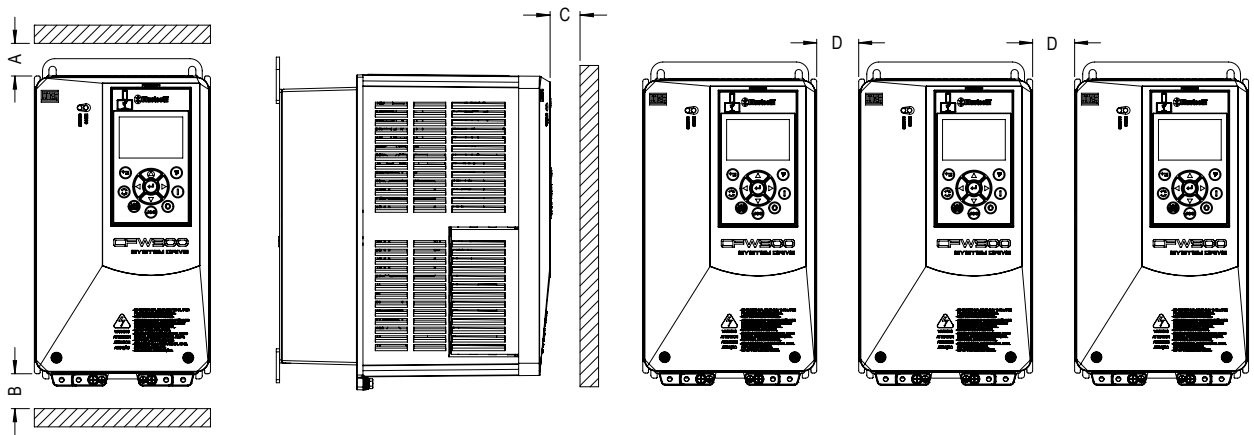

Figure 3.2: Free clearances for ventilation

Table 3.3: Free clearances for ventilation

Frame Size	Protection rating	A mm [in]	B mm [in]	C mm [in]	D mm [in]
A	IP20	25 [0.98]	25 [0.98]	10 [0.39]	0 [0]
	IP21 / UL type 1	25 [0.98]	25 [0.98]	10 [0.39]	30 [1.18]
B	IP20	40 [1.57]	45 [1.77]	10 [0.39]	0 [0]
	IP21 / UL type 1	40 [1.57]	45 [1.77]	10 [0.39]	30 [1.18]
C	IP20	110 [4.33]	130 [5.12]	10 [0.39]	0 [0]
	IP21 / UL type 1	110 [4.33]	130 [5.12]	10 [0.39]	30 [1.18]
D	IP20	110 [4.33]	130 [5.12]	10 [0.39]	0 [0]
	IP21 / UL type 1	110 [4.33]	130 [5.12]	10 [0.39]	30 [1.18]
E	IP20	150 [5.9]	250 [9.84]	20 [0.79]	0 [0]
	IP21 / UL type 1	150 [5.9]	250 [9.84]	20 [0.79]	30 [1.18]

3.1.3 Horizontal Mounting

Frames A ... C can be mounted horizontally without derating the output current. The correct mounting position is shown in [Figure 3.3](#).

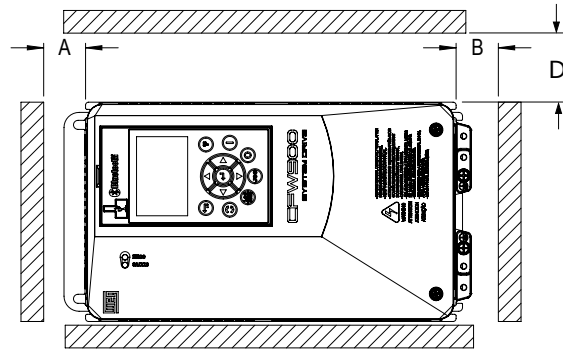

Figure 3.3: Horizontal mounting (See Table 3.3)

3.1.4 Cabinet Mounting

It is possible to mount the inverters: on a surface or a flange. To that end, the following considerations must be taken into account:

3.1.4.1 Surface Mounting

- Provide adequate exhaustion so that the internal cabinet temperature is kept within the allowable operating range of the inverter.
- The power dissipated by the inverter at its rated condition and the heatsink fan flow at the operation point are specified in [Chapter 8](#).
- The position and diameter of the mounting holes, according to [Figure 3.1](#).



WARNING!

UL type 1 inverters support surface mounting only.

3.1.4.2 Flange Mounting

In the flange-mounting type, the back of the inverter (which contains the heatsink and fan) is installed outside the panel. Therefore, the power module cooling air is kept outside the cabinet.

- The mounting brackets must be removed and repositioned as shown in [Figure 3.4](#).
- Dimensions of the opening for mounting the back of the product, position and diameter of the mounting holes, as shown in [Figure 3.1](#).
- The portion of the inverter that is located outside the cabinet is rated IP55 / UL type 12. To ensure that the cabinet degree of protection is maintained, adequate sealing must be provided between the panel opening and the drive flange. Example: silicone gasket.

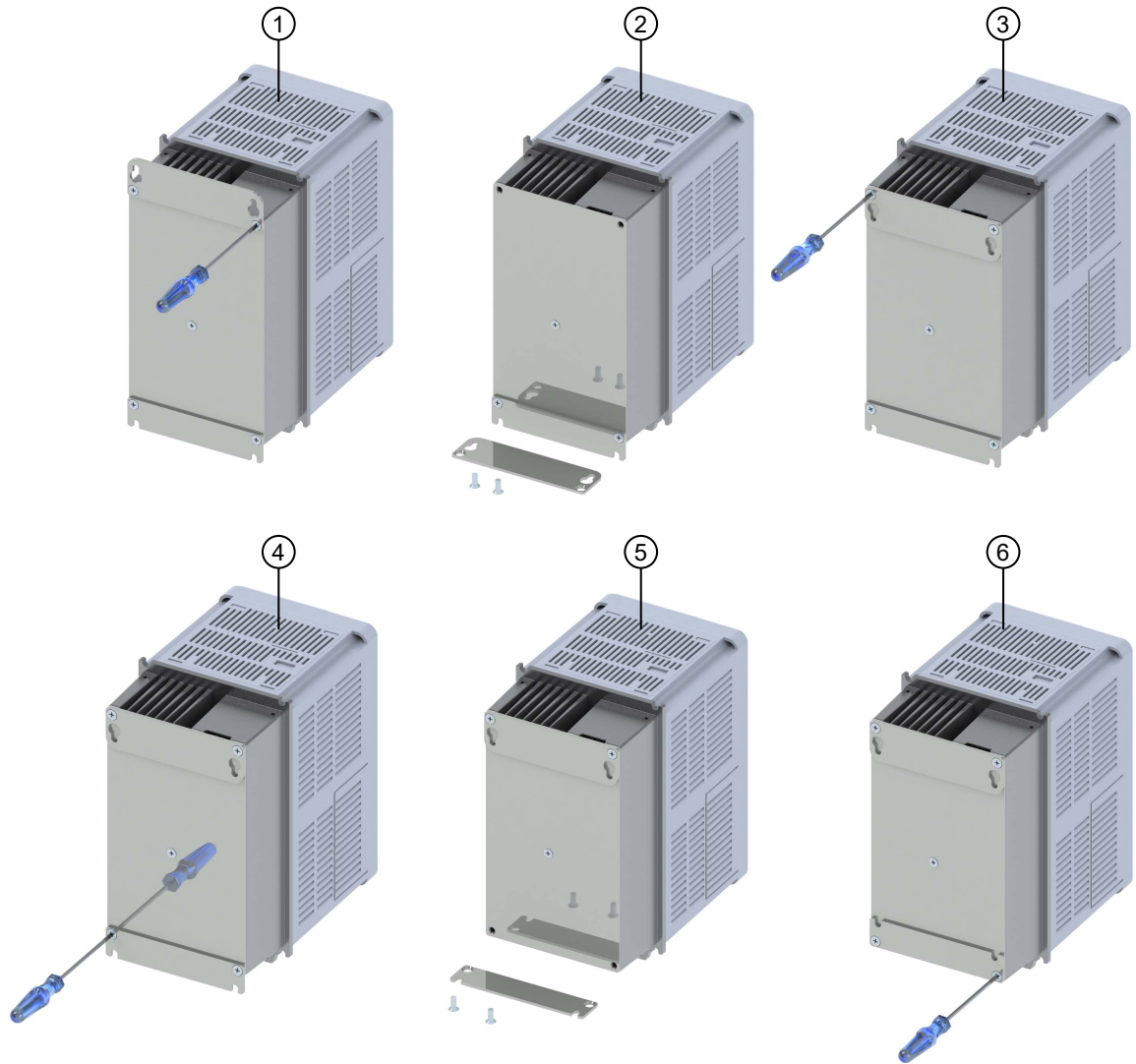

Figure 3.4: Repositioning of the mounting brackets

3.1.5 Access to Control and Power Terminals

In CFW900 inverters of frames A, B, C and D, it is necessary to remove the HMI and the front cover to access the control and power terminals, as shown in [Figure 3.5](#).

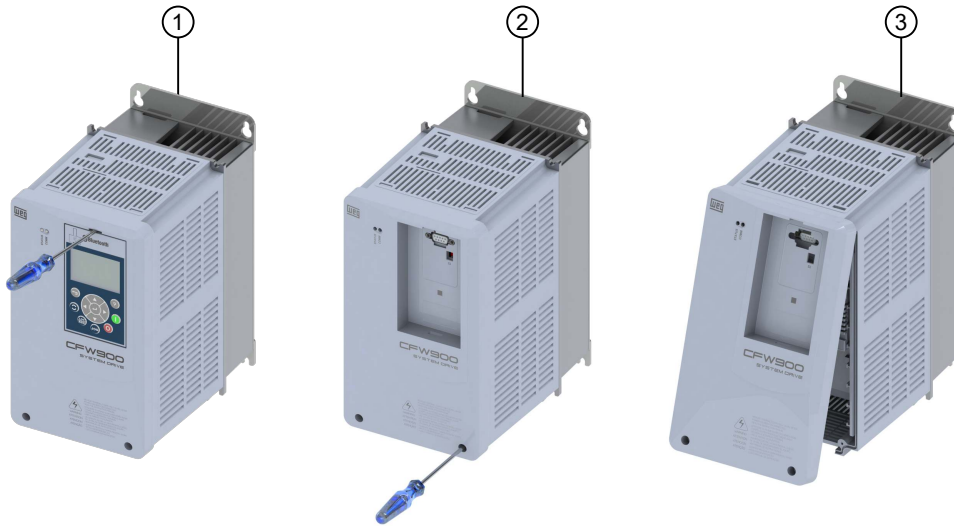

Figure 3.5: Removal of HMI and front cover

In case of inverters of frame size E, it is necessary to remove the HMI and control rack cover to access the control connectors (see Figure 3.6). In order to access the power connectors, remove the lower front cover as shown in Figure 3.7.

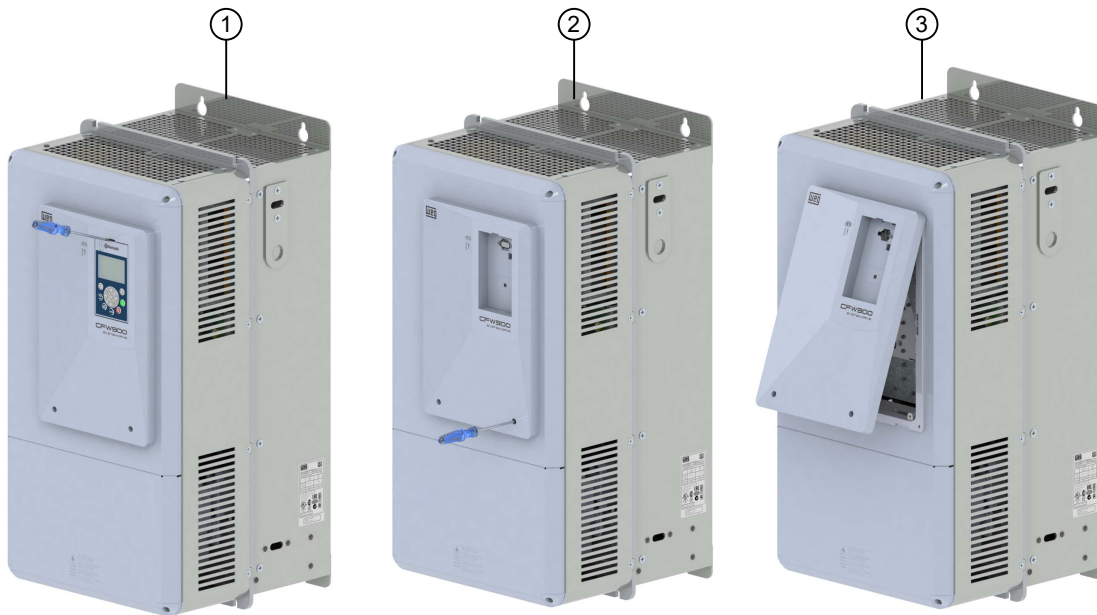

Figure 3.6: HMI and control rack cover removal

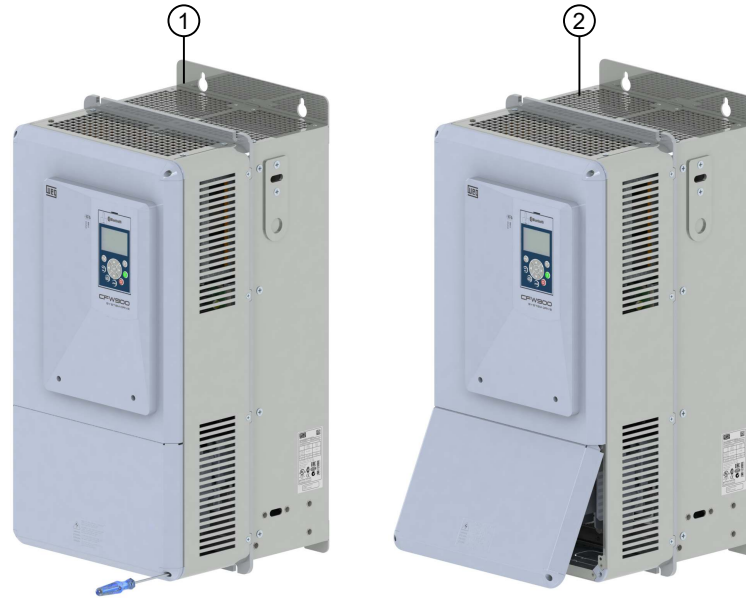

Figure 3.7: Bottom front cover removal

3.1.6 HMI Installation at the Cabinet Door or Command Panel (Remote HMI)

The dimensions necessary to assemble the HMI on the panel door or control table are shown in Figure 3.8. If you prefer, the frame accessory can also be used to fix the HMI in these places.

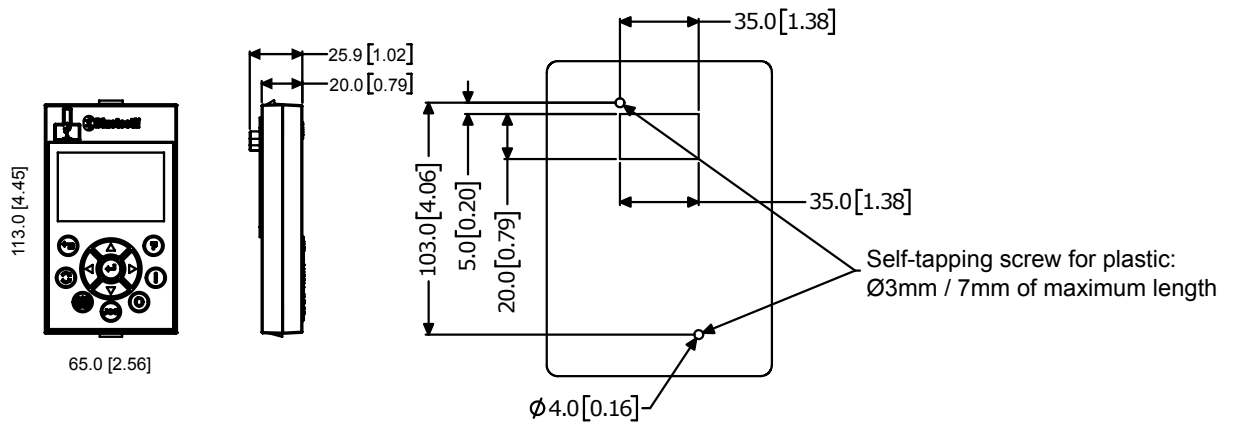

Figure 3.8: Data for the HMI installation at the cabinet door or command panel - mm [in]

3.2 ELECTRICAL INSTALLATION



DANGER!

- The following information is merely a guide for proper installation. Comply with applicable regulations for electrical installations.
- Make sure the AC power supply is disconnected before starting the installation.

**WARNING!**

The short-circuit protection of the inverter does not provide short-circuit protection for the feeder circuit. The short-circuit protection of the feeder circuit must be provided in accordance with applicable local regulations.

3.2.1 Identification of the Power and Grounding Terminals**NOTE!**

Models CFW900A04P5B2, CFW900A06P0B2, CFW900A07P3B2 and CFW900A10P0B2 may operate with single-phase power supply without rated output derating. In this case, the single-phase power supply may be connected to two of any input terminals.

The power terminals can be of different sizes and configurations depending on the inverter model. The location of the power and grounding connections are indicated in [Figures 3.9 and 3.17](#).

Description of the power terminals:

- **R/L1, S/L2, T/L3:** AC power supply network cable connection.
- **DC-/-UD:** negative pole of the DC power supply.
- **BR:** braking resistor connection.
- **DC+ /+UD:** positive pole of the DC power supply.
- **U, V and W:** motor cable connection.

The maximum tightening torque of the power terminals and grounding points must be checked in [Table 3.4](#).

**DANGER!**

Observe correct DC power connection, polarity and position of the terminals.

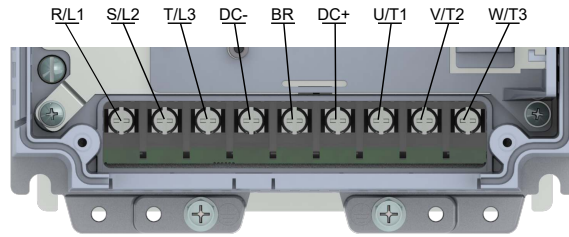

(a) Frame Sizes A, B and C

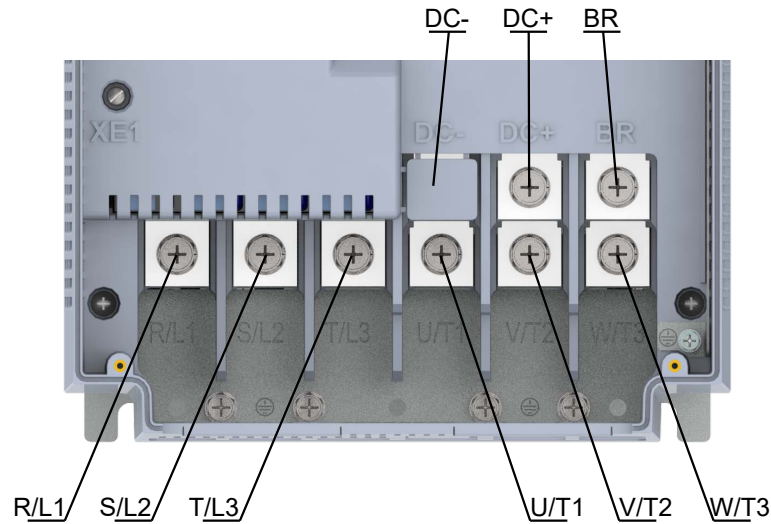

(b) Frame Size D

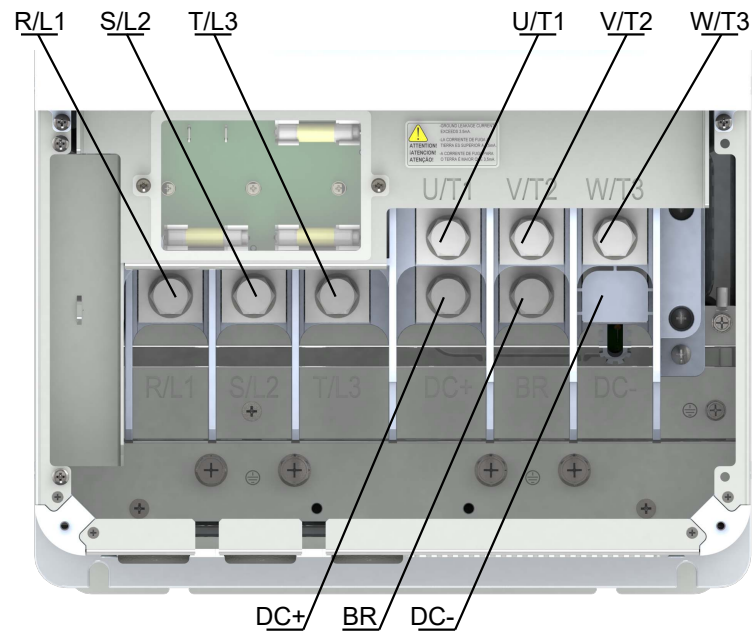

(c) Frame Size E

Figure 3.9: Power terminals

To ensure the IP20 protection rating in frame C when powered by the DC link without using the braking resistor, break the flaps of the cover protecting the DC+, DC- and BR terminals and insert this new cover to seal the BR terminal, as shown in [Figure 3.10](#). In this case, the cover of terminals R/L1, S/L2 and T/L3 must be kept.

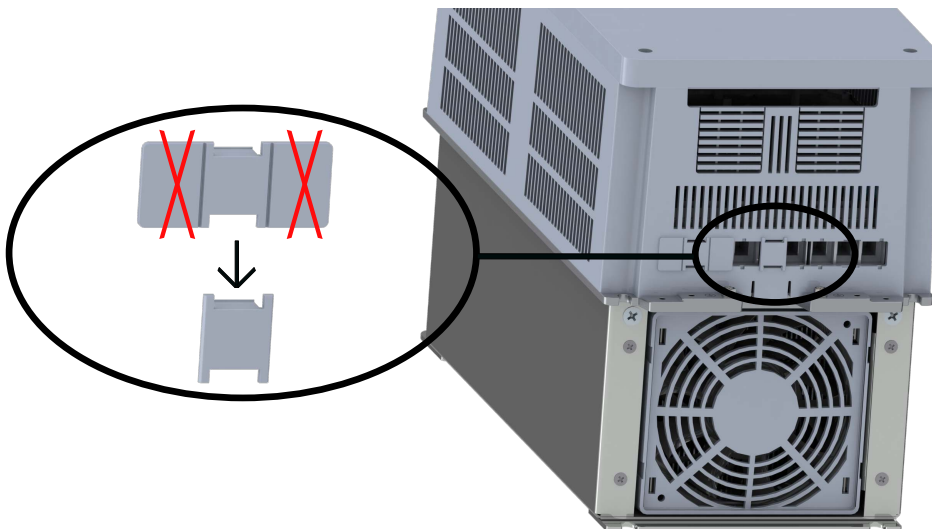

Figure 3.10: BR terminal protection for DC link supply - frame C

3.2.2 Power and Grounding Wiring



WARNING!

When power and ground connections are made with flexible cables, it is necessary to use suitable terminals.



WARNING!

Sensitive equipment, such as PLCs, temperature controllers and thermocouple cables, should be at least 0.25 meters away from the frequency inverters and cables connecting the inverter to the motor.



DANGER!

Wrong cable connection:

















- The inverter will be damaged in case the input power supply is connected to the output terminals (U/T1, V/T2, or W/T3)
- Check all the connections before powering up the inverter.
- In case of replacing an existing inverter by a CFW900, check if the installation and wiring is according to the instructions listed in this manual.



NOTE!

- The wire gauges listed in [Table 3.4](#) are orientative values. Installation conditions and the maximum permitted voltage drop must be considered for the proper wiring sizing.

















Table 3.4: Recommended wire size - Use only copper wire (75 °C (167 °F))

Model	Power Terminals			Wire size		
	Terminals	Screw (type)	Recommended Torque N.m (lbf.in)	mm ²	AWG	Terminal type
CFW900A04P6B2	Power ⁽¹⁾	M4 (phillips/ slotted)	1.2 (10.6)	2.5	14	Fork 
	Grounding ⁽²⁾	M4 (phillips)				Lug 
CFW900A06P0B2	Power ⁽¹⁾	M4 (phillips/ slotted)	1.2 (10.6)	2.5	14	Fork 
	Grounding ⁽²⁾	M4 (phillips)				Lug 
CFW900A07P5B2	Power ⁽¹⁾	M4 (phillips/ slotted)	1.2 (10.6)	2.5/4 ⁽³⁾	14/12 ⁽³⁾	Fork 
	Grounding ⁽²⁾	M4 (phillips)		4.0	12	Lug 
CFW900A10P0B2	Power ⁽¹⁾	M4 (phillips/ slotted)	1.2 (10.6)	2.5/6 ⁽³⁾	14/10 ⁽³⁾	Fork 
	Grounding ⁽²⁾	M4 (phillips)		6.0	10	Lug 
CFW900A04P6T2	Power ⁽¹⁾	M4 (phillips/ slotted)	1.2 (10.6)	2.5	14	Fork 
	Grounding ⁽²⁾	M4 (phillips)				Lug 
CFW900A06P0T2	Power ⁽¹⁾	M4 (phillips/ slotted)	1.2 (10.6)	2.5	14	Fork 
	Grounding ⁽²⁾	M4 (phillips)				Lug 
CFW900A07P5T2	Power ⁽¹⁾	M4 (phillips/ slotted)	1.2 (10.6)	2.5	14	Fork 
	Grounding ⁽²⁾	M4 (phillips)				Lug 
CFW900A10P6T2	Power ⁽¹⁾	M4 (phillips/ slotted)	1.2 (10.6)	2.5	14	Fork 
	Grounding ⁽²⁾	M4 (phillips)				Lug 

⁽¹⁾ R/L1 ; S/L2 ; T/L3 ; U/T1 ; V/T2 ; W/T3 ; DC+ ; DC-.











⁽²⁾ PE.

⁽³⁾ The first value is for 3-phase power supply and motor connection, and the second value is for single-phase power supply.

Model	Power Terminals			Wire size		
	Terminals	Screw (type)	Recommended Torque N.m (lbf.in)	mm ²	AWG	Terminal type
CFW900A13P0T2	Power ⁽¹⁾	M4 (phillips/ slotted)	1.2 (10.6)	4.0	12	Fork 
	Grounding ⁽²⁾	M4 (phillips)				Lug 
CFW900A19P0T2	Power ⁽¹⁾	M4 (phillips/ slotted)	1.2 (10.6)	4.0	10	Fork 
	Grounding ⁽²⁾	M4 (phillips)				Lug 
CFW900B26P0T2	Power ⁽¹⁾	M4 (phillips/ slotted)	1.2 (10.6)	6.0	8	Wire ferrule 
	Grounding ⁽²⁾	M4 (phillips)				Lug 
CFW900B34P0T2	Power ⁽¹⁾	M4 (phillips/ slotted)	1.2 (10.6)	10.0	8	Wire ferrule 
	Grounding ⁽²⁾	M4 (phillips)				Lug 
CFW900B45P0T2	Power ⁽¹⁾	M4 (phillips/ slotted)	1.2 (10.6)	16.0	6	Wire ferrule 
	Grounding ⁽²⁾	M4 (phillips)				Lug 
CFW900C56P0T2	Power ⁽¹⁾	M4 (phillips/ slotted)	3.7 (32.8)	25.0	4	Wire ferrule 
	Grounding ⁽²⁾	M4 (phillips)		16.0		Lug 
CFW900C70P0T2	Power ⁽¹⁾	M4 (phillips/ slotted)	3.7 (32.8)	25.0	4	Wire ferrule 
	Grounding ⁽²⁾	M4 (phillips)		16.0		Lug 
CFW900C80P0T2	Power ⁽¹⁾	M4 (phillips/ slotted)	3.7 (32.8)	35.0	3	Wire ferrule 
	Grounding ⁽²⁾	M4 (phillips)		16.0		Lug 

















⁽¹⁾ R/L1 ; S/L2 ; T/L3 ; U/T1 ; V/T2 ; W/T3 ; DC+ ; DC-.

⁽²⁾ PE.

Model	Power Terminals			Wire size		
	Terminals	Screw (type)	Recommended Torque N.m (lbf.in)	mm ²	AWG	Terminal type
CFW900D0110T2	Power ⁽¹⁾	M8 (Hexagonal /Phillips/ screw)	15 (132.8)	50	1/0	Lug 
	Grounding ⁽²⁾	M6 (Hexagonal/Phillips screw)	5 (44.2)	35	3	
CFW900D0135T2	Power ⁽¹⁾	M8 (Hexagonal /Phillips/ screw)	15 (132.8)	70	2/0	Lug 
	Grounding ⁽²⁾	M6 (Hexagonal/Phillips screw)	5 (44.2)	35	3	
CFW900D0150T2	Power ⁽¹⁾	M8 (Hexagonal /Phillips/ screw)	15 (132.8)	95	3/0	Lug 
	Grounding ⁽²⁾	M6 (Hexagonal/Phillips screw)	5 (44.2)	35	3	
CFW900E0172T2	Power ⁽¹⁾	M10 (Hexagonal screw)	30 (265.5)	HD: 95 ou 2x25 ND: 95 ou 2x35	HD: 3/0 ou 2x3 ND: 4/0 ou 2x2	Lug 
	Grounding ⁽²⁾	M5 e M8 (Hexagonal/Phillips screw)	M5: 3.5 (31.0) M8: 15 (132.8)	50	1/0	
CFW900E0195T2	Power ⁽¹⁾	M10 (Hexagonal screw)	30 (265.5)	HD: 95 ou 2x35 ND: 120 ou 2x50	HD: 3/0 ou 2x3 ND: 250 ou 2x1	Lug 
	Grounding ⁽²⁾	M5 e M8 (Hexagonal/Phillips screw)	M5: 3.5 (31.0) M8: 15 (132.8)	70	2/0	
CFW900E0250T2	Power ⁽¹⁾	M10 (Hexagonal screw)	30 (265.5)	HD: 150 ou 2x50 ND: 2x70	HD: 250 ou 2x1 ND: 2x2/0	Lug 
	Grounding ⁽²⁾	M5 e M8 (Hexagonal/Phillips screw)	M5: 3.5 (31.0) M8: 15 (132.8)	95	3/0	
CFW900A02P8T4	Power ⁽¹⁾	M4 (phillips/ slotted)	1.2 (10.6)	2.5	14	Fork 
	Grounding ⁽²⁾	M4 (phillips)				
CFW900A03P6T4	Power ⁽¹⁾	M4 (phillips/ slotted)	1.2 (10.6)	2.5	14	Fork 
	Grounding ⁽²⁾	M4 (phillips)				
CFW900A04P8T4	Power ⁽¹⁾	M4 (phillips/ slotted)	1.2 (10.6)	2.5	14	Fork 
	Grounding ⁽²⁾	M4 (phillips)				
CFW900A06P5T4	Power ⁽¹⁾	M4 (phillips/ slotted)	1.2 (10.6)	2.5	14	Fork 
	Grounding ⁽²⁾	M4 (phillips)				Lug 









⁽¹⁾ R/L1 ; S/L2 ; T/L3 ; U/T1 ; V/T2 ; W/T3 ; DC+ ; DC-

⁽²⁾ PE.

Model	Power Terminals			Wire size		
	Terminals	Screw (type)	Recommended Torque N.m (lbf.in)	mm ²	AWG	Terminal type
CFW900A09P6T4	Power ⁽¹⁾	M4 (phillips/ slotted)	1.2 (10.6)	2.5	14	Fork 
	Grounding ⁽²⁾	M4 (phillips)				Lug 
CFW900A14P0T4	Power ⁽¹⁾	M4 (phillips/ slotted)	1.2 (10.6)	4.0	12	Fork 
	Grounding ⁽²⁾	M4 (phillips)				Lug 
CFW900A17P0T4	Power ⁽¹⁾	M4 (phillips/ slotted)	1.2 (10.6)	4.0	10	Fork 
	Grounding ⁽²⁾	M4 (phillips)				Lug 
CFW900B26P0T4	Power ⁽¹⁾	M4 (phillips/ slotted)	1.2 (10.6)	6.0	8	Wire ferrule 
	Grounding ⁽²⁾	M4 (phillips)				Lug 
CFW900B33P0T4	Power ⁽¹⁾	M4 (phillips/ slotted)	1.2 (10.6)	10.0	8	Wire ferrule 
	Grounding ⁽²⁾	M4 (phillips)				Lug 
CFW900B39P0T4	Power ⁽¹⁾	M4 (phillips/ slotted)	1.2 (10.6)	10.0	8	Wire ferrule 
	Grounding ⁽²⁾	M4 (phillips)				Lug 
CFW900C50P0T4	Power ⁽¹⁾	M5 (pozidriv)	3.7 (32.8)	16.0	6	Wire ferrule 
	Grounding ⁽²⁾	M4 (phillips)				Lug 
CFW900C62P0T4	Power ⁽¹⁾	M5 (pozidriv)	3.7 (32.8)	25.0	4	Wire ferrule 
	Grounding ⁽²⁾	M4 (phillips)		16.0	4	Lug 

⁽¹⁾ R/L1 ; S/L2 ; T/L3 ; U/T1 ; V/T2 ; W/T3 ; DC+ ; DC-.

⁽²⁾ PE.

Model	Power Terminals			Wire size		
	Terminals	Screw (type)	Recommended Torque N.m (lbf.in)	mm ²	AWG	Terminal type
CFW900C70P0T4	Power ⁽¹⁾	M5 (pozidriv)	3.7 (32.8)	25.0	3	Wire ferrule 
	Grounding ⁽²⁾	M4 (phillips)		16.0	4	Lug 
CFW900D90P0T4	Power ⁽¹⁾	M8 (Hexagonal/Phillips screw)	15 (132.8)	35	1	Lug 
	Grounding ⁽²⁾	M6 (Hexagonal/Phillips screw)	5 (44.2)	35	3	
CFW900D0123T4	Power ⁽¹⁾	M8 (Hexagonal/Phillips screw)	15 (132.8)	70	2/0	Lug 
	Grounding ⁽²⁾	M6 (Hexagonal/Phillips screw)	5 (44.2)	35	3	
CFW900D0146T4	Power ⁽¹⁾	M8 (Hexagonal/Phillips screw)	15 (132.8)	70	3/0	Lug 
	Grounding ⁽²⁾	M6 (Hexagonal/Phillips screw)	5 (44.2)	35	3	
CFW900E0172T4	Power ⁽¹⁾	M10 (Hexagonal screw)	30 (265.5)	HD: 95 ou 2x25 ND: 95 ou 2x35	HD: 2/0 ou 2x3 ND: 4/0 ou 2x2	Lug 
	Grounding ⁽²⁾	M5 e M8 (Hexagonal/Phillips screw)	M5: 3.5 (31.0) M8: 15 (132.8)	50	1/0	
CFW900E0200T4	Power ⁽¹⁾	M10 (Hexagonal screw)	30 (265.5)	HD: 95 ou 2x35 ND: 120 ou 2x50	HD: 3/0 ou 2x3 ND: 250 ou 2x1	Lug 
	Grounding ⁽²⁾	M5 e M8 (Hexagonal/Phillips screw)	M5: 3.5 (31.0) M8: 15 (132.8)	70	2/0	
CFW900E0240T4	Power ⁽¹⁾	M10 (Hexagonal screw)	30 (265.5)	HD: 120 ou 2x35 ND: 2x70	HD: 4/0 ou 2x1 ND: 2x 1/0	Lug 
	Grounding ⁽²⁾	M5 e M8 (Hexagonal/Phillips screw)	M5: 3.5 (31.0) M8: 15 (132.8)	95	2/0	

⁽¹⁾ R/L1 ; S/L2 ; T/L3 ; U/T1 ; V/T2 ; W/T3 ; DC+ ; DC-.

⁽²⁾ PE.

3.2.3 Fuses, Circuit Breakers and Power Supply Capacity

- The CFW900 is suitable for use in circuits with short circuit capacity of up to 65 kA, which value varies according to the type of protection used (fuse or circuit breaker) and certification considered (UL or CE). For more details, see [Table 3.5](#), [Table 3.6](#) and [Table 3.7](#).
- For IEC conformity, fuses with rated current and I²t less than or equal to the values presented in the [Table 3.5](#) (this table also presents suggestions for WEG fuses) or circuit breakers in the inverter power supply according to the specifications presented in [Table 3.7](#). When a circuit breaker is used, it is necessary to install the inverter inside a metal panel with minimum dimensions according to the values shown in [Table 3.7](#). Some models of fused-protected inverters also require the use of a metal panel - for more details see [Table 3.5](#).
- For UL conformity, fuses must be used in the inverter power supply as shown in [Table 3.6](#) or circuit breakers in the inverter power supply as shown in [Table 3.7](#). Pay attention to the use of a panel, which is required for some inverter models protected with fuses and for all inverter models protected by circuit breaker.

- For frame size models A, B and C time-delay fuses sized for 1.2 x the inverter rated input current can be used on the inverter input. In this case, the installation is protected against short-circuit, but not the inverter input rectifier.

Table 3.5: Fuse specifications as per IEC standards

Model	Maximum Short-Circuit Current of the Power Supply [kA]	Panel	Protection with High Speed Fuses						
			I ² t of the diode [A ² s]	Fuse Rated Current [A]	AC Power Supply			DC Power Supply	
					Recommended WEG aR FNH blade contact type fuses			Fuse Rated Current [A]	Fuse Recommendation
Size	WEG Reference	SAP code							
CFW900A04P6B2	5 without panel 65 with panel ⁽¹⁾	Depends on the maximum short-circuit current of the grid	300	15	000	FNH000-20K-A	13735555	35	Mersen A70QS35-4
CFW900A06P0B2			300	15	000	FNH000-20K-A	13735555	35	Mersen A70QS35-4
CFW900A07P5B2			300	15	000	FNH000-20K-A	13735555	35	Mersen A70QS35-4
CFW900A10P0B2			685	20	000	FNH000-20K-A	13735555	35	Mersen A70QS35-4
CFW900A04P6T2			300	15	000	FNH000-20K-A	13735555	35	Mersen A70QS35-4
CFW900A06P0T2			300	15	000	FNH000-20K-A	13735555	35	Mersen A70QS35-4
CFW900A07P5T2			300	15	000	FNH000-20K-A	13735555	35	Mersen A70QS35-4
CFW900A10P6T2			300	20	000	FNH000-20K-A	13735555	35	Mersen A70QS35-4
CFW900A13P0T2			300	20	000	FNH000-20K-A	13735555	35	Mersen A70QS35-4
CFW900A19P0T2			685	25	000	FNH000-35K-A	13737105	35	Mersen A70QS35-4
CFW900B26P0T2			1100	35	000	FNH000-40K-A	13737107	80	Mersen A70QS80-4
CFW900B34P0T2			1100	40	000	FNH000-50K-A	13737128	80	Mersen A70QS80-4
CFW900B45P0T2			1100	60	000	FNH000-63K-A	13737129	80	Mersen A70QS80-4
CFW900C56P0T2			65	Yes ⁽¹⁾⁽²⁾	1700	80	00	FNH00-80K-A	10705995
CFW900C70P0T2	3850	100			00	FNH00-100K-A	10707110	150	Mersen A70QS150-4
CFW900C80P0T2	3850	100			00	FNH00-125K-A	10707231	150	Mersen A70QS150-4
CFW900D0110T2	Yes ⁽¹⁾⁽²⁾	16200		125	00	FNH00-200K-A	10710732	250	Mersen A70QS250-4
CFW900D0135T2		25313		200	00	FNH00-250K-A	10711445	250	Mersen A70QS250-4
CFW900D0150T2	Yes ⁽¹⁾	25313		200	1	FNH1-250K-A	10809489	250	Mersen A70QS250-4
CFW900E0172T2		101250		250	1	FNH1-350K-A	10814896	400	Mersen A70QS400-4
CFW900E0195T2		101250		300	1	FNH1-350K-A	10814896	400	Mersen A70QS400-4
CFW900E0250T2		101250		300	2	FNH2-400K-A	10824053	400	Mersen A70QS400-4
CFW900A02P8T4	5 without panel 65 with panel ⁽¹⁾	Depends on the maximum short-circuit current of the grid		300	15	000	FNH000-20K-A	13735555	35
CFW900A03P6T4			300	15	000	FNH000-20K-A	13735555	35	Mersen A70QS35-4
CFW900A04P8T4			300	15	000	FNH000-20K-A	13735555	35	Mersen A70QS35-4
CFW900A06P5T4			300	15	000	FNH000-20K-A	13735555	35	Mersen A70QS35-4
CFW900A09P6T4			300	15	000	FNH000-20K-A	13735555	35	Mersen A70QS35-4
CFW900A14P0T4			685	20	000	FNH000-25K-A	13735656	35	Mersen A70QS35-4
CFW900A17P0T4			685	25	000	FNH000-35K-A	13737105	35	Mersen A70QS35-4
CFW900B26P0T4			685	35	000	FNH000-40K-A	13737107	80	Mersen A70QS80-4
CFW900B33P0T4			685	40	00	FNH00-50K-A	10701718	80	Mersen A70QS80-4
CFW900B39P0T4			1100	60	00	FNH00-63K-A	10705764	80	Mersen A70QS80-4
CFW900C50P0T4	65	Yes ⁽¹⁾⁽²⁾	1100	60	00	FNH00-63K-A	10705764	150	Mersen A70QS150-4
CFW900C62P0T4			3850	80	00	FNH00-80K-A	10705995	150	Mersen A70QS150-4
CFW900C74P0T4			9800	100	00	FNH00-125K-A	10707231	150	Mersen A70QS150-4
CFW900D96P0T4		Yes ⁽¹⁾⁽²⁾	16200	125	00	FNH00-160K-A	10701724	250	Mersen A70QS250-4
CFW900D0124T4			25313	150	00	FNH00-200K-A	10710732	250	Mersen A70QS250-4
CFW900D0146T4		Yes ⁽¹⁾	25313	200	1	FNH1-250K-A	10809489	250	Mersen A70QS250-4
CFW900E0172T4			101250	250	1	FNH1-350K-A	10814896	400	Mersen A70QS400-4
CFW900E0203T4			101250	250	1	FNH1-350K-A	10814896	400	Mersen A70QS400-4
CFW900E0242T4			101250	300	2	FNH2-400K-A	10824053	400	Mersen A70QS400-4

⁽¹⁾ Minimum panel dimensions for a grid short-circuit current capacity of 65 kA (see Table 3.7):

Frames A and B: 500x600x500 mm

Frame C: 500x800x600 mm

Frame D: 500x1000x500 mm

Frame E: 600x1000x600 mm

⁽²⁾ For the use of frames C and D drives in grids with a short-circuit current capacity of up to 10 kA there is no minimum panel size.

Table 3.6: Fuse specifications as per UL standard

Model	Maximum Short-Circuit Current of the Power Supply [kA]	Panel	Protection with	Protection with High Speed Fuses			
			Type J Fuses	AC Power Supply		DC Power Supply	
			Fuse Rated Current [A]	Fuse Rated Current [A]	Fuse Recommendation	Fuse Rated Current [A]	Fuse Recommendation
CFW900A04P6B2	5	No	Any type J ≤ 40 A	-	-	35	Mersen A70QS35-4
CFW900A06P0B2				-	-	35	Mersen A70QS35-4
CFW900A07P5B2				-	-	35	Mersen A70QS35-4
CFW900A10P0B2				-	-	35	Mersen A70QS35-4
CFW900A04P6T2				-	-	35	Mersen A70QS35-4
CFW900A06P0T2				-	-	35	Mersen A70QS35-4
CFW900A07P5T2				-	-	35	Mersen A70QS35-4
CFW900A10P6T2				-	-	35	Mersen A70QS35-4
CFW900A13P0T2				-	-	35	Mersen A70QS35-4
CFW900A19P0T2				-	-	35	Mersen A70QS35-4
CFW900B26P0T2				-	-	80	Mersen A70QS80-4
CFW900B34P0T2				-	-	80	Mersen A70QS80-4
CFW900B45P0T2				-	-	80	Mersen A70QS80-4
CFW900C56P0T2	10	Yes ⁽¹⁾	-	80	Mersen A100P80-4	150	Mersen A70QS150-4
CFW900C70P0T2			-	100	Mersen A100P100-4	150	Mersen A70QS150-4
CFW900C80P0T2			-	150	Mersen A100P150-4	150	Mersen A70QS150-4
CFW900D0110T2		Yes ⁽¹⁾	-	125	Mersen A100P125-4	250	Mersen A70QS250-4
CFW900D0135T2			-	200	Mersen A100P200-4	250	Mersen A70QS250-4
CFW900D0150T2			-	250	Mersen A100P250-4	250	Mersen A70QS250-4
CFW900E0172T2		Yes ⁽²⁾	Any type J ≤ 450 A	-	-	400	Mersen A70QS400-4
CFW900E0195T2				-	-	400	Mersen A70QS400-4
CFW900E0250T2				-	-	400	Mersen A70QS400-4
CFW900A02P8T4		5	No	Any type J ≤ 40 A	-	-	35
CFW900A03P6T4	-				-	35	Mersen A70QS35-4
CFW900A04P8T4	-				-	35	Mersen A70QS35-4
CFW900A06P5T4	-				-	35	Mersen A70QS35-4
CFW900A09P6T4	-				-	35	Mersen A70QS35-4
CFW900A14P0T4	-				-	35	Mersen A70QS35-4
CFW900A17P0T4	-				-	35	Mersen A70QS35-4
CFW900B26P0T4	-				-	80	Mersen A70QS80-4
CFW900B33P0T4	-				-	80	Mersen A70QS80-4
CFW900B39P0T4	-				-	80	Mersen A70QS80-4
CFW900C50P0T4	10	Yes ⁽¹⁾	-	60	Mersen A100P60-4	150	Mersen A70QS150-4
CFW900C62P0T4			-	80	Mersen A100P80-4	150	Mersen A70QS150-4
CFW900C74P0T4			-	150	Mersen A100P150-4	150	Mersen A70QS150-4
CFW900D96P0T4		Yes ⁽¹⁾	-	125	Mersen A100P125-4	250	Mersen A70QS250-4
CFW900D0124T4			-	150	Mersen A100P150-4	250	Mersen A70QS250-4
CFW900D0146T4			-	250	Mersen A100P250-4	250	Mersen A70QS250-4
CFW900E0172T4		Yes ⁽²⁾	Any type J ≤ 450 A	-	-	400	Mersen A70QS400-4
CFW900E0203T4				-	-	400	Mersen A70QS400-4
CFW900E0242T4				-	-	400	Mersen A70QS400-4

(1) Panel with a minimum size of 1.5 times the size of the inverter.

(2) Minimum panel dimensions (width x height x depth): 600x1000x600 mm (23.6x39.3x23.6 in).

Table 3.7: Circuit breaker specifications as per UL and IEC standards

Model	Circuit Breaker Protection				Minimum Panel Dimensions (Width x Height x Depth) [mm (in)]
	Maximum Short-Circuit Current of the Power Supply [kA]	Maximum Circuit Breaker Rated Current [A]	Weg Circuit Breaker recommendation		
			UL (CB type)	IEC (ACW type)	
CFW900A04P6B2	65	15	UBW225H-FTU15-3A	ACW100H-FMU20-3	500x600x500 (19.7x23.6x19.7)
CFW900A06P0B2		20	UBW225H-FTU20-3A	ACW100H-FMU20-3	
CFW900A07P5B2		30	UBW225H-FTU30-3A	ACW100H-FMU25-3	
CFW900A10P0B2		40	UBW225H-FTU40-3A	ACW100H-FMU40-3	
CFW900A04P6T2		15	UBW225H-FTU15-3A	ACW100H-FMU20-3	
CFW900A06P0T2		20	UBW225H-FTU20-3A	ACW100H-FMU20-3	
CFW900A07P5T2		30	UBW225H-FTU30-3A	ACW100H-FMU25-3	
CFW900A10P6T2		40	UBW225H-FTU40-3A	ACW100H-FMU40-3	
CFW900A13P0T2		50	UBW225H-FTU50-3A	ACW100H-FMU50-3	
CFW900A19P0T2		70	UBW225H-FTU70-3A	ACW100H-FMU63-3	
CFW900B26P0T2		100	UBW225H-FTU100-3A	ACW100H-FMU100-3	
CFW900B34P0T2		125	UBW225H-FTU125-3A	ACW160H-FMU125-3	
CFW900B45P0T2		150	UBW225H-FTU150-3A	ACW160H-FMU160-3	
CFW900C56P0T2		200	UBW225H-FTU200-3A	ACW250H-ATU200-3	600x800x500 (23.6x31.5x19.7)
CFW900C70P0T2		250	UBW250H-FTU250-3A	ACW250H-ATU250-3	
CFW900C80P0T2		300	UBW400H-FTU300-3A	ACW250H-ATU250-3	
CFW900D0110T2		300	UBW400H-FTU300-3A	ACW250H-ATU250-3	500x1000x500 (19.7x39.3x19.7)
CFW900D0135T2		400	UBW400H-FTU400-3A	ACW400H-ETS400-3	
CFW900D0150T2		400	UBW400H-FTU400-3A	ACW400H-ETS400-3	
CFW900E0172T2		500	UBW600H-FTU500-3A	ACW400H-ETS400-3	600x1000x600 (23.6x39.3x23.6)
CFW900E0195T2		500	UBW600H-FTU500-3A	ACW400H-ETS400-3	
CFW900E0250T2		600	UBW600H-FTU600-3A	ACW630H-ETS630-3	
CFW900A02P8T4		15	UBW225H-FTU15-3A	ACW100H-FMU20-3	500x600x500 (19.7x23.6x19.7)
CFW900A03P6T4		15	UBW225H-FTU15-3A	ACW100H-FMU20-3	
CFW900A04P8T4		15	UBW225H-FTU15-3A	ACW100H-FMU20-3	
CFW900A06P5T4		20	UBW225H-FTU20-3A	ACW100H-FMU25-3	
CFW900A09P6T4		30	UBW225H-FTU30-3A	ACW100H-FMU32-3	
CFW900A14P0T4		50	UBW225H-FTU50-3A	ACW100H-FMU50-3	
CFW900A17P0T4		60	UBW225H-FTU60-3A	ACW100H-FMU63-3	
CFW900B26P0T4		100	UBW225H-FTU100-3A	ACW100H-FMU100-3	
CFW900B33P0T4		125	UBW225H-FTU125-3A	ACW160H-FMU125-3	
CFW900B39P0T4		150	UBW225H-FTU150-3A	ACW160H-FMU125-3	
CFW900C50P0T4	200	UBW225H-FTU200-3A	ACW250H-ATU200-3	500x800x600 (19.7x31.5x23.6)	
CFW900C62P0T4	225	UBW225H-FTU225-3A	ACW250H-ATU200-3		
CFW900C74P0T4	250	UBW250H-FTU250-3A	ACW250H-ATU250-3		
CFW900D96P0T4	300	UBW400H-FTU300-3A	ACW250H-ATU250-3	500x1000x500 (19.7x39.3x19.7)	
CFW900D0124T4	300	UBW400H-FTU300-3A	ACW250H-ATU250-3		
CFW900D0146T4	400	UBW400H-FTU400-3A	ACW400H-ETS400-3	600x1000x600 (23.6x39.3x23.6)	
CFW900E0172T4	500	UBW600H-FTU500-3A	ACW400H-ETS400-3		
CFW900E0203T4	600	UBW600H-FTU600-3A	ACW400H-ETS400-3		
CFW900E0242T4	600	UBW600H-FTU600-3A	ACW630H-ETS630-3		

3.2.3.1 Pre-charge Circuit Control Fuses

- Frame E contains three fuses to protect the control circuit, located on the FPC90E board.
- The location of the FPC90E board is shown in [Figure 3.11](#).
- In case replacement is required, use control fuses as specified below or equivalent:
 - 0.5 A / 600 V time-delay fuse.
 - Manufacturer: Cooper Bussmann.
 - Commercial reference: FNQ-R-1/2.
 - WEG Item (material number): 10411493.

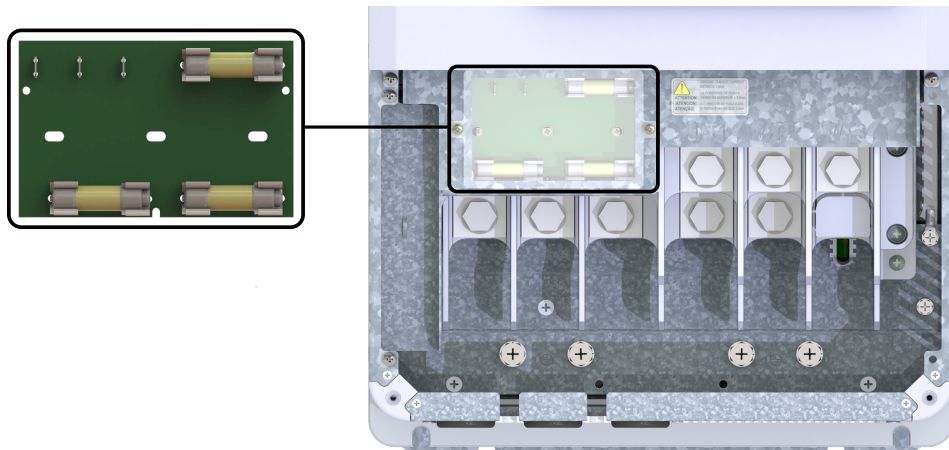

Figure 3.11: Fuses for the control circuit

3.2.4 Power Connections

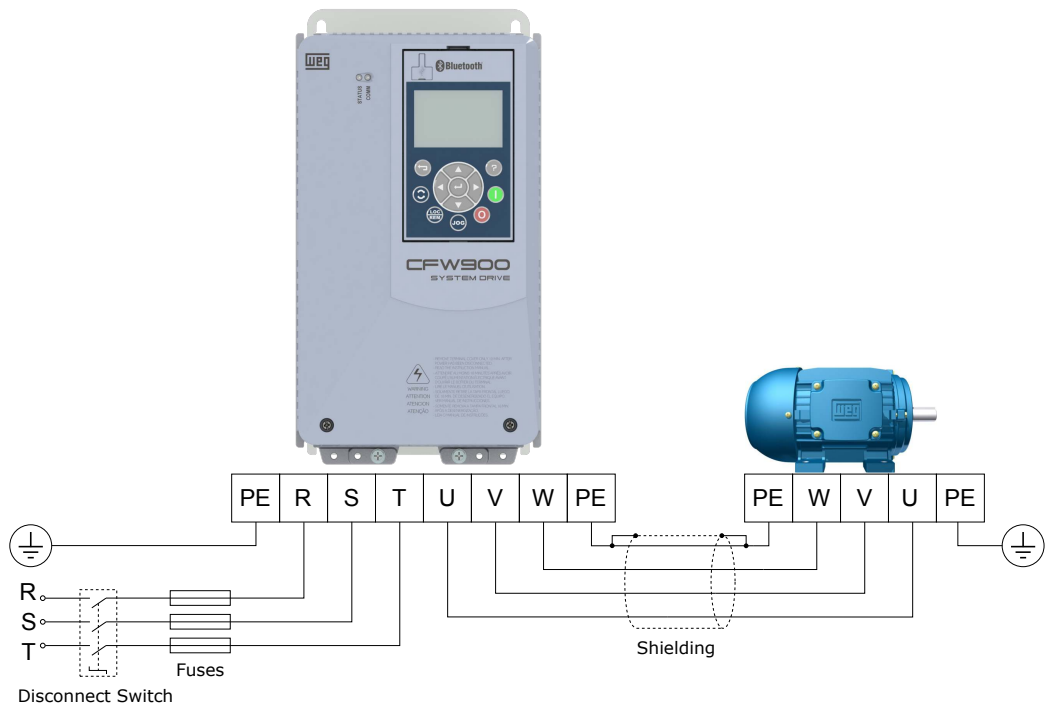





Figure 3.12: Power and grounding connections



DANGER!
Provide a disconnect device for the power supply of the inverter. This device must disconnect the power supply whenever necessary (during maintenance jobs, for instance).



WARNING!
A contactor or another device that frequently disconnects and reapplies the AC supply to the inverter, in order to start and stop the motor, may cause damage to the inverter power section. Use control signals to start and stop the motor. If used, the device in the input cannot exceed one operation per minute or the inverter may be damaged.



NOTE!

- The power supply voltage shall be compatible with the inverter rated voltage.
- Power factor correction capacitors are not needed at the inverter input (R/L1, S/L2, T/L3) and shall not be installed at the output of the inverter (U, V, W).



WARNING!
Residual current device (RCD):

- When used in the inverter supply, it must have a pick-up current of 300 mA.
- Depending on the installation (motor cable length, cable type, multimotor configuration, etc.), the RCD protection may be activated. Contact the RCD manufacturer for selecting the most appropriate device to be used with inverters.

Consider the following items for the use of protection devices on the supply side of the inverter such as residual current devices or isolation monitors:

- The detection of a phase-to-ground short-circuit or an insulation fault shall be processed by the user, i.e., the user shall decide whether to indicate the fault and/or block the inverter operation or both.
- Contact the RCD manufacturer for selecting the most appropriate device to be used with inverters in order to avoid nuisance tripping due to the high frequency leakage currents that flow through the leakage capacitances of the inverter, cable, and motor system to the ground.

3.2.4.1 IT and Delta Corner Earthed Networks



WARNING!

- The inverters of the CFW900 line can operate in power supply with a solidly grounded neutral, in delta corner earthed networks and IT networks (ungrounded neutral or grounding by a high ohmic value resistor). Exception: inverters of frame A cannot operate in delta corner earthed networks and resistor-grounded IT networks.
- To operate in delta corner earthed networks and IT networks, it is necessary to disconnect the RFI filter.
- Independent of the type of power grid, the inverter must always be connected to protective ground according to the [item 3.2.5](#).

Inverters of the CFW900 series can be used in IT networks with grounding made by resistors (except models of frame A). To that end, remove the grounding screws from the filter capacitors, as shown in [Figure 3.13](#). To access these screws on frames A, B, C and D, remove the HMI and the front cover. In frame E, it is necessary to remove the lower front cover.

It is also possible to operate the CFW900 in delta corner earthed networks, except for models of frame A. In these cases, the grounding screws of the filter capacitors must also be removed, as shown in [Figure 3.13](#).

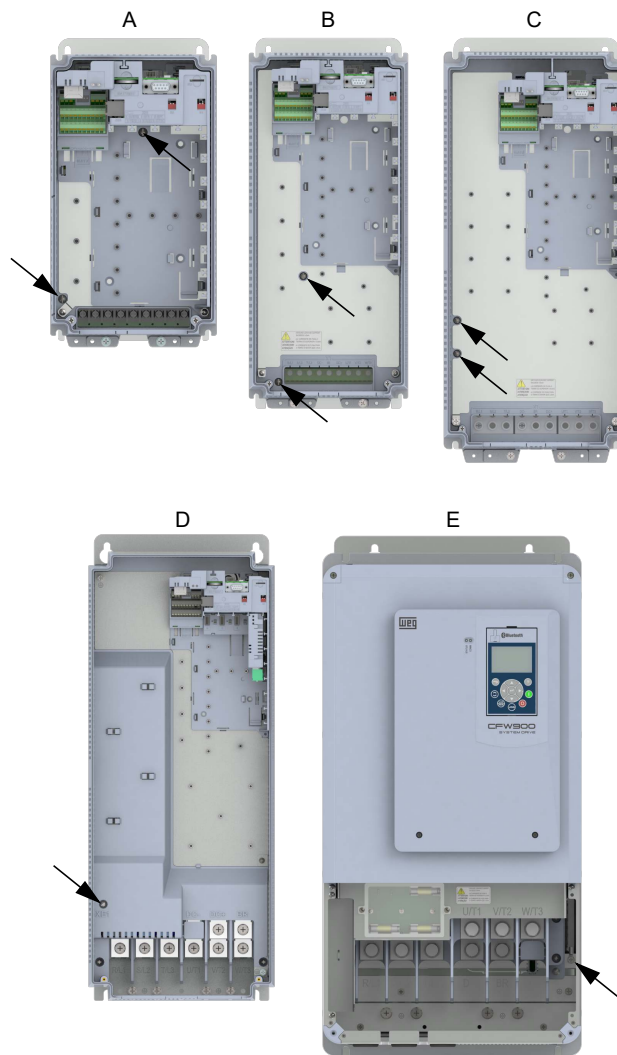

Figure 3.13: Grounding screws for filter capacitors and varistors

3.2.4.2 Dynamic Braking



NOTE!

All models of frames A, B, C, D and E with fixed suffix DB have internal braking IGBT, which is available in the standard version of frames A, B and C and as an optional item in frames D and E.

The braking torque that can be obtained from the frequency inverter without braking resistors varies from 10 % to 35% of the motor rated torque.

Braking resistors shall be used to obtain higher braking torques. In this case, the energy regenerated in excess is dissipated in a resistor mounted externally to the inverter.

This type of braking is used in cases where short deceleration times are desired or when high inertia loads are driven.

The “Optimal Braking” feature may be used with the vector control mode, which eliminates in most cases the need of an external braking resistor.

3.2.4.2.1 Sizing the Braking Resistor

The following application data shall be considered for the adequate sizing of the braking resistor:

- Desired deceleration time.
- Load inertia.
- Braking duty cycle.

In any case, the effective current value and the maximum braking current value presented in [Table 3.8](#) shall be respected.

The maximum braking current defines the minimum braking resistor value in ohms.

The DC Link voltage level for the activation of the dynamic braking function is defined in parameter C3.6.1 (DC link level).

The power of the braking resistor is a function of the deceleration time, the load inertia, and the load torque.

For most applications, a braking resistor with the value in ohms indicated in [Table 3.8](#), with the power of 20% of the rated driven motor power. Use wire type resistors in a ceramic support with adequate insulation voltage and capable of with standing high instantaneous power with respect to rated power. For critical applications with very short deceleration times and high inertia loads (ex.: centrifuges) or short duration cycles, consult WEG for the adequate sizing of the braking resistor.

Table 3.8: Dynamic braking specifications

Inverter Model	Maximum Braking Current (Imax) [A]	Maximum Braking Power (peak value) (Pmax) ⁽²⁾ [kW]	Effective Braking Current (Ieffective) ⁽¹⁾ [A]	Power (average) Dissipated in the Braking Resistor (PR) ⁽²⁾ [kW]	Recommended Resistor ⁽³⁾ [Ω]
CFW900A04P5B2	15	6	11	3	27
CFW900A06P0B2	15	6	11	3	27
CFW900A07P3B2	20	8	14	4	20
CFW900A10P0B2	50	20	36	10	8
CFW900A04P5T2	10	4	7	2	40
CFW900A06P0T2	10	4	7	2	40
CFW900A07P3T2	15	6	11	3	27
CFW900A10P0T2	30	12	22	6	13
CFW900A13P0T2	30	12	22	6	13
CFW900A19P0T2	50	20	36	10	8
CFW900B26P0T2	50	20	36	10	8
CFW900B34P0T2	50	20	36	10	8
CFW900B45P0T2	50	20	36	10	8
CFW900C56P0T2	75	30	54	15	5
CFW900C70P0T2	100	40	72	21	4
CFW900C80P0T2	100	40	72	21	4
CFW900D0110T2DB	243	97	174	50	2
CFW900D0135T2DB	243	97	174	50	2
CFW900D0150T2DB	243	97	174	50	2
CFW900E0195T2DB	400	160	287	82	1
CFW900E0250T2DB	400	160	287	82	1
CFW900A02P7T4	10	8	5	2	80
CFW900A04P6T4	10	8	5	2	80
CFW900A06P3T4	10	8	5	2	80
CFW900A09P6T4	15	12	8	1	53
CFW900A14P0T4	25	20	13	5	32
CFW900A17P0T4	35	28	18	7	22
CFW900B26P0T4	25	20	13	5	32
CFW900B33P0T4	25	20	13	5	32
CFW900B39P0T4	75	60	38	16	11
CFW900C49P0T4	75	60	38	16	11
CFW900C60P0T4	75	60	38	16	11
CFW900C70P0T4	150	120	77	32	5
CFW900D90P0T4DB	243	194	124	51	3
CFW900D0123T4DB	243	194	124	51	3
CFW900D0146T4DB	243	194	124	51	3
CFW900E0200T4DB	400	320	205	84	2
CFW900E0240T4DB	400	320	205	84	2

⁽¹⁾ The effective braking current shown is just a reference value, as it depends on the braking duty cycle. The effective braking current can be determined using the formula below, where t_{br} is given in minutes and corresponds to the sum of all braking periods during the severest cycle of five (5) minutes.

$$I_{eficaz} = I_{max} \cdot \sqrt{\frac{t_{br}}{5}}$$

⁽²⁾ The values of P_{max} and P_R (maximum and average power of the braking resistor, respectively) are valid for the recommended resistors and for the effective braking currents contained in Table 3.8. The resistor power changes according to the braking duty cycle.

⁽³⁾ For terminal specifications (screw and tightening torque) and recommended terminal types to connect the braking resistor (terminals DC+ and BR), see Table 3.4. Inverters with frame C contain plastic parts in front of the DC-, DC+ and BR terminals, which should be removed to access the terminals.

3.2.4.2.2 Installation of the Braking Resistor

To use a braking resistor, it is necessary to carry out the following procedures:

- Install the braking resistor between the power terminals DC+ and BR.
- Use twisted cable for the connection. Separate these cables from the signal and control cables.
- Size the cables according to the application, respecting the maximum and effective currents.
- If the braking resistor is installed inside the inverter cabinet, consider its additional dissipated energy when sizing

the cabinet ventilation.

DANGER!

The inverter has an adjustable thermal protection for the braking resistor. The braking transistor and resistor can be damaged if parameters C3.6.1 (Voltage Level DC Bus) e C3.6.4 (Hysteresis Level) are not set correctly or if the input voltage exceeds the maximum permissible value.

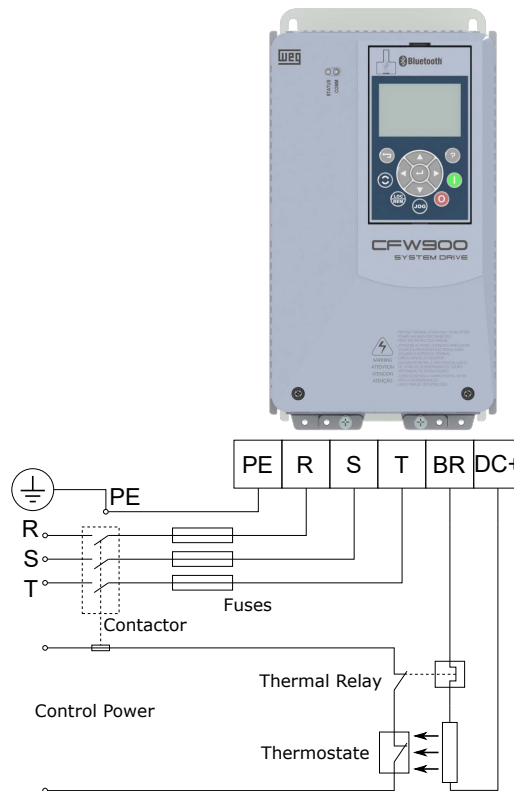

Figure 3.14: Braking resistor connection

NOTE!

DC current flows through the thermal relay bimetal strip during braking.

3.2.4.3 Output Connections

WARNING!

The inverter has an electronic motor overload protection that shall be adjusted according to the driven motor. When several motors are connected to the same inverter, install individual overload relays for each motor.

WARNING!

The motor overload protection available in the CFW900 is in accordance with the IEC609047-4-2 and UL61800-5-1, standards, note the following information:

- “Trip” current equal to 1.25 times the motor rated current (C2.1.5) adjusted in the Oriented “Start-up” menu.
- The maximum value of parameter C7.4.6 (Motor Thermal Class) is 3 (class 20).
- The maximum value for C2.1.11 (Motor service factor) is 1.15.
- The maximum value of the overload current parameters C7.4.3, C7.4.4 and C7.4.5 is 100%.

WARNING!

If a disconnect switch or a contactor is installed between the inverter and the motor, never operate them with a spinning motor or with voltage at the inverter output.

The characteristics of the cable used to connect the motor to the inverter, as well as its interconnection and routing, are extremely important to avoid electromagnetic interference in other equipment and not to affect the life cycle of windings and bearings of the controlled motors.

Keep motor cables away from other cables, such as signal cables, control cables, etc.), according to [Table 3.9](#).

Table 3.9: Cable separation distance

Cable length	Minimum separation distance
≤ 30 m	≥ 10 cm
> 30 m	≥ 25 cm

3.2.4.3.1 Motor cables

Unshielded cables:

- Can be used when it is not necessary to meet the European directive of electromagnetic compatibility (IEC 61800-3).
- The emission of the cables may be reduced by installing them inside a metal conduit, which shall be grounded at both ends.
- It is necessary to connect a fourth cable between the motor ground and the inverter ground.

NOTE!

The magnetic field created by the current circulation in these cables may induce current in close metal pieces, heat them, and cause additional electrical losses. Therefore, keep the 3 (three) cables (U, V, W) always together.

Shielded cables:

- They are mandatory when it is necessary to comply with the electromagnetic compatibility standard, as defined by IEC 61800-3 standard “Adjustable Speed Electrical Power Drive Systems”.
- These cables act mainly by reducing the irradiated emission in the radio-frequency range.
- In reference to the type and details of installation, follow the recommendations of IEC 60034-25 “Guide For Design and Performance of Cage Induction Motors Specifically Designed For Converter Supply”, refer to a summary in [Figure 3.15](#). Refer to the standard for further details and eventual modifications related to new revisions.
- The grounding system shall be well interconnected among the several installation locations such as the grounding points of the motor and the inverter. Voltage difference or impedance between the several points may cause the circulation of leakage currents among the equipment connected to the ground, resulting in electromagnetic interference problems.

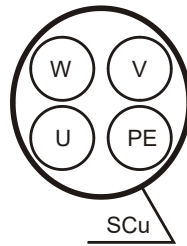

(a) Symmetrical shielded cables: three concentric conductors with or without a ground conductor, symmetrically manufactured, with an external shield of copper or aluminum

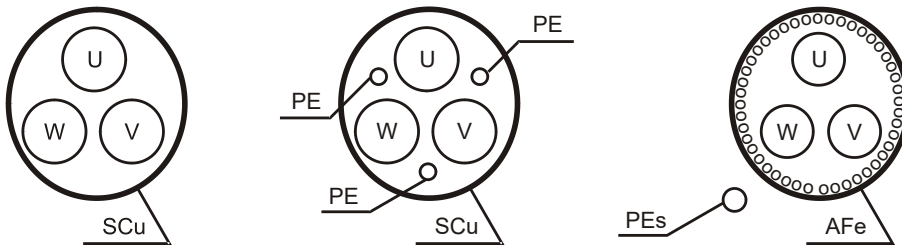

(b) Alternative for conductors up to 10 mm²

SCu = copper or aluminum external shielding.

AFe = steel or galvanized iron.

PE = ground conductor.

Note 1: Cable shielding shall be grounded at both ends (inverter and motor). Use 360° connections for a low impedance to high-frequencies. Refer to [Figure 3.16](#).

Note 2: For using the shield as a protective ground, it shall have at least 50% of the power cables conductivity. Otherwise, add an external ground conductor and use the shield as an EMC protection.

Note 3: Shielding conductivity at high-frequencies shall be at least 10% of the power cables conductivity.

Figure 3.15: Motor connection cables recommended by IEC 60034-25

3.2.4.3.2 Connection of the Motor Cable Shield to Ground

Inverters of the CFW900 series include clamps and grounding plates that simplify the connection of the control cables and motor cable shield, enabling a low impedance connection for high frequencies. [Figure 3.16](#) shows an example of motor cable connection using these materials in an inverter with IP2X protection rating. The connection on inverters with UL type 1 protection rating is similar.



Figure 3.16: Detail of the motor cable shield connection

3.2.5 Grounding Connections

DANGER!

- The inverter must be obligatorily connected to a protective ground (PE).
- Use grounding wiring with a gauge at least equal to that indicated in [Table 3.4](#).
- Connect the grounding points of the inverter to a specific grounding rod, or specific grounding point, or to the general grounding point (resistance $\leq 10 \Omega$).
- To comply with IEC 61800-5-1 standard, connect the inverter to the ground by using a single conductor copper cable with a minimum wire gauge of 10 mm² or a two-conductor cable with the same wire gauge of the grounding cable specified in [Table 3.4](#) since the leakage current is greater than 3.5 mA AC.

DANGER!

Do not share the grounding wiring with other equipment that operate with high currents (ex.: high power motors, soldering machines, etc.). When installing several inverters, follow the procedures presented in [Figure 3.18](#) for the grounding connection.

WARNING!

The neutral conductor of the network that powers the inverter cannot be used to ground the inverter.



Figure 3.17: Grounding terminals

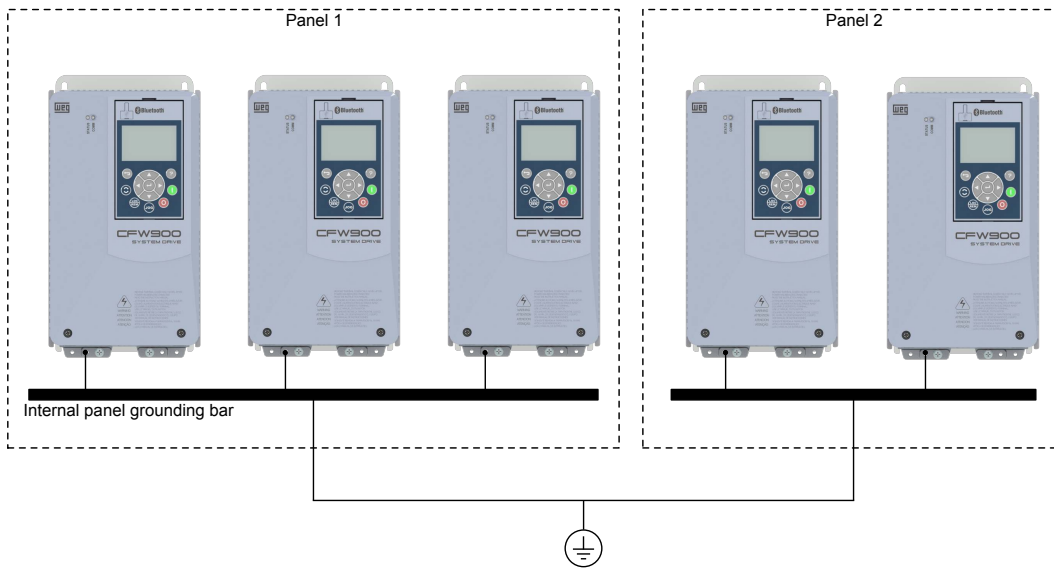

Figure 3.18: Grounding connections with multiple inverters

3.2.6 Control Connections

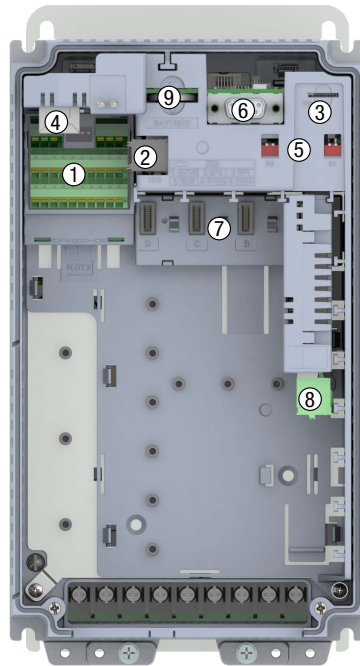

Figure 3.19: CFW900 control connections

Table 3.10: Description of control connections

Item	Description
1	XC1 Connector (CFW900-IOS): digital and analog inputs and outputs, input for external power supply and RS-485 communication
2	XC2 Connector (safety module): STO and SS1-t functions
3	XC3 connector (microSD card slot): allows copying parameters and storing SoftPLC programs (see the programming manual)
4	XC4A and XC4B connectors: dual port ethernet connection (RJ45) (see the ethernet communication manual)
5	DIP switches S1 and S2: safety module configuration
6	XC6 connector: DB9 connector for connecting the HMI/remote HMI
7	Backplane CFW900-4SLOTS: provides four slots to connect accessories. By default, slot A is taken by the CFW900-REL-01. It can be replaced by the CFW900-7SLOTS, which has seven slots for accessories
8	XC30 (CFW900-REL-01): Relay output
9	CR2032 battery for real time clock. Use non-conductive pliers or tweezers to remove/replace the battery



(a) Inputs configured in PNP mode (standard version)

(b) Inputs configured in NPN mode
Figure 3.20: (a) and (b) Connection examples on XC1 (CFW900-IOS)

Table 3.11: XC1 connector (CFW900-IOS)

Connector XC1		Description ⁽¹⁾	Default Function (if any)
Pin	Name		
1	AO1	Analog Output 1	Speed
2	AO2	Analog Output 2	Motor current
3,8,18,26	GND	Control circuit reference	
4	C	RS-485 interface reference	
5	A(-)	RS-485 interface negative	
6	B(+)	RS-485 interface positive	
7	VIN	+24 Vdc external power supply input	
9,25	VOUT	+24 Vdc power supply output	
10	DI1	Digital input 1	Run/Stop (Only in remote mode 2)
11	DI2	Digital input 2	
12	DI3	Digital input 3	
13	DI4	Digital input 4	
14	DI5	Digital input 5	Input A for encoder
15	DI6	Digital input 6	Input B for encoder
16	COM	Common of the digital inputs	
17	10V	10V power supply for potentiometer	
19	AI1+	Differential analog input 1	Speed reference (only in remote mode 2)
20	AI1-		
21	AI2+	Differential analog input 2	
22	AI2-		
23	DO1	Digital output 1	
24	DO2	Digital output 2	

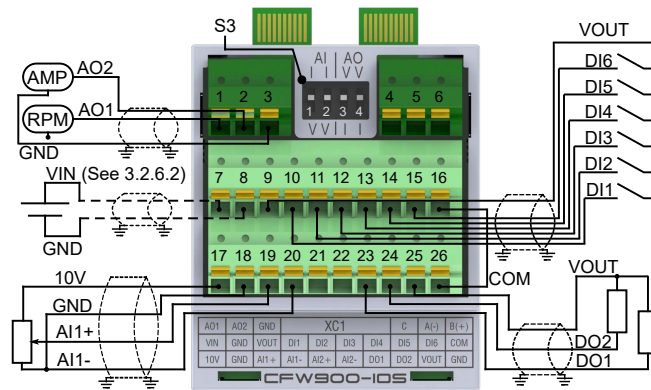
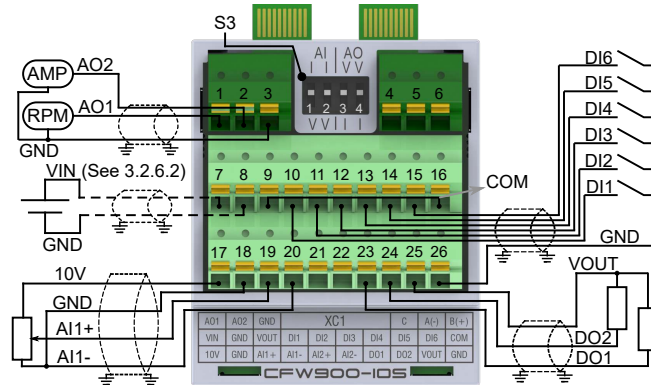
⁽¹⁾ For more information see the detailed specification in Table 8.11.

NOTE!

The digital outputs of the CFW900-IOS have freewheeling diodes for the 24 Vdc power supply of the inverter control (inverter internal power supply or external power supply connected to VIN). If a separate external 24 Vdc power supply is used to power the loads of the digital outputs, the state of the outputs will remain indeterminate as long as the 24 V power supply of the inverter control is not energized. If this characteristic is unwanted, the CFW900-REL-01 or CFW900-IOD-01 outputs must be used.

Table 3.12: Configuration of DIP switches for selecting the type of signal on the CFW900-IOS analog inputs/outputs

Input/Output	DIP switch	DIP position: Selected mode ⁽¹⁾	Factory Default
AI1	S3:1	V: -10 a 10V; I: 4 a 20mA / 0 a 20 mA	V
AI2	S3:2	V: -10 a 10V; I: 4 a 20mA / 0 a 20 mA	V
AO1	S3:3	V: 0 a 10V; I: 4 a 20mA / 0 a 20 mA	V
AO2	S3:4	V: 0 a 10V; I: 4 a 20mA / 0 a 20 mA	V

⁽¹⁾ The parameters referring to the inputs/outputs also need to be configured. Refer to the programming manual.

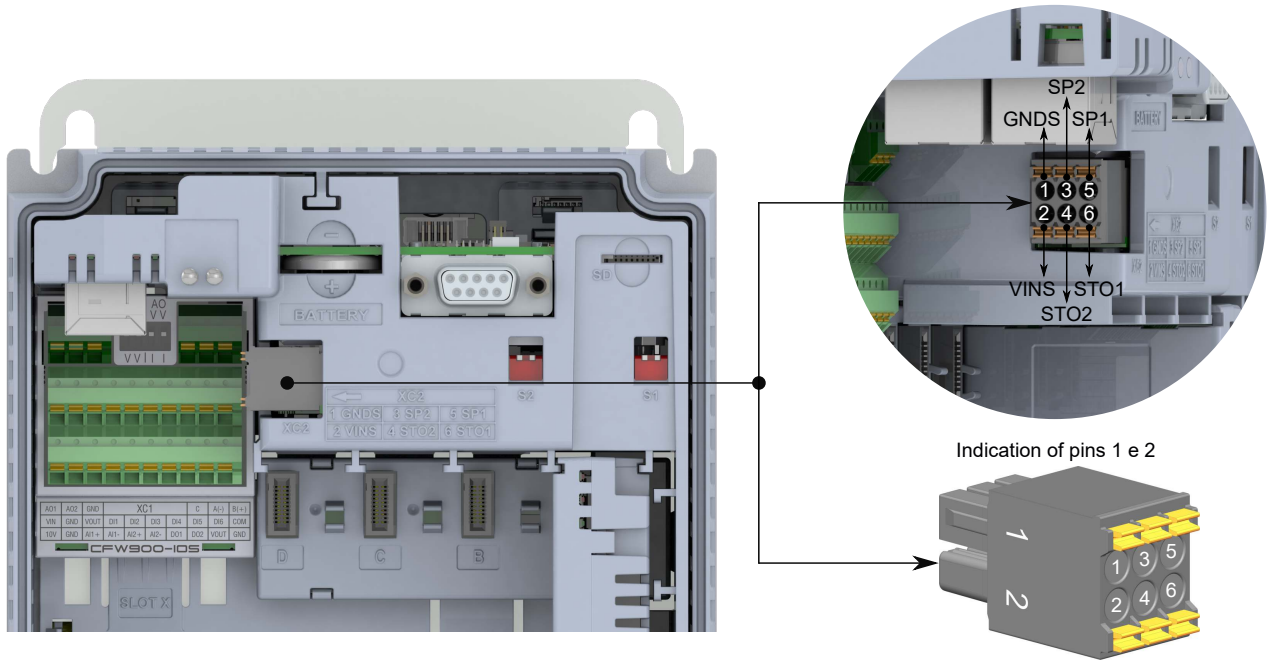

Figure 3.21: XC2 connector location and pinout

Table 3.13: XC2 connector (safety module)

XC2 connector		Description: ⁽¹⁾
Pin	Name	
1	GNDS	Safety module reference
2	VINS	+24 Vdc power supply for the safety module
3	SP2	Safety signal for STO2 input
4	STO2	Safety input 2
5	SP1	Safety signal for STO1 input
6	STO1	Safety input 1

⁽¹⁾ For more information and connection examples, refer to the CFW900 safety manual.

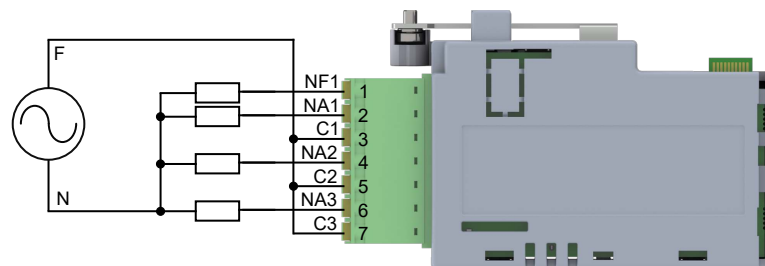

Figure 3.22: CFW900-REL-01 XC30 connector pinout with example of AC load connection

Table 3.14: XC30 connector (CFW900-REL-01 Accessory)

XC30 connector		Description: Default Function (if any) ⁽¹⁾
Pin	Name	
1	NF1	1A Digital Relay Output: No fault ⁽²⁾
2	NA1	NO: Normally Open, C: Common, NC: Normally closed
3	C1	
4	NA2	2A Digital Relay Output: ⁽²⁾
5	C2	N>Nx (S2.1.1 > C5.9.4)
6	NA3	3A Digital Relay Output ⁽²⁾
7	C3	N*>Nx (S2.1.3 > C5.9.4)

⁽¹⁾ For more information see the detailed specification in Table 8.13.

⁽²⁾ The CFW900-REL-01 supplied with the inverter will be connected to slot A, and the corresponding outputs will be 1A, 2A and 3A, with the default functions indicated. If the accessory is reconnected to another slot, the identification of the outputs will change to 1n, 2n and 3n, with 'n' being the slot where the accessory was connected.

WARNING!

For protection against electric shock, the CFW900-REL-01 provides reinforced isolation between the relay output contacts and other control circuits. Isolation between outputs is basic in accordance with IEC61800-5-1 and UL61800-5-1 with voltage limits of 60 Vdc/25 Vac. In order to comply with IEC and UL standards, user-accessible circuits and circuits with voltage above 60 Vdc/25 Vac must not be activated in the same CFW900-REL-01.

For the correct installation of the control wiring:

- Use cable gauge according to [Table 3.15](#).
- Use shielded cables for control inputs/outputs and communication networks. When the cable is longer than 30 m, ground the shield at both ends.
- Correctly ground the shield of the cables, using the shield connection in 360°, as shown in [Figure 3.23](#).
- Keep the control, communication and remote HMI cables separate from the other cables (input and motor cables, 110/220 Vac control etc.) according to Table 3.9. If the those cables have to cross the other cables, it must be done perpendicularly, keeping the minimum separation distance of 5 cm at the crossing point.
- Relays, contactors, solenoids or electromechanical braking coils installed close to the inverters may generate interference in the control circuit. To eliminate this effect, RC suppressors must be connected in parallel to the coils of those devices in case of AC power supply, and freewheeling diodes in case of DC power supply.

Table 3.15: Cable gauges for control connection

Conector	Conductor gauge without terminal		Conductor gauge with wire ferrule and insulation		Stripping or terminal length (mm)
	Minimum mm ² (AWG)	Maximum mm ² (AWG)	Minimum mm ² (AWG)	Maximum mm ² (AWG)	
XC1	0.2 (24)	1.5 (16)	0.25 (23)	1.5 (16)	10 mm
XC2	0.2 (24)	1.5 (16)	0.12 (26)	0.75 (18)	10 mm
XC30	0.2 (24)	2.5 (12)	0.25 (23)	2.5 (12)	8 mm

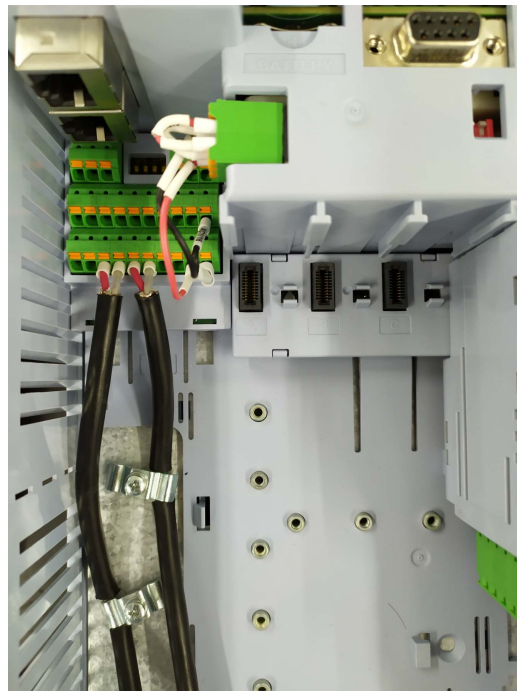

Figure 3.23: Connection example of control cable shield

3.2.6.1 Internal 24 Vdc Power Supply Current Capacity

The inverters of the CFW900 line have an internal 24 Vdc / 0.8 A power supply used to power the accessories connected to slots A to G. The current capacity not used by the accessories can be used to power external

circuits, such as sensors, digital inputs, loads on digital outputs, etc. via the VOUT output of XC1. In applications that use multiple accessories, it may be necessary to use an external 24 Vdc power supply.

Follow the next steps to evaluate the consumption of the internal power supply and calculate the current available in VOUT:

1. Check the consumption of the accessories that will be installed in each backplane slot through [Table 7.2](#);
2. Add the consumption of each accessory to be connected to slots A to G using the equation:

$$I_{ACC} = I_{ACC,A} + I_{ACC,B} + I_{ACC,C} + I_{ACC,D} + I_{ACC,E} + I_{ACC,F} + I_{ACC,G}$$
 to obtain the total consumption of the accessories;
3. Check the total current consumed by the accessories:
 - If the current drawn by the accessories is greater than 0.8 A, (i.e., $I_{ACC} > 0,8 \text{ A}$) it will be necessary to use an external power supply. Check item [3.2.6.2](#);
 - If the consumption of the accessories is less than or equal to 0.8 A (i.e., $I_{ACC} \leq 0,8 \text{ A}$), the remaining current can be consumed through the VOUT outputs. Go to item 4 to check the current available in VOUT;
4. Calculate the maximum current in VOUT: $I_{OUT} = 0,8 \text{ A} - I_{ACC}$;
5. Check that the circuits to be connected to the VOUT output do not exceed the calculated maximum current I_{OUT} .

Table 3.16: Examples of how to check the consumption of the internal power supply and current available in VOUT

Ex.	Accessory ⁽²⁾	SLOT A	SLOT B	SLOT C	SLOT D	SLOT E	SLOT F	SLOT G	I_{ACC}	I_{OUT}
1	Model	REL-01							0.05 A	0.75 A
	Consumption	0.05 A								
2	Model	REL-01	TEMP-01	CCAN-W	ENC-01				0.30 A	0.50 A
	Consumption	0.05 A	0.05 A	0.00 A	0.20 A					
3	Model	REL-01	TEMP-01	CCAN-W	ENC-01	IOAI-01	IOD-01	IOD-01	0.40 A	0.40 A
	Consumption	0.05 A	0.05 A	0.00 A	0.20 A	0.10 A	0.00 A	0.00 A		
4	Model	REL-01	TEMP-01	ENC-01	ENC-01	IOAI-01	IOAI-01	IOAI-01	0.80 A	0.00 A
	Consumption	0.05 A	0.05 A	0.20 A	0.20 A	0.10 A	0.10 A	0.10 A		
5 ⁽¹⁾	Model	ENC-01	ENC-01	IOAI-01	IOAI-01	IOAI-01	IOAI-01	IOAI-01	0.90 A	-0.10 A ⁽¹⁾
	Consumption	0.20 A	0.20 A	0.10 A	0.10 A	0.10 A	0.10 A	0.10 A		

⁽¹⁾ In this example, the capacity of the internal power supply was exceeded, being necessary to use an external power supply as [3.2.6.2](#).

⁽²⁾ Prefix "CFW900" has been omitted.



NOTE!

If it is necessary to use an external power supply because the consumption of accessories and loads connected to VOUT is greater than 0.8 A, make sure that the external power supply is energized before or at the same time as the inverter, and that the inverter is de-energized before or together with the external power supply.

3.2.6.2 Use of a 24 Vdc External Power Supply

The external power supply operates redundantly with the inverter internal power supply and allows the control, communication and accessory circuits to remain active (powered and responding to commands) even with the power circuit de-energized.

The inverter indicates the "Poff" state when the control power is active and there is no voltage on the inverter DC link. The use of the external power supply is also necessary if the total current drawn by the accessories is greater than the capacity of the inverter internal power supply, as explained in item [3.2.6.1](#).

When the external power supply is energized, the inverter control circuits, accessories and loads connected to the VOUT output of XC1 draw current from the external power supply. This way the loads in VOUT will also have redundant power.

Follow the next steps to size the external power supply:

1. Check the consumption of the accessories that will be installed in each backplane slot through [Table 7.2](#);
2. Add the consumption of each accessory to be connected to slots A to G using the equation:

$$I_{ACC} = I_{ACC,A} + I_{ACC,B} + I_{ACC,C} + I_{ACC,D} + I_{ACC,E} + I_{ACC,F} + I_{ACC,G}$$
, to obtain the total consumption of the accessories;
3. Calculate I_{OUT} , which is the total consumption of the circuits to be connected to VOUT. Even with an external power supply, a maximum of 0.8 A can be drawn from VOUT without tripping the internal overcurrent protection;
4. Size the minimum current capacity of the external power supply using the equation: $I_{FE} = 0,5 A + I_{ACC} + I_{OUT}$;
5. Use an external 24 Vdc \pm 10 % power supply with a current capacity of at least I_{FE} . The external power supply must be connected to the terminals VIN and GND of [XC1](#);
6. Check if the internal power supply is also able to feed the necessary current to the accessories and loads connected to VOUT, i.e., $I_{OUT} + I_{ACC} \leq 0,8 A$. If not, ensure that the external power supply will be energized before or together with the inverter power-up, and that the inverter will be de-energized before the external power supply.

Table 3.17: Examples of how to check the consumption of the external power supply and current available in VOUT

Ex.	Accessory ⁽²⁾	SLOT A	SLOT B	SLOT C	SLOT D	SLOT E	SLOT F	SLOT G	I_{ACC}	I_{OUT}	I_{FE}
1	Model	REL-01							0.05 A	0.1 A	0.65 A
	Consumption	0.05 A									
2 ⁽¹⁾	Model	REL-01	TEMP-01	CCAN-W	ENC-01				0.30 A	0.80 A	1.60 A
	Consumption	0.05 A	0.05 A	0.00 A	0.20 A						
3	Model	REL-01	TEMP-01	CCAN-W	ENC-01	IOAI-01	IOD-01	IOD-01	0.40 A	0.40 A	1.30 A
	Consumption	0.05 A	0.05 A	0.00 A	0.20 A	0.10 A	0.00 A	0.00 A			
4 ⁽¹⁾	Model	REL-01	TEMP-01	ENC-01	ENC-01	IOAI-01	IOAI-01	IOAI-01	0.80 A	0.10 A	1.40 A
	Consumption	0.05 A	0.05 A	0.20 A	0.20 A	0.10 A	0.10 A	0.10 A			
5 ⁽¹⁾	Model	ENC-01	ENC-01	IOAI-01	IOAI-01	IOAI-01	IOAI-01	IOAI-01	0.90 A	0.50 A	1.90 A
	Consumption	0.20 A	0.20 A	0.10 A	0.10 A	0.10 A	0.10 A	0.10 A			

⁽¹⁾ In these examples, the capacity of the internal power supply has been exceeded, and care must be taken to ensure that the external power supply is energized before the inverter.

⁽²⁾ Prefix "CFW900" has been omitted.

3.3 INSTALLATION ACCORDING TO THE EUROPEAN DIRECTIVE OF ELECTROMAGNETIC COMPATIBILITY

Inverters with suffix C3 have an internal RFI filter to reduce electromagnetic interference. These inverters, when installed in accordance with the instructions contained in this manual, meet the requirements of the electromagnetic compatibility directive “EMC Directive 2004/108/EC”.

The CFW900 inverter series has been designed only for industrial applications. Therefore, the emission limits of harmonic currents defined by the standards EN 61000-3-2 and EN 61000-3-2/A 14.



WARNING!

- For the CFW900 line operating in IT networks (ungrounded neutral or grounding by a high ohmic value resistor) or delta corner earthed networks, it is necessary to disconnect the grounding screws, as explained in [item 3.2.4.1](#). for internal damage to the inverter will occur. In these cases, the inverter falls into category C4 according to IEC/EN 61800-3.

3.3.1 Standard Definitions

Definitions of IEC/EN 61800-3 Standard: "Adjustable Speed Electrical Power Drives Systems"

■ Environment:

First Environment: includes domestic premises. It also includes establishments directly connected without intermediate transformer to a low-voltage power supply network which supplies buildings used for domestic purposes.

Second Environment: includes all establishments other than those directly connected to a low-voltage power supply which supplies buildings used for domestic purposes.

■ Categories:

Category C1: inverters with a voltage rating less than 1000 V and intended for use in the First Environment.

Category C2: inverters with a voltage rating less than 1000 V, intended for use in the First Environment, not provided with a plug connector or a movable installations, and installed and commissioned by a professional.

Category C3: inverters with a voltage rating less than 1000 V and intended for use in the Second Environment only (not designed for use in the First Environment).

Category C4: inverters with a voltage rating equal to or greater than 1000 V, or with a current rating equal to or greater than 400 Amps, or intended for use in complex systems in the Second Environment.

Definitions of EN 55011 Standard: "Threshold values and measuring methods for radio interference from industrial, scientific and medical (ISM) high-frequency equipment"

Class B: equipment intended for use in the low voltage power supply (condominiums, commerce and light industry).

Class A1: equipment intended for use in the low voltage power supply. Restricted distribution.

Note: it must be installed and commissioned by a professional when applied in low voltage power supply.

Class A2: equipment intended for use in industrial environments.



NOTE!

A professional is a person or organization familiar with the installation and/or commissioning of inverters, including their EMC aspects.

3.3.2 Conformal Installation

For conformal installation, you must:

1. For TT/TN supply networks, keep the internal RFI filter connected.
2. Shielded output cables (motor cables) with the shield connected on both sides, motor and inverter, with low impedance connection for high frequency; for example, see [Figure 3.23](#). Keep the separation from the other cables according to Table 3.9. For more information see [item 3.2.4](#). Maximum motor cable length and conducted and radiated emission levels according to [Table 3.18](#).
3. Ground the inverter as explained in [item 3.2.5](#).
4. Use shielded control cables and keep the separation from the other cables according to [Item 3.2.6](#).
5. Design or choose the panel considering the applicable measures to comply with the EMC standards. If an extension is made inside the panel for connecting the power, motor and ground cables (that is, if these cables are not directly connected to the inverter terminals), the panel must be designed so as to have a low impedance connection for high frequencies. In this case, it is not necessary to use a shielded cable between the inverter UVW terminals and the connection points of the motor shielded connection cable; however, it is necessary to provide a way to ground the cable shield with a 360° connection in a similar way to the one found in the inverter cable grounding kit supplied with the inverter.

3.3.3 Emission and Immunity Levels Met

Table 3.18: Emission and immunity levels

EMC PHENOMENON	LEVEL	BASIC STANDARD
Emission		
Mains terminal disturbance voltage Frequency range: 150 kHz to 30 MHz	Category C2: maximum 10 m cable in TT/TN networks ⁽¹⁾⁽²⁾ Category C3: maximum 200 m cable in TT/TN networks Category C4: IT or delta earthed networks	IEC/EN 61800-3:2017
Electromagnetic radiation disturbance Frequency range: 30 MHz to 1 GHz 1.4 GHz to 2.7 GHz	Category C3 in TT/TN networks (All frame D models require a panel with minimum attenuation of 10dB to comply with the C3 category) Category C4: IT or delta earthed network	
Immunity		
Electrostatic discharge immunity test	4 kV for contact discharge and 8 kV for air discharge	IEC 61000-4-2
Electrical Fast Transient/Burst immunity test	2 kV/5 kHz (coupling capacitor) input cables, control cables and motor cable 1 kV/5 kHz (coupling capacitor) remote HMI cable	IEC 61000-4-4
Immunity to conducted disturbances induced by radio-frequency fields	0.15 to 80 MHz; 10 V; 80 % AM (1 kHz) Motor, control and remote HMI cables	IEC 61000-4-6
Surge immunity test	1.2/50 μs, 8/20 μs 1 kV input cables, line-to-line coupling 2 kV input cables, line-to-ground coupling 1 kV control cables, coupling to the cable shield, cable shield grounded at both ends	IEC 61000-4-5
Radiated, radio-frequency, electromagnetic field immunity test	8 a 1000 MHz 10 V/m 80 % AM (1 kHz)	IEC61000-4-3

⁽¹⁾ Use of toroid on power cables is required (Part Number T60006-L2045-V101-01- VACUUMSCHMELZE manufacturer or similar).











⁽²⁾ The models with frames C, D and E of line T2 and frame E of line T4 do not comply with the C2 category.

4 HMI

The product graphic HMI allows viewing and programming the CFW900 frequency inverter. The key navigation provides access to all data by means of groups (Menus).



Figure 4.1: HMI keys

-  USB connector for communication with PC.
-  “Esc”: Cancel programming or go back to menu.
-  “Help”: Shows help text for the marked content.
-  Increment and Decrement values. Navigate the menus.
-  Switch between screens. Move selection for editing values. Navigate the menus.
-  Enter key: Save changes. Enter the menus.
-  Control the motor direction of rotation if programmed for HMI.
-  Select LOCAL or REMOTE command if programmed for HMI.
-  Run JOG if programmed for HMI.
-  Stop motor if programmed for HMI or fault/protection reset.
-  Run motor if programmed for HMI.

All the HMI operation is based on menus, which contain the reading and writing variables. The menus are divided into levels, containing menus and submenus.

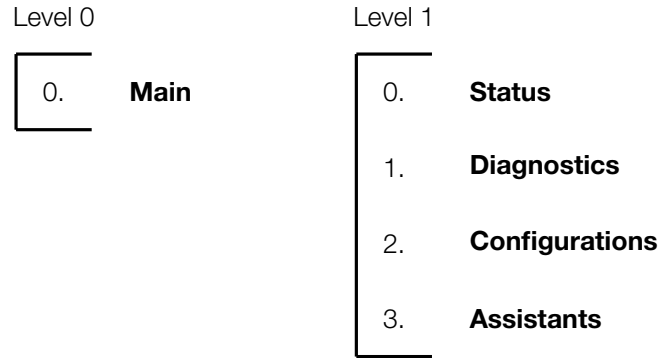

Figure 4.2: HMI Screens and Menus

Level 0:

The main screen is located, where you can select which reading variables (**Status**) you want to view.

Level 1:

The main menus to access the variables are located. These, in turn, are divided into reading variables (**Status** and **Diagnostics**), and writing or programming variables (**Configurations** and **Wizards**).



NOTE!

The **Status** parameters cannot be changed through the HMI. Some of these parameters may be a reading variable from a **Configuration** for a given communication network and thus can be changed using it.

4.1 MAIN SCREEN

After powering up the CFW900, the HMI starts up on the **Main** screen, where you can see some reading variables (**Status**).

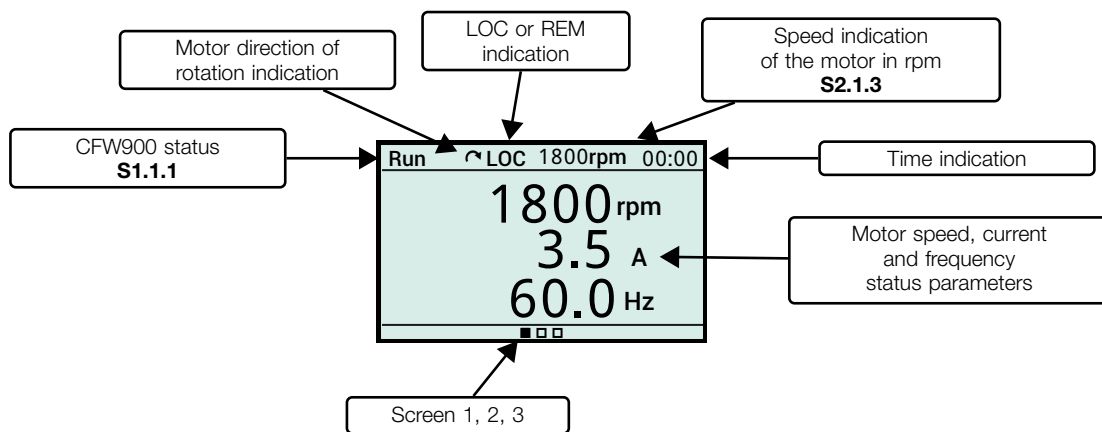

Figure 4.3: Main screen data

There are three main screens, which can be configured to display up to nine variables each. To customize these main screens, see the section 4.5 of this chapter.

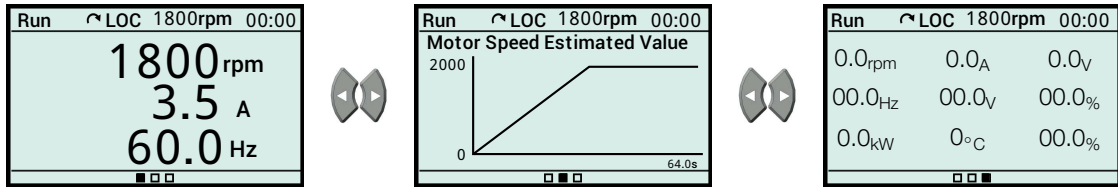

Figure 4.4: Default main screens

To access the menus, just press the "Enter" key.

4.2 MENU ACCESS MODE - MENU LEVELS

When you press the "Enter" key on a main screen, you access the menus. In the menu, it is possible to navigate the groups and subgroups to access the variables.

Each variable has its own coding, containing its location in the menu structure and its identification. Digits are separated by a period.

Example:

C2.1.4 = Motor rated voltage value

C2.1.4 = Configurations → Motor → Motor Data → Rated Voltage

Level 1	Level 2	Level 3	Level 4	Edition
C	C2	C2.1	C2.1.4	440V
Configurations	Motor	Motor Data	Rated Voltage	

4.2.1 Reading Variables - Status and Diagnostics Menus

All reading variables for the HMI are available in two main menus: **Status** and **Diagnostics**.

Status Menu: It has reading variables with updated values: current, voltage and others.

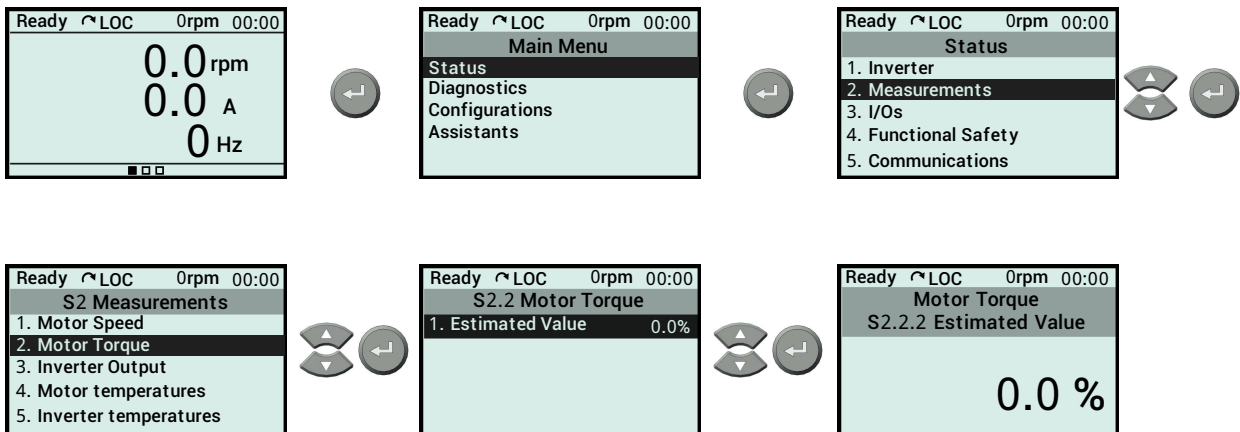

Figure 4.5: Average torque reading

Diagnostics Menu: It has reading variables with values saved as a result of events: actuation of protections, alarms, start and others.

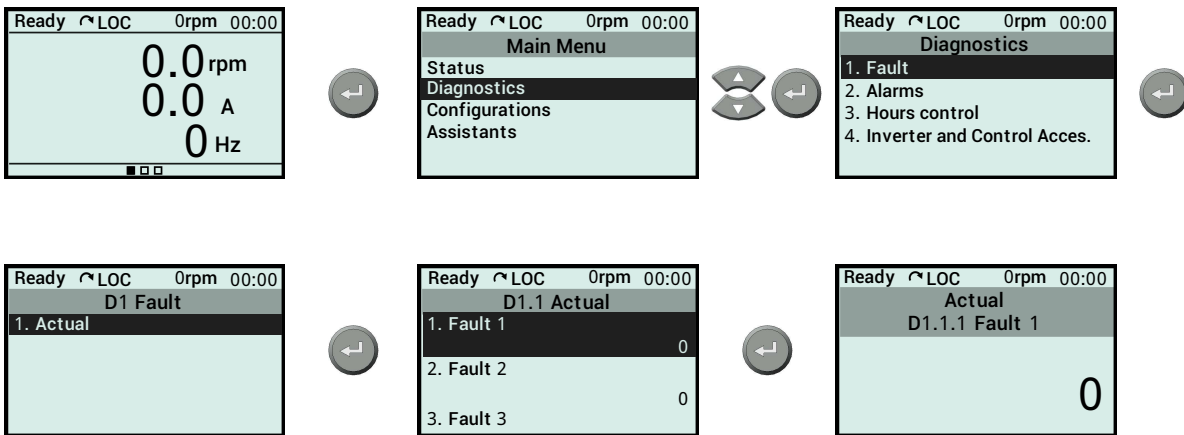

Figure 4.6: Reading of protection actuations

4.2.2 Writing Variables - Configurations Menu

All programming or configuration of the CFW900 is carried out through this menu, which is divided into programming submenus, groups or subgroups.

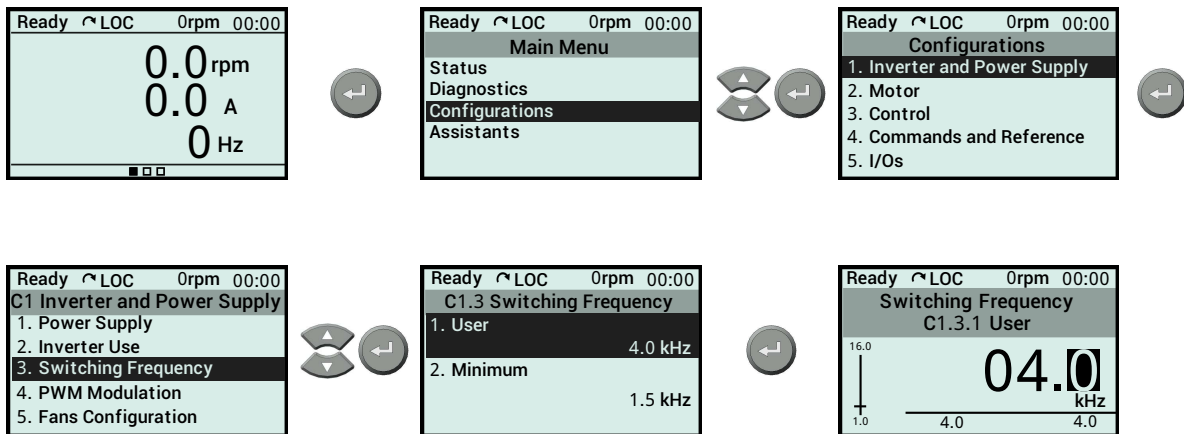

Figure 4.7: Switching frequency configuration

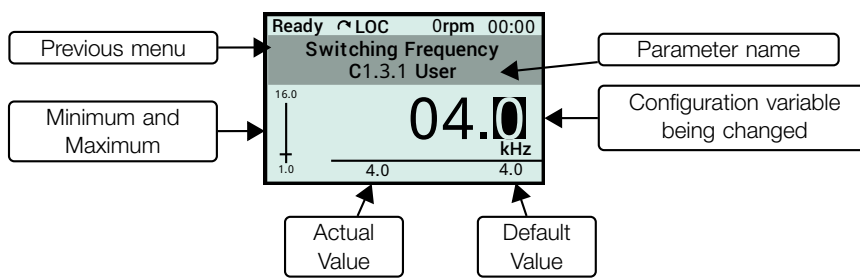

Figure 4.8: Configuration screen data

4.2.3 Writing Variables - Wizards Menu

The **Wizards** menu contains some of the most used settings arranged sequentially to facilitate the CFW900 start-up.

4.3 HELP KEY

Help key

The help key provides more information about the selected text. This key can be used at any time while navigating the menus, parameters or main screens. If, for example, the selected text is a parameter, when the help key is

pressed, a text about this parameter will be displayed; if it is pressed on a main screen, the coding of the parameters present in this screen will be displayed.

The figures below show some examples of the use of the help key.

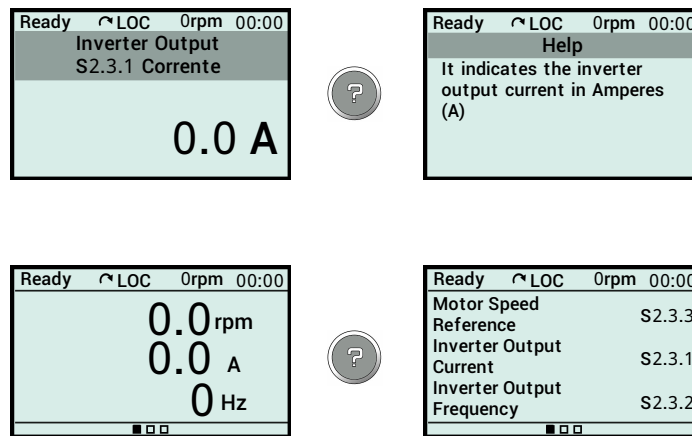

Figure 4.9: Example of the use of the help key

4.4 DATE AND TIME SETTING

Set the date and time in the configurations menu, as illustrated below.

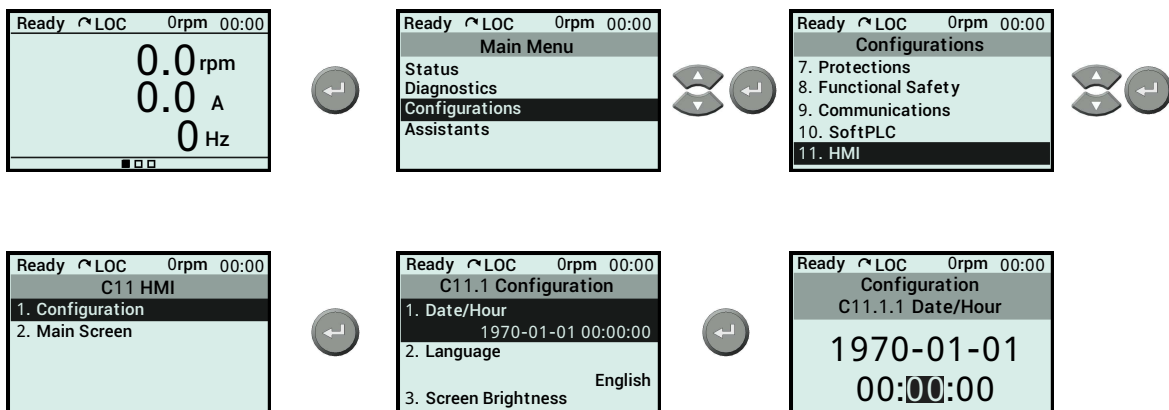

Figure 4.10: Date and time setting

4.5 MAIN SCREEN SETTING

Customizing the main screens allows you to define what will always be displayed when powering up the CFW900. Three easy-to-access main screens are available. Each screen can be configured among 3 view modes.

4.5.1 View Modes

- Line:** In one line, it is possible to display a reading variable in the format **text, value or bar**. Figure 4.11 shows an example with the three formats.

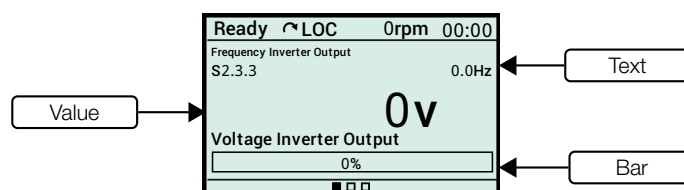

Figure 4.11: Inline View

- **Full screen:** It covers an entire main screen and allows viewing reading variables in the format **text, bar or graphic**. Figure 4.12 shows an example with the three formats.

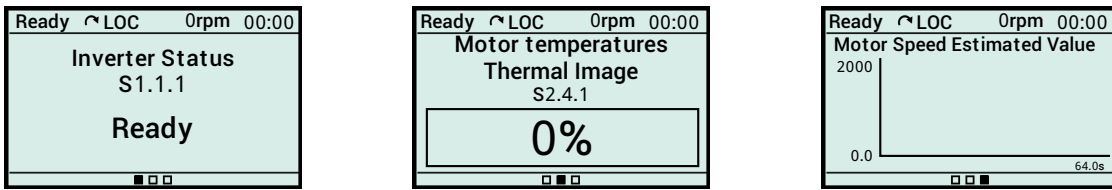

Figure 4.12: View in (a) text, (b) bar and (c) graphic

- **Slot:** The HMI screen is divided into nine parts called Slots and allows viewing reading variables in the format **value**. Figure 4.13 shows a view example.

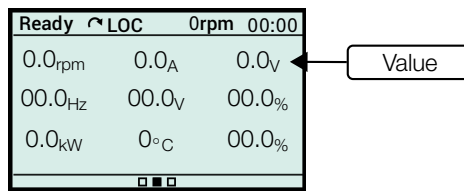

Figure 4.13: View in Slot

NOTE! The **Line** and **Slot** view modes can be merged if there is space in the line.

4.5.2 Modification of the Main Screen

The main screens can be modified following the following steps:

1. Go to the HMI main screen configuration menu (C11.2).

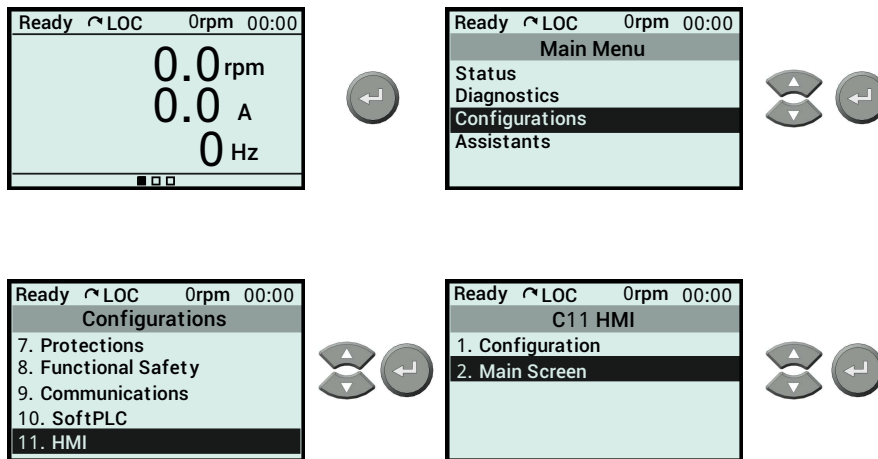

2. Select *Add View* and choose the reading variable to be added to the **Main** screen.

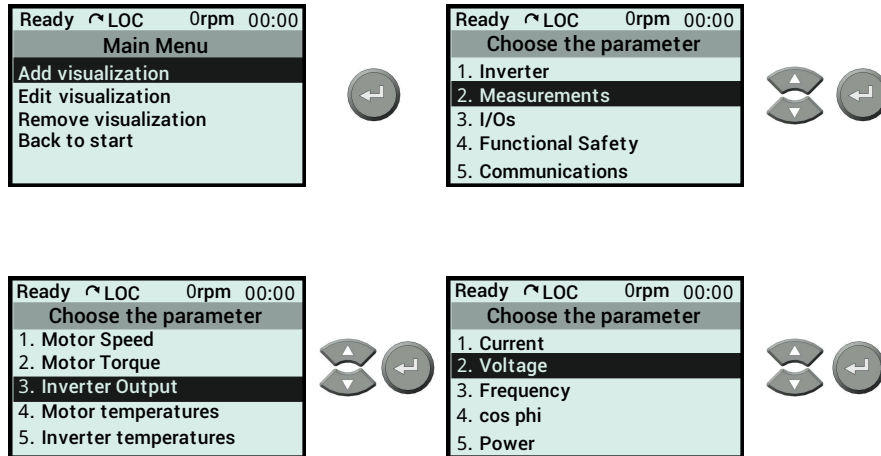

3. Then select the view format for the reading variable and its location on the main screens. In this example, the full screen mode in graphic format will be chosen. Use the navigation keys to switch between screens.

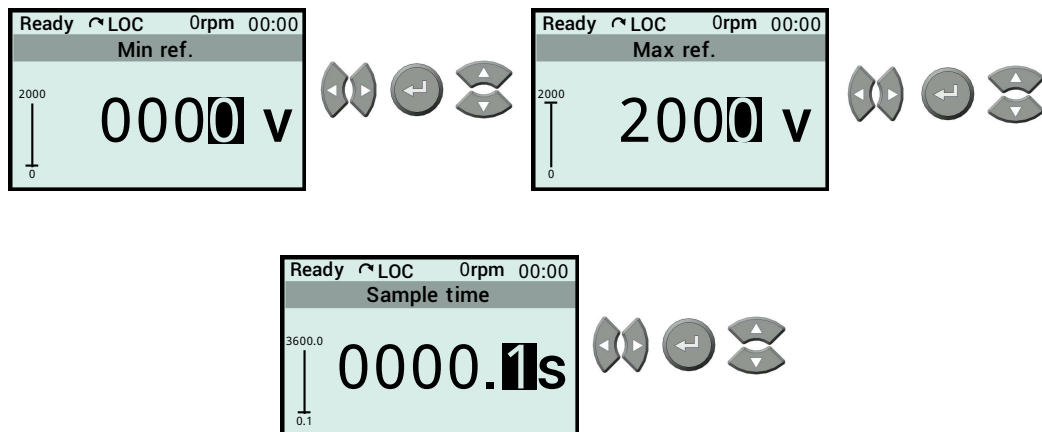

4. Configure the view format. For this example, choose the graph range and sampling rate.

NOTE!

The option *Edit View* is applied to the bar and graph mode, where you can set the minimum and maximum values for existing views.

5. Confirm the new view.

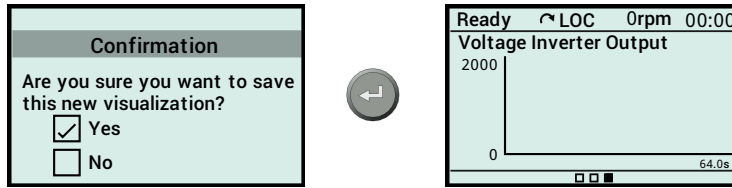

4.5.3 Screen Examples

Other screen examples are shown below:

Example 1

Figure 4.14 is an example of a main screen with parameter readings displayed in the **Slot** and **Line** mode, showing:

- in the first line, the temperatures of the motor stator windings in the **Slot** mode, **value** format;
- in the second line, the thermal image of the motor in the **Line** mode, **text** format;
- in the third line, the power internal air temperature in the **Line** mode, **bar** format.

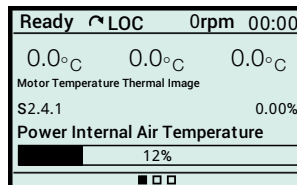

Figure 4.14: Main screen examples

Example 2

Figure 4.15 is an example of a **main screen** with parameter readings displayed in the **Line** mode, showing:

- in the first line, the inverter output current in the **Line**, mode **text** format;
- in the second line, the inverter output current in the **Line** mode, **text** format;
- in the third line, the inverter output power in the **Line** mode, **bar** format.

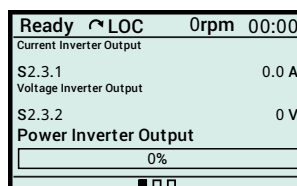

Figure 4.15: Main screen examples

4.6 USB MODE

The CFW900 HMI has a USB port to connect the inverter to a computer with WEG WPS software installed. This software application allows, among other things, reading variables, configuring parameters and updating the inverter firmware. For more details, see the WPS (WEG Programming Suite) manual, available at www.weg.net.

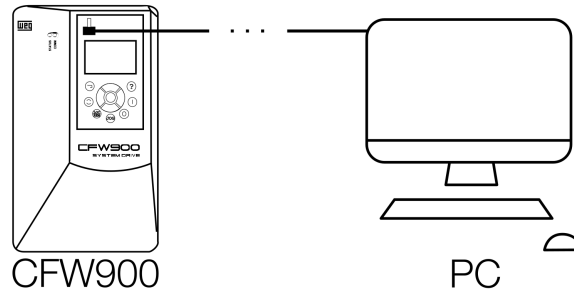

Figure 4.16: CFW900 USB connection to a computer

When the inverter is not powered or connected to an external 24 Vdc power supply, the control circuit is powered by the USB port, which imposes some restrictions. Only the control circuit will be enabled; other circuits, control accessories and networks will be disabled.

The USB power supply allows reading and writing parameters via HMI and connection to the WPS, but the parameters of connected accessories will not be available, as well as parameters linked to regulation functions (which depend on the operation of other parts of the inverter). Functions that use the MicroSD card will not be available either.



WARNING!

In the USB mode, the HMI cannot be used remotely. It must be directly connected to the inverter.



NOTE!

Once powered by the USB port, when making changes to the inverter parameters via HMI, wait for the confirmation screen to ensure the saving of the parameter.



NOTE!

If the inverter control circuit is powered by the USB, and another power supply is connected, the drive will reset.

4.7 INSTALLING THE HMI

- The HMI can be installed or removed with the inverter powered up or not.
- The HMI supplied with the product can also be used for remote command of the inverter. In this case, use a cable with D-Sub9 (DB-9) male and female connectors with pin-to-pin connections. It is recommended to use the M3 x 5.8 spacers supplied with the product. Recommended torque: 0.5 N.m (4.50 lbf.in).
- The HMI cables can be supplied as accessories, and the list of available items is in [Table 7.1](#).
- The maximum length of the HMI cables is specified in [Figure 8.10](#).

5 FIRST TIME POWER-UP AND START-UP

This chapter explains:

- Check and prepare the inverter before power-up.
- Power-up the inverter and check the result.
- Set the inverter for the operation in the V/f mode based on the power supply and motor information by using the Oriented Start-Up routine.



NOTE!

For instructions to use the inverter in the VVV and Vector mode or other existing functions, refer to the programming manual of the CFW900.

5.1 PREPARE FOR START-UP

Before power-up, the inverter must have already been installed according to the instructions of [Chapter 3](#).



DANGER!

Always disconnect the main power supply before performing any inverter connection.

1. Check if power, grounding, and control connections are correct and firmly secured.
2. Remove from the inside of the inverter all installation material left behind.
3. Check that the motor connections, voltage and current are according to the inverter.
4. Mechanically uncouple the motor from the load. If the motor cannot be uncoupled, make sure that the chosen direction of rotation (forward or reverse) will not result in personnel injury and/or equipment damage.
5. Return the inverter covers.
6. Measure the power supply and verify if it is within the allowed range, according to [Chapter 8](#).
7. Apply power to the input: close the input disconnect switch.
8. Check the result of the first time power-up: The keypad should display the standard monitoring mode [Figure 4.3](#) and the status LED should be steady green.

5.2 START-UP

1. Execution of the **Oriented Start-Up** routine via parameter A1.
2. Follow the menu steps.

5.3 INSTRUCTIONS FOR COMPUTER CONNECTION

**NOTE!**

- Always use shielded USB interconnect cable, “standard host/device shielded USB cable”. Unshielded cables may lead to communication errors.
- Recommended cables Samtec:
 - USBC-AM-MB-B-B-S-1 (1 meter).
 - USBC-AM-MB-B-B-S-2 (2 meters).
 - USBC-AM-MB-B-B-S-3 (3 meters).
- The USB connection is galvanically isolated from the mains power supply and from other high voltages internal to the inverter. However, the USB connection is not isolated from the protective ground (PE). Use an isolated notebook for the USB connection or a desktop connected to the same protective ground (PE) of the inverter.

To control the motor speed and to view and program the inverter through a PC, it is necessary to install the WEG WPS software, available at: "www.weg.net".

Basic procedure to transfer data from the PC to the inverter:

1. Install the WEG WPS software on your computer.
2. Connect the PC to the inverter via USB cable.
3. Start the WEG WPS.
4. Select “File → New Configuration” and follow the steps on the screen to make the connection.

For more details and other functions related to WEG WPS, including connection via RS-485 and Ethernet interfaces, refer to the WEG WPS manual.

6 TROUBLESHOOTING AND MAINTENANCE

This chapter explains:

- Check and prepare the inverter before power-up.
- Power-up the inverter and check the result.

6.1 OPERATION OF PROTECTIONS, FAULTS AND ALARMS

When a protection or fault actuates, the result is:

- The PWM pulses are blocked.
- Indication on the display of the fault/protection description and code.
- The STATUS “LED” starts flashing red.
- Deactivation of the digital outputs set for the function “without fault”.
- Activation of the digital outputs set for the function “with fault”.
- Writing of essential data to the inverter internal memory:
 - Speed references via HMI and Electronic Potentiometer if the “Speed backup” function is enabled.
 - Code of the protection, fault or alarm occurred.
 - Status of the motor overload function integrator.
 - Status of the hours enabled (D3.2) and energized (D3.1) counter.

For the inverter to return to normal operation right after the actuation of a protection or fault, it is necessary to reset it, which can be done as follows:

- Pressing the HMI red key (manual reset).
- Automatically by setting C7.9.1 (auto-reset).
- Via digital input set for reset.
- Switching off the power supply and switching it back on (power-on reset).

When an alarm actuates, the result is:

- Indication on the display of the alarm description and code.
- The STATUS “LED” changes to yellow.
- The PWM pulses are not blocked (the inverter is still operating).

6.2 PROTECTIONS, FAULTS, ALARMS, AND POSSIBLE CAUSES

The **Protections, Faults and Alarms** are a functionality of the CFW900 that allows viewing events, helping to troubleshoot and identifying improvements in the inverter parameter settings.

- Protections and faults disable the motor PWM pulses. The reason for their actuation is indicated on the HMI, in the CFW900 status word (S1.1.1) and in the current protection diagnosis (D1.1). This information is only cleared with a reset or by switching off the inverter.
- The alarms are indicated on the HMI, in the CFW900 status word (S1.1.1) and in the current alarm diagnosis (D2.1). They are automatically cleared after the alarm condition ceases.

The **Protections, Faults and Alarms** are presented to the user through codes preceded by the letters F for protection and failure and A for alarm, as shown in the [Section 6.3](#). In this section you also find more details about the causes and possible solutions.

NOTE!

Most protections and alarms can be solved by following the instructions contained in this chapter; otherwise, contact WEG's representative or technical support.

6.3 PROTECTION, FAULT AND ALARM TABLE

Protection/Alarm	Description	Possible causes
F006: Grid Unbal./Phase Loss	Unbalance or phase loss in the power supply. Note: - In case the motor has no load on the shaft or the load is low, this fault may not occur. - Actuation time set to C7.1.1. When C7.1.1=0, the fault is disabled.	- Phase loss at the inverter input. - Input voltage unbalance >5 %. - Loss of one phase in the power supply.
A010: Rectifier Overtemp.	Alarm of high temperature measured in the temperature sensors (NTC) of the rectifier modules. Note: - It can be disabled by changing the IGBT Overtemp. setting to fault only, in parameter C7.5.1.	- High ambient temperature around the inverter (>50 °C) and high output current. - Locked or defective fan. - Inverter heat sink too dirty.
F011: Rectifier Overtemp.	Fault of overtemperature measured in the temperature sensors (NTC) of the rectifier modules.	- High ambient temperature around the inverter (>50 °C) and high output current. - Locked or defective fan. - Inverter heat sink too dirty.
A018: Low Battery Voltage	Low battery voltage alarm.	- Replace the battery.
A019: 24Vdc Power Supply Overvoltage	24Vdc power supply overvoltage fault.	- Voltage of the 24 Vdc power supply that feeds the control above the maximum value of 27.4 V cc.
A020: 24Vdc Power Supply Undervoltage	24 Vdc power supply undervoltage fault.	- Voltage of the 24 Vdc power supply that feeds the control below the minimum value of 22.8 Vdc.

Protection/Alarm	Description	Possible causes
F021: DC Link Undervoltage	DC link undervoltage fault.	<ul style="list-style-type: none"> - Supply voltage too low, producing voltage on the DC link (S2.7.1) below the minimum value: Ud < 203 V - Supply voltage 200 V. Ud < 210 V - Supply voltage 208-240 V. Ud < 385 V - Supply voltage 380 V. Ud < 405 V - Supply voltage 400-415 V. Ud < 446 V - Supply voltage 440-460 V. Ud < 487 V - Supply voltage 480 V. Ud < 507 V - Supply voltage 500-525 V. Ud < 557 V - Supply voltage 550-600 V. Ud < 669 V - Supply voltage 660-690 V. - Phase loss at the input. - Fault on the pre-charge circuit. - Parameter C1.1.2 with a value above the rated line voltage.
F022: DC Link Overvoltage	DC link overvoltage fault.	<ul style="list-style-type: none"> - Supply voltage too high, producing voltage on the DC link (S2.7.1) above the maximum value: Ud > 400 V - Models 200-240 V. Ud > 800 V - Models 380-480 V. Ud > 1000 V - Models 500-600 V. Ud > 1200 V - Models 660-690 V. - Driven load inertia too high or deceleration ramp too fast. - C3.5.2.1 or C3.5.3.2 or C3.6.1 setting is too high.
F025: Pulse Feedback Error	Failure to compare the PWM pulses generated by the control and the output voltages measured by the inverter. Note: - Reset the inverter and try again.	<ul style="list-style-type: none"> - Motor is disconnected or motor is small in relation to the rated current of the inverter connected to the output. - Possible defect on the inverter internal circuits. - Problems in the circuit of the STO safety inputs (XC2).
F030: IGBT U Desat	Fault of desaturation on the IGBTs of arm U.	<ul style="list-style-type: none"> - Short circuit between the motor phases U and V or U and W.
F034: IGBT V Desat	Fault of desaturation on the IGBTs of arm V.	<ul style="list-style-type: none"> - Short circuit between the motor phases V and U or V and W.
F038: IGBT W Desat	Fault of desaturation on the IGBTs of arm W.	<ul style="list-style-type: none"> - Short circuit between the motor phases W and U or W and V.
F042: Brake IGBT Desat	Fault of desaturation on the dynamic braking IGBT.	<ul style="list-style-type: none"> - Short circuit on the connecting cables of the dynamic braking.
A046: High Load on the Motor	Motor overload alarm. Note: - It can be disabled by setting C7.4.1 = 0 or 2.	<ul style="list-style-type: none"> - C7.4.3, C7.4.4 and C7.4.5 setting is low for the motor used. - Overload on the motor shaft.
A047: High Load on the IGBTs	IGBT overload alarm.	<ul style="list-style-type: none"> - High current at the inverter output:
F048: Overload on the IGBTs	IGBT overload fault.	<ul style="list-style-type: none"> - Current at the inverter output is too high.
A050: IGBT1 U Overtemp.	Alarm of high temperature measured in the temperature sensors (NTC) of the IGBTs. Note: - It can be disabled by C7.5.1.	<ul style="list-style-type: none"> - High ambient temperature around the inverter (>50 °C) and high output current. - Locked or defective fan. - Inverter heat sink too dirty.

Protection/Alarm	Description	Possible causes
A051: IGBT1 V Overtemp.	Alarm of high temperature measured in the temperature sensors (NTC) of the IGBTs. Note: - It can be disabled by C7.5.1.	- High ambient temperature around the inverter (>50 °C) and high output current. - Locked or defective fan. - Inverter heat sink too dirty.
A052: IGBT1 W Overtemp.	Alarm of high temperature measured in the temperature sensors (NTC) of the IGBTs. Note: - It can be disabled by C7.5.1.	- High ambient temperature around the inverter (>50 °C) and high output current. - Locked or defective fan. - Inverter heat sink too dirty.
F053: IGBT1 U Overtemp.	Fault of overtemperature measured in the temperature sensors (NTC) of the IGBTs.	- High ambient temperature around the inverter (>50 °C) and high output current. - Locked or defective fan. - Inverter heat sink too dirty.
F054: IGBT1 V Overtemp.	Fault of overtemperature measured in the temperature sensors (NTC) of the IGBTs.	- High ambient temperature around the inverter (>50 °C) and high output current. - Locked or defective fan. - Inverter heat sink too dirty.
F055: IGBT1 W Overtemp.	Fault of overtemperature measured in the temperature sensors (NTC) of the IGBTs.	- High ambient temperature around the inverter (>50 °C) and high output current. - Locked or defective fan. - Inverter heat sink too dirty.
A060: IGBT/DRL Junction Overtemp.	High temperature at the junction of the IGBTs or diodes alarm.	- High ambient temperature around the inverter (>50 °C) and high output current. - Locked or defective fan. - Inverter heat sink too dirty.
F061: IGBT/DRL Junction Overtemp.	Overtemperature at the junction of the IGBTs or diodes fault.	- High ambient temperature around the inverter (>50 °C) and high output current. - Locked or defective fan. - Inverter heat sink too dirty.
F062: Thermal Imbalance	Power module temperature unbalance fault.	- The temperature difference between IGBT modules of the same phase (U, V, W) is above 15 °C. - The temperature difference between IGBT modules of different phases (U and V, U and W, V and W) is above 20 °C. - The temperature difference between rectifier modules of different phases (R and S, R and T, S and T) is above 20 °C.
F070: DC Link Short Circuit	Fault of short circuit at the output, DC link or braking resistor.	- Short circuit between two motor phases. - Short circuit on the connecting cables of the dynamic braking. - Short-circuited IGBT modules.
F071: Overcur. at the Output	Output overcurrent fault.	- Load inertia too high or acceleration ramp too fast. - C3.4.1 or C3.3.5.1.1 setting is too high.
F072: Motor Overload	Motor overload fault. Note: - The fault can be disabled by setting C7.4.1 = 0 or 3.	- C7.4.3, C7.4.4 and C7.4.5 setting too low for the motor. - Load on the motor shaft is too high.
F074: Ground Fault	Overcurrent to ground fault. Note: - The fault can be disabled by setting C7.2.1 = 0 or 3.	- Short circuit to the ground at one or more output phases. - Motor cable capacitance too high, causing current peaks at the output.

Protection/Alarm	Description	Possible causes
F078: Motor Overtemp.	Fault related to the PTC temperature sensor installed on the motor. Note: - The fault can be disabled by setting C7.5.2 = 2 or 3. - It is necessary to program Slot X analog input and output for PTC function.	- Load on the motor shaft is too high. - Load cycle is too short (high number of starts and stops per minute). High ambient temperature around the motor. - Poor contact or short circuit (resistance < 100 Ω) on the wiring connected to the motor thermistor. Motor thermistor not installed. - Motor shaft locked.
F080: CPU Fault (Watchdog)	Inverter control watchdog fault.	- Electrical noise.
F084: Self-Diagnostics. Error	Self-Diagnostics Fault.	- Defect on the inverter internal circuits.
A090: External Alarm	External alarm via DI. Note: - Necessary to set the DI in C7.10.1.	- DI input wiring (set in C7.10.1 to generate external alarm) open.
F091: External Protection	External fault via DI. Note: - Necessary to set the DI in C7.10.2.	- DI input wiring (set in C7.10.2 to generate external fault) open.
F099: Invalid Curr. Offset	Current measurement circuit has a value out of the standards for zero current.	- Defect on the inverter internal circuits.
F104: A/D Converter Error	Fault reading the A/D converter that measures the inverter currents and voltages.	- Defect on the inverter internal circuits. - Electromagnetic interference above the level the inverter withstands.
A110: High Motor Temperature	Alarm related to the PTC temperature sensor installed on the motor. Note: - The alarm can be disabled by setting C7.5.2. - It is necessary to program Slot X analog input and output for PTC function.	- Load on the motor shaft is too high. - Load cycle is too short (high number of starts and stops per minute). High ambient temperature around the motor. - Poor contact or short circuit (resistance < 100 Ω) on the wiring connected to the motor thermistor. Motor thermistor not installed. - Motor shaft locked.
A128: Serial Communication Timeout	It indicates that the CFW900 stopped receiving telegrams on the serial interface for a period longer than the setting programmed in C9.3.5. Note: - Make sure the master always sends telegrams to the equipment within a period shorter than the setting in C9.3.5.. - It can be disabled by setting C9.3.5=0.0 s.	- Check network installation, broken cable or fault/poor contact on the connections with the network, and grounding.
A133: No Power Supply on the CAN Interface	It actuates when the CAN interface is powered and lack of power supply to the interface is detected. Note: Measure if there is voltage within the allowed range between pins 1 and 5 of the CAN interface connector.	- CAN interface without power supply between pins 1 and 5 of the connector. - Power cables switched or reversed. - Poor contact on the CAN interface cable or connector.
A134: Bus Off	The bus off error in the CAN interface has been detected. If the number of reception or transmission errors detected by the CAN interface is too high, the CAN controller can be taken to the bus off state, where it interrupts the communication and disables the CAN interface. In order that the communication be reestablished, it will be necessary to cycle the power of the product, or remove the power supply from the CAN interface and apply it again, so that the communication be reinitiated.	- Verify if there is any short-circuit between the CAN circuit transmission cables. - Verify if the cables have not been changed or inverted. - Verify if all the network devices use the same baud rate. - Verify if termination resistors with the correct values were installed only at the extremes of the main bus. - Verify if the CAN network installation was carried out in proper manner.

Protection/Alarm	Description	Possible causes
A135: CANopen Off-line	It occurs if the state of the CANopen node changes from operational to pre-operational. Note: - Check the operation of the error control mechanisms (Heartbeat/Node Guarding).	- The master is not sending the guarding/heartbeat telegrams at the programmed time. - Communication problems caused by lost telegrams or transmission delays.
A136: Master in Idle	It actuates when communicating with the DeviceNet network master in Run mode, and transition to Idle mode is detected.	- Set the switch that controls the master operation of the master to Run or the corresponding bit on the configuration word of the master software. For further explanations, see the documentation of the master in use.
A137: DeviceNet connection timeout	It indicates that one or more DeviceNet I/O connections has expired. It occurs when, for some reason, after the cyclical communication between the master and the product has started, this communication is interrupted.	- Check the status of the network master. - Check network installation, broken cable or fault/poor contact on the connections with the network.
A145: SNTP Connection Timeout	It indicates that the inverter tried to connect to the NTP server and got no response. It occurs when, for some reason, after starting connection with the NTP server, the server did not return the response requested by the inverter.	<ul style="list-style-type: none"> ■ Check configuration and IP address. ■ Check if the NTP server is still active.
A149: Timeout Modbus TCP	It indicates that the device stopped receiving valid telegrams for a period longer than the setting in C9.6.3. The time counting starts as soon as it receives the first valid telegram.	- Check network installation, broken cable or fault/poor contact on the connections with the network, grounding. - Ensure the Modbus TCP client always sends telegrams to the equipment in a time shorter than the setting in C9.6.3. - Disable this function in C9.6.3.
F150: Motor Overspeed	Overspeed fault. Note: - Activated when the actual speed exceeds the value of C4.3.1.1.2 x (100 % + C7.7.1) for more than 20 ms.	- Incorrect setting of C3.3.2.1.2 and/or C3.3.2.1.3. - Crane-type load trips.
A152: Pow.Int. Air Overtemp.	High internal air temperature alarm. Note: - The alarm can be disabled by setting C7.5.1.	- High ambient temperature around the inverter (>50 °C) and high output current. - Defective internal fan (when applicable).
F153: Pow.Int. Air Overtemp.	Internal air overtemperature fault.	- High ambient temperature around the inverter (>50 °C) and high output current. - Defective internal fan (when applicable).
A154: Cont.Int.Air Overtemp.	Control circuit high temperature alarm. Note: - The alarm can be disabled by setting C7.5.1.	- High ambient temperature around the inverter (>50 °C) and high output current. - Locked or defective fan. - Inverter heat sink too dirty.
F155: Cont.Int.Air Overtemp.	Control circuit overtemperature fault.	- High ambient temperature around the inverter (>50 °C) and high output current. - Locked or defective fan. - Inverter heat sink too dirty.
A156: IGBT undertemperature	Alarm of undertemperature measured by the sensors in the IGBTs, rectifier, power and/or control below -30 °C. Note: - The alarm can be disabled by setting C7.5.1.	- Ambient temperature around the inverter \leq -30 °C.

Protection/Alarm	Description	Possible causes
F157: IGBT undertemperature	Fault of undertemperature measured by the sensors in the IGBTs, rectifier, power and/or control below -30 °C.	- Ambient temperature around the inverter \leq -30 °C.
F158: Corrupted settings	Inverter settings are invalid. Note: - Restore the settings from a backup.	- Parameter settings file cannot be restored correctly.
F160: STO90 Fault	It indicates to the user that STO90 is in a fault state.	- Incorrect installation of the safety inputs circuit (STO1 and STO2). - Actuation time between the safety inputs (STO1 and STO2) greater than 1 s. - Incorrect setting of the safety input type (dry contact or OSSD) on DIP switches S1. - DIP switches S2 activated in a state other than the STO state. - Incorrect programming of the safety function or programming timeout (2 min). - Damage in the electronic circuit of STO90.
F161: STO90 Off-line	It indicates to the user that CFW900 central control has lost communication with STO90.	- Poor contact between STO90 and CFW900 central control. - Damage in the electronic circuit of STO90 or CFW900 central control.
F171: Pow. Fan 1 Speed	Heat sink fan 1 speed fault.	- Dirt on the fan blades and rolling bearings. - Defective fan. - Defective fan power supply connection.
F172: Pow. Fan 2 Speed	Heat sink fan 2 speed fault.	- Dirt on the fan blades and rolling bearings. - Defective fan. - Defective fan power supply connection.
F173: Pow. Fan 3 Speed	Heat sink fan 3 speed fault.	- Dirt on the fan blades and rolling bearings. - Defective fan. - Defective fan power supply connection.
F174: Pow. Fan 4 Speed	Heat sink fan 4 speed fault.	- Dirt on the fan blades and rolling bearings. - Defective fan. - Defective fan power supply connection.
F175: Int. Fan 1 Speed	Internal fan 1 speed fault.	- Dirt on the fan blades and rolling bearings. - Defective fan. - Defective fan power supply connection.
F176: Int. Fan 2 Speed	Internal fan 2 speed fault.	- Dirt on the fan blades and rolling bearings. - Defective fan. - Defective fan power supply connection.
A181: Clock with invalid value	Clock with wrong time.	- Set the date and time in C11.1.2. - Battery low, defective or not installed.
F185: Pre-charge Protection	It indicates pre-charge contactor fault.	- Defective pre-charge contactor. - Command fuse open. - Phase loss at input L1/R or L2/S.
A186: Pow. Fan 1 Speed	Heat sink fan low speed alarm.	- Dirt on the fan blades and rolling bearings. - Defective fan. - Defective fan power supply connection.

Protection/Alarm	Description	Possible causes
A187: Pow. Fan 2 Speed	Heat sink fan low speed alarm.	<ul style="list-style-type: none"> - Dirt on the fan blades and rolling bearings. - Defective fan. - Defective fan power supply connection.
A188: Pow. Fan 3 Speed	Heat sink fan low speed alarm.	<ul style="list-style-type: none"> - Dirt on the fan blades and rolling bearings. - Defective fan. - Defective fan power supply connection.
A189: Pow. Fan 4 Speed	Heat sink fan low speed alarm.	<ul style="list-style-type: none"> - Dirt on the fan blades and rolling bearings. - Defective fan. - Defective fan power supply connection.
A190: Int. Fan 1 Speed	Internal fan low speed alarm.	<ul style="list-style-type: none"> - Dirt on the fan blades and rolling bearings. - Defective fan. - Defective fan power supply connection.
A191: Int. Fan 2 Speed	Internal fan low speed alarm.	<ul style="list-style-type: none"> - Dirt on the fan blades and rolling bearings. - Defective fan. - Defective fan power supply connection.
F228: Serial Communication Timeout	<p>It indicates that the CFW900 stopped receiving telegrams on the serial interface for a period longer than the setting programmed in C9.3.5.</p> <p>Note:</p> <ul style="list-style-type: none"> - Make sure the master always sends telegrams to the equipment within a period shorter than the setting in C9.3.5.. - It can be disabled by setting C9.3.5=0.0 s. 	<ul style="list-style-type: none"> - Check network installation, broken cable or fault/poor contact on the connections with the network, and grounding.
F233: No Power Supply on the CAN Interface	<p>It actuates when the CAN interface is powered and lack of power supply to the interface is detected.</p> <p>Note:</p> <p>Measure if there is voltage within the allowed range between pins 1 and 5 of the CAN interface connector.</p>	<ul style="list-style-type: none"> - CAN interface without power supply between pins 1 and 5 of the connector. - Power cables switched or reversed. - Poor contact on the CAN interface cable or connector.
F234: Bus Off	<p>The bus off error in the CAN interface has been detected.</p> <p>If the number of reception or transmission errors detected by the CAN interface is too high, the CAN controller can be taken to the bus off state, where it interrupts the communication and disables the CAN interface.</p> <p>In order that the communication be reestablished, it will be necessary to cycle the power of the product, or remove the power supply from the CAN interface and apply it again, so that the communication be reinitiated.</p>	<ul style="list-style-type: none"> - Verify if there is any short-circuit between the CAN circuit transmission cables. - Verify if the cables have not been changed or inverted. - Verify if all the network devices use the same baud rate. - Verify if termination resistors with the correct values were installed only at the extremes of the main bus. - Verify if the CAN network installation was carried out in proper manner.
F235: CANopen Off-line	<p>It occurs if the state of the CANopen node changes from operational to pre-operational.</p> <p>Note:</p> <ul style="list-style-type: none"> - Check the operation of the error control mechanisms (Heartbeat/Node Guarding). 	<ul style="list-style-type: none"> - The master is not sending the guarding/heartbeat telegrams at the programmed time. - Communication problems caused by lost telegrams or transmission delays.
F236: Master in Idle	<p>It actuates when communicating with the DeviceNet network master in Run mode, and transition to Idle mode is detected.</p>	<ul style="list-style-type: none"> - Set the switch that controls the master operation of the master to Run or the corresponding bit on the configuration word of the master software. For further explanations, see the documentation of the master in use.

Protection/Alarm	Description	Possible causes
F237: DeviceNet connection timeout	It indicates that one or more DeviceNet I/O connections has expired. It occurs when, for some reason, after the cyclical communication between the master and the product has started, this communication is interrupted.	<ul style="list-style-type: none"> - Check the status of the network master. - Check network installation, broken cable or fault/poor contact on the connections with the network.
F249: Modbus TCP Timeout	It indicates that the device stopped receiving valid telegrams for a period longer than the setting in C9.6.3. The time counting starts as soon as it receives the first valid telegram.	<ul style="list-style-type: none"> - Check network installation, broken cable or fault/poor contact on the connections with the network, grounding. - Ensure the Modbus TCP client always sends telegrams to the equipment in a time shorter than the setting in C9.6.3. - Disable this function in C9.6.3.
A345: IGBT P.U B1 High Load	Alarm of overload on IGBT 1 of phase U.	<ul style="list-style-type: none"> - High current at the inverter output.
F346: IGBT P.U B1 Overload	Fault of overload on IGBT 1 of phase U.	<ul style="list-style-type: none"> - High current at the inverter output.
A348: IGBT P.V B1 High Load	Alarm of overload on IGBT 1 of phase V.	<ul style="list-style-type: none"> - High current at the inverter output.
F349: IGBT P.V B1 Overload	Fault of overload on IGBT 1 of phase V.	<ul style="list-style-type: none"> - High current at the inverter output.
A351: IGBT P.W B1 High Load	Alarm of overload on IGBT 1 of phase W.	<ul style="list-style-type: none"> - High current at the inverter output.
F352: IGBT P.W B1 Overload	Fault of overload on IGBT 1 of phase W.	<ul style="list-style-type: none"> - High current at the inverter output.
A354: IGBT P.U B2 High Load	Alarm of overload on IGBT 2 of phase U.	<ul style="list-style-type: none"> - High current at the inverter output.
F355: IGBT P.U B2 Overload	Fault of overload on IGBT 2 of phase U.	<ul style="list-style-type: none"> - High current at the inverter output.
A357: IGBT P.V B2 High Load	Alarm of overload on IGBT 2 of phase V.	<ul style="list-style-type: none"> - High current at the inverter output.
F358: IGBT P.V B2 Overload	Fault of overload on IGBT 2 of phase V.	<ul style="list-style-type: none"> - High current at the inverter output.
A360: IGBT P.W B2 High Load	Alarm of overload on IGBT 2 of phase W.	<ul style="list-style-type: none"> - High current at the inverter output.
F361: IGBT P.W B2 Overload	Fault of overload on IGBT 2 of phase W.	<ul style="list-style-type: none"> - High current at the inverter output.
F600: Pulse Update Error	Fault related to updating the PWM pulses.	<ul style="list-style-type: none"> - Defect on the inverter internal circuits.
F606: Power Monitor Comm Lost	Communication fault between AUI and PMON.	<ul style="list-style-type: none"> - Defect on the inverter internal circuits. - Electromagnetic interference above the level the inverter withstands. - Power board turned off.
F607: SMM Comm Lost	Communication fault between PWC and SMM.	<ul style="list-style-type: none"> - Defect on the inverter internal circuits. - Electromagnetic interference above the level the inverter withstands. - Safety interface board turned off.
F608: Code Flow Failure	Internal fault during inverter operation. Note: <ul style="list-style-type: none"> - Reset the inverter. - Load the factory default. 	<ul style="list-style-type: none"> - If the problem persists, please contact WEG assistance.

Protection/Alarm	Description	Possible causes
F609: Model Version Incompatible	Inverter model data version is incompatible with the actual firmware. Note: - Contact technical support to arrange the model update.	
A700: HMI Disconnected	Alarm related to the HMI disconnection.	- Commands configured via HMI, and HMI is not connected to the inverter.
F701: HMI Disconnected	Fault related to the HMI disconnection.	- Commands configured via HMI, and HMI is not connected to the inverter.
A702: Inverter Disabled	Alarm indicates that the General Enable command is Inactive.	- Run/Stop command of the SoftPLC application equal to Run, or the movement block was enabled with the inverter in general disable.
A706: SPLC Refer. Not Progr.	Reference not programmed for SoftPLC.	- It occurs when a movement block is enabled and the speed reference is not set for SoftPLC (check C4.3.1.2).
A708: SoftPLC Not Running	SoftPLC application is not running.	- Check the SoftPLC status in S6.1.1 and the action configuration for application not running in C10.1.3.
F709: SoftPLC Not Running	SoftPLC application is not running.	- Check the SoftPLC status in S6.1.1 and the action configuration for application not running in C10.1.3.
F1000: Accessory firmware update error	Error during accessory firmware update.	Old inverter firmware version.
A1012: Default Slot AI1 cable disconnection	Analog input signal set to actual mode is out of the range 4 to 20 mA.	- AI cable broken (the read value was less than 2 mA for 5 seconds). Poor contact on the signal connection at the terminals.
F1013: Default Slot AI1 cable disconnection	Analog input signal set to actual mode is out of the range 4 to 20 mA.	- AI cable broken (the read value was less than 2 mA for 5 seconds). Poor contact on the signal connection at the terminals.
A1014: Default Slot AI2 cable disconnection	Analog input signal set to actual mode is out of the range 4 to 20 mA.	- AI cable broken (the read value was less than 2 mA for 5 seconds). Poor contact on the signal connection at the terminals.
F1015: Default Slot AI2 cable disconnection	Analog input signal set to actual mode is out of the range 4 to 20 mA.	- AI cable broken (the read value was less than 2 mA for 5 seconds). Poor contact on the signal connection at the terminals.
F1100: Slot A incompatible accessory	Error during accessory firmware update.	Old inverter firmware version.
F1101: Slot A Initialization Error	It was not possible to initialize a resource required for the accessory to work.	- Resource already in use by another accessory. In the case of communication network accessories, only one accessory of each type of network can be connected to the inverter at a time.
F1103: Slot A accessory connection	Loss of communication with the accessory.	- Above-supported electromagnetic noise. - Vibration above supported limits causing connector problems. - Corrupted accessory firmware.

Protection/Alarm	Description	Possible causes
A1104: Slot A high temperature	Temperature in the accessory is high.	- Temperature around the inverter close to 60 °C.
F1105: Slot A overtemperature	Accessory overtemperature.	- Temperature around the inverter above 60 °C.
A1106: Slot A enc. A cable disconnection	Encoder signal not detected correctly Note: It can be disabled by setting C5.n.6.2, where n is the number of the slot where the accessory is installed.	- Broken or disconnected signal cable. - Encoder connection error. - Encoder without power supply.
F1107: Slot A enc. A cable disconnection	Encoder signal not detected correctly Note: It can be disabled by setting C5.n.6.2, where n is the number of the slot where the accessory is installed.	- Broken or disconnected signal cable. - Encoder connection error. - Encoder without power supply.
A1108: Slot A enc. B cable disconnection	Encoder signal not detected correctly Note: It can be disabled by setting C5.n.6.2, where n is the number of the slot where the accessory is installed.	- Broken or disconnected signal cable. - Encoder connection error. - Encoder without power supply.
F1109: Slot A enc. B cable disconnection	Encoder signal not detected correctly Note: It can be disabled by setting C5.n.6.2, where n is the number of the slot where the accessory is installed.	- Broken or disconnected signal cable. - Encoder connection error. - Encoder without power supply.
A1110: Slot A enc. Z cable disconnection	Encoder signal Z not detected correctly	- Broken or disconnected signal cable. - Encoder connection error. - Encoder without power supply.
F1111: Slot A enc. Z cable disconnection	Encoder signal Z not detected correctly	- Broken or disconnected signal cable. - Encoder connection error. - Encoder without power supply.
A1112: Slot A AI1 cable disconnection	Analog input signal set to actual mode is out of the range 4 to 20 mA.	- AI cable broken (the read value was less than 2 mA for 5 seconds). Poor contact on the signal connection at the terminals.
F1113: Slot A AI1 cable disconnection	Analog input signal set to actual mode is out of the range 4 to 20 mA.	- AI cable broken (the read value was less than 2 mA for 5 seconds). Poor contact on the signal connection at the terminals.
A1114: Slot A AI2 cable disconnection	Analog input signal set to actual mode is out of the range 4 to 20 mA.	- AI cable broken (the read value was less than 2 mA for 5 seconds). Poor contact on the signal connection at the terminals.
F1115: Slot A AI2 cable disconnection	Analog input signal set to actual mode is out of the range 4 to 20 mA.	- AI cable broken (the read value was less than 2 mA for 5 seconds). Poor contact on the signal connection at the terminals.
A1116: Slot A AI3 cable disconnection	Analog input signal set to actual mode is out of the range 4 to 20 mA.	- AI cable broken (the read value was less than 2 mA for 5 seconds). Poor contact on the signal connection at the terminals.

Protection/Alarm	Description	Possible causes
F1117: Slot A AI3 cable disconnection	Analog input signal set to actual mode is out of the range 4 to 20 mA.	- AI cable broken (the read value was less than 2 mA for 5 seconds). Poor contact on the signal connection at the terminals.
A1118: Slot A AI4 cable disconnection	Analog input signal set to actual mode is out of the range 4 to 20 mA.	- AI cable broken (the read value was less than 2 mA for 5 seconds). Poor contact on the signal connection at the terminals.
F1119: Slot A AI4 cable disconnection	Analog input signal set to actual mode is out of the range 4 to 20 mA.	- AI cable broken (the read value was less than 2 mA for 5 seconds). Poor contact on the signal connection at the terminals.
F1125: Slot A temp. sensor wrong hw config.	Sensor type selected by the accessory DIP switches other than the sensor type configured by the parameters.	- DIP switch configured incorrectly. Check the CFW900-TEMP-01 accessory guide. - "Sensor Type" parameter incorrectly configured. Check the description in C5.2.6.1.
A1126: Slot A temperature sensor 1 error	Value measured by the temperature sensor out of the expected range.	- Sensor cable is broken. - Short-circuited sensor. - Sensor located in an extremely low temperature environment.
F1127: Slot A temperature sensor 1 error	Value measured by the temperature sensor out of the expected range.	- Sensor cable is broken. - Short-circuited sensor. - Sensor located in an extremely low temperature environment.
A1128: Slot A high temperature in sensor 1	Temperature measured by the sensor close to the threshold level.	- Monitored equipment at a high temperature. - Fault actuation level configuration error.
F1129: Slot A sensor 1 overtemperature	Temperature measured by the sensor close to the threshold level.	- Monitored equipment at a high temperature. - Fault actuation level configuration error.
A1130: Slot A temperature sensor 2 error	Value measured by the temperature sensor out of the expected range.	- Sensor cable is broken. - Short-circuited sensor. - Sensor located in an extremely low temperature environment.
F1131: Slot A temperature sensor 2 error	Value measured by the temperature sensor out of the expected range.	- Sensor cable is broken. - Short-circuited sensor. - Sensor located in an extremely low temperature environment.
A1132: Slot A high temperature in sensor 2	Temperature measured by the sensor close to the threshold level.	- Monitored equipment at a high temperature. - Fault actuation level configuration error.
F1133: Slot A sensor 2 overtemperature	Temperature measured by the sensor close to the threshold level.	- Monitored equipment at a high temperature. - Fault actuation level configuration error.
A1134: Slot A temperature sensor 3 error	Value measured by the temperature sensor out of the expected range.	- Sensor cable is broken. - Short-circuited sensor. - Sensor located in an extremely low temperature environment.
F1135: Slot A temperature sensor 3 error	Value measured by the temperature sensor out of the expected range.	- Sensor cable is broken. - Short-circuited sensor. - Sensor located in an extremely low temperature environment.
A1136: Slot A high temperature in sensor 3	Temperature measured by the sensor close to the threshold level.	- Monitored equipment at a high temperature. - Fault actuation level configuration error.

Protection/Alarm	Description	Possible causes
F1137: Slot A sensor 3 overtemperature	Temperature measured by the sensor close to the threshold level.	<ul style="list-style-type: none"> - Monitored equipment at a high temperature. - Fault actuation level configuration error.
A1138: Slot A temperature sensor 4 error	Value measured by the temperature sensor out of the expected range.	<ul style="list-style-type: none"> - Sensor cable is broken. - Short-circuited sensor. - Sensor located in an extremely low temperature environment.
F1139: Slot A temperature sensor 4 error	Value measured by the temperature sensor out of the expected range.	<ul style="list-style-type: none"> - Sensor cable is broken. - Short-circuited sensor. - Sensor located in an extremely low temperature environment.
A1140: Slot A high temperature in sensor 4	Temperature measured by the sensor close to the threshold level.	<ul style="list-style-type: none"> - Monitored equipment at a high temperature. - Fault actuation level configuration error.
F1141: Slot A sensor 4 overtemperature	Temperature measured by the sensor close to the threshold level.	<ul style="list-style-type: none"> - Monitored equipment at a high temperature. - Fault actuation level configuration error.
A1142: Slot A temperature sensor 5 error	Value measured by the temperature sensor out of the expected range.	<ul style="list-style-type: none"> - Sensor cable is broken. - Short-circuited sensor. - Sensor located in an extremely low temperature environment.
F1143: Slot A temperature sensor 5 error	Value measured by the temperature sensor out of the expected range.	<ul style="list-style-type: none"> - Sensor cable is broken. - Short-circuited sensor. - Sensor located in an extremely low temperature environment.
A1144: Slot A high temperature in sensor 5	Temperature measured by the sensor close to the threshold level.	<ul style="list-style-type: none"> - Monitored equipment at a high temperature. - Fault actuation level configuration error.
F1145: Slot A sensor 5 overtemperature	Temperature measured by the sensor close to the threshold level.	<ul style="list-style-type: none"> - Monitored equipment at a high temperature. - Fault actuation level configuration error.
A1146: Slot A temperature sensor 6 error	Value measured by the temperature sensor out of the expected range.	<ul style="list-style-type: none"> - Sensor cable is broken. - Short-circuited sensor. - Sensor located in an extremely low temperature environment.
F1147: Slot A temperature sensor 6 error	Value measured by the temperature sensor out of the expected range.	<ul style="list-style-type: none"> - Sensor cable is broken. - Short-circuited sensor. - Sensor located in an extremely low temperature environment.
A1148: Slot A high temperature in sensor 6	Temperature measured by the sensor close to the threshold level.	<ul style="list-style-type: none"> - Monitored equipment at a high temperature. - Fault actuation level configuration error.
F1149: Slot A sensor 6 overtemperature	Temperature measured by the sensor close to the threshold level.	<ul style="list-style-type: none"> - Monitored equipment at a high temperature. - Fault actuation level configuration error.
F1200: Slot B incompatible accessory	Error during accessory firmware update.	Old inverter firmware version.
F1201: Slot B Initialization Error	It was not possible to initialize a resource required for the accessory to work.	<ul style="list-style-type: none"> - Resource already in use by another accessory. In the case of communication network accessories, only one accessory of each type of network can be connected to the inverter at a time.
F1203: Slot B accessory connection	Loss of communication with the accessory.	<ul style="list-style-type: none"> - Above-supported electromagnetic noise. - Vibration above supported limits causing connector problems. - Corrupted accessory firmware.

Protection/Alarm	Description	Possible causes
A1204: Slot B high temperature	Temperature in the accessory is high.	- Temperature around the inverter close to 60 °C.
F1205: Slot B overtemperature	Accessory overtemperature.	- Temperature around the inverter above 60 °C.
A1206: Slot B enc. A cable disconnection	Encoder signal not detected correctly Note: It can be disabled by setting C5.n.6.2, where n is the number of the slot where the accessory is installed.	- Broken or disconnected signal cable. - Encoder connection error. - Encoder without power supply.
F1207: Slot B enc. A cable disconnection	Encoder signal not detected correctly Note: It can be disabled by setting C5.n.6.2, where n is the number of the slot where the accessory is installed.	- Broken or disconnected signal cable. - Encoder connection error. - Encoder without power supply.
A1208: Slot B enc. B cable disconnection	Encoder signal not detected correctly Note: It can be disabled by setting C5.n.6.2, where n is the number of the slot where the accessory is installed.	- Broken or disconnected signal cable. - Encoder connection error. - Encoder without power supply.
F1209: Slot B enc. B cable disconnection	Encoder signal not detected correctly Note: It can be disabled by setting C5.n.6.2, where n is the number of the slot where the accessory is installed.	- Broken or disconnected signal cable. - Encoder connection error. - Encoder without power supply.
A1210: Slot B enc. Z cable disconnection	Encoder signal Z not detected correctly	- Broken or disconnected signal cable. - Encoder connection error. - Encoder without power supply.
F1211: Slot B enc. Z cable disconnection	Encoder signal Z not detected correctly	- Broken or disconnected signal cable. - Encoder connection error. - Encoder without power supply.
A1212: Slot B AI1 cable disconnection	Analog input signal set to actual mode is out of the range 4 to 20 mA.	- AI cable broken (the read value was less than 2 mA for 5 seconds). Poor contact on the signal connection at the terminals.
F1213: Slot B AI1 cable disconnection	Analog input signal set to actual mode is out of the range 4 to 20 mA.	- AI cable broken (the read value was less than 2 mA for 5 seconds). Poor contact on the signal connection at the terminals.
A1214: Slot B AI2 cable disconnection	Analog input signal set to actual mode is out of the range 4 to 20 mA.	- AI cable broken (the read value was less than 2 mA for 5 seconds). Poor contact on the signal connection at the terminals.
F1215: Slot B AI2 cable disconnection	Analog input signal set to actual mode is out of the range 4 to 20 mA.	- AI cable broken (the read value was less than 2 mA for 5 seconds). Poor contact on the signal connection at the terminals.
A1216: Slot B AI3 cable disconnection	Analog input signal set to actual mode is out of the range 4 to 20 mA.	- AI cable broken (the read value was less than 2 mA for 5 seconds). Poor contact on the signal connection at the terminals.

Protection/Alarm	Description	Possible causes
F1217: Slot B AI3 cable disconnection	Analog input signal set to actual mode is out of the range 4 to 20 mA.	- AI cable broken (the read value was less than 2 mA for 5 seconds). Poor contact on the signal connection at the terminals.
A1218: Slot B AI4 cable disconnection	Analog input signal set to actual mode is out of the range 4 to 20 mA.	- AI cable broken (the read value was less than 2 mA for 5 seconds). Poor contact on the signal connection at the terminals.
F1219: Slot B AI4 cable disconnection	Analog input signal set to actual mode is out of the range 4 to 20 mA.	- AI cable broken (the read value was less than 2 mA for 5 seconds). Poor contact on the signal connection at the terminals.
F1225: Slot B temp. sensor wrong hw config.	Sensor type selected by the accessory DIP switches other than the sensor type configured by the parameters.	- DIP switch configured incorrectly. Check the CFW900-TEMP-01 accessory guide. - "Sensor Type" parameter incorrectly configured. Check the description in C5.2.6.1.
A1226: Slot B temperature sensor 1 error	Value measured by the temperature sensor out of the expected range.	- Sensor cable is broken. - Short-circuited sensor. - Sensor located in an extremely low temperature environment.
F1227: Slot B temperature sensor 1 error	Value measured by the temperature sensor out of the expected range.	- Sensor cable is broken. - Short-circuited sensor. - Sensor located in an extremely low temperature environment.
A1228: Slot B high temperature in sensor 1	Temperature measured by the sensor close to the threshold level.	- Monitored equipment at a high temperature. - Fault actuation level configuration error.
F1229: Slot B sensor 1 overtemperature	Temperature measured by the sensor close to the threshold level.	- Monitored equipment at a high temperature. - Fault actuation level configuration error.
A1230: Slot B temperature sensor 2 error	Value measured by the temperature sensor out of the expected range.	- Sensor cable is broken. - Short-circuited sensor. - Sensor located in an extremely low temperature environment.
F1231: Slot B temperature sensor 2 error	Value measured by the temperature sensor out of the expected range.	- Sensor cable is broken. - Short-circuited sensor. - Sensor located in an extremely low temperature environment.
A1232: Slot B high temperature in sensor 2	Temperature measured by the sensor close to the threshold level.	- Monitored equipment at a high temperature. - Fault actuation level configuration error.
F1233: Slot B sensor 2 overtemperature	Temperature measured by the sensor close to the threshold level.	- Monitored equipment at a high temperature. - Fault actuation level configuration error.
A1234: Slot B temperature sensor 3 error	Value measured by the temperature sensor out of the expected range.	- Sensor cable is broken. - Short-circuited sensor. - Sensor located in an extremely low temperature environment.
F1235: Slot B temperature sensor 3 error	Value measured by the temperature sensor out of the expected range.	- Sensor cable is broken. - Short-circuited sensor. - Sensor located in an extremely low temperature environment.
A1236: Slot B high temperature in sensor 3	Temperature measured by the sensor close to the threshold level.	- Monitored equipment at a high temperature. - Fault actuation level configuration error.

Protection/Alarm	Description	Possible causes
F1237: Slot B sensor 3 overtemperature	Temperature measured by the sensor close to the threshold level.	- Monitored equipment at a high temperature. - Fault actuation level configuration error.
A1238: Slot B temperature sensor 4 error	Value measured by the temperature sensor out of the expected range.	- Sensor cable is broken. - Short-circuited sensor. - Sensor located in an extremely low temperature environment.
F1239: Slot B temperature sensor 4 error	Value measured by the temperature sensor out of the expected range.	- Sensor cable is broken. - Short-circuited sensor. - Sensor located in an extremely low temperature environment.
A1240: Slot B high temperature in sensor 4	Temperature measured by the sensor close to the threshold level.	- Monitored equipment at a high temperature. - Fault actuation level configuration error.
F1241: Slot B sensor 4 overtemperature	Temperature measured by the sensor close to the threshold level.	- Monitored equipment at a high temperature. - Fault actuation level configuration error.
A1242: Slot B temperature sensor 5 error	Value measured by the temperature sensor out of the expected range.	- Sensor cable is broken. - Short-circuited sensor. - Sensor located in an extremely low temperature environment.
F1243: Slot B temperature sensor 5 error	Value measured by the temperature sensor out of the expected range.	- Sensor cable is broken. - Short-circuited sensor. - Sensor located in an extremely low temperature environment.
A1244: Slot B high temperature in sensor 5	Temperature measured by the sensor close to the threshold level.	- Monitored equipment at a high temperature. - Fault actuation level configuration error.
F1245: Slot B sensor 5 overtemperature	Temperature measured by the sensor close to the threshold level.	- Monitored equipment at a high temperature. - Fault actuation level configuration error.
A1246: Slot B temperature sensor 6 error	Value measured by the temperature sensor out of the expected range.	- Sensor cable is broken. - Short-circuited sensor. - Sensor located in an extremely low temperature environment.
F1247: Slot B temperature sensor 6 error	Value measured by the temperature sensor out of the expected range.	- Sensor cable is broken. - Short-circuited sensor. - Sensor located in an extremely low temperature environment.
A1248: Slot B high temperature in sensor 6	Temperature measured by the sensor close to the threshold level.	- Monitored equipment at a high temperature. - Fault actuation level configuration error.
F1249: Slot B sensor 6 overtemperature	Temperature measured by the sensor close to the threshold level.	- Monitored equipment at a high temperature. - Fault actuation level configuration error.
F1300: Slot C incompatible accessory	Error during accessory firmware update.	Old inverter firmware version.
F1301: Slot C Initialization Error	It was not possible to initialize a resource required for the accessory to work.	- Resource already in use by another accessory. In the case of communication network accessories, only one accessory of each type of network can be connected to the inverter at a time.
F1303: Slot C accessory connection	Loss of communication with the accessory.	- Above-supported electromagnetic noise. - Vibration above supported limits causing connector problems. - Corrupted accessory firmware.

Protection/Alarm	Description	Possible causes
A1304: Slot C high temperature	Temperature in the accessory is high.	- Temperature around the inverter close to 60 °C.
F1305: Slot C overtemperature	Accessory overtemperature.	- Temperature around the inverter above 60 °C.
A1306: Slot C enc. A cable disconnection	Encoder signal not detected correctly Note: It can be disabled by setting C5.n.6.2, where n is the number of the slot where the accessory is installed.	- Broken or disconnected signal cable. - Encoder connection error. - Encoder without power supply.
F1307: Slot C enc. A cable disconnection	Encoder signal not detected correctly Note: It can be disabled by setting C5.n.6.2, where n is the number of the slot where the accessory is installed.	- Broken or disconnected signal cable. - Encoder connection error. - Encoder without power supply.
A1308: Slot C enc. B cable disconnection	Encoder signal not detected correctly Note: It can be disabled by setting C5.n.6.2, where n is the number of the slot where the accessory is installed.	- Broken or disconnected signal cable. - Encoder connection error. - Encoder without power supply.
F1309: Slot C enc. B cable disconnection	Encoder signal not detected correctly Note: It can be disabled by setting C5.n.6.2, where n is the number of the slot where the accessory is installed.	- Broken or disconnected signal cable. - Encoder connection error. - Encoder without power supply.
A1310: Slot C enc. Z cable disconnection	Encoder signal Z not detected correctly	- Broken or disconnected signal cable. - Encoder connection error. - Encoder without power supply.
F1311: Slot C enc. Z cable disconnection	Encoder signal Z not detected correctly	- Broken or disconnected signal cable. - Encoder connection error. - Encoder without power supply.
A1312: Slot C AI1 cable disconnection	Analog input signal set to actual mode is out of the range 4 to 20 mA.	- AI cable broken (the read value was less than 2 mA for 5 seconds). Poor contact on the signal connection at the terminals.
F1313: Slot C AI1 cable disconnection	Analog input signal set to actual mode is out of the range 4 to 20 mA.	- AI cable broken (the read value was less than 2 mA for 5 seconds). Poor contact on the signal connection at the terminals.
A1314: Slot C AI2 cable disconnection	Analog input signal set to actual mode is out of the range 4 to 20 mA.	- AI cable broken (the read value was less than 2 mA for 5 seconds). Poor contact on the signal connection at the terminals.
F1315: Slot C AI2 cable disconnection	Analog input signal set to actual mode is out of the range 4 to 20 mA.	- AI cable broken (the read value was less than 2 mA for 5 seconds). Poor contact on the signal connection at the terminals.
A1316: Slot C AI3 cable disconnection	Analog input signal set to actual mode is out of the range 4 to 20 mA.	- AI cable broken (the read value was less than 2 mA for 5 seconds). Poor contact on the signal connection at the terminals.

Protection/Alarm	Description	Possible causes
F1317: Slot C AI3 cable disconnection	Analog input signal set to actual mode is out of the range 4 to 20 mA.	- AI cable broken (the read value was less than 2 mA for 5 seconds). Poor contact on the signal connection at the terminals.
A1318: Slot C AI4 cable disconnection	Analog input signal set to actual mode is out of the range 4 to 20 mA.	- AI cable broken (the read value was less than 2 mA for 5 seconds). Poor contact on the signal connection at the terminals.
F1319: Slot C AI4 cable disconnection	Analog input signal set to actual mode is out of the range 4 to 20 mA.	- AI cable broken (the read value was less than 2 mA for 5 seconds). Poor contact on the signal connection at the terminals.
F1325: Slot C temp. sensor wrong hw config.	Sensor type selected by the accessory DIP switches other than the sensor type configured by the parameters.	- DIP switch configured incorrectly. Check the CFW900-TEMP-01 accessory guide. - "Sensor Type" parameter incorrectly configured. Check the description in C5.2.6.1.
A1326: Slot C temperature sensor 1 error	Value measured by the temperature sensor out of the expected range.	- Sensor cable is broken. - Short-circuited sensor. - Sensor located in an extremely low temperature environment.
F1327: Slot C temperature sensor 1 error	Value measured by the temperature sensor out of the expected range.	- Sensor cable is broken. - Short-circuited sensor. - Sensor located in an extremely low temperature environment.
A1328: Slot C high temperature in sensor 1	Temperature measured by the sensor close to the threshold level.	- Monitored equipment at a high temperature. - Fault actuation level configuration error.
F1329: Slot C sensor 1 overtemperature	Temperature measured by the sensor close to the threshold level.	- Monitored equipment at a high temperature. - Fault actuation level configuration error.
A1330: Slot C temperature sensor 2 error	Value measured by the temperature sensor out of the expected range.	- Sensor cable is broken. - Short-circuited sensor. - Sensor located in an extremely low temperature environment.
F1331: Slot C temperature sensor 2 error	Value measured by the temperature sensor out of the expected range.	- Sensor cable is broken. - Short-circuited sensor. - Sensor located in an extremely low temperature environment.
A1332: Slot C high temperature in sensor 2	Temperature measured by the sensor close to the threshold level.	- Monitored equipment at a high temperature. - Fault actuation level configuration error.
F1333: Slot C sensor 2 overtemperature	Temperature measured by the sensor close to the threshold level.	- Monitored equipment at a high temperature. - Fault actuation level configuration error.
A1334: Slot C temperature sensor 3 error	Value measured by the temperature sensor out of the expected range.	- Sensor cable is broken. - Short-circuited sensor. - Sensor located in an extremely low temperature environment.
F1335: Slot C temperature sensor 3 error	Value measured by the temperature sensor out of the expected range.	- Sensor cable is broken. - Short-circuited sensor. - Sensor located in an extremely low temperature environment.
A1336: Slot C high temperature in sensor 3	Temperature measured by the sensor close to the threshold level.	- Monitored equipment at a high temperature. - Fault actuation level configuration error.

Protection/Alarm	Description	Possible causes
F1337: Slot C sensor 3 overtemperature	Temperature measured by the sensor close to the threshold level.	<ul style="list-style-type: none"> - Monitored equipment at a high temperature. - Fault actuation level configuration error.
A1338: Slot C temperature sensor 4 error	Value measured by the temperature sensor out of the expected range.	<ul style="list-style-type: none"> - Sensor cable is broken. - Short-circuited sensor. - Sensor located in an extremely low temperature environment.
F1339: Slot C temperature sensor 4 error	Value measured by the temperature sensor out of the expected range.	<ul style="list-style-type: none"> - Sensor cable is broken. - Short-circuited sensor. - Sensor located in an extremely low temperature environment.
A1340: Slot C high temperature in sensor 4	Temperature measured by the sensor close to the threshold level.	<ul style="list-style-type: none"> - Monitored equipment at a high temperature. - Fault actuation level configuration error.
F1341: Slot C sensor 4 overtemperature	Temperature measured by the sensor close to the threshold level.	<ul style="list-style-type: none"> - Monitored equipment at a high temperature. - Fault actuation level configuration error.
A1342: Slot C temperature sensor 5 error	Value measured by the temperature sensor out of the expected range.	<ul style="list-style-type: none"> - Sensor cable is broken. - Short-circuited sensor. - Sensor located in an extremely low temperature environment.
F1343: Slot C temperature sensor 5 error	Value measured by the temperature sensor out of the expected range.	<ul style="list-style-type: none"> - Sensor cable is broken. - Short-circuited sensor. - Sensor located in an extremely low temperature environment.
A1344: Slot C high temperature in sensor 5	Temperature measured by the sensor close to the threshold level.	<ul style="list-style-type: none"> - Monitored equipment at a high temperature. - Fault actuation level configuration error.
F1345: Slot C sensor 5 overtemperature	Temperature measured by the sensor close to the threshold level.	<ul style="list-style-type: none"> - Monitored equipment at a high temperature. - Fault actuation level configuration error.
A1346: Slot C temperature sensor 6 error	Value measured by the temperature sensor out of the expected range.	<ul style="list-style-type: none"> - Sensor cable is broken. - Short-circuited sensor. - Sensor located in an extremely low temperature environment.
F1347: Slot C temperature sensor 6 error	Value measured by the temperature sensor out of the expected range.	<ul style="list-style-type: none"> - Sensor cable is broken. - Short-circuited sensor. - Sensor located in an extremely low temperature environment.
A1348: Slot C high temperature in sensor 6	Temperature measured by the sensor close to the threshold level.	<ul style="list-style-type: none"> - Monitored equipment at a high temperature. - Fault actuation level configuration error.
F1349: Slot C sensor 6 overtemperature	Temperature measured by the sensor close to the threshold level.	<ul style="list-style-type: none"> - Monitored equipment at a high temperature. - Fault actuation level configuration error.
F1400: Slot D incompatible accessory	Error during accessory firmware update.	Old inverter firmware version.
F1401: Slot D Initialization Error	It was not possible to initialize a resource required for the accessory to work.	<ul style="list-style-type: none"> - Resource already in use by another accessory. In the case of communication network accessories, only one accessory of each type of network can be connected to the inverter at a time.
F1403: Slot D accessory connection	Loss of communication with the accessory.	<ul style="list-style-type: none"> - Above-supported electromagnetic noise. - Vibration above supported limits causing connector problems. - Corrupted accessory firmware.

Protection/Alarm	Description	Possible causes
A1404: Slot D high temperature	Temperature in the accessory is high.	- Temperature around the inverter close to 60 °C.
F1405: Slot D overtemperature	Accessory overtemperature.	- Temperature around the inverter above 60 °C.
A1406: Slot D enc. A cable disconnection	Encoder signal not detected correctly Note: It can be disabled by setting C5.n.6.2, where n is the number of the slot where the accessory is installed.	- Broken or disconnected signal cable. - Encoder connection error. - Encoder without power supply.
F1407: Slot D enc. A cable disconnection	Encoder signal not detected correctly Note: It can be disabled by setting C5.n.6.2, where n is the number of the slot where the accessory is installed.	- Broken or disconnected signal cable. - Encoder connection error. - Encoder without power supply.
A1408: Slot D enc. B cable disconnection	Encoder signal not detected correctly Note: It can be disabled by setting C5.n.6.2, where n is the number of the slot where the accessory is installed.	- Broken or disconnected signal cable. - Encoder connection error. - Encoder without power supply.
F1409: Slot D enc. B cable disconnection	Encoder signal not detected correctly Note: It can be disabled by setting C5.n.6.2, where n is the number of the slot where the accessory is installed.	- Broken or disconnected signal cable. - Encoder connection error. - Encoder without power supply.
A1410: Slot D enc. Z cable disconnection	Encoder signal Z not detected correctly	- Broken or disconnected signal cable. - Encoder connection error. - Encoder without power supply.
F1411: Slot D enc. Z cable disconnection	Encoder signal Z not detected correctly	- Broken or disconnected signal cable. - Encoder connection error. - Encoder without power supply.
A1412: Slot D AI1 cable disconnection	Analog input signal set to actual mode is out of the range 4 to 20 mA.	- AI cable broken (the read value was less than 2 mA for 5 seconds). Poor contact on the signal connection at the terminals.
F1413: Slot D AI1 cable disconnection	Analog input signal set to actual mode is out of the range 4 to 20 mA.	- AI cable broken (the read value was less than 2 mA for 5 seconds). Poor contact on the signal connection at the terminals.
A1414: Slot D AI2 cable disconnection	Analog input signal set to actual mode is out of the range 4 to 20 mA.	- AI cable broken (the read value was less than 2 mA for 5 seconds). Poor contact on the signal connection at the terminals.
F1415: Slot D AI2 cable disconnection	Analog input signal set to actual mode is out of the range 4 to 20 mA.	- AI cable broken (the read value was less than 2 mA for 5 seconds). Poor contact on the signal connection at the terminals.
A1416: Slot D AI3 cable disconnection	Analog input signal set to actual mode is out of the range 4 to 20 mA.	- AI cable broken (the read value was less than 2 mA for 5 seconds). Poor contact on the signal connection at the terminals.

Protection/Alarm	Description	Possible causes
F1417: Slot D AI3 cable disconnection	Analog input signal set to actual mode is out of the range 4 to 20 mA.	- AI cable broken (the read value was less than 2 mA for 5 seconds). Poor contact on the signal connection at the terminals.
A1418: Slot D AI4 cable disconnection	Analog input signal set to actual mode is out of the range 4 to 20 mA.	- AI cable broken (the read value was less than 2 mA for 5 seconds). Poor contact on the signal connection at the terminals.
F1419: Slot D AI4 cable disconnection	Analog input signal set to actual mode is out of the range 4 to 20 mA.	- AI cable broken (the read value was less than 2 mA for 5 seconds). Poor contact on the signal connection at the terminals.
F1425: Slot D temp. sensor wrong hw config.	Sensor type selected by the accessory DIP switches other than the sensor type configured by the parameters.	- DIP switch configured incorrectly. Check the CFW900-TEMP-01 accessory guide. - "Sensor Type" parameter incorrectly configured. Check the description in C5.2.6.1.
A1426: Slot D temperature sensor 1 error	Value measured by the temperature sensor out of the expected range.	- Sensor cable is broken. - Short-circuited sensor. - Sensor located in an extremely low temperature environment.
F1427: Slot D temperature sensor 1 error	Value measured by the temperature sensor out of the expected range.	- Sensor cable is broken. - Short-circuited sensor. - Sensor located in an extremely low temperature environment.
A1428: Slot D high temperature in sensor 1	Temperature measured by the sensor close to the threshold level.	- Monitored equipment at a high temperature. - Fault actuation level configuration error.
F1429: Slot D sensor 1 overtemperature	Temperature measured by the sensor close to the threshold level.	- Monitored equipment at a high temperature. - Fault actuation level configuration error.
A1430: Slot D temperature sensor 2 error	Value measured by the temperature sensor out of the expected range.	- Sensor cable is broken. - Short-circuited sensor. - Sensor located in an extremely low temperature environment.
F1431: Slot D temperature sensor 2 error	Value measured by the temperature sensor out of the expected range.	- Sensor cable is broken. - Short-circuited sensor. - Sensor located in an extremely low temperature environment.
A1432: Slot D high temperature in sensor 2	Temperature measured by the sensor close to the threshold level.	- Monitored equipment at a high temperature. - Fault actuation level configuration error.
F1433: Slot D sensor 2 overtemperature	Temperature measured by the sensor close to the threshold level.	- Monitored equipment at a high temperature. - Fault actuation level configuration error.
A1434: Slot D temperature sensor 3 error	Value measured by the temperature sensor out of the expected range.	- Sensor cable is broken. - Short-circuited sensor. - Sensor located in an extremely low temperature environment.
F1435: Slot D temperature sensor 3 error	Value measured by the temperature sensor out of the expected range.	- Sensor cable is broken. - Short-circuited sensor. - Sensor located in an extremely low temperature environment.
A1436: Slot D high temperature in sensor 3	Temperature measured by the sensor close to the threshold level.	- Monitored equipment at a high temperature. - Fault actuation level configuration error.

Protection/Alarm	Description	Possible causes
F1437: Slot D sensor 3 overtemperature	Temperature measured by the sensor close to the threshold level.	- Monitored equipment at a high temperature. - Fault actuation level configuration error.
A1438: Slot D temperature sensor 4 error	Value measured by the temperature sensor out of the expected range.	- Sensor cable is broken. - Short-circuited sensor. - Sensor located in an extremely low temperature environment.
F1439: Slot D temperature sensor 4 error	Value measured by the temperature sensor out of the expected range.	- Sensor cable is broken. - Short-circuited sensor. - Sensor located in an extremely low temperature environment.
A1440: Slot D high temperature in sensor 4	Temperature measured by the sensor close to the threshold level.	- Monitored equipment at a high temperature. - Fault actuation level configuration error.
F1441: Slot D sensor 4 overtemperature	Temperature measured by the sensor close to the threshold level.	- Monitored equipment at a high temperature. - Fault actuation level configuration error.
A1442: Slot D temperature sensor 5 error	Value measured by the temperature sensor out of the expected range.	- Sensor cable is broken. - Short-circuited sensor. - Sensor located in an extremely low temperature environment.
F1443: Slot D temperature sensor 5 error	Value measured by the temperature sensor out of the expected range.	- Sensor cable is broken. - Short-circuited sensor. - Sensor located in an extremely low temperature environment.
A1444: Slot D high temperature in sensor 5	Temperature measured by the sensor close to the threshold level.	- Monitored equipment at a high temperature. - Fault actuation level configuration error.
F1445: Slot D sensor 5 overtemperature	Temperature measured by the sensor close to the threshold level.	- Monitored equipment at a high temperature. - Fault actuation level configuration error.
A1446: Slot D temperature sensor 6 error	Value measured by the temperature sensor out of the expected range.	- Sensor cable is broken. - Short-circuited sensor. - Sensor located in an extremely low temperature environment.
F1447: Slot D temperature sensor 6 error	Value measured by the temperature sensor out of the expected range.	- Sensor cable is broken. - Short-circuited sensor. - Sensor located in an extremely low temperature environment.
A1448: Slot D high temperature in sensor 6	Temperature measured by the sensor close to the threshold level.	- Monitored equipment at a high temperature. - Fault actuation level configuration error.
F1449: Slot D sensor 6 overtemperature	Temperature measured by the sensor close to the threshold level.	- Monitored equipment at a high temperature. - Fault actuation level configuration error.
F1500: Slot E incompatible accessory	Error during accessory firmware update.	Old inverter firmware version.
F1501: Slot E Initialization Error	It was not possible to initialize a resource required for the accessory to work.	- Resource already in use by another accessory. In the case of communication network accessories, only one accessory of each type of network can be connected to the inverter at a time.
F1503: Slot E accessory connection	Loss of communication with the accessory.	- Above-supported electromagnetic noise. - Vibration above supported limits causing connector problems. - Corrupted accessory firmware.

Protection/Alarm	Description	Possible causes
A1504: Slot E high temperature	Temperature in the accessory is high.	- Temperature around the inverter close to 60 °C.
F1505: Slot E overtemperature	Accessory overtemperature.	- Temperature around the inverter above 60 °C.
A1506: Slot E enc. A cable disconnection	Encoder signal not detected correctly Note: It can be disabled by setting C5.n.6.2, where n is the number of the slot where the accessory is installed.	- Broken or disconnected signal cable. - Encoder connection error. - Encoder without power supply.
F1507: Slot E enc. A cable disconnection	Encoder signal not detected correctly Note: It can be disabled by setting C5.n.6.2, where n is the number of the slot where the accessory is installed.	- Broken or disconnected signal cable. - Encoder connection error. - Encoder without power supply.
A1508: Slot E enc. B cable disconnection	Encoder signal not detected correctly Note: It can be disabled by setting C5.n.6.2, where n is the number of the slot where the accessory is installed.	- Broken or disconnected signal cable. - Encoder connection error. - Encoder without power supply.
F1509: Slot E enc. B cable disconnection	Encoder signal not detected correctly Note: It can be disabled by setting C5.n.6.2, where n is the number of the slot where the accessory is installed.	- Broken or disconnected signal cable. - Encoder connection error. - Encoder without power supply.
A1510: Slot E enc. Z cable disconnection	Encoder signal Z not detected correctly	- Broken or disconnected signal cable. - Encoder connection error. - Encoder without power supply.
F1511: Slot E enc. Z cable disconnection	Encoder signal Z not detected correctly	- Broken or disconnected signal cable. - Encoder connection error. - Encoder without power supply.
A1512: Slot E AI1 cable disconnection	Analog input signal set to actual mode is out of the range 4 to 20 mA.	- AI cable broken (the read value was less than 2 mA for 5 seconds). Poor contact on the signal connection at the terminals.
F1513: Slot E AI1 cable disconnection	Analog input signal set to actual mode is out of the range 4 to 20 mA.	- AI cable broken (the read value was less than 2 mA for 5 seconds). Poor contact on the signal connection at the terminals.
A1514: Slot E AI2 cable disconnection	Analog input signal set to actual mode is out of the range 4 to 20 mA.	- AI cable broken (the read value was less than 2 mA for 5 seconds). Poor contact on the signal connection at the terminals.
F1515: Slot E AI2 cable disconnection	Analog input signal set to actual mode is out of the range 4 to 20 mA.	- AI cable broken (the read value was less than 2 mA for 5 seconds). Poor contact on the signal connection at the terminals.
A1516: Slot E AI3 cable disconnection	Analog input signal set to actual mode is out of the range 4 to 20 mA.	- AI cable broken (the read value was less than 2 mA for 5 seconds). Poor contact on the signal connection at the terminals.

Protection/Alarm	Description	Possible causes
F1517: Slot E AI3 cable disconnection	Analog input signal set to actual mode is out of the range 4 to 20 mA.	- AI cable broken (the read value was less than 2 mA for 5 seconds). Poor contact on the signal connection at the terminals.
A1518: Slot E AI4 cable disconnection	Analog input signal set to actual mode is out of the range 4 to 20 mA.	- AI cable broken (the read value was less than 2 mA for 5 seconds). Poor contact on the signal connection at the terminals.
F1519: Slot E AI4 cable disconnection	Analog input signal set to actual mode is out of the range 4 to 20 mA.	- AI cable broken (the read value was less than 2 mA for 5 seconds). Poor contact on the signal connection at the terminals.
F1525: Slot E temp. sensor wrong hw config.	Sensor type selected by the accessory DIP switches other than the sensor type configured by the parameters.	- DIP switch configured incorrectly. Check the CFW900-TEMP-01 accessory guide. - "Sensor Type" parameter incorrectly configured. Check the description in C5.2.6.1.
A1526: Slot E temperature sensor 1 error	Value measured by the temperature sensor out of the expected range.	- Sensor cable is broken. - Short-circuited sensor. - Sensor located in an extremely low temperature environment.
F1527: Slot E temperature sensor 1 error	Value measured by the temperature sensor out of the expected range.	- Sensor cable is broken. - Short-circuited sensor. - Sensor located in an extremely low temperature environment.
A1528: Slot E high temperature in sensor 1	Temperature measured by the sensor close to the threshold level.	- Monitored equipment at a high temperature. - Fault actuation level configuration error.
F1529: Slot E sensor 1 overtemperature	Temperature measured by the sensor close to the threshold level.	- Monitored equipment at a high temperature. - Fault actuation level configuration error.
A1530: Slot E temperature sensor 2 error	Value measured by the temperature sensor out of the expected range.	- Sensor cable is broken. - Short-circuited sensor. - Sensor located in an extremely low temperature environment.
F1531: Slot E temperature sensor 2 error	Value measured by the temperature sensor out of the expected range.	- Sensor cable is broken. - Short-circuited sensor. - Sensor located in an extremely low temperature environment.
A1532: Slot E high temperature in sensor 2	Temperature measured by the sensor close to the threshold level.	- Monitored equipment at a high temperature. - Fault actuation level configuration error.
F1533: Slot E sensor 2 overtemperature	Temperature measured by the sensor close to the threshold level.	- Monitored equipment at a high temperature. - Fault actuation level configuration error.
A1534: Slot E temperature sensor 3 error	Value measured by the temperature sensor out of the expected range.	- Sensor cable is broken. - Short-circuited sensor. - Sensor located in an extremely low temperature environment.
F1535: Slot E temperature sensor 3 error	Value measured by the temperature sensor out of the expected range.	- Sensor cable is broken. - Short-circuited sensor. - Sensor located in an extremely low temperature environment.
A1536: Slot E high temperature in sensor 3	Temperature measured by the sensor close to the threshold level.	- Monitored equipment at a high temperature. - Fault actuation level configuration error.

Protection/Alarm	Description	Possible causes
F1537: Slot E sensor 3 overtemperature	Temperature measured by the sensor close to the threshold level.	<ul style="list-style-type: none"> - Monitored equipment at a high temperature. - Fault actuation level configuration error.
A1538: Slot E temperature sensor 4 error	Value measured by the temperature sensor out of the expected range.	<ul style="list-style-type: none"> - Sensor cable is broken. - Short-circuited sensor. - Sensor located in an extremely low temperature environment.
F1539: Slot E temperature sensor 4 error	Value measured by the temperature sensor out of the expected range.	<ul style="list-style-type: none"> - Sensor cable is broken. - Short-circuited sensor. - Sensor located in an extremely low temperature environment.
A1540: Slot E high temperature in sensor 4	Temperature measured by the sensor close to the threshold level.	<ul style="list-style-type: none"> - Monitored equipment at a high temperature. - Fault actuation level configuration error.
F1541: Slot E sensor 4 overtemperature	Temperature measured by the sensor close to the threshold level.	<ul style="list-style-type: none"> - Monitored equipment at a high temperature. - Fault actuation level configuration error.
A1542: Slot E temperature sensor 5 error	Value measured by the temperature sensor out of the expected range.	<ul style="list-style-type: none"> - Sensor cable is broken. - Short-circuited sensor. - Sensor located in an extremely low temperature environment.
F1543: Slot E temperature sensor 5 error	Value measured by the temperature sensor out of the expected range.	<ul style="list-style-type: none"> - Sensor cable is broken. - Short-circuited sensor. - Sensor located in an extremely low temperature environment.
A1544: Slot E high temperature in sensor 5	Temperature measured by the sensor close to the threshold level.	<ul style="list-style-type: none"> - Monitored equipment at a high temperature. - Fault actuation level configuration error.
F1545: Slot E sensor 5 overtemperature	Temperature measured by the sensor close to the threshold level.	<ul style="list-style-type: none"> - Monitored equipment at a high temperature. - Fault actuation level configuration error.
A1546: Slot E temperature sensor 6 error	Value measured by the temperature sensor out of the expected range.	<ul style="list-style-type: none"> - Sensor cable is broken. - Short-circuited sensor. - Sensor located in an extremely low temperature environment.
F1547: Slot E temperature sensor 6 error	Value measured by the temperature sensor out of the expected range.	<ul style="list-style-type: none"> - Sensor cable is broken. - Short-circuited sensor. - Sensor located in an extremely low temperature environment.
A1548: Slot E high temperature in sensor 6	Temperature measured by the sensor close to the threshold level.	<ul style="list-style-type: none"> - Monitored equipment at a high temperature. - Fault actuation level configuration error.
F1549: Slot E sensor 6 overtemperature	Temperature measured by the sensor close to the threshold level.	<ul style="list-style-type: none"> - Monitored equipment at a high temperature. - Fault actuation level configuration error.
F1600: Slot F incompatible accessory	Error during accessory firmware update.	Old inverter firmware version.
F1601: Slot F Initialization Error	It was not possible to initialize a resource required for the accessory to work.	<ul style="list-style-type: none"> - Resource already in use by another accessory. In the case of communication network accessories, only one accessory of each type of network can be connected to the inverter at a time.
F1603: Slot F accessory connection	Loss of communication with the accessory.	<ul style="list-style-type: none"> - Above-supported electromagnetic noise. - Vibration above supported limits causing connector problems. - Corrupted accessory firmware.

Protection/Alarm	Description	Possible causes
A1604: Slot F high temperature	Temperature in the accessory is high.	- Temperature around the inverter close to 60 °C.
F1605: Slot F overtemperature	Accessory overtemperature.	- Temperature around the inverter above 60 °C.
A1606: Slot F enc. A cable disconnection	Encoder signal not detected correctly Note: It can be disabled by setting C5.n.6.2, where n is the number of the slot where the accessory is installed.	- Broken or disconnected signal cable. - Encoder connection error. - Encoder without power supply.
F1607: Slot F enc. A cable disconnection	Encoder signal not detected correctly Note: It can be disabled by setting C5.n.6.2, where n is the number of the slot where the accessory is installed.	- Broken or disconnected signal cable. - Encoder connection error. - Encoder without power supply.
A1608: Slot F enc. B cable disconnection	Encoder signal not detected correctly Note: It can be disabled by setting C5.n.6.2, where n is the number of the slot where the accessory is installed.	- Broken or disconnected signal cable. - Encoder connection error. - Encoder without power supply.
F1609: Slot F enc. B cable disconnection	Encoder signal not detected correctly Note: It can be disabled by setting C5.n.6.2, where n is the number of the slot where the accessory is installed.	- Broken or disconnected signal cable. - Encoder connection error. - Encoder without power supply.
A1610: Slot F enc. Z cable disconnection	Encoder signal Z not detected correctly	- Broken or disconnected signal cable. - Encoder connection error. - Encoder without power supply.
F1611: Slot F enc. Z cable disconnection	Encoder signal Z not detected correctly	- Broken or disconnected signal cable. - Encoder connection error. - Encoder without power supply.
A1612: Slot F AI1 cable disconnection	Analog input signal set to actual mode is out of the range 4 to 20 mA.	- AI cable broken (the read value was less than 2 mA for 5 seconds). Poor contact on the signal connection at the terminals.
F1613: Slot F AI1 cable disconnection	Analog input signal set to actual mode is out of the range 4 to 20 mA.	- AI cable broken (the read value was less than 2 mA for 5 seconds). Poor contact on the signal connection at the terminals.
A1614: Slot F AI2 cable disconnection	Analog input signal set to actual mode is out of the range 4 to 20 mA.	- AI cable broken (the read value was less than 2 mA for 5 seconds). Poor contact on the signal connection at the terminals.
F1615: Slot F AI2 cable disconnection	Analog input signal set to actual mode is out of the range 4 to 20 mA.	- AI cable broken (the read value was less than 2 mA for 5 seconds). Poor contact on the signal connection at the terminals.
A1616: Slot F AI3 cable disconnection	Analog input signal set to actual mode is out of the range 4 to 20 mA.	- AI cable broken (the read value was less than 2 mA for 5 seconds). Poor contact on the signal connection at the terminals.

Protection/Alarm	Description	Possible causes
F1617: Slot F AI3 cable disconnection	Analog input signal set to actual mode is out of the range 4 to 20 mA.	- AI cable broken (the read value was less than 2 mA for 5 seconds). Poor contact on the signal connection at the terminals.
A1618: Slot F AI4 cable disconnection	Analog input signal set to actual mode is out of the range 4 to 20 mA.	- AI cable broken (the read value was less than 2 mA for 5 seconds). Poor contact on the signal connection at the terminals.
F1619: Slot F AI4 cable disconnection	Analog input signal set to actual mode is out of the range 4 to 20 mA.	- AI cable broken (the read value was less than 2 mA for 5 seconds). Poor contact on the signal connection at the terminals.
F1625: Slot F temp. sensor wrong hw config.	Sensor type selected by the accessory DIP switches other than the sensor type configured by the parameters.	- DIP switch configured incorrectly. Check the CFW900-TEMP-01 accessory guide. - "Sensor Type" parameter incorrectly configured. Check the description in C5.2.6.1.
A1626: Slot F temperature sensor 1 error	Value measured by the temperature sensor out of the expected range.	- Sensor cable is broken. - Short-circuited sensor. - Sensor located in an extremely low temperature environment.
F1627: Slot F temperature sensor 1 error	Value measured by the temperature sensor out of the expected range.	- Sensor cable is broken. - Short-circuited sensor. - Sensor located in an extremely low temperature environment.
A1628: Slot F high temperature in sensor 1	Temperature measured by the sensor close to the threshold level.	- Monitored equipment at a high temperature. - Fault actuation level configuration error.
F1629: Slot F sensor 1 overtemperature	Temperature measured by the sensor close to the threshold level.	- Monitored equipment at a high temperature. - Fault actuation level configuration error.
A1630: Slot F temperature sensor 2 error	Value measured by the temperature sensor out of the expected range.	- Sensor cable is broken. - Short-circuited sensor. - Sensor located in an extremely low temperature environment.
F1631: Slot F temperature sensor 2 error	Value measured by the temperature sensor out of the expected range.	- Sensor cable is broken. - Short-circuited sensor. - Sensor located in an extremely low temperature environment.
A1632: Slot F high temperature in sensor 2	Temperature measured by the sensor close to the threshold level.	- Monitored equipment at a high temperature. - Fault actuation level configuration error.
F1633: Slot F sensor 2 overtemperature	Temperature measured by the sensor close to the threshold level.	- Monitored equipment at a high temperature. - Fault actuation level configuration error.
A1634: Slot F temperature sensor 3 error	Value measured by the temperature sensor out of the expected range.	- Sensor cable is broken. - Short-circuited sensor. - Sensor located in an extremely low temperature environment.
F1635: Slot F temperature sensor 3 error	Value measured by the temperature sensor out of the expected range.	- Sensor cable is broken. - Short-circuited sensor. - Sensor located in an extremely low temperature environment.
A1636: Slot F high temperature in sensor 3	Temperature measured by the sensor close to the threshold level.	- Monitored equipment at a high temperature. - Fault actuation level configuration error.

Protection/Alarm	Description	Possible causes
F1637: Slot F sensor 3 overtemperature	Temperature measured by the sensor close to the threshold level.	<ul style="list-style-type: none"> - Monitored equipment at a high temperature. - Fault actuation level configuration error.
A1638: Slot F temperature sensor 4 error	Value measured by the temperature sensor out of the expected range.	<ul style="list-style-type: none"> - Sensor cable is broken. - Short-circuited sensor. - Sensor located in an extremely low temperature environment.
F1639: Slot F temperature sensor 4 error	Value measured by the temperature sensor out of the expected range.	<ul style="list-style-type: none"> - Sensor cable is broken. - Short-circuited sensor. - Sensor located in an extremely low temperature environment.
A1640: Slot F high temperature in sensor 4	Temperature measured by the sensor close to the threshold level.	<ul style="list-style-type: none"> - Monitored equipment at a high temperature. - Fault actuation level configuration error.
F1641: Slot F sensor 4 overtemperature	Temperature measured by the sensor close to the threshold level.	<ul style="list-style-type: none"> - Monitored equipment at a high temperature. - Fault actuation level configuration error.
A1642: Slot F temperature sensor 5 error	Value measured by the temperature sensor out of the expected range.	<ul style="list-style-type: none"> - Sensor cable is broken. - Short-circuited sensor. - Sensor located in an extremely low temperature environment.
F1643: Slot F temperature sensor 5 error	Value measured by the temperature sensor out of the expected range.	<ul style="list-style-type: none"> - Sensor cable is broken. - Short-circuited sensor. - Sensor located in an extremely low temperature environment.
A1644: Slot F high temperature in sensor 5	Temperature measured by the sensor close to the threshold level.	<ul style="list-style-type: none"> - Monitored equipment at a high temperature. - Fault actuation level configuration error.
F1645: Slot F sensor 5 overtemperature	Temperature measured by the sensor close to the threshold level.	<ul style="list-style-type: none"> - Monitored equipment at a high temperature. - Fault actuation level configuration error.
A1646: Slot F temperature sensor 6 error	Value measured by the temperature sensor out of the expected range.	<ul style="list-style-type: none"> - Sensor cable is broken. - Short-circuited sensor. - Sensor located in an extremely low temperature environment.
F1647: Slot F temperature sensor 6 error	Value measured by the temperature sensor out of the expected range.	<ul style="list-style-type: none"> - Sensor cable is broken. - Short-circuited sensor. - Sensor located in an extremely low temperature environment.
A1648: Slot F high temperature in sensor 6	Temperature measured by the sensor close to the threshold level.	<ul style="list-style-type: none"> - Monitored equipment at a high temperature. - Fault actuation level configuration error.
F1649: Slot F sensor 6 overtemperature	Temperature measured by the sensor close to the threshold level.	<ul style="list-style-type: none"> - Monitored equipment at a high temperature. - Fault actuation level configuration error.
F1700: Slot G incompatible accessory	Error during accessory firmware update.	Old inverter firmware version.
F1701: Slot G Initialization Error	It was not possible to initialize a resource required for the accessory to work.	<ul style="list-style-type: none"> - Resource already in use by another accessory. In the case of communication network accessories, only one accessory of each type of network can be connected to the inverter at a time.
F1703: Slot G accessory connection	Loss of communication with the accessory.	<ul style="list-style-type: none"> - Above-supported electromagnetic noise. - Vibration above supported limits causing connector problems. - Corrupted accessory firmware.

Protection/Alarm	Description	Possible causes
A1704: Slot G high temperature	Temperature in the accessory is high.	- Temperature around the inverter close to 60 °C.
F1705: Slot G overtemperature	Accessory overtemperature.	- Temperature around the inverter above 60 °C.
A1706: Slot G enc. A cable disconnection	Encoder signal not detected correctly Note: It can be disabled by setting C5.n.6.2, where n is the number of the slot where the accessory is installed.	- Broken or disconnected signal cable. - Encoder connection error. - Encoder without power supply.
F1707: Slot G enc. A cable disconnection	Encoder signal not detected correctly Note: It can be disabled by setting C5.n.6.2, where n is the number of the slot where the accessory is installed.	- Broken or disconnected signal cable. - Encoder connection error. - Encoder without power supply.
A1708: Slot G enc. B cable disconnection	Encoder signal not detected correctly Note: It can be disabled by setting C5.n.6.2, where n is the number of the slot where the accessory is installed.	- Broken or disconnected signal cable. - Encoder connection error. - Encoder without power supply.
F1709: Slot G enc. B cable disconnection	Encoder signal not detected correctly Note: It can be disabled by setting C5.n.6.2, where n is the number of the slot where the accessory is installed.	- Broken or disconnected signal cable. - Encoder connection error. - Encoder without power supply.
A1710: Slot G enc. Z cable disconnection	Encoder signal Z not detected correctly	- Broken or disconnected signal cable. - Encoder connection error. - Encoder without power supply.
F1711: Slot G enc. Z cable disconnection	Encoder signal Z not detected correctly	- Broken or disconnected signal cable. - Encoder connection error. - Encoder without power supply.
A1712: Slot G AI1 cable disconnection	Analog input signal set to actual mode is out of the range 4 to 20 mA.	- AI cable broken (the read value was less than 2 mA for 5 seconds). Poor contact on the signal connection at the terminals.
F1713: Slot G AI1 cable disconnection	Analog input signal set to actual mode is out of the range 4 to 20 mA.	- AI cable broken (the read value was less than 2 mA for 5 seconds). Poor contact on the signal connection at the terminals.
A1714: Slot G AI2 cable disconnection	Analog input signal set to actual mode is out of the range 4 to 20 mA.	- AI cable broken (the read value was less than 2 mA for 5 seconds). Poor contact on the signal connection at the terminals.
F1715: Slot G AI2 cable disconnection	Analog input signal set to actual mode is out of the range 4 to 20 mA.	- AI cable broken (the read value was less than 2 mA for 5 seconds). Poor contact on the signal connection at the terminals.
A1716: Slot G AI3 cable disconnection	Analog input signal set to actual mode is out of the range 4 to 20 mA.	- AI cable broken (the read value was less than 2 mA for 5 seconds). Poor contact on the signal connection at the terminals.

Protection/Alarm	Description	Possible causes
F1717: Slot G AI3 cable disconnection	Analog input signal set to actual mode is out of the range 4 to 20 mA.	- AI cable broken (the read value was less than 2 mA for 5 seconds). Poor contact on the signal connection at the terminals.
A1718: Slot G AI4 cable disconnection	Analog input signal set to actual mode is out of the range 4 to 20 mA.	- AI cable broken (the read value was less than 2 mA for 5 seconds). Poor contact on the signal connection at the terminals.
F1719: Slot G AI4 cable disconnection	Analog input signal set to actual mode is out of the range 4 to 20 mA.	- AI cable broken (the read value was less than 2 mA for 5 seconds). Poor contact on the signal connection at the terminals.
F1725: Slot G temp. sensor wrong hw config.	Sensor type selected by the accessory DIP switches other than the sensor type configured by the parameters.	- DIP switch configured incorrectly. Check the CFW900-TEMP-01 accessory guide. - "Sensor Type" parameter incorrectly configured. Check the description in C5.2.6.1.
A1726: Slot G temperature sensor 1 error	Value measured by the temperature sensor out of the expected range.	- Sensor cable is broken. - Short-circuited sensor. - Sensor located in an extremely low temperature environment.
F1727: Slot G temperature sensor 1 error	Value measured by the temperature sensor out of the expected range.	- Sensor cable is broken. - Short-circuited sensor. - Sensor located in an extremely low temperature environment.
A1728: Slot G high temperature in sensor 1	Temperature measured by the sensor close to the threshold level.	- Monitored equipment at a high temperature. - Fault actuation level configuration error.
F1729: Slot G sensor 1 overtemperature	Temperature measured by the sensor close to the threshold level.	- Monitored equipment at a high temperature. - Fault actuation level configuration error.
A1730: Slot G temperature sensor 2 error	Value measured by the temperature sensor out of the expected range.	- Sensor cable is broken. - Short-circuited sensor. - Sensor located in an extremely low temperature environment.
F1731: Slot G temperature sensor 2 error	Value measured by the temperature sensor out of the expected range.	- Sensor cable is broken. - Short-circuited sensor. - Sensor located in an extremely low temperature environment.
A1732: Slot G high temperature in sensor 2	Temperature measured by the sensor close to the threshold level.	- Monitored equipment at a high temperature. - Fault actuation level configuration error.
F1733: Slot G sensor 2 overtemperature	Temperature measured by the sensor close to the threshold level.	- Monitored equipment at a high temperature. - Fault actuation level configuration error.
A1734: Slot G temperature sensor 3 error	Value measured by the temperature sensor out of the expected range.	- Sensor cable is broken. - Short-circuited sensor. - Sensor located in an extremely low temperature environment.
F1735: Slot G temperature sensor 3 error	Value measured by the temperature sensor out of the expected range.	- Sensor cable is broken. - Short-circuited sensor. - Sensor located in an extremely low temperature environment.
A1736: Slot G high temperature in sensor 3	Temperature measured by the sensor close to the threshold level.	- Monitored equipment at a high temperature. - Fault actuation level configuration error.

Protection/Alarm	Description	Possible causes
F1737: Slot G sensor 3 overtemperature	Temperature measured by the sensor close to the threshold level.	<ul style="list-style-type: none"> - Monitored equipment at a high temperature. - Fault actuation level configuration error.
A1738: Slot G temperature sensor 4 error	Value measured by the temperature sensor out of the expected range.	<ul style="list-style-type: none"> - Sensor cable is broken. - Short-circuited sensor. - Sensor located in an extremely low temperature environment.
F1739: Slot G temperature sensor 4 error	Value measured by the temperature sensor out of the expected range.	<ul style="list-style-type: none"> - Sensor cable is broken. - Short-circuited sensor. - Sensor located in an extremely low temperature environment.
A1740: Slot G high temperature in sensor 4	Temperature measured by the sensor close to the threshold level.	<ul style="list-style-type: none"> - Monitored equipment at a high temperature. - Fault actuation level configuration error.
F1741: Slot G sensor 4 overtemperature	Temperature measured by the sensor close to the threshold level.	<ul style="list-style-type: none"> - Monitored equipment at a high temperature. - Fault actuation level configuration error.
A1742: Slot G temperature sensor 5 error	Value measured by the temperature sensor out of the expected range.	<ul style="list-style-type: none"> - Sensor cable is broken. - Short-circuited sensor. - Sensor located in an extremely low temperature environment.
F1743: Slot G temperature sensor 5 error	Value measured by the temperature sensor out of the expected range.	<ul style="list-style-type: none"> - Sensor cable is broken. - Short-circuited sensor. - Sensor located in an extremely low temperature environment.
A1744: Slot G high temperature in sensor 5	Temperature measured by the sensor close to the threshold level.	<ul style="list-style-type: none"> - Monitored equipment at a high temperature. - Fault actuation level configuration error.
F1745: Slot G sensor 5 overtemperature	Temperature measured by the sensor close to the threshold level.	<ul style="list-style-type: none"> - Monitored equipment at a high temperature. - Fault actuation level configuration error.
A1746: Slot G temperature sensor 6 error	Value measured by the temperature sensor out of the expected range.	<ul style="list-style-type: none"> - Sensor cable is broken. - Short-circuited sensor. - Sensor located in an extremely low temperature environment.
F1747: Slot G temperature sensor 6 error	Value measured by the temperature sensor out of the expected range.	<ul style="list-style-type: none"> - Sensor cable is broken. - Short-circuited sensor. - Sensor located in an extremely low temperature environment.
A1748: Slot G high temperature in sensor 6	Temperature measured by the sensor close to the threshold level.	<ul style="list-style-type: none"> - Monitored equipment at a high temperature. - Fault actuation level configuration error.
F1749: Slot G sensor 6 overtemperature	Temperature measured by the sensor close to the threshold level.	<ul style="list-style-type: none"> - Monitored equipment at a high temperature. - Fault actuation level configuration error.

6.4 SOLUTIONS FOR THE MOST FREQUENT PROBLEMS

Table 6.2: Solutions for the most frequent problems

Problem	Point to be verified	Corrective Action
Motor does not start	Incorrect wiring connection	1. Check all power and control connections. For instance, the digital inputs set to Start/Stop, General Enable, or no external error shall be activated
	Analog reference (if used)	1. Check if the external signal is properly connected 2. Check the status of the control potentiometer (if used)
	Incorrect settings	1. Check if parameters are properly set for the application
	Fault	1. Check if the inverter is not blocked due to a fault condition 2. Check if there is a short circuit between the terminals of the 24 Vdc power supply
	Motor stall	1. Decrease motor overload Increase C3.2.1.1 (V/F) or C3.3.5.1.2, C3.3.5.1.3, C3.3.5.1.4 and C3.3.5.1.5 (vector control)
Motor speed fluctuates (oscillates)	Loose connection	1. Stop the inverter, turn off the power supply, and check and tighten all power connections 2. Check all internal connections of the inverter
	Defective reference potentiometer	1. Replace potentiometer
	Oscillation of the external analog reference	1. Identify the cause of the oscillation. If it is caused by electrical noise, use shielded cables or separate from the power and control wiring
	Incorrect settings (vector control)	1. Check parameters C2.2.2 and C2.2.4 2. Refer to the programming manual
Motor speed too high or too low	Incorrect settings (reference limits)	1. Check if the content of C4.3.1.1.1 (minimum speed) and C4.3.1.1.2 (maximum speed) are according to the motor and application
	Control signal from the analog reference (if used)	1. Check the level of the reference control signal 2. Check the programming gains and offset
	Motor nameplate	1. Check if the motor has been properly sized for the application
Motor does not operate in the field weakening region (Vector Control)	Settings	1. Check C2.2.2 e C3.3.7.1
Off display	Keypad connections	1. Check the inverter keypad connection
	Power supply voltage	1. Rated values shall be within the limits specified below: 200-240 Vca power supply: - Min: 187 Vca - Max: 253 Vca 380-480 Vca power supply: - Min: 323 Vca - Max: 528 Vca
	Blown fuses	1. Replace fuses
Low motor speed and S1.1.4 = C3.3.5.1.2 ou C3.3.5.1.3 ou C3.3.5.1.4 ou C3.3.5.1.5 (motor in torque limitation), for C3.1.1 = 2 (vector with encoder)	Encoder signals are inverted or power connection is inverted	1. Check if the signals A , \bar{A} , B , \bar{B} are correctly connected to the CFW900-IOS (item 3.2.6) or to the accessory of inputs for incremental encoder (see the CFW900-ENC-01 manual). If signals are properly installed, exchange two of the output phases. For instance U and V.

6.5 INFORMATION FOR CONTACTING TECHNICAL SUPPORT

For technical support and servicing, it is important to have the following information in hand:

- Inverter model.
- Product serial number and manufacturing date contained in the identification label (see [Section 2.3.1](#)).
- Installed software version (see parameter S1.2.1).
- Application data and inverter settings.

6.6 PREVENTIVE MAINTENANCE

DANGER!

- Always turn off the mains power supply before touching any electrical component associated to the inverter.
- High voltage may still be present even after disconnecting the power supply. Therefore, wait at least 10 minutes for the complete discharge of the power capacitors.
- Always connect the equipment frame to the protection earth (PE) at the suitable connection point.

WARNING!

The electronic boards have electrostatic discharge sensitive components. Do not touch the components or connectors directly. If needed, first touch the grounded metallic frame or wear a ground strap.
Do not perform any withstand voltage test: if needed, consult WEG.

The inverters require low maintenance when properly installed and operated. [Table 6.3](#) presents main procedures and time intervals for preventive maintenance. [Table 6.4](#) provides recommended periodic inspections to be performed every 6 months after inverter start-up.

Table 6.3: Preventive maintenance

Maintenance		Interval	Instructions
Fan replacement		After 50.000 operating hours ⁽¹⁾	Replacement procedure according to Figure 6.1 and Figure 6.2 .
Replacement of the AUI board battery		Every 10 years	Refer to Chapter 3
Electrolytic Capacitors	If the inverter is stored (not in use): "reforming"	Every year, counted from the manufacturing date stated on the inverter identification label. Section 2.3.1)	Power inverter with single-phase or three-phase voltage between 208 and 240 Vac, 50 or 60 Hz, for at least 1 hour. Then, de-energize and wait at least 24 hours before using the inverter (energize again)
	Inverter is being used: replace	Every 10 years	Contact WEG technical support

⁽¹⁾ The inverters are programmed at the factory for automatic control of the fans (C1.5.1 = 3), so they only start when the temperature of the heatsink increases. Therefore, the number of operating hours of the fans will depend on the operating conditions (motor current, output frequency, temperature of the cooling air etc.). The inverter records in parameter D3.3 the number of hours that the fan remained ON. When the fan reaches 50,000 hours of operation, the HMI will display alarm A177.

Table 6.4: Recommended periodic inspections - every 6 months

Component	Problem	Corrective Action
Terminals, connectors	Loose screws	Tighten
	Loose connectors	
Fans/cooling system	Dirty fans	Cleaning
	Abnormal noise	Replace fan. Refer to Figure 6.1 and Figure 6.2 .
	Blocked fan	Proceed in reverse order to assemble a new fan Check the fan connection
	Abnormal vibration	
	Dust in the cabinet air filter	
Printed circuit boards	Accumulation of dust, oil, humidity, etc	Cleaning
	Odor	Replacement
Power module/power connections	Accumulation of dust, oil, humidity, etc	Cleaning
	Loose connection screws	Tighten
DC Link capacitors (Intermediate Circuit)	Discoloration/ odor / electrolyte leakage	Replacement
	Expanded or broken safety valve	
	Frame expansion	
Power resistors	Discoloration	Replacement
	Odor	
Heatsink	Dust accumulation	Cleaning
	Dirty	

6.7 CLEANING INSTRUCTIONS

When necessary to clean the inverter, follow the instructions:

Ventilation system:

- Disconnect the inverter power supply and wait at least 10 minutes.
- Remove the dust accumulated in the ventilation opening using a plastic brush or a flannel.
- Remove the dust accumulated on the fan blades using compressed air.

Electronic boards:

- Disconnect the inverter power supply and wait at least 10 minutes.
- Remove the plastic cover, as shown in [Chapter 3](#).
- Remove the dust from the electronic board by using an anti-static brush or an ion air gun.
- Always wear a ground strap.

To remove and reinstall the fan, follow the steps shown in [Figure 6.1](#) and [Figure 6.2](#).

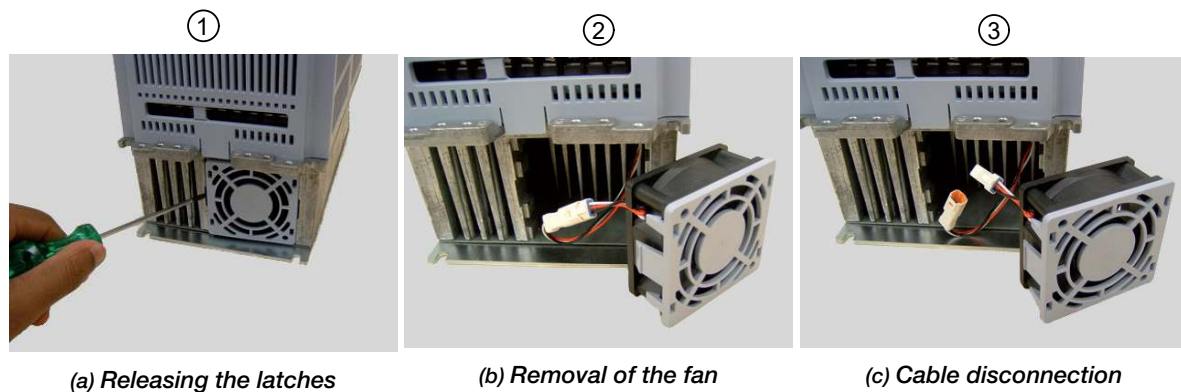

Figure 6.1: Removing the heatsink fan

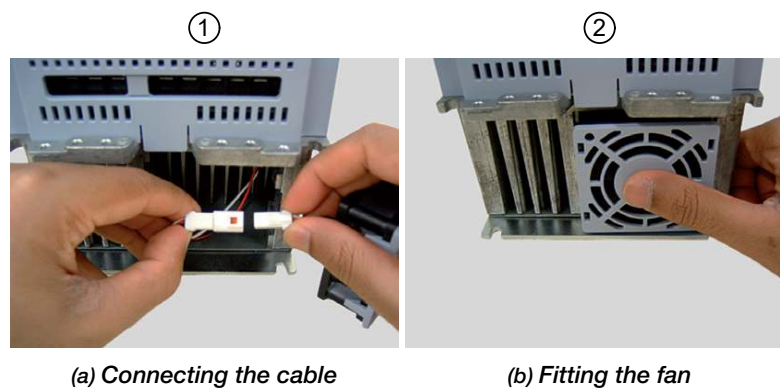

Figure 6.2: Installing the fan

7 ACCESSORIES

7.1 LIST OF ACCESSORIES

Accessories is hardware that can be added to the inverter to expand the product application possibilities. Thus, all models of the CFW900 line can be equipped with the accessories listed in ut and are interchangeable between all frames, except for the protection rating kits (UL type 1 and IP21).

Table 7.1: Accessories available

WEG Item	Name	Description	Slots taken
Control accessories for installation in slots A through G⁽¹⁾			
15691379	CFW900-CCAN-W ⁽²⁾	CAN interface module (CANopen / DeviceNet)	1
15691256	CFW900-ENC-01	Module for connecting an incremental encoder with a signal of up to 310 kHz	1
15691117	CFW900-IOAI-01	Module with 3 analog inputs and 2 isolated analog outputs	1
15691249	CFW900-IOD-01	Module with 8 isolated digital inputs and 8 isolated digital outputs	1
15691251	CFW900-REL-01	Module with 3 digital relay outputs (1 unit supplied as standard)	1
15691253	CFW900-TEMP-01	Module with 6 isolated inputs for PTC/PT100/PT1000 sensors	1
Individual HMI, frame and cables for external HMI			
15691113	CFW900-HMI-BLT	HMI with Bluetooth interface (Individual item) (standard for option B) ⁽³⁾	
15690771	CFW900-HMI	HMI (Individual) ⁽³⁾	
15756246	CFW900-RHMIF	Frame kit for remote HMI (IP65 / UL Type 12 protection rating)	
15692985	CFW900-CCHMIR01M	Serial cable for remote HMI 1 m	
15693038	CFW900-CCHMIR02M	Serial cable for remote HMI 2 m	
15693040	CFW900-CCHMIR03M	Serial cable for remote HMI 3 m	
15693042	CFW900-CCHMIR05M	Serial cable for remote HMI 5 m	
15693044	CFW900-CCHMIR07M	Serial cable for remote HMI 7.5 m	
15693045	CFW900-CCHMIR10M	Serial cable for remote HMI 10 m	
Miscellaneous			
15692737	CFW900-4SLOTS	Backplane with 4 slots (A through D) to connect accessories (supplied as standard)	
15692736	CFW900-7SLOTS	Backplane with 7 slots (A through G) to connect accessories	
15756311	CFW900-KN1A	Nema1 kit for frame A ⁽⁴⁾	
15757498	CFW900-KN1B	Nema1 kit for frame B ⁽⁴⁾	
15757502	CFW900-KN1C	Nema1 kit for frame C ⁽⁴⁾	
15757538	CFW900-KN1D	Nema1 kit for frame D ⁽⁴⁾	
15757540	CFW900-KN1E	Nema1 kit for frame E ⁽⁴⁾	
16240897	CFW900-IP21A	IP21 kit for frame A ⁽⁵⁾	
16241128	CFW900-IP21B	IP21 kit for frame B ⁽⁵⁾	
16241129	CFW900-IP21C	IP21 kit for frame C ⁽⁵⁾	
16241130	CFW900-IP21D	IP21 kit for frame D ⁽⁵⁾	
15757541	CFW900-IP21E	IP21 kit for frame E ⁽⁵⁾	
16352814	CFW900-SDC	8GB industrial temperature microSD card	

⁽¹⁾ Control accessories can be installed in any available slot. Except for explicitly listed cases, up to 7 accessories of the same type can be used.

⁽²⁾ It is only possible to use one CFW900-CCAN-W communication module per inverter.

⁽³⁾ For remote HMI connection, use a D-Sub9 (DB-9) male and female cable with pin-to-pin connections. Maximum length according to Table 8.10.

⁽⁴⁾ For more details see items 8.4.8 and 8.4.9.

⁽⁵⁾ For more details see items 8.4.6 and 8.4.7.

Table 7.2: Consumption of the accessories

Model	Consumption ($I_{ACC,n}$) ⁽¹⁾
CFW900-CCAN-W	0.00A
CFW900-ENC-01	0.20A
CFW900-IOAI-01	0.10A
CFW900-IOD-01	0.00A
CFW900-REL-01	0.05A
CFW900-TEMP-01	0.05A

⁽¹⁾ "n" indicates the slot to which the accessory will be connected.

7.2 BACKPLANE REPLACEMENT

The control accessories are mounted in the **backplane** slots. The slots are interchangeable, and any accessory can be mounted in any slot in any quantity (except for communication network accessories, which are limited to one per drive). By default, the CFW900 is supplied with the **backplane** CFW900-4SLOTS, which allows the installation of up to 4 accessories (slots A to D). It is possible to replace the CFW900-4SLOTS with the CFW900-7SLOTS, which expands the connection up to 7 accessories, following the steps in [Figure 7.1](#).

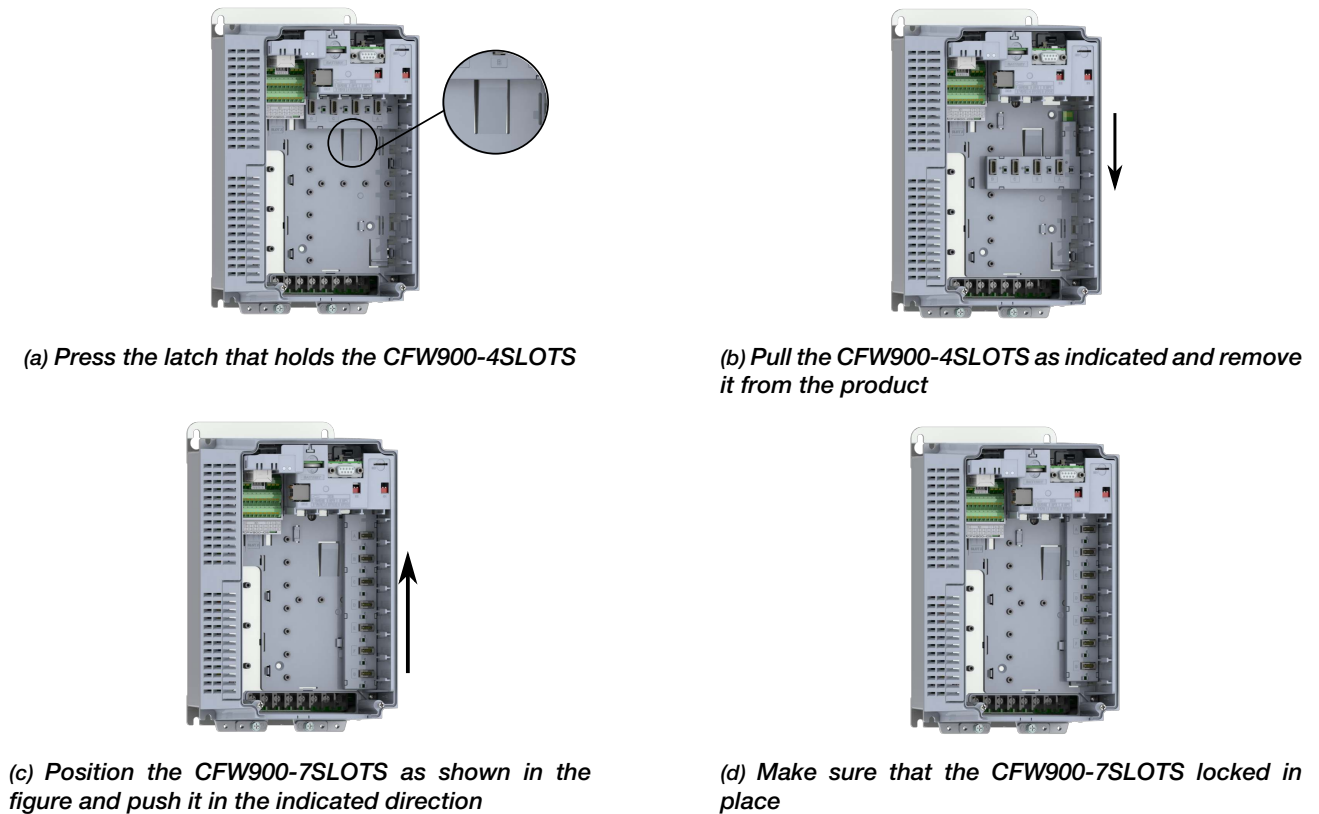

Figure 7.1: Replacing the CFW900-4SLOTS with the CFW900-7SLOTS

7.3 INSTALLING THE CONTROL ACCESSORY

The control accessories are easy and quickly installed on the inverters using the plug-and-play concept. They may be ordered separately and will be shipped in individual packages containing the components and the manuals with detailed instructions for the product operation and programming. When an accessory is connected to the inverter, the control circuitry identifies the model and informs the code of the connected accessory. They should only be installed or changed with the inverter turned off, following the steps presented below and exemplified in [Figure 7.2](#).

1. Remove the HMI from the inverter front.
2. Remove the two screws and detach the front cover.
3. Insert the accessory into one of the available slots on the backplane. (A)
4. Fasten the grounding screw. (B)
5. Make the connections to the plug-in connector and plug it into the accessory. (C)
6. Connect the cable shield to the grounding plate using metal clamps. (D)
7. Attach the identification labels (supplied with the backplane) to the accessory and to the plug-in connector. (E)
8. Put the front cover and HMI back in place.

9. Power up the CFW900 and check that the accessory has been correctly identified in parameter S1.4.n.1, where 'n' indicates the slot to which the accessory has been connected.

English

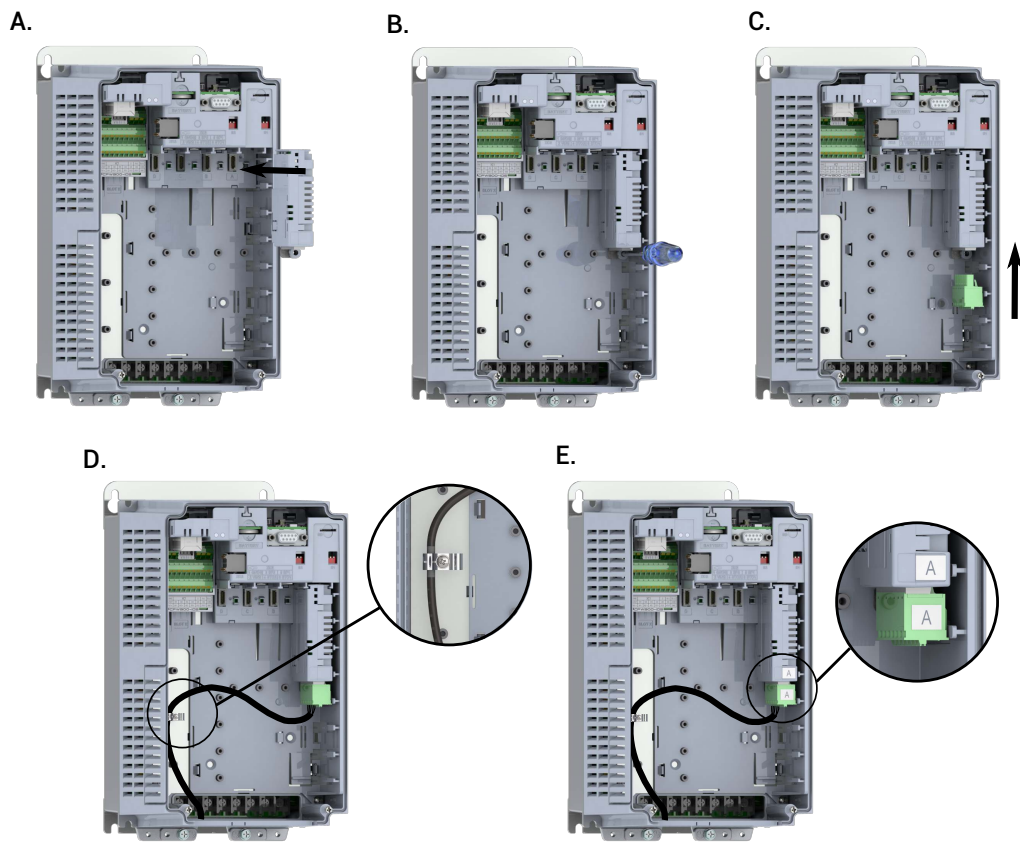

Figure 7.2: Installing the accessory

8 TECHNICAL SPECIFICATIONS

8.1 INVERTER POWER DATA

8.1.1 Input

Table 8.1: Inverter Input Data

Inverter smart code - items "IV" and "V" Suffix number of phases and rated voltage	B2	T2	T4
AC Power Supply			
Number of phases (input)	1 or 3	3	3
Rated input voltage	200 ... 240 Vrms	Frames A, B and C: 200...240 Vrms Frames D and E: 208...240 Vrms	380...480 Vrms
Input voltage tolerance	-15% +10%	Frame A, B and C: -15%+10% Frames D and E: -15% +10% ⁽¹⁾	-15% +10%
Input frequency	50/60 Hz (range: 48 ... 63 Hz)		
Phase unbalance	≤3% between line voltages		
Overvoltages / transients	Category III (EN 61010 / IEC61800-5-1 / UL61800-5-1)		
Input rated current			
-Three-phase power supply	1.1 x I _{o,nom}	I _{o,nom}	I _{o,nom}
-Single-phase power supply	2.06 x I _{o,nom}	-	-
Inverter power factor for rated condition ND ⁽²⁾			
-Three-phase power supply	0.77	0.93	0.93
-Single-phase power supply	0.70	-	-
Inverter displacement factor (cos phi)	≥0.98		
Harmonic distortion of the input current (THDi)	≤ 42% for 75 to 100% of I _{o,nom} ⁽³⁾		
Maximum number of powerups (network connections)	Maximum 1 per minute		
Types of power supply ⁽⁴⁾	Frame Size A: TT / TN / IT (Except grounded by resistor) - slash voltage Frame Sizes B, C, D, E: TT / TN / IT / Delta earthed - straight voltage		
Efficiency (Efficiency class) ⁽⁵⁾	IE2 (IEC61800-9-2 / EN50598-2)		
DC power supply ^{(6) (7)}			
Input voltage range	229...400 Vcc	Frames A, B and C: 229...400 Vdc Frames D and E: 252...400 Vdc	436...800 Vdc
Input rated current	1.15x I _{o,nom}		

⁽¹⁾ For input voltage in the range $208 \leq V_{in} < 220$ Vrms the negative tolerance is -10%.

⁽²⁾ For the inverter input THDi values, please contact WEG.

⁽³⁾ Typical value. Valid only for balanced power supplies.

⁽⁴⁾ For operation on IT networks or networks grounded by high impedance, follow the grounding guidelines of [Section 3.2.4.1](#).

⁽⁵⁾ Efficiency levels by model can be found in the "WEG Ecodrive" app available for Android and iOS devices.

⁽⁶⁾ For DC power supply, an external pre-charge circuit must be used. Exception: in CFW900 inverters with frames A, B and C, it is possible to connect the "+" terminal of the DC power supply to the DC+ terminal and the "-" terminal to the R/L1/L and S/L2/N terminals. In this case, it is not necessary to use an external pre-charge.

⁽⁷⁾ For applications with common DC link, please consult WEG.

8.1.2 Output
Table 8.2: Inverter Output Data

Inverter smart code - items "IV" and "V" Suffix number of phases and rated voltage	B2	T2	T4
Inverter output			
Output voltage			
-Single-phase AC power supply	0 ... $V_{in} - 5\%$		
-Three-phase AC power supply	0 ... $V_{in} - 2\%$		
-Power Supply CC	0 ... $V_{dc} / 1.38$		
Output frequency	0 to 500 Hz for frame A...D ⁽¹⁾ 0 to 250 Hz for frame E ⁽¹⁾		
Rated output current	$I_{o,nom}$ (according to Tables 8.5, 8.6, 8.7 and 8.8)		
Switching frequency			
Rated ($f_{sw,nom}$) ⁽²⁾	4 kHz	Frames A...D: 4 kHz Frame E: 2 kHz	
Adjustment range ($f_{sw,usu}$) ⁽³⁾⁽⁴⁾	1...16 kHz	Frames A...D: 1.5...16 kHz Frame E: 1...8 kHz	
Maximum motor cable length			
-No need to use output reactance	200 m (over 100 m it is necessary to use PWM modulation for long cables) ⁽⁵⁾		
-With output reactance	500 m		
-With sinusoidal filter on the inverter output	5000 m		
Motor cable length to meet IEC61800-3:2017 standard	0 ... 200 m (shielded according to IEC60034-25)		

⁽¹⁾ This output frequency range is valid considering the factory settings (e.g., rated switching frequency). It is possible to operate with higher output frequencies, limited to 1000 Hz, but the rated switching frequency must be increased. In these cases, WEG must be consulted.

⁽²⁾ The switching frequency can be automatically reduced due to inverter output overload, high ambient temperature, obstruction of air circulation around the heatsink and/or operation with low output frequency.

⁽³⁾ For operation with a switching frequency above the rated switching frequency ($f_{sw,nom}$) it is necessary to reduce the output current according to [Figure 8.3](#).

⁽⁴⁾ Adjustable in 0.1 kHz steps.

⁽⁵⁾ The modulation type can be changed in parameter C1.4.1.

8.1.3 General Data
Table 8.3: Inverter General Data

Inverter smart code - items "IV" and "V" Suffix number of phases and rated voltage	B2	T2	T4
Dynamic Braking			
Braking IGBT ⁽¹⁾	Yes, included in the standard version	Frames A, B and C: yes, included in the standard version Frames D and E: optional, models with DB suffix	
RFI filter	Category C3, included in the standard version		

⁽¹⁾ The specifications for maximum braking current and minimum resistor resistance are indicated in [Table 3.8](#).

8.1.4 Environmental and Mechanical Data
Table 8.4: Inverter Environmental and Mechanical Data

Inverter smart code - item "II" Frame suffix (inverter cabinet size)	A	B	C	D	E
Maximum operating ambient temperature without output current derating					
-Back ⁽¹⁾⁽²⁾	50 °C (122 °F)	50 °C (122 °F)	50 °C (122 °F)	50 °C (122 °F)	45 °C (113 °F)
-Front ⁽³⁾	60 °C (140 °F)	60 °C (140 °F)	60 °C (140 °F) ⁽⁴⁾	60 °C (140 °F) ⁽⁴⁾	60 °C (140 °F)
Maximum operating temperature with output current derating					
-Back ⁽¹⁾⁽²⁾	60 °C (140 °F)				
-Front ⁽³⁾	60 °C (140 °F)				
Minimum operating ambient temperature					
-10 °C (14 °F)					
Humidity					
5 ... 95 % non-condensing					
Pollution degree					
2 (EN50178 / IEC61800-5-1 / UL61800-5-1)					
Degree of protection					
Back	IP55 / UL type 12				
Front:					
-Inverters with suffix "20"	IP20 / open chassis				
-Inverters with suffix "21" or inverters with suffix "20" with IP21 kit	IP21 / open chassis				
-Inverters with suffix "N1" or inverters with suffix "20" with UL type 1 kit	UL type 1				
HMI installed on metal panel using the CFW900-RHMIF kit	IP65 / UL type 12				
Altitude	Rated: 1000 m Maximum: 4000 m with derating factor				
Heatsink fan flow at the operation point					
CFM	20	40	130	190	270
l/s	9	19	61	90	127
m ³ /min	0.6	1.1	3.7	5.4	7.6
Wiring supported on the power terminals					
-min (mm ² /AWG)	0.5/20	0.5/20	0.5/20	Cable with M8 terminal maximum 24 mm wide	Cable with M10 terminal maximum 30 mm wide
-max (mm ² /AWG)	6/10	16/6	35/2		
Weight (kg / lb)	4.5 / 9.9	10.0 / 22.0	20.5 / 45.2	33.5 / 73.8	63.5 / 140.0
RoHS	Yes				
Conformal coating					
-Inverter in standard configuration	3C2 (IEC 60721-3-3:2002)				
-Inverter with suffix "HEC"	3C3 (IEC 60721-3-3:2002)				

⁽¹⁾ Heatsink air inlet temperature.

⁽²⁾ If the 2 parts of the inverter are in the same environment, this is the maximum temperature around the inverter.

⁽³⁾ If the 2 parts of the inverter are installed in different compartments (flange mounting), this is the maximum temperature around the front of the inverter.

⁽⁴⁾ Exception: models CFW900C74P0T4 and CFW900D0146T4 that have specification of 55 °C (131 °F). For operation above 55 °C it is necessary to apply derating of 2 %/°C.

8.1.5 Current, Motor and Loss Data
Table 8.5: Current, power and loss data for B2 and T2 lines and "ND" overload class

Inverter model	ND overload class: 110% for 60 seconds with a 5-minute interval 150% for 3 seconds with a 5-minute interval						Dissipated power for sizing the panel		Inverter loss data as per IEC61800-9-2 ⁽¹⁾	
	Rated output current	Typical motor ⁽²⁾							Inverter complete	Front part
		220V/60Hz	230V/50Hz	230V/60Hz	NEC Table 208V	NEC Table 230V	230V			
	Io,nom (ND) [Arms]	P,nom [CV]	P,nom [kW]	P,nom [hp]	P,nom [hp]	P,nom [hp]	PL(inv) [W]	PL(inv2) [W]	So [kVA]	pL(90,100) [%]
CFW900A04P6B2	4.6	1.5	1.1	1.5	1	1	81	34	1.8	4.4%
CFW900A06P0B2	6	2	1.5	2	1	1.5	96	39	2.4	4.1%
CFW900A07P5B2	7.5	2	1.5	3	2	2	109	41	3.0	3.7%
CFW900A10P0B2	10	3	2.2	3	2	3	127	46	4.0	3.2%
CFW900A04P6T2	4.6	1.5	1.1	1.5	1	1	70	30	1.8	3.9%
CFW900A06P0T2	6	2	1.5	2	1	1.5	84	32	2.4	3.5%
CFW900A07P5T2	7.5	2	1.5	3	2	2	92	34	3.0	3.1%
CFW900A10P6T2	10.6	3	3	3	3	3	111	36	4.2	2.7%
CFW900A13P0T2	13	4	3	5	3	3	130	39	5.2	2.5%
CFW900A19P0T2	19	6	5.5	7.5	5	5	168	45	7.6	2.3%
CFW900B26P0T2	26	10	7.5	10	7.5	7.5	251	64	10.4	2.5%
CFW900B34P0T2	34	12.5	9.2	10	10	10	315	75	13.5	2.4%
CFW900B45P0T2	45	15	11	15	10	15	420	90	17.9	2.4%
CFW900C56P0T2	56	20	15	20	15	20	538	114	22.3	2.5%
CFW900C70P0T2	70	25	18.5	25	20	25	627	128	27.9	2.3%
CFW900C80P0T2	80	30	22	30	25	30	710	142	31.9	2.3%
CFW900D0110T2	110	40	30	40	30	40	956	172	43.8	2.2%
CFW900D0135T2	135	50	37	50	40	50	1192	208	53.8	2.3%
CFW900D0150T2	150	60	45	60	50	50	1363	233	59.8	2.3%
CFW900E0172T2	172	60	55	75	60	60	1629	300	68.5	2.4%
CFW900E0195T2	195	75	55	75	60	75	1897	337	77.7	2.5%
CFW900E0250T2	250	100	75	100	75	100	2375	402	99.6	2.4%

⁽¹⁾ Inverter efficiency rating: see item 8.1.1. Inverter losses at the other seven operating points specified by IEC61800-9-2 standard: see specific document on Ecodesign Directive. To determine losses for different motors, use the WEG Ecodrive app.

⁽²⁾ Rated power values defined based on the rated current of WEG motors at the indicated voltages. Item 8.1.4 indicates the maximum inverter ambient temperature considered for choosing the motor.

Table 8.6: Current, power and loss data for B2 and T2 lines and “HD” overload class

Inverter model	HD overload class: 150% for 60 seconds with a 5-minute interval 200% for 3 seconds with a 5-minute interval						Dissipated power for sizing the panel		Inverter loss data as per IEC61800-9-2 ⁽¹⁾		
	Rated output current	Typical motor ⁽²⁾							Inverter complete	Front part	Rated apparent power
		220V/60Hz	230V/50Hz	230V/60Hz	NEC Table 208V	NEC Table 230V	230V				
		Io,nom (HD) [Arms]	P _{nom} [CV]	P _{nom} [kW]	P _{nom} [hp]	P _{nom} [hp]	P _{nom} [hp]	PL(inv) [W]			
CFW900A04P6B2	4.6	1.5	1.1	1.5	1	1	81	34	1.8	4.4%	
CFW900A06P0B2	6	2	1.5	2	1	1.5	96	39	2.4	4.1%	
CFW900A07P5B2	7.5	2	1.5	2	2	2	109	41	3	3.7%	
CFW900A10P0B2	10	3	2.2	3	2	3	127	46	4	3.2%	
CFW900A04P6T2	4.6	1.5	1.1	1.5	1	1	70	30	1.8	3.9%	
CFW900A06P0T2	5	1.5	1.5	2	1	1	73	31	2	3.7%	
CFW900A07P5T2	6.8	2	1.5	2	1.5	2	85	33	2.7	3.2%	
CFW900A10P6T2	9.6	3	2.2	3	2	3	102	35	3.8	2.7%	
CFW900A13P0T2	11	3	3	3	3	3	111	37	4.4	2.6%	
CFW900A19P0T2	16	5	4	5	3	5	143	42	6.3	2.3%	
CFW900B26P0T2	22	7.5	5.5	7.5	5	7.5	212	59	8.7	2.5%	
CFW900B34P0T2	28	10	7.5	10	7.5	10	260	67	11.1	2.4%	
CFW900B45P0T2	35	12.5	9.2	10	10	10	320	76	13.9	2.3%	
CFW900C56P0T2	47	15	11	15	15	15	447	103	18.7	2.4%	
CFW900C70P0T2	59	20	15	25	15	20	523	115	23.5	2.3%	
CFW900C80P0T2	70	25	18.5	30	20	25	614	129	27.9	2.2%	
CFW900D0110T2	92	30	22	30	30	30	784	148	36.6	2.2%	
CFW900D0135T2	110	40	30	40	30	40	942	172	43.8	2.2%	
CFW900D0150T2	124	50	37	50	40	40	1081	192	49.4	2.2%	
CFW900E0172T2	150	60	45	60	50	50	1391	267	59.7	2.4%	
CFW900E0195T2	160	60	45	60	50	60	1497	281	63.7	2.4%	
CFW900E0250T2	211	75	55	75	75	75	1934	342	84	2.4%	

⁽¹⁾ The dissipated power for sizing the panel must be considered the same specified for the ND overload class according to [Table 8.5](#).

⁽²⁾ Rated power values defined based on the rated current of WEG motors at the indicated voltages. [Item 8.1.4](#) indicates the maximum inverter ambient temperature considered for choosing the motor.

Table 8.7: Current, power and loss data for T4 line and "ND" overload class

Inverter model	ND overload class: 110% for 60 seconds with a 5-minute interval 150% for 3 seconds with a 5-minute interval						Dissipated power for sizing the panel		Inverter loss data as per IEC61800-9-2 ⁽¹⁾	
	Rated output current	Typical motor ⁽²⁾							Inverter complete	Front part
		380V/60Hz	400V/50Hz	440V/60Hz	460V/60Hz	NEC Table 460V				
		Io,nom (ND) [Arms]	P _n nom [CV]	P _n nom [kW]	P _n nom [hp]	P _n nom [hp]	P _n nom [hp]	PL(inv) [W]		
CFW900A02P8T4	2.8	1.5	1.1	1.5	2	1	66	30	1.9	3.5%
CFW900A03P6T4	3.6	2	1.5	2	2	2	72	31	2.5	2.9%
CFW900A04P8T4	4.8	3	2.2	3	3	3	90	33	3.3	2.7%
CFW900A06P5T4	6.5	3	3	4	5	4	110	36	4.5	2.5%
CFW900A09P6T4	9.6	6	4	6	7.5	5	145	42	6.7	2.2%
CFW900A14P0T4	14	7.5	7.5	10	10	10	201	48	9.7	2.1%
CFW900A17P0T4	17	10	7.5	12.5	10	10	236	54	11.8	2.0%
CFW900B26P0T4	26	15	11	20	20	15	366	82	18.0	2.1%
CFW900B33P0T4	33	20	15	25	25	20	409	87	22.9	1.8%
CFW900B39P0T4	39	25	18.5	30	30	25	473	97	27.0	1.8%
CFW900C50P0T4	50	30	22	40	40	30	671	133	34.6	2.0%
CFW900C62P0T4	62	40	30	50	50	40	727	143	43.0	1.7%
CFW900C74P0T4	74	50	37	60	60	50	844	161	51.3	1.7%
CFW900D96P0T4	96	60	45	75	75	75	1132	195	66.5	1.8%
CFW900D0124T4	124	75	55	100	100	100	1408	233	85.9	1.7%
CFW900D0146T4	146	100	75	125	125	100	1656	271	101.2	1.7%
CFW900E0172T4	172	125	90	125	150	125	1789	333	119.2	1.6%
CFW900E0203T4	203	150	110	150	175	150	2170	384	140.6	1.6%
CFW900E0242T4	242	175	132	200	200	200	2504	428	167.7	1.5%

⁽¹⁾ Inverter efficiency rating: see [item 8.1.1](#). Inverter losses at the other seven operating points specified by IEC61800-9-2 standard: see specific document on Ecodesign Directive. To determine losses for different motors, use the WEG Ecodrive app.

⁽²⁾ Rated power values defined based on the rated current of WEG motors at the indicated voltages. [Item 8.1.4](#) indicates the maximum inverter ambient temperature considered for choosing the motor.

Table 8.8: Current, power and loss data for T4 line and "HD" overload class

Inverter model	HD overload class: 150% for 60 seconds with a 5-minute interval 200% for 3 seconds with a 5-minute interval						Dissipated power for sizing the panel		Inverter loss data as per IEC61800-9-2 ⁽¹⁾	
	Rated output current	Typical motor ⁽²⁾							Inverter complete	Front part
		380V/60Hz	400V/50Hz	440V/60Hz	460V/60Hz	NEC Table 460V	400V	pL(90,100)		
		Io,nom (HD) [Arms]	P,nom [CV]	P,nom [kW]	P,nom [hp]	P,nom [hp]	P,nom [hp]	PL(inv) [W]		
CFW900A02P8T4	2.4	1	1.1	1.5	1.5	1	60	29	1.6	3.6%
CFW900A03P6T4	2.8	1.5	1.1	1.5	2	1	61	30	1.9	3.2%
CFW900A04P8T4	3.9	2	1.5	2	3	2	76	31	2.7	2.8%
CFW900A06P5T4	5.3	3	2.2	3	3	3	92	34	3.7	2.5%
CFW900A09P6T4	8	4	3	5	5	5	122	39	5.5	2.2%
CFW900A14P0T4	12	6.0	5.5	7.5	7.5	7.5	172	45	8.3	2.1%
CFW900A17P0T4	17	7.5	7.5	12.5	10	10	236	54	11.8	2.0%
CFW900B26P0T4	21	12.5	11	12.5	15	15	307	74	15.2	2.1%
CFW900B33P0T4	28	12.5	11	20	20	20	342	79	19.4	1.8%
CFW900B39P0T4	33	20	15	20	25	20	397	87	22.8	1.8%
CFW900C50P0T4	40	20	18.5	20	30	30	540	118	28.4	2.0%
CFW900C62P0T4	50	20	22	20	40	30	580	124	34.6	1.7%
CFW900C74P0T4	62	40	30	40	50	40	708	146	42.9	1.7%
CFW900D96P0T4	75	50	37	60	60	50	862	158	51.9	1.7%
CFW900D0124T4	103	60	55	75	75	75	1152	198	71.4	1.7%
CFW900D0146T4	124	75	55	75	100	100	1379	232	85.9	1.7%
CFW900E0172T4	146	100	75	125	125	100	1500	297	101.2	1.5%
CFW900E0203T4	161	100	90	125	125	125	1609	311	108.1	1.5%
CFW900E0242T4	190	125	90	150	150	150	1908	350	131.6	1.5%

⁽¹⁾ The dissipated power for sizing the panel must be considered the same specified for the ND overload class according to [Table 8.7](#).

⁽²⁾ Rated power values defined based on the rated current of WEG motors at the indicated voltages. [Item 8.1.4](#) indicates the maximum inverter ambient temperature considered for choosing the motor.

The permissible overload class curve for the inverters of the CFW900 line are shown in [Figure 8.1](#).

WARNING!
Apply one overload every five minutes at most.

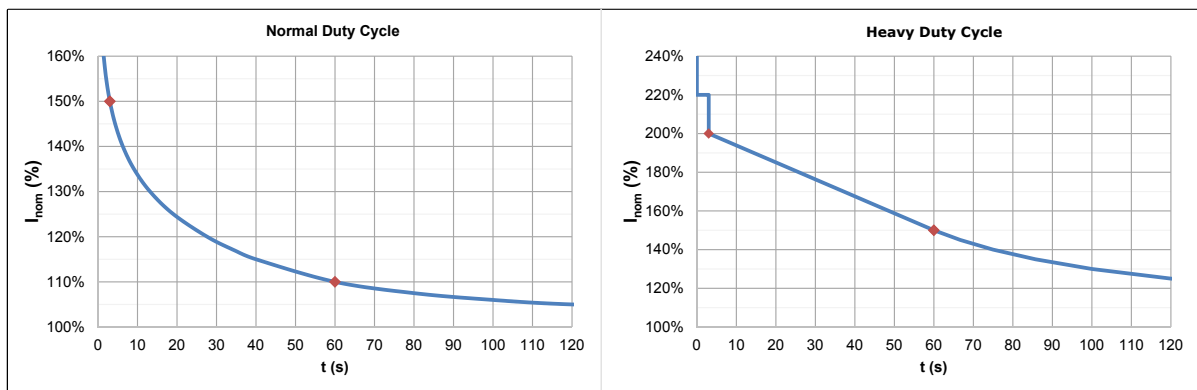
Figure 8.1: Permissible overload

8.2 DEFINITIONS OF DERATING FACTORS

8.2.1 Introduction

This item of the manual deals with the derating that should be considered when sizing the inverter. In cases where more than one condition require the output current derating, the factors must be multiplied according to the equation below:

$$FD = FD_{ta} * FD_{fsw} * FD_{al} * FD_{others}$$

Where,

- FD is the total derating factor;
- FD_{ta} is the derating factor due to the inverter ambient temperature;
- FD_{fsw} is the derating factor due to the user-set switching frequency;
- FD_{al} is the derating factor due to installation altitude;
- FD_{others} is the derating factor due to other factors.

8.2.2 Derating factor according to the Ambient Temperature (FD_{ta})

The rated operating temperature of CFW900 is -10 °C to 50 °C (14 °F to 122 °F) for frames A ... D, and -10 °C to 45 °C (14 °F to 113 °F) in frame E, without the need to reduce the output current ($T_{a,nom} = 50$ °C (122 °F) for frame A ... D, and $T_{a,nom} = 45$ °C (113 °F) for frame E). This is valid considering the inverter factory settings (rated switching frequency and thermal management function enabled) ⁽¹⁾. The thermal management function protects the inverter during overloads through a smart control that limits the maximum temperature of the IGBTs. If it is not possible to operate with a switching frequency below the rated one during overloads, disable the thermal management function and consider 40 °C (104 °F) the maximum inverter temperature. The maximum inverter temperature is also 40 °C (104 °F) when you want to use a switching frequency above the rated one.

⁽¹⁾ This is also valid when the switching frequency is set at maximum of 2 kHz for frames A ... D and 1.5 kHz for frame E. In this case the maximum ambient temperature of the inverter is independent of its thermal management function.

It is possible to operate CFW900 with an ambient temperature above the rated one by applying current derating, as shown in [Figure 8.2](#). The maximum operating ambient temperature is specified in [item 8.1.4](#) of this manual.

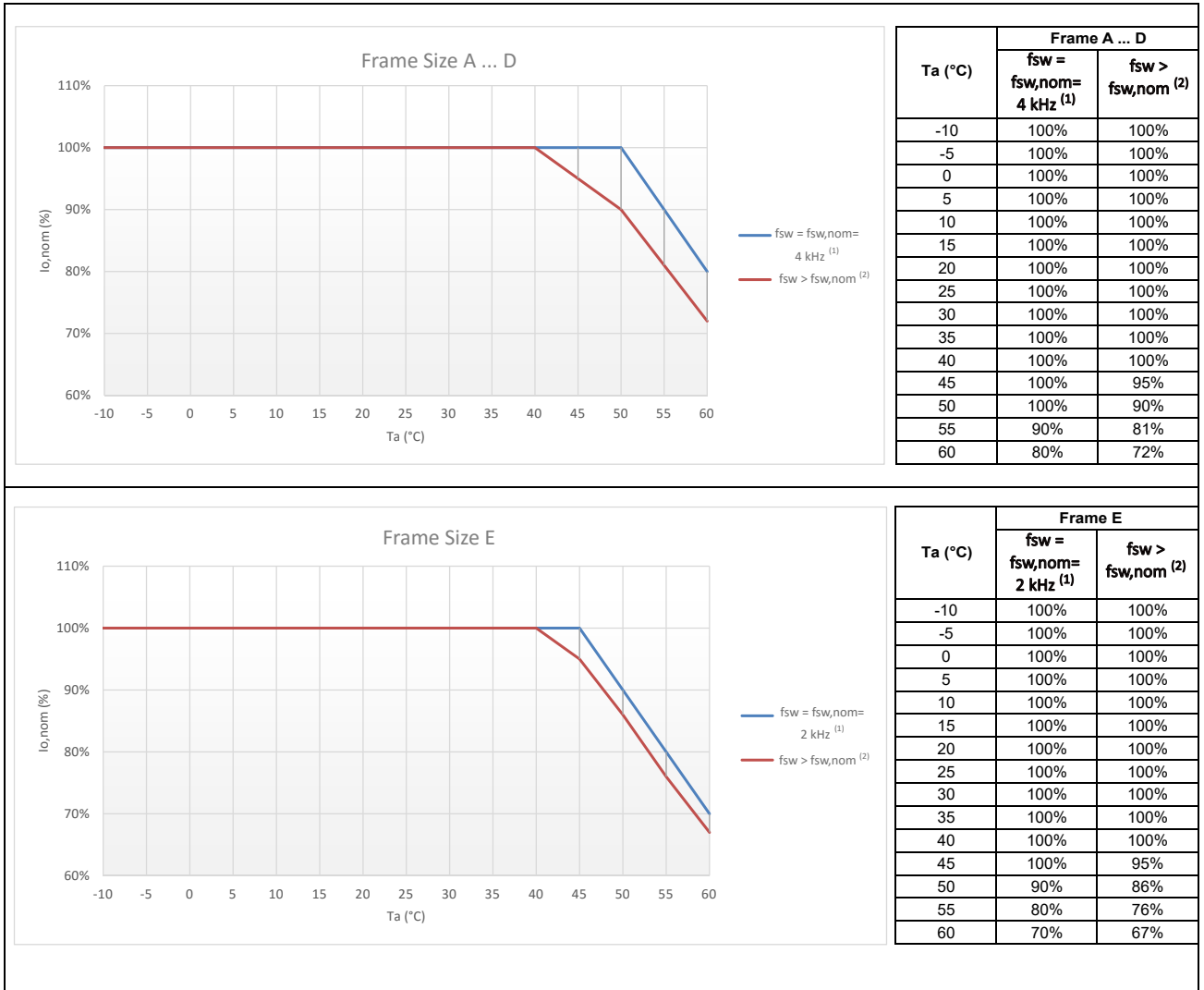

- ⁽¹⁾ With the inverter thermal management function enabled (if disabled see note (2) below) or $f_{sw} \leq 2$ kHz to frame size A...D and $f_{sw} \leq 1.5$ kHz to frame size E (in this case regardless of the inverter thermal management function).
- ⁽²⁾ This curve must also be used when $f_{sw} = f_{sw,nom}$ and the inverter thermal management function is disabled.

Figure 8.2: Current derating according to the ambient temperature (note that the current derating also depends on the switching frequency (f_{sw}) set in parameter C1.3.1 (User Switching Frequency))

8.2.3 Derating factor according to the Switching Frequency (FD_{fsw})

The rated and maximum switching frequency of CFW900 are defined in [item 8.1.2](#). It is possible to operate with a frequency above the rated one, limited to the maximum frequency; however, in these cases it is necessary to derating the rated current, as shown in [Figure 8.3](#).

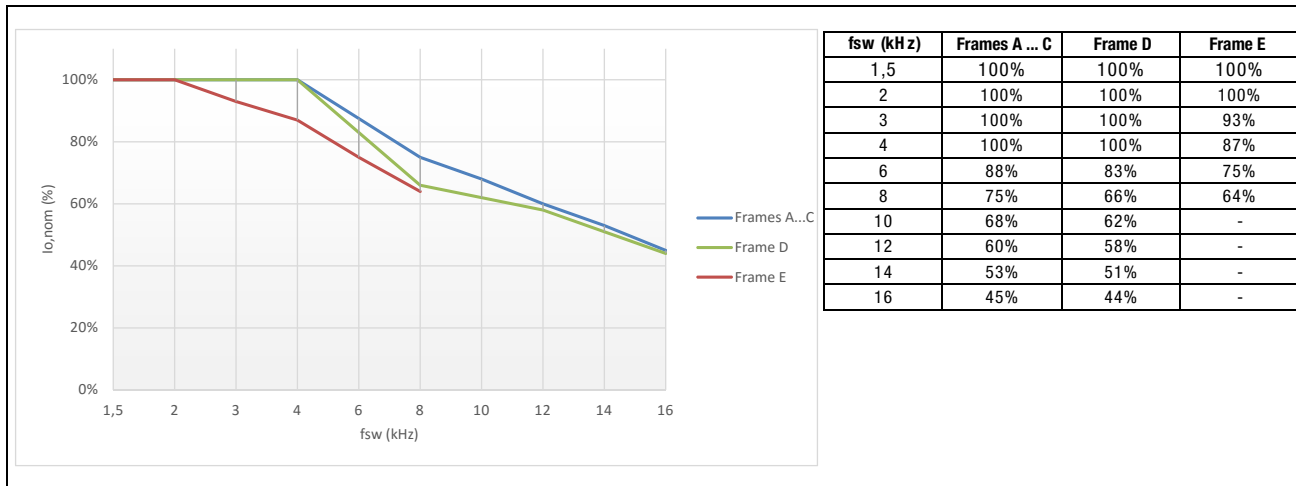

Figure 8.3: Current derating as a function of the switching frequency in the inverter factory settings condition

In some models of the CFW900 line, it is not possible to follow the derating curve shown in Figure 8.3. In these cases, the values of Table 8.9.

If it is not possible to operate with a switching frequency lower than the rated one during overloads, the thermal management function must be disabled, and in these cases, only for the indicated models, the derating values will be the ones shown in Table 8.9.

Table 8.9: Current derating as a function of the switching frequency

fsw,nom [kHz]	Thermal management	CFW900B45P0T2	CFW900B26P0T4	CFW900C80P0T2	CFW900C50P0T4	CFW900D0150T2	CFW900D0146T4	CFW900E0203T4	CFW900E0242T4
1	ID ⁽¹⁾	NAL ⁽²⁾	NAL ⁽²⁾	NAL ⁽²⁾	100%				
1,5	ID ⁽¹⁾	100%	100%	100%	100%				
2	Enabled	100%	100%	100%	100%				
	Disabled	100%	100%	100%	94%				
3	Enabled	100%	100%	100%	87%				
	Disabled	98%	97%	98%	87%				
4	Enabled	100%	100%	100%	80%				
	Disabled	96%	94%	97%	80%				
6	ID ⁽¹⁾	84%	84%	83%	65%				
8	ID ⁽¹⁾	72%	75%	70%	50%				
10	ID ⁽¹⁾	65%	67%	63%	NAL ⁽²⁾				
12	ID ⁽¹⁾	58%	60%	57%	NAL ⁽²⁾				
14	ID ⁽¹⁾	50%	53%	50%	NAL ⁽²⁾				
16	ID ⁽¹⁾	43%	46%	43%	NAL ⁽²⁾				

(1) Indifferent.
(2) Not allowed.

8.2.4 Derating factor according to the Altitude of the Installation Site

The maximum operating altitude is 1000 meters under rated conditions.

From 1000 m to 4000 m: derate the current by 1% for each increment of 100 m (this is the FDal factor).

From 2000 m to 4000 m: in addition to applying the current derating factor as mentioned above, it is necessary to reduce the maximum rms supply voltage of the inverter (240 V for 220...240 V models and 480 V for 380...480 V models) by 1.1% for each 100 m above 2000 m.

Figure 8.4 graphically illustrates the output current and supply voltage derating specifications according to the altitude.

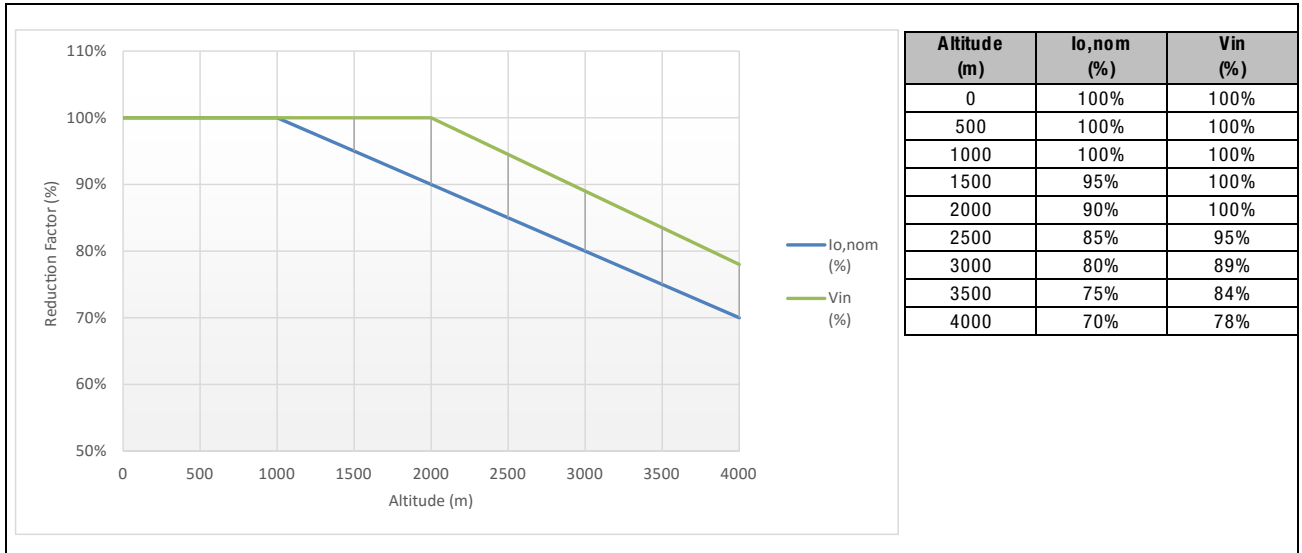

Figure 8.4: Current derating as a function of the installation altitude

8.2.5 Other Derating Factors

There are factors related to the inverter application that require rated current derating. In these cases, WEG must be consulted.

- Prolonged inverter operation at low output frequencies (<5 Hz).
- Repetitive cycle applications with high motor current at low speeds (e.g., accelerations and decelerations).

The current derating factor must be set in the C1.6.4 parameter (Manual Reduction Inom).

8.3 INVERTER CONTROL DATA

8.3.1 General Control Specifications

Table 8.10: Control circuit data

Motor control	Method	Voltage source.
	Type of Control	<ul style="list-style-type: none"> ■ V/f (Scalar). ■ VVV: voltage vector control. ■ Vector control with encoder. ■ Sensorless vector control (without encoder).
	Supported motors	<ul style="list-style-type: none"> ■ Induction engine. ■ Permanent magnet motor.
	Modulation	<ul style="list-style-type: none"> ■ SVPWM space vector PWM standard. ■ PWM optimized for long output cables.
	Measurements and indications	<ul style="list-style-type: none"> ■ Current measurement accuracy: 5% of the rated current. ■ Speed resolution: 1rpm. ■ Built-in real-time clock.
	Output frequency	Maximum output frequency limited to 500 Hz for frames A ... D and 250 Hz for frame E.
Safety	Inverter Protection	<ul style="list-style-type: none"> ■ Output overcurrent/short-circuit. ■ Under/overvoltage. ■ Phase loss. ■ Overtemperature. ■ Overload on the motor, braking resistor and IGBTs. ■ External Fault/Alarm. ■ Output phase-ground short-circuit.
	Functions	Built-in STO and SS1-t functions. See the safety manual.
Integral Keypad (HMI)		<ul style="list-style-type: none"> ■ 12 operator keys: Run/Stop, Direction of Rotation, Jog, Local/ Remote and browsing buttons: Left, Right, Up, Down, Enter, Back and Help. ■ Graphical LCD display. ■ View/editing of all parameters. ■ Option of external mounting, using: <ul style="list-style-type: none"> unshielded pin-to-pin DB9 cable up to 20 m; shielded pin-to-pin DB9 cable up to 100 m. ■ Communication with smartphone using Bluetooth (for models equipped with CFW900-HMI-BLT). ■ USB communication with PC using WEG WPS. ■ Allows powering the HMI and the control board through the USB port for inverter parameterization without powering up the network or DC link.
MicroSD card slot		<ul style="list-style-type: none"> ■ One microSD card slot. ■ Card requirements: <ul style="list-style-type: none"> Maximum size of 32 GB; Industrial Temperature (-40 °C (-40 °F) to 85 °C (185 °F)); FAT32 file system. ■ Miscellaneous functions: see programming manual. ■ MicroSD card not included.

8.3.2 Input and Output Specifications
Table 8.11: Characteristics of analog and digital inputs and outputs (XC1)

Digital input DI1 to DI4	<ul style="list-style-type: none"> ■ 4 isolated digital inputs. ■ Low level: Vdc -3 V to 5 V, I<1,5 mA. ■ High level: Vdc > 11 V, I>2 mA. ■ Current 8mA@24V (Typical). ■ Maximum voltage: 30 Vdc. ■ Maximum current: 11mA@30Vdc.
Digital input DI5 and DI6	<ul style="list-style-type: none"> ■ 2 isolated digital inputs. ■ Low level: Vdc -3 V to 5 V, I<0,5 mA. ■ High level: Vdc > 15 V, I>2 mA. ■ Current 10mA@24V (Typical). ■ Maximum voltage: 30 Vdc. ■ Maximum current: 13mA@30Vdc. ■ Maximum frequency: 32 kHz. ■ Input for encoder signals (maximum cable length of 3 m).
Analog inputs	<ul style="list-style-type: none"> ■ 2 differential analog inputs. ■ Isolated from power circuits. ■ Levels: -10/0 at 10 V (11 bits + signal), 0/4 at 20 mA (10 bits). ■ Maximum voltage: 30 V. ■ Maximum current: 25 mA. ■ Impedance: 400 kΩ (voltage mode), 250 Ω (current mode). ■ Maximum common mode voltage: 10 V.
Digital outputs	<ul style="list-style-type: none"> ■ 2 transistor digital outputs (NPN). ■ Isolated from power circuits. ■ Maximum current: 40 mA. ■ Protected against short circuit to the GND. ■ Maximum voltage: 24 Vdc. ■ With freewheeling diode for 24 Vdc power supply. ■ Maximum frequency: 32 kHz.
Analog outputs	<ul style="list-style-type: none"> ■ 2 analog outputs. ■ Isolated from power circuits. ■ Levels: 0 at 10 V (12 bits), 0/4 at 20 mA (12 bits). ■ Load: $R_L \geq 1k\Omega$ (voltage mode), $R_L \leq 600\Omega$ (current mode).

Table 8.12: Characteristics of the inputs and outputs of the internal safety module (XC2)

STO1 and STO2 Digital Input	<ul style="list-style-type: none"> ■ Redundant inputs for OSSD signals or dry contact signals.
SP1 and SP2 test digital output	<ul style="list-style-type: none"> ■ Outputs to power dry contact.
24VS power supply input	<ul style="list-style-type: none"> ■ Input for 24 V power supply $\pm 15\%$ to the internal safety module.

*For more details, see the safety manual.

Table 8.13: Characteristics of the CFW900-REL-01 (XC30)

Relay output	<ul style="list-style-type: none"> ■ 2 relay outputs with NO contact. ■ 1 relay output with NO/NC contact. ■ Maximum voltage: 30 Vdc, 250 Vac, OVC III. ■ Maximum current: 2 A. ■ Minimum current: 10 mA@5 Vdc. ■ 400 V TVS between contacts.
--------------	---

8.3.3 Specifications of the Communication Networks
Table 8.14: Communication network data

RS-485	<ul style="list-style-type: none"> ■ Isolated RS-485 Interface. ■ Modbus-RTU Protocol. ■ Can be used to program the inverter via WEG WPS software application.
Dual port Ethernet network	<ul style="list-style-type: none"> ■ Two RJ-45 Ethernet connectors. ■ 10/100 Mbps data rate with built-in dual port switch. ■ Protocol: Modbus TCP. ■ Can be used to program the inverter via WEG WPS software application.

8.3.4 Standards and Certifications
Table 8.15: Specification of standards and certifications met

Safety standards	UL61800-5-1 - "Adjustable Speed Electrical Power Drive Systems - Part 5-1: Safety Requirements - Electrical, Thermal and Energy" Nota: "Suitable for Installation in a compartment handling conditioned air"
	EN 61800-5-1 - "Safety requirements electrical, thermal and energy"
	EN 50178 - "Electronic equipment for use in power installations"
Specification standards	EN 60146 (IEC 146) - "Semiconductor converters"
	EN 61800-2 - "Adjustable speed electrical power drive systems - Part 2: general requirements - Rating specifications for low voltage adjustable frequency AC power drive systems"
Electromagnetic compatibility standards (EMC)	EN 61800-3 - "Adjustable speed electrical power drive systems - Part 3: EMC product standard including specific test methods"
	EN 55011 - "Limits and methods of measurement of radio disturbance characteristics of industrial, scientific and medical (ISM) radio-frequency equipment"
	CISPR 11 - Industrial, scientific and medical (ISM) radio-frequency equipment
	EN 61000-4-2 - "Electromagnetic compatibility (EMC) - Part 4: testing and measurement techniques - Sec. 2: electrostatic discharge immunity test"
	EN 61000-4-3 - "Electromagnetic compatibility (EMC) - Part 4: testing and measurement techniques - Sec. 3: radiated, radio-frequency, electromagnetic field immunity test"
	EN 61000-4-4 - "Electromagnetic compatibility (EMC) - Part 4: testing and measurement techniques - Sec. 4: electrical fast transient/burst immunity test"
	EN 61000-4-5 - "Electromagnetic compatibility (EMC) - Part 4: testing and measurement techniques - Sec. 5: surge immunity test".
	EN 61000-4-6 - "Electromagnetic compatibility (EMC) - Part 4: testing and measurement techniques - Sec. 6: immunity to conducted disturbances, induced by radio-frequency fields"
	EN 61000-4-11 - "Testing and measurement techniques - Voltage dips, short interruptions and voltage variations immunity tests"
Frame standards	EN 60529 - "Degrees of protection provided by enclosures (IP code)"
	UL 50 - "Enclosures for electrical equipment"
Ecodesign standards	IEC 61800-9-2 Parts 1 & 2 - "Adjustable speed electrical power drive systems - Ecodesign for power drive systems, motor starters, power electronics and their driven applications"
Functional safety standards	EN 61800-5-2 - Adjustable speed electrical power drive systems - Part 5-2: Safety requirements - Functional
	EN ISO 13849-1 - Safety of machinery - Safety-related parts of control systems - Part 1: General principles for design
	EN 62061 - Safety of machinery - Functional safety of safety-related control systems
	IEC 61508 Parts 1-7 - Functional safety of electrical/electronic/programmable electronic safety-related systems
	EN 60204-1 - Safety of machinery - Electrical equipment of machines - Part 1: General requirements
Directives	
Low-Voltage	2014/35/EU
EMC	2014/30/EU
RoHS	2011/65/EU 2015/863/EU
Ecodesign	2009/125/EC
Machinery	2006/42/EC
Certifications	
UL e cUL	E184430
CE	
Functional Safety	TÜV Rheinland Certificate

8.4 MECHANICAL DATA

8.4.1 Frame Size A

Model	Weight (mass) kg/lb
CFW900A	4,5 / 9,9

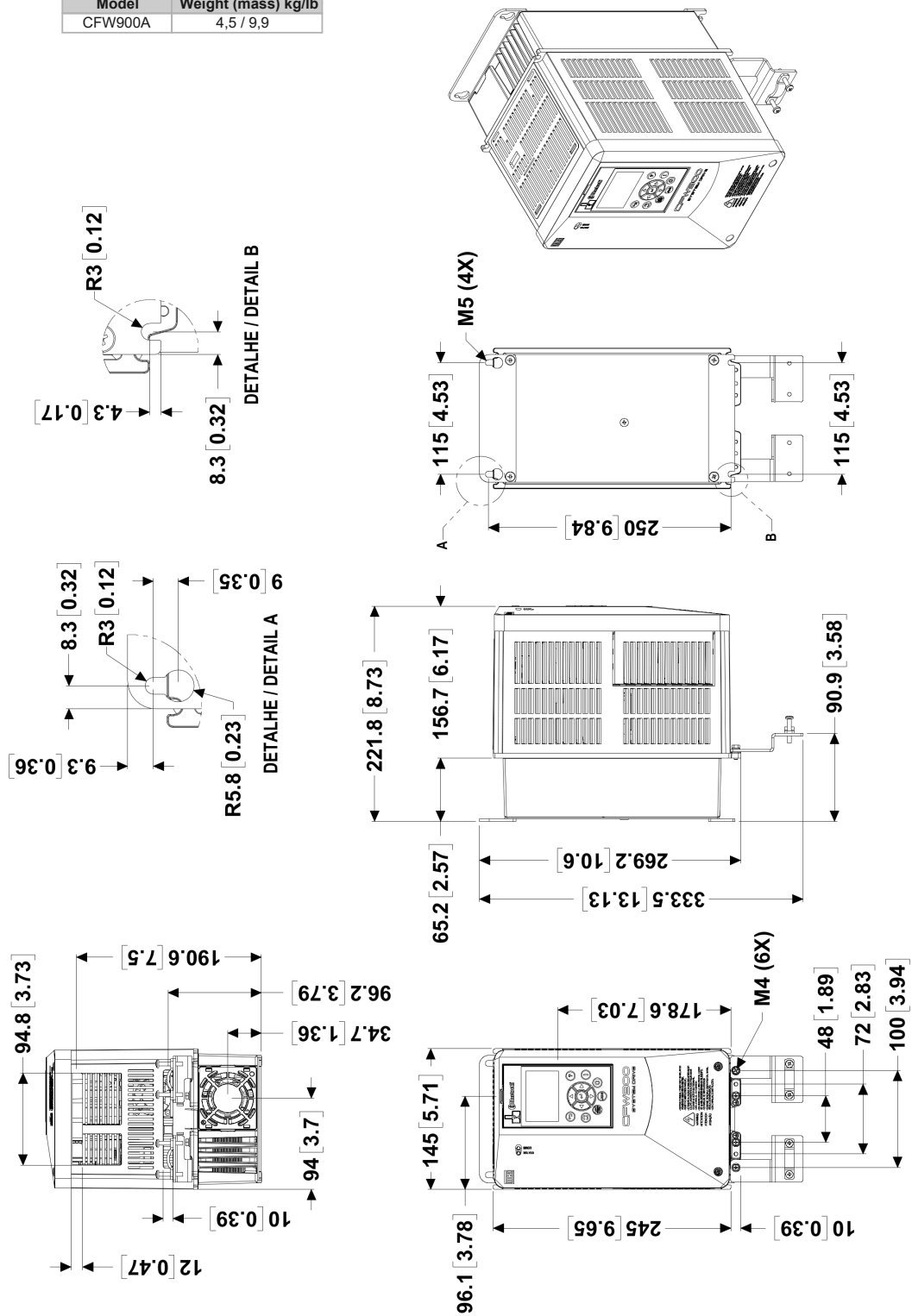

Figure 8.5: Dimensions for frame A - mm [in]

8.4.2 Frame Size B

Model	Weight (mass) kg/lb
CFW900B	10,0 / 22,0

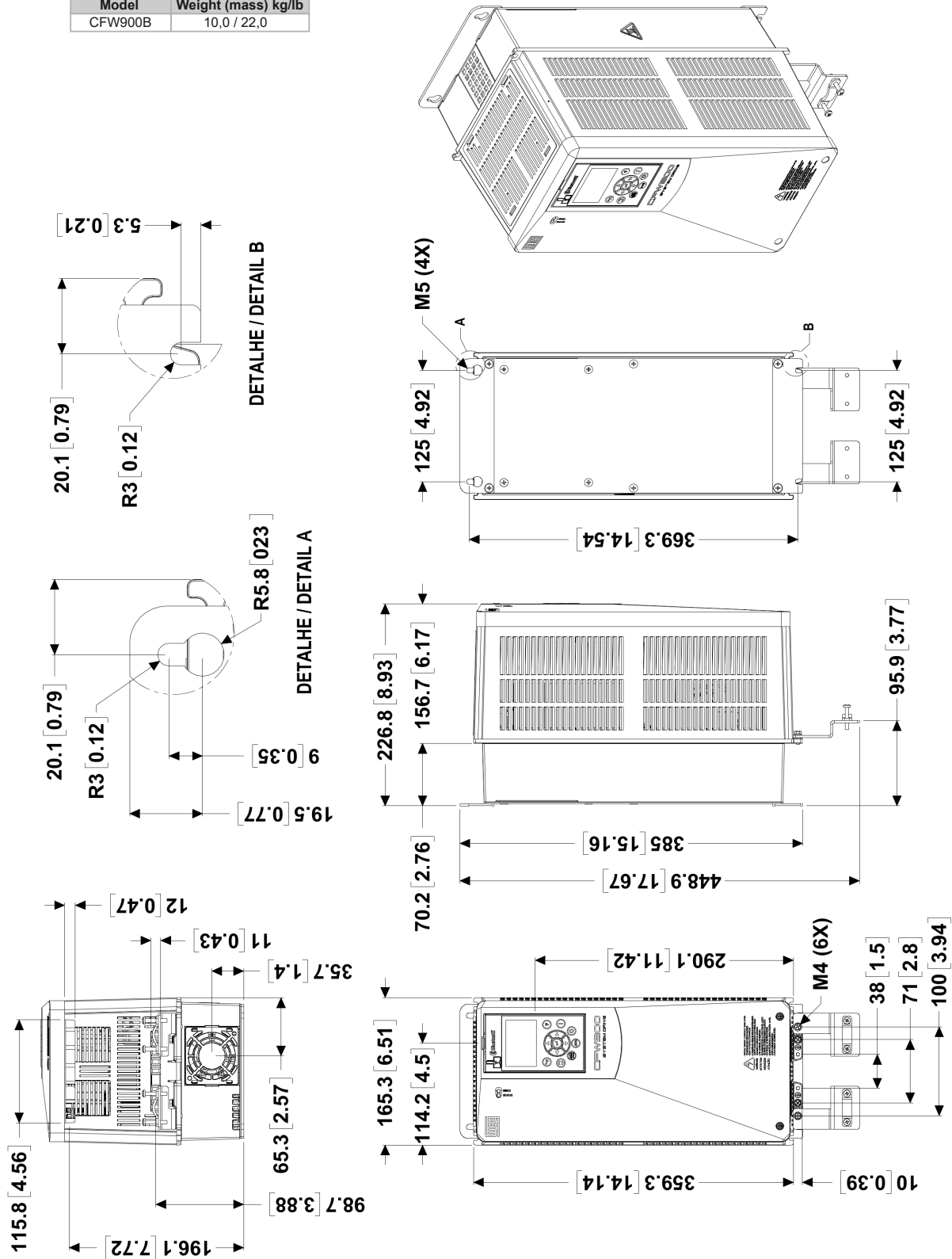

Figure 8.6: Dimensions for frame B - mm [in]

8.4.3 Frame Size C

Model	Weight (mass) kg/lb
CFW900C	20,5 / 45,2

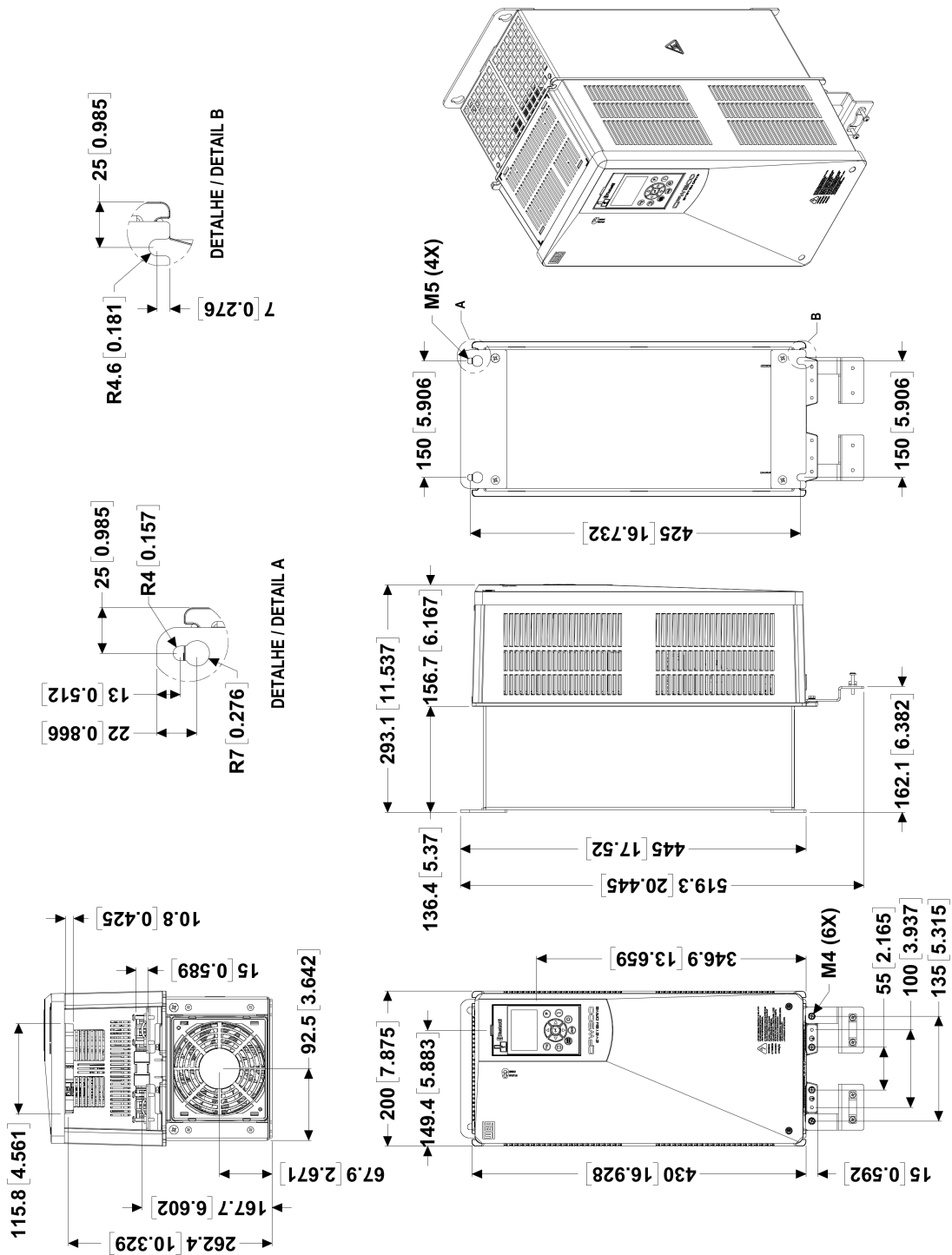

Figure 8.7: Dimensions for frame C - mm [in]

8.4.4 Frame Size D

English

Model	Weight (mass) kg/lb
CFW900D	33,5 / 73,8

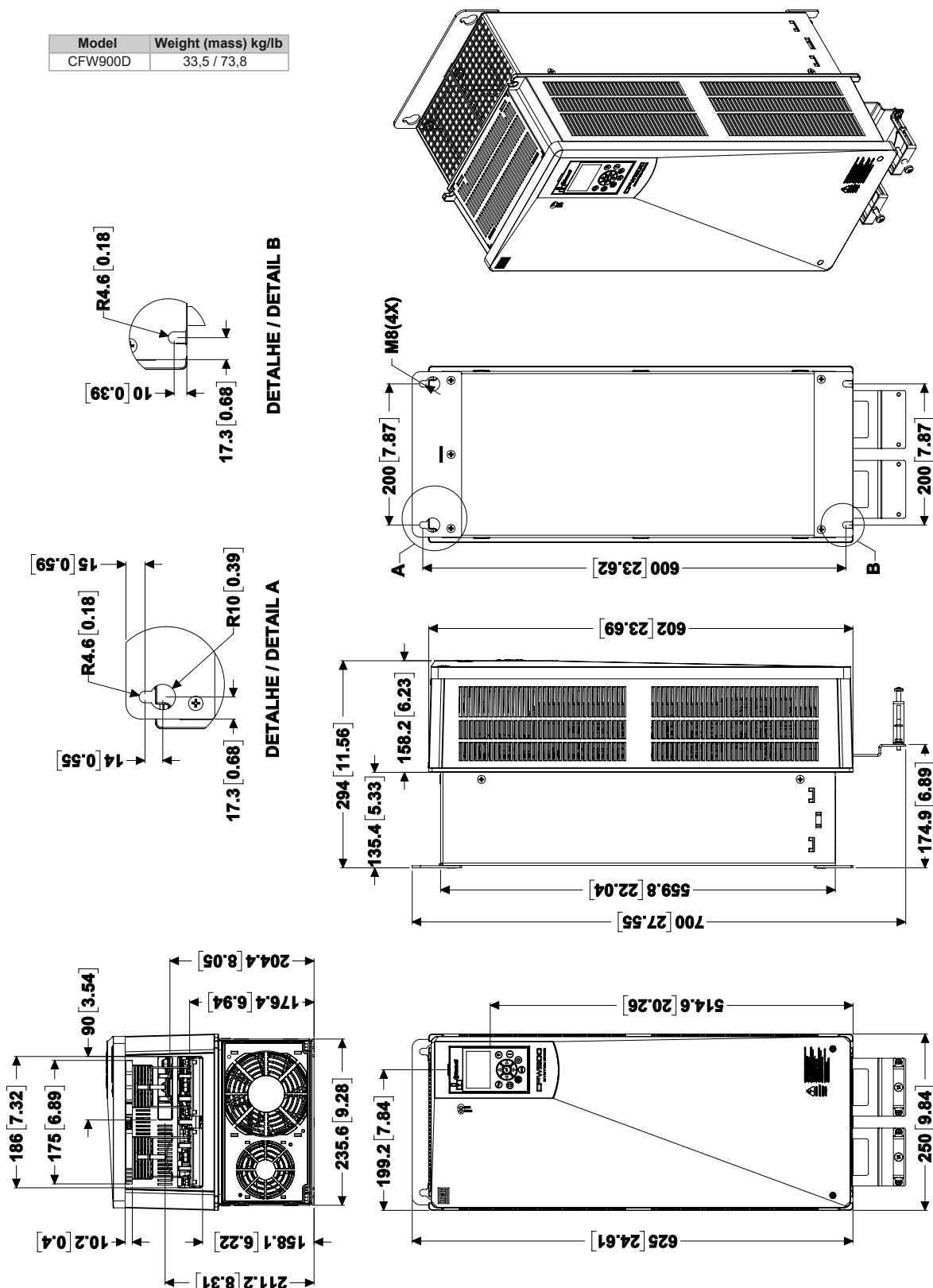

Figure 8.8: Dimensions for frame D - mm [in]

8.4.5 Frame Size E

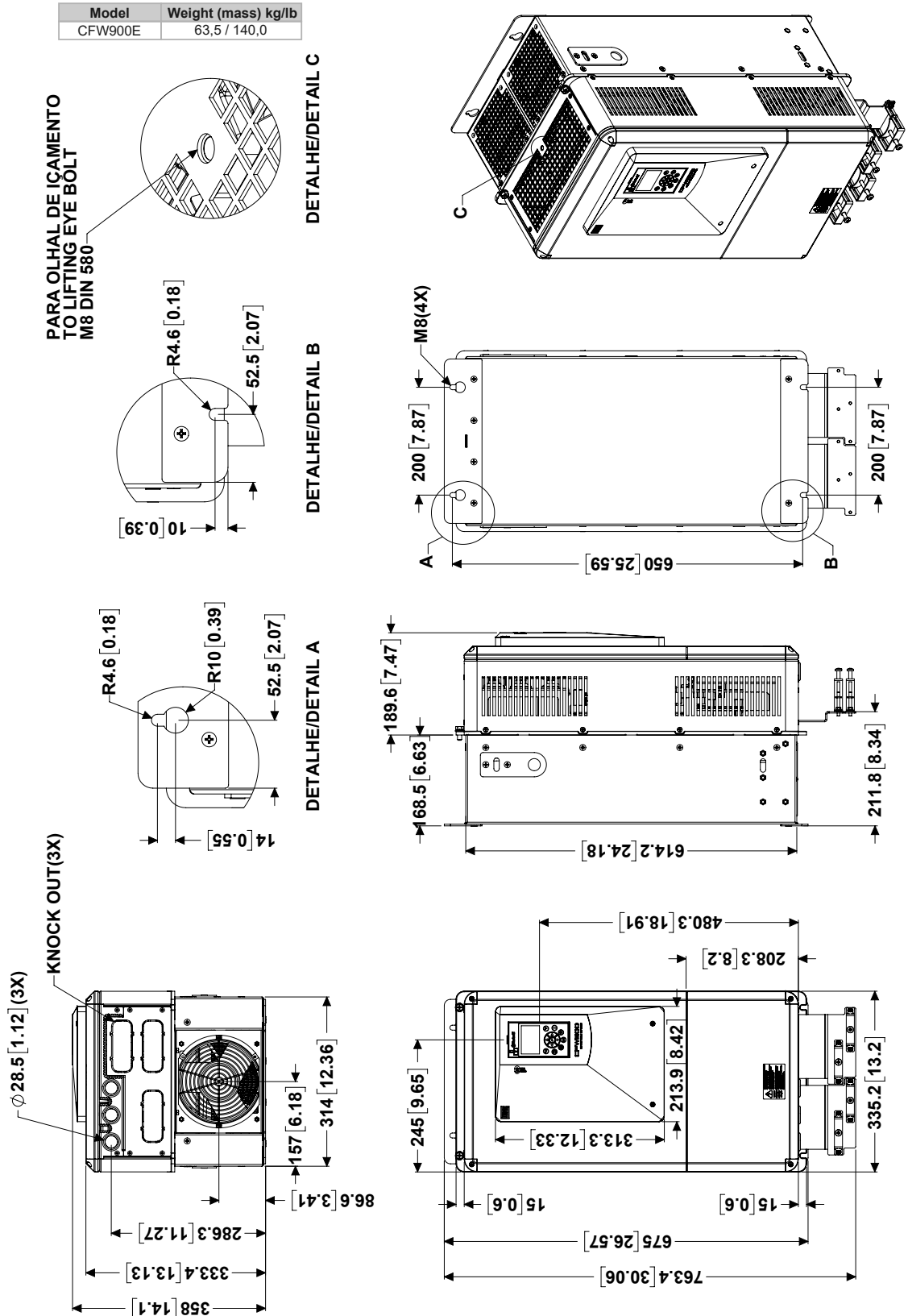
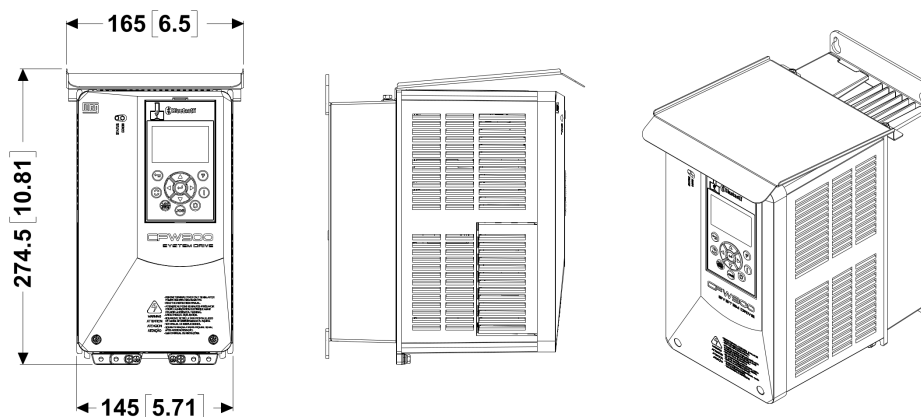

Figure 8.9: Dimensions for frame E - mm [in]

8.4.6 Frames A, B and C with IP21 kit

English



(a) Frame A with IP21 kit - "CFW900-IP21A" accessory

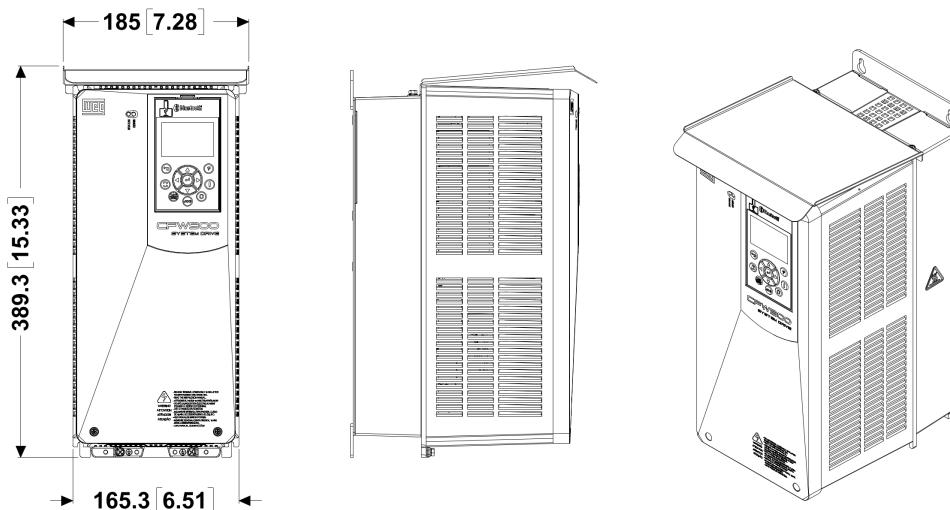

(b) Frame B with IP21 kit - "CFW900-IP21B" accessory

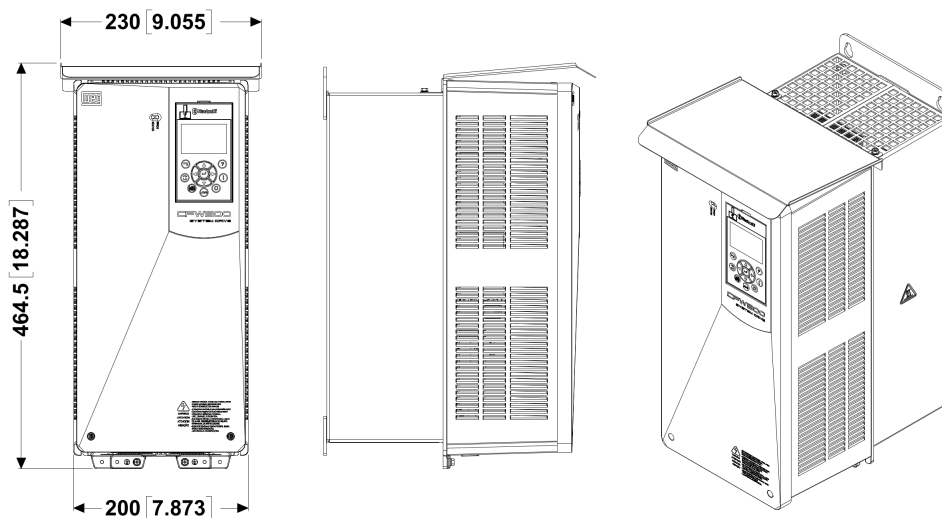

(c) Frame C with IP21 kit - "CFW900-IP21C" accessory

8.4.7 Frames D and E with IP21 kit

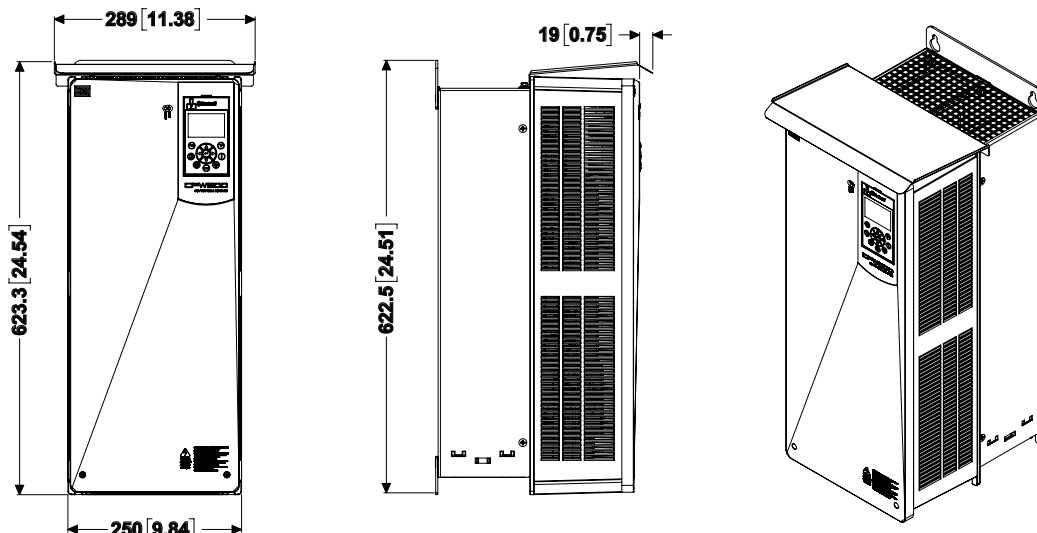

(a) Frame D with IP21 kit - "CFW900-IP21D" accessory

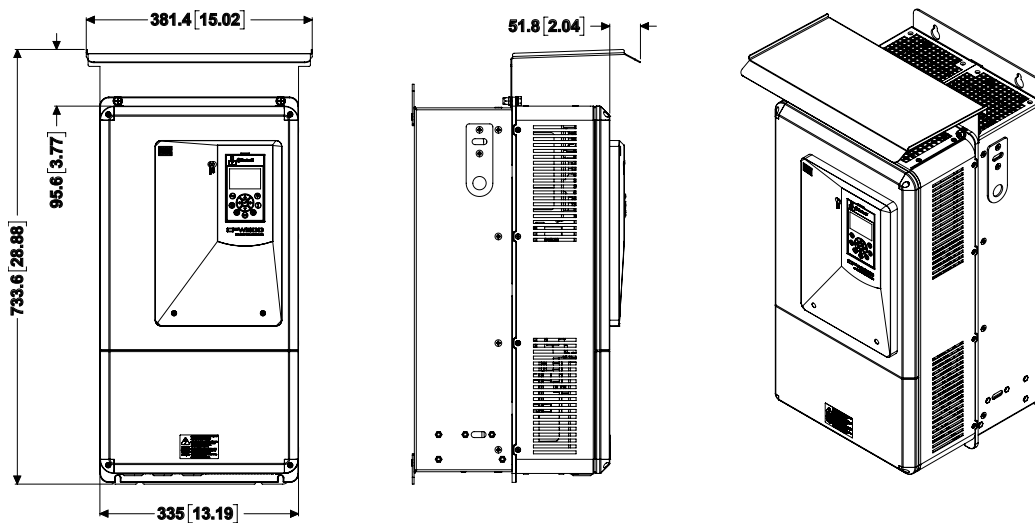

(b) Frame E with IP21 kit - "CFW900-IP21E" accessory

Figure 8.11: Inverter height with IP21 kit - mm [in]

8.4.8 Frames A, B and C with UL Type 1 kit

English

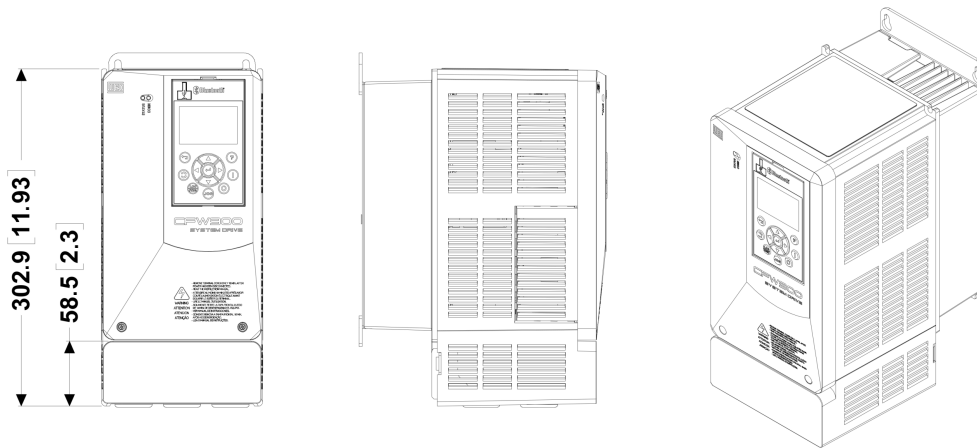

(a) Frame A with UL Type 1 kit - "CFW900-KN1A" accessory

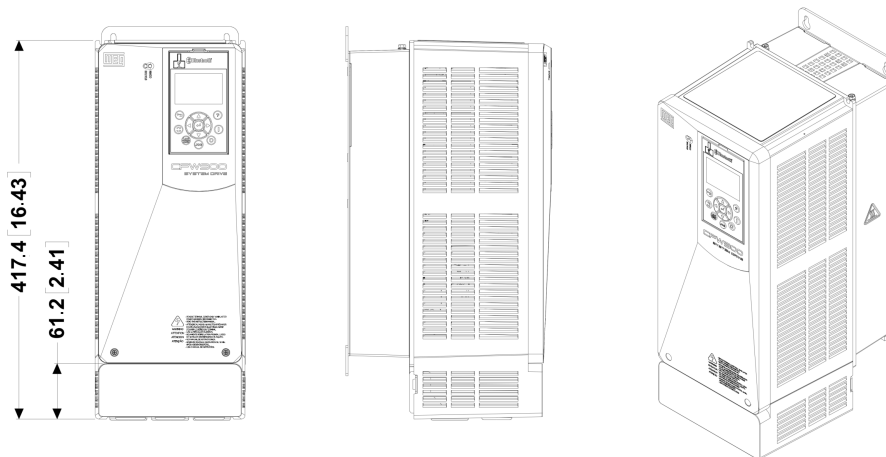

(b) Frame B with UL Type 1 kit - "CFW900-KN1B" accessory

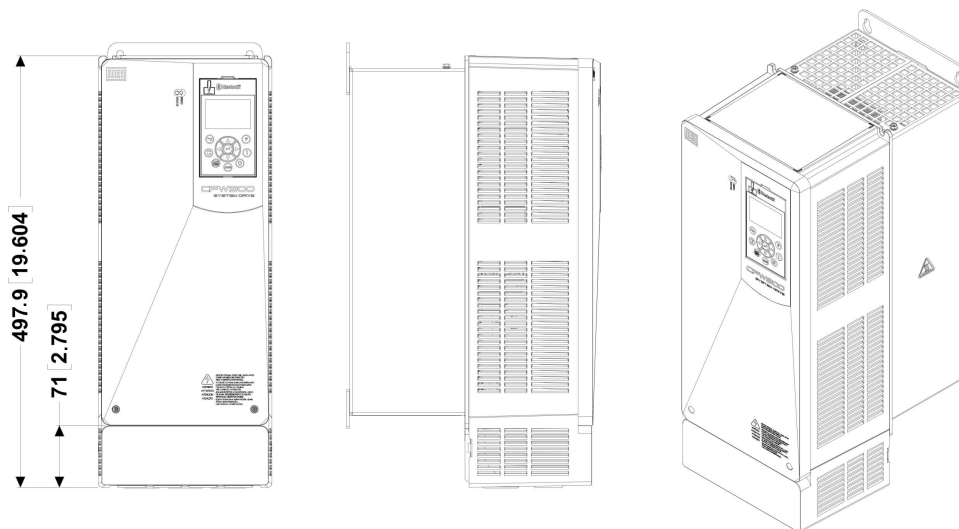

(c) Frame C with UL Type 1 kit - "CFW900-KN1C" accessory

Figure 8.12: Inverter height with UL Type 1 kit - mm [in]

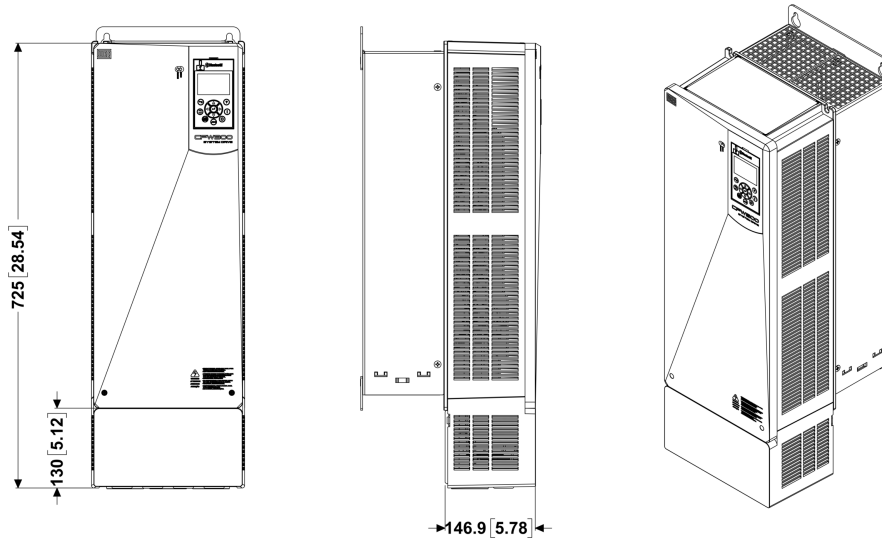
8.4.9 Frames D and E with UL type 1 kit

(a) Frame D with UL Type 1 kit - "CFW900-KN1D" accessory

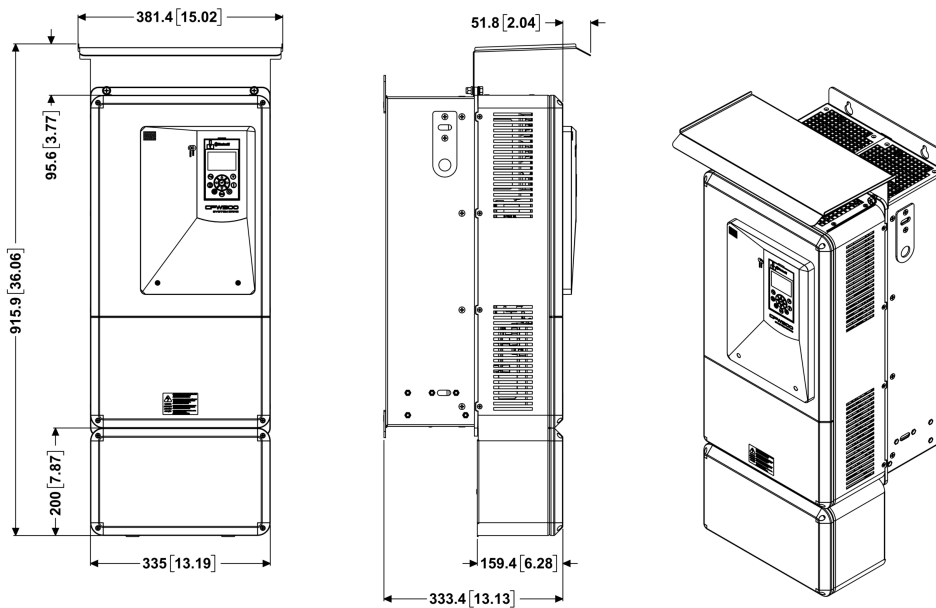

(b) Frame E with UL Type 1 kit - "CFW900-KN1E" accessory

Figure 8.13: Inverter height with UL Type 1 kit - mm [in]



WEG Drives & Controls - Automation LTDA.
Jaraguá do Sul - SC - Brazil
Phone 55 (47) 3276-4000 - Fax 55 (47) 3276-4020
São Paulo - SP - Brazil
Phone 55 (11) 5053-2300 - Fax 55 (11) 5052-4212
automacao@weg.net
www.weg.net