

Frequency Inverter

CFW320 V1.1X

Programming Manual





Programming Manual

CFW320

Software version: 1.1X

Document: 10008951055

Revision: 02

Publication Date: 10/2024

SUMMARY OF REVISIONS

The information below describes the reviews made in this manual.

Version	Revision	Description
1.0X	R00	First Edition
1.0X	R01	Spelling and formatting corrections
1.1X	R02	Revision to new WEG manual branding Section 9.6 DIGITAL INPUTS - Corrected function name and added description New parameter P798 - Enable protocols

CONTENTS

0	QUICK REFERENCE OF PARAMETERS	0-1
1	QUICK REFERENCE OF ALARMS AND FAULTS	1-1
2	SAFETY NOTICES	2-1
2.1	SAFETY NOTICES IN THIS MANUAL	2-1
2.2	SAFETY NOTICES ON THE PRODUCT	2-1
2.3	PRELIMINARY RECOMMENDATIONS	2-1
3	GENERAL INFORMATION	3-1
3.1	TERMINOLOGY AND DEFINITIONS	3-1
3.1.1	Terms and Definitions Used	3-1
3.1.2	Numerical Representation	3-2
3.1.3	Symbols to Describe Parameter Properties	3-2
4	ABOUT THE HMI	4-1
4.1	USE OF THE HMI TO OPERATE THE INVERTER	4-1
4.2	INDICATIONS ON THE HMI DISPLAY	4-1
4.3	OPERATING MODES OF THE HMI	4-1
5	HMI	5-1
5.1	ACCESS	5-1
5.2	INDICATIONS	5-3
6	FREQUENCY INVERTER IDENTIFICATION	6-1
6.1	INVERTER MODEL	6-1
6.2	ACCESSORIES	6-4
7	COMMAND AND REFERENCES	7-1
7.1	REFERENCE SOURCE SELECTION	7-1
7.2	SPEED REFERENCE	7-6
8	MOTOR CONTROL	8-1
8.1	COMMON FUNCTIONS	8-1
8.1.1	Ramps	8-1
8.1.2	Regulation	8-3
8.1.2.1	DC Link Voltage	8-4
8.1.2.1.1	DC Link Voltage Limitation by “Ramp Hold” (P150 = 0 or 2)	8-4
8.1.2.1.2	DC Link Voltage Limitation by “Accelerate Ramp” (P150 = 1 or 3)	8-4
8.1.2.2	Output Current	8-7
8.1.2.2.1	Output Current Limitation by “Ramp Hold” (P150 = 2 or 3)	8-7
8.1.2.2.2	Current Limitation Type “Decelerate Ramp” (P150 = 0 or 1)	8-8
8.1.2.3	Switching Frequency	8-9
8.1.3	Flying Start / Ride-Through	8-10
8.1.4	DC Braking	8-11
8.1.5	Dynamic Braking	8-13
8.1.6	Skip Frequency	8-14
8.1.7	Fire Mode	8-15
8.1.8	Control Configuration	8-17
8.2	V/F	8-19
8.2.1	Energy Saver (EOC)	8-25
8.3	VVW	8-27

9 I/O	9-1
9.1 ANALOG INPUTS	9-1
9.2 EXTERNAL TEMP. SENSOR INPUT	9-5
9.3 SIGNAL POTENTIOMETER INPUT	9-5
9.4 ANALOG OUTPUTS	9-7
9.5 FREQUENCY INPUT	9-10
9.6 DIGITAL INPUTS	9-12
9.7 INPUT FOR INFRARED RECEIVER	9-23
9.8 ENCODER INPUT	9-23
9.9 DIGITAL OUTPUTS	9-24
10 FAULTS AND ALARMS	10-1
10.1 FAULT HISTORY	10-1
10.2 FAULT CONTROL	10-2
10.3 PROTECTIONS	10-3
10.3.1 Inverter	10-3
10.3.1.1 DC Link Voltage Supervision	10-3
10.3.1.2 Temperature control	10-3
10.3.2 Motor	10-3
11 READ	11-1
12 COMMUNICATION	12-1
12.1 COMMANDS AND COMMUNICATION STATUS	12-1
12.2 SERIAL	12-3
12.3 BLUETOOTH	12-4
12.4 BACNET	12-4
12.5 CANOPEN AND DEVICENET	12-5
12.6 PROFIBUS DP	12-8
12.7 ETHERNET	12-10
13 SOFTPLC	13-1
13.1 COMMAND AND STATUS	13-1
13.2 USER	13-2
14 APPLICATIONS	14-1
14.1 PID CONTROLLER	14-1
14.1.1 Start-Up	14-3
14.1.2 Academic PID Controller	14-5
14.1.3 Parameters	14-6
14.1.4 Sleep Mode	14-16
15 APPLICATION EXAMPLES	15-1
15.1 ANALOG INPUT APPLICATIONS	15-1
15.1.1 Application 1 - Nominal speed	15-2
15.1.2 Application 2 - Overspeed	15-3
15.1.3 Application 3 - Forward/Reverse using Analog Input	15-4
15.1.4 Application 4 - Analog input with dead zone	15-5
15.1.5 Application 5 - Reverse reference with Analog input	15-6
15.2 PID CONTROLLER APPLICATION	15-7

0 QUICK REFERENCE OF PARAMETERS

Param.	Function	Adjustable Range	Factory Setting	Prop.	Page
P000	Access to Parameters	0 to 9999	1		5-1
P001	Speed Reference	0 to 9999		ro	11-1
P002	Output Speed (Motor)	0 to 9999		ro	11-1
P003	Motor Current	0.0 to 100.0 A		ro	11-1
P004	DC Link Voltage	0 to 828 V		ro	11-1
P005	Output Frequency (Motor)	0.0 to 400.0 Hz		ro	11-1
P006	Inverter Status	0 = Ready 1 = Run 2 = Undervoltage 3 = Fault 4 = Self-Tuning 5 = Configuration 6 = DC Braking 7 = Reserved 8 = Fire Mode		ro	11-2
P007	Output Voltage	0 to 480 V		ro	11-3
P009	Motor Torque	-200.0 to 200.0 %		ro	11-4
P011	Power Factor	0.00 to 1.00		ro	8-26
P012	DI8 to DI1 Status	0 to FF (hexa) Bit 0 = DI1 Bit 1 = DI2 Bit 2 = DI3 Bit 3 = DI4 Bit 4 = DI5 Bit 5 = DI6 Bit 6 = DI7 Bit 7 = DI8		ro	9-12
P013	DO4 to DO1 Status	0 to F (hexa) Bit 0 = DO1 Bit 1 = DO2 Bit 2 = DO3 Bit 3 = DO4		ro	9-25
P014 (*)	AO1 Value	0.0 to 100.0 %		ro	9-7
P015 (*)	AO2 Value	0.0 to 100.0 %		ro	9-7
P018	AI1 Value	-100.0 to 100.0 %		ro	9-1
P019 (*)	AI2 Value	-100.0 to 100.0 %		ro	9-1
P020 (*)	Potentiometer Signal Value	-100.0 to 100.0 %		ro	9-6
P022	FI Value in Hz	0 to 3000 Hz		ro	9-11
P023	Main SW Version	0.00 to 99.99		ro	6-1
P024 (*)	IO Acces. SW Version	0.00 to 99.99		ro	6-4
P025 (*)	Comm. Acces. SW Version	0.00 to 99.99		ro	6-4
P027	Config. Acces. IO	0 = Without Accessory 1 = CFW320-IOAR 2 = CFW320-IODR 3 = CFW320-IOADR 4 = CFW320-IOAENC 5 = Reserved 6 = CFW320-IODF		ro	6-5
P028	Config. Comm. Acces.	0 = Without Accessory 1 = CFW320-HMIR 2 = Reserved 3 = CFW320-CCAN 4 = CFW320-CPDP 5 = CFW320-CETH 6 = Reserved 7 = CFW320-IOP 8 = CFW320-CBLT		ro	6-5

QUICK REFERENCE OF PARAMETERS

Param.	Function	Adjustable Range	Factory Setting	Prop.	Page
P029	Power HW Configuration	0 = Not identified 1 = 1.6 A/110 Vac 2 = 2.6 A/110 Vac 3 = 4.2 A/110 Vac 4 = 6.0 A/110 Vac 25 = 1.6 A/220 Vac 26 = 2.6 A/220 Vac 27 = 4.2 A/220 Vac 28 = 6.0 A/220 Vac 29 = 7.3 A/220 Vac 30 = 10.0 A/220 Vac 31 = 15.2 A/220 Vac 49 = 1,6 A/ 310 Vdc 50 = 2,6 A/ 310 Vdc 51 = 4,2 A/ 310 Vdc 52 = 6,0 A/ 310 Vdc 53 = 7,3 A/ 310 Vdc 85 = 1.1 A/380 V NB 86 = 1.8 A/380 V NB 87 = 2.6 A/380 V NB 88 = 3.5 A/380 V NB 89 = 4.8 A/380 V NB 90 = 6.5 A/380 V NB 91 = 8.2 A/380 V NB 92 = 10.0 A/380 V NB 93 = 12.0 A/380 V NB 94 = 15.0 A/380 V NB 109 = 1.1 A/380 V DB 110 = 1.8 A/380 V DB 111 = 2.6 A/380 V DB 112 = 3.5 A/380 V DB 113 = 4.8 A/380 V DB 114 = 6.5 A/380 V DB 115 = 8.2 A/380 V DB 116 = 10.0 A/380 V DB 117 = 12.0 A/380 V DB 118 = 15.0 A/380 V DB	According to the Inverter Model	ro	6-2
P030	Module Temperature	-200.0 to 200.0 °C		ro	11-4
P037	Motor Overload lxt	0.0 to 100.0 %		ro	10-4
P038 (*)	Encoder Speed	-9999 to 9999 rpm		ro	9-23
P039 (*)	Encoder Pulses Count	0 to 9999		ro	9-23
P042	Running Time	0.0 to 999.9		ro	11-4
P043	Running Time(h/1000)	0 to 9999		ro	11-4
P045	Fan Enabled Time	0 to FFFF (hexa)		ro	11-5
P047	CONF Status	0 to 33 (Table 11.3 on page 11-6)		ro	11-5
P048	Present Alarm	0 to 999		ro	10-1
P049	Present Fault	0 to 999		ro	10-1
P050	Last Fault	0 to 999		ro	10-1
P051	Current At Last Fault	0.0 to 100.0 A		ro	10-1
P052	DC Link At Last Fault	0 to 828 V		ro	10-1
P053	Frequency At Last Fault	0.0 to 400.0 Hz		ro	10-2
P054	Temperature Last Fault	0.0 to 200.0 °C		ro	10-2
P060	Second Fault	0 to 999		ro	10-1
P070	Third Fault	0 to 999		ro	10-1
P080	Last Fault on Fire Mode	0 to 999		ro	10-2
P081	Second Fault on Fire Mode	0 to 999		ro	10-2
P082	Third Fault on Fire Mode	0 to 999		ro	10-2
P100	Acceleration Time	0.1 to 999.9 s	5.0 s		8-2
P101	Deceleration Time	0.1 to 999.9 s	10.0 s		8-2
P102	Acceleration Time 2nd Ramp	0.1 to 999.9 s	5.0 s		8-2
P103	Deceleration Time 2nd Ramp	0.1 to 999.9 s	10.0 s		8-2
P104	Ramp S	0 = Inactive 1 = Active	0	cfg	8-2
P105	1st / 2nd Ramp Selection	0 = 1st Ramp 1 = 2nd Ramp 2 = Dlx 3 = Serial/USB 4 = Reserved 5 = CO/DN/DP/ETH 6 = SoftPLC	0		8-3

QUICK REFERENCE OF PARAMETERS

Param.	Function	Adjustable Range	Factory Setting	Prop.	Page
P106	Emer. R. Acceleration Time	0.1 to 999.9 s	5.0 s		8-3
P107	Emer. R. Time Deceleration	0.1 to 999.9 s	5.0 s		8-3
P120	Speed Ref. Backup	0 = Inactive 1 = Active 2 = Backup by P121	1		7-7
P121	Reference via HMI	0.0 to 400.0 Hz	3.0 Hz		7-8
P122	JOG Reference	-400.0 to 400.0 Hz	5.0 Hz		7-8
P124	Multispeed Ref. 1	-400.0 to 400.0 Hz	3.0 Hz		7-8
P125	Multispeed Ref. 2	-400.0 to 400.0 Hz	10.0 (5.0) Hz		7-8
P126	Multispeed Ref. 3	-400.0 to 400.0 Hz	20.0 (10.0) Hz		7-8
P127	Multispeed Ref. 4	-400.0 to 400.0 Hz	30.0 (20.0) Hz		7-8
P128	Multispeed Ref. 5	-400.0 to 400.0 Hz	40.0 (30.0) Hz		7-8
P129	Multispeed Ref. 6	-400.0 to 400.0 Hz	50.0 (40.0) Hz		7-9
P130	Multispeed Ref. 7	-400.0 to 400.0 Hz	60.0 (50.0) Hz		7-9
P131	Multispeed Ref. 8	-400.0 to 400.0 Hz	66.0 (55.0) Hz		7-9
P133	Minimum Frequency	0.0 to 400.0 Hz	3.0 Hz		7-10
P134	Maximum Frequency	0.0 to 400.0 Hz	66.0 (55.0) Hz		7-10
P135	Maximum Output Current	0.0 to 100.0 A	1.5 x I _{nom}		8-8
P136	Manual Torque Boost	0.0 to 30.0 %	According to the Inverter Model	V/f	8-22
P137	Automatic Torque Boost	0.0 to 30.0 %	0.0 %	V/f	8-23
P138	Slip Compensation	-10.0 to 10.0 %	0.0 %	V/f	8-23
P139	Output Current Filter	0.000 to 9.999 s	0.050 s		8-9
P140	Slip Com. Filter	0.000 to 9.999 s	0.500 s	VVW	8-32
P142	Maximum Output Voltage	0.0 to 100.0 %	100.0 %	cfg, V/f	8-24
P143	Intermediate Output Voltage	0.0 to 100.0 %	50.0 %	cfg, V/f	8-24
P145	Field Weakening Speed	0.0 to 400.0 Hz	60.0 (50.0) Hz	cfg, V/f	8-24
P146	Intermediate Frequency	0.0 to 400.0 Hz	30.0 (25.0) Hz	cfg, V/f	8-25
P149	DC Link Comp. Mode	0 = Inactive 1 = Standard 2 = Overmodulation 3 = Extended	0	cfg, V/f	8-4
P150	DC/LC Regul. Type	0 = hold_Ud and decel_LC 1 = accel_Ud and decel_LC 2 = hold_Ud and hold_LC 3 = accel_Ud and hold_LC	0	cfg	8-3
P151	DC Link Regul. Level	325 to 810 V	430 V (P296=1) 380 V (P296=2) 781 V (P296=4) 781 V (P296=5) 781 V (P296=6) 781 V (P296=7)		8-6
P153	Dynamic Braking Level	348 to 800 V	According to the Inverter Model		8-13
P156	Rated Speed Overload Current	0.1 to 2.0 x I _{nom}	1.2 x I _{nom}		10-5
P157	Overl.Curr.50 % Speed	0.1 to 2.0 x I _{nom}	1.2 x I _{nom}		10-5
P158	Overl.Curr.20 % Speed	0.1 to 2.0 x I _{nom}	1.2 x I _{nom}		10-5
P178	Rated Flux	50.0 to 150.0 %	100.0 %	V/f, VVW	8-33
P191 (*)	Clear Enc. Pulse Counter	0 = No 1 = Yes	0	cfg	9-24
P200	Password	0 = Inactive 1 = Active 2 to 9999 = New Password	0	cfg	5-2
P202	Type of Control	0 = V/f 1 = Quadratic V/f 2 to 4 = Not Used 5 = VVW	0	cfg	8-1
P204	Load/Save Parameters	0 to 4 = Not Used 5 = Load 60 Hz 6 = Load 50 Hz 7 = Load User 1 8 = Load User 2 9 = Save User 1 10 = Save User 2 11 = Load Default SoftPLC 12 to 13 = Reserved	0	cfg	5-2

QUICK REFERENCE OF PARAMETERS

Param.	Function	Adjustable Range	Factory Setting	Prop.	Page
P205	Main Display Parameter	0 to 999	2		5-3
P207	Bar Graph Parameter	0 to 999	3		5-3
P208	Ref. Scale Factor	1 to 9999	600		5-3
P209	Ref. Eng. Unit	0 to 1 = Without unit 2 = Volt (V) 3 = Hertz (Hz) 4 = Without unit 5 = Percent (%) 6 = Without unit 7 = Rotation/min. (rpm)	3		5-4
P210	Ref. Decimal Point	0 = wxyz 1 = wxy.z 2 = wx.yz 3 = w.xyz	1		5-4
P213	Bar Scale Factor	1 to 9999	1.0 x I _{nom}		5-4
P219	Red. Switch. Freq.	0.0 to 15.0 Hz	15.0 Hz	cfg	8-9
P220	LOC/REM Selection Source	0 = Always Local 1 = Always Remote 2 to 3 = Not Used 4 = DIx 5 = Serial/USB (LOC) 6 = Serial/USB (REM) 7 to 8 = Not Used 9 = CO/DN/DP/ETH (LOC) 10 = CO/DN/DP/ETH (REM) 11 = SoftPLC	0	cfg	7-4
P221	LOC Reference Sel.	0 = HMI 1 = AI1 2 = AI2 3 = Potentiometer 4 = FI 5 = AI1 + AI2 > 0 6 = AI1 + AI2 7 = E.P. 8 = Multispeed 9 = Serial/USB 10 = Not Used 11 = CO/DN/DP/ETH 12 = SoftPLC 13 = Not Used 14 = AI1 > 0 15 = AI2 > 0 16 = Potentiometer > 0 17 = FI > 0	0	cfg	7-4
P222	REM Reference Selection	See options in P221	1	cfg	7-4
P223	LOC FWD/REV Selection	0 = Forward 1 = Reverse 2 to 3 = Not Used 4 = DIx 5 = Serial/USB (FWD) 6 = Serial/USB (REV) 7 to 8 = Not Used 9 = CO/DN/DP/ETH (FWD) 10 = CO/DN/DP/ETH (REV) 11 = Not Used 12 = SoftPLC	0	cfg	7-5
P224	LOC Run/Stop Sel.	0 = HMI Keys 1 = DIx 2 = Serial/USB 3 = Not Used 4 = CO/DN/DP/ETH 5 = SoftPLC	0	cfg	7-5
P225	LOC JOG Selection	0 = Disabled 1 = Not Used 2 = DIx 3 = Serial/USB 4 = Not Used 5 = CO/DN/DP/ETH 6 = SoftPLC	1	cfg	7-6
P226	REM FWD/REV Selection	See options in P223	4	cfg	7-5
P227	REM Run/Stop Selection	See options in P224	1	cfg	7-5
P228	REM JOG Selection	See options in P225	2	cfg	7-6

QUICK REFERENCE OF PARAMETERS

Param.	Function	Adjustable Range	Factory Setting	Prop.	Page
P229	Stop Mode Selection	0 = Ramp to Stop 1 = Coast to Stop	0	cfg	7-6
P230	Dead Zone (Als and FI1)	0 = Inactive 1 = Active	0	cfg	9-1
P231	AI1 Signal Function	0 = Speed Ref. 1 to 3 = Not Used 4 = PTC 5 to 6 = Not Used 7 = PLC Use 8 = Application Function 1 9 = Application Function 2 10 = Application Function 3 11 = Application Function 4 12 = Application Function 5 13 = Application Function 6 14 = Application Function 7 15 = Application Function 8 16 = Control Setpoint 17 = Process Variable	0	cfg	9-2
P232	AI1 Input Gain	0.000 to 9.999	1.000		9-3
P233	AI1 Input Signal	0 = 0 to 10 V / 20 mA 1 = 4 to 20 mA 2 = 10 V / 20 mA to 0 3 = 20 to 4 mA	0		9-3
P234	AI1 Input Offset	-100.0 to 100.0 %	0.0 %		9-4
P235	AI1 Input Filter	0.00 to 16.00 s	0.00 s		9-5
P236 (*)	AI2 Signal Function	See options in P231	0	cfg	9-2
P237 (*)	AI2 Input Gain	0.000 to 9.999	1.000		9-3
P238 (*)	AI2 Input Signal	See options in P233	0		9-3
P239 (*)	AI2 Input Offset	-100.0 to 100.0 %	0.0 %		9-4
P240 (*)	AI2 Input Filter	0.00 to 16.00 s	0.00 s		9-5
P241 (*)	Potentiometer Signal Function	0 = Speed Ref. 1 to 6 = Not Used 7 = SoftPLC 8 = Application Function 1 9 = Application Function 2 10 = Application Function 3 11 = Application Function 4 12 = Application Function 5 13 = Application Function 6 14 = Application Function 7 15 = Application Function 8 16 to 17 = Not Used	0	cfg	9-6
P242 (*)	Potentiometer Signal Gain	0.000 to 9.999	1.000		9-6
P244 (*)	Potentiometer Signal Offset	-100.0 to 100.0 %	0.0 %		9-6
P245	Potentiometer and FI1 Filter	0.00 to 16.00 s	0.00 s		9-6
P246	FI1 Input Function	0 = Inactive 1 = Active in DI1 2 = Active in DI2 3 = Active in DI3 4 = Active in DI4	0	cfg	9-11
P247	FI1 Input Gain	0.000 to 9.999	1.000		9-11
P248	FI1 Minimum Input	1 to 3000 Hz	100 Hz		9-11
P249	FI1 Input Offset	-100.0 to 100.0 %	0.0 %		9-12
P250	FI1 Maximum Input	1 to 3000 Hz	1000 Hz		9-12

QUICK REFERENCE OF PARAMETERS

Param.	Function	Adjustable Range	Factory Setting	Prop.	Page
P251 (*)	AO1 Output Function	0 = Speed Ref. 1 = Not Used 2 = Real Speed 3 to 4 = Not Used 5 = Output Current 6 = Not Used 7 = Active Current 8 to 10 = Not Used 11 = Motor Torque 12 = SoftPLC 13 to 15 = Not Used 16 = Motor Ixt 17 = Not Used 18 = P696 Value 19 = P697 Value 20 = Not Used 21 = Application Function 1 22 = Application Function 2 23 = Application Function 3 24 = Application Function 4 25 = Application Function 5 26 = Application Function 6 27 = Application Function 7 28 = Application Function 8 29 = Control Setpoint 30 = Process Variable	2		9-8
P252 (*)	AO1 Output Gain	0.000 to 9.999	1.000		9-9
P253 (*)	AO1 Output Signal	0 = 0 to 10 V 1 = 0 to 20 mA 2 = 4 to 20 mA 3 = 10 to 0 V 4 = 20 to 0 mA 5 = 20 to 4 mA	0		9-9
P254 (*)	AO2 Output Function	See options in P251	5		9-8
P255 (*)	AO2 Output Gain	0.000 to 9.999	1.000		9-9
P256 (*)	AO2 Output Signal	See options in P253	0		9-9

QUICK REFERENCE OF PARAMETERS

Param.	Function	Adjustable Range	Factory Setting	Prop.	Page
P263	DI1 Input Function	0 = Not Used 1 = Run/Stop 2 = General Enable 3 = Quick Stop 4 = Forward Run 5 = Reverse Run 6 = Start 7 = Stop 8 = Direction of Rotation 9 = LOC/REM 10 = JOG 11 = Accelerate E.P. 12 = Decelerate E.P. 13 = Multispeed 14 = 2nd Ramp 15 to 17 = Not Used 18 = No Ext. Alarm 19 = No Ext. Fault 20 = Reset 21 to 23 = Not Used 24 = Disab. Flying Start 25 = Not Used 26 = Lock Prog. 27 = Load User 1 28 = Load User 2 29 to 31 = Not Used 32 = 2nd Ramp Multispeed 33 = 2nd Ramp Increase E.P. 34 = 2nd Ramp Decrease E.P. 35 = 2nd Ramp FWD Run 36 = 2nd Ramp REV Run 37 = Start / Inc. E.P. 38 = Dec. E.P. / Stop 39 = Stop 40 = Stop (Inactive Pulse) 41 = Application Function 1 42 = Application Function 2 43 = Application Function 3 44 = Application Function 4 45 = Application Function 5 46 = Application Function 6 47 = Application Function 7 48 = Application Function 8 49 = Enable Fire Mode 50 to 54 = Not Used 55 = Run/Stop ON-Lock on power-up 56 = Forward Run ON-Lock on power-up 57 = Reverse Run ON-Lock on power-up	1	cfg	9-14

QUICK REFERENCE OF PARAMETERS

Param.	Function	Adjustable Range	Factory Setting	Prop.	Page
P264	DI2 Input Function	0 = Not Used 1 = Run/Stop 2 = General Enable 3 = Quick Stop 4 = Forward Run 5 = Reverse Run 6 = Start 7 = Stop 8 = Direction of Rotation 9 = LOC/REM 10 = JOG 11 = Accelerate E.P. 12 = Decelerate E.P. 13 = Multispeed 14 = 2nd Ramp 15 to 17 = Not Used 18 = No Ext. Alarm 19 = No Ext. Fault 20 = Reset 21 to 23 = Not Used 24 = Disab.FlyStart 25 = Not Used 26 = Progr. Off 27 = Load User 1 28 = Load User 2 29 to 31 = Not Used 32 = 2nd Ramp Multispeed 33 = 2nd Ramp Increase E.P. 34 = 2nd Ramp Decrease E.P. 35 = 2nd Ramp FWD Run 36 = 2nd Ramp REV Run 37 = Turn ON / Ac. E.P. 38 = De. E.P. / Turn OFF 39 = Stop 40 = Stop (Inactive Pulse) 41 = Application Function 1 42 = Application Function 2 43 = Application Function 3 44 = Application Function 4 45 = Application Function 5 46 = Application Function 6 47 = Application Function 7 48 = Application Function 8 49 = Enable Fire Mode 50 = PID Manual / Automatic 51 to 54 = Not Used 55 = Run/Stop ON-Lock on power-up 56 = Forward Run ON-Lock on power-up 57 = Reverse Run ON-Lock on power-up	8	cfg	9-14

QUICK REFERENCE OF PARAMETERS

Param.	Function	Adjustable Range	Factory Setting	Prop.	Page
P265	DI3 Input Function	0 = Not Used 1 = Run/Stop 2 = General Enable 3 = Quick Stop 4 = Forward Run 5 = Reverse Run 6 = Start 7 = Stop 8 = Direction of Rotation 9 = LOC/REM 10 = JOG 11 = Accelerate E.P. 12 = Decelerate E.P. 13 = Multispeed 14 = 2nd Ramp 15 to 17 = Not Used 18 = No Ext. Alarm 19 = No Ext. Fault 20 = Reset 21 to 23 = Not Used 24 = Disab.FlyStart 25 = Not Used 26 = Lock Prog. 27 = Load User 1 28 = Load User 2 29 to 31 = Not Used 32 = 2nd Ramp Multispeed 33 = 2nd Ramp Increase E.P. 34 = 2nd Ramp Decrease E.P. 35 = 2nd Ramp FWD Run 36 = 2nd Ramp REV Run 37 = Start / Inc. E.P. 38 = Dec. E.P. / Stop 39 = Stop 40 = Stop (Inactive Pulse) 41 = Application Function 1 42 = Application Function 2 43 = Application Function 3 44 = Application Function 4 45 = Application Function 5 46 = Application Function 6 47 = Application Function 7 48 = Application Function 8 49 = Enable Fire Mode 50 = Not Used 51 = Command to Increase the Control Setpoint (EP) 52 = Not Used 53 = 1st DI for Control Setpoint Selection 54 = Not Used 55 = Run/Stop ON-Lock on power-up 56 = Forward Run ON-Lock on power-up 57 = Reverse Run ON-Lock on power-up	0	cfg	9-14

QUICK REFERENCE OF PARAMETERS

Param.	Function	Adjustable Range	Factory Setting	Prop.	Page
P266	DI4 Input Function	0 = Not Used 1 = Run/Stop 2 = General Enable 3 = Quick Stop 4 = Forward Run 5 = Reverse Run 6 = Start 7 = Stop 8 = Direction of Rotation 9 = LOC/REM 10 = JOG 11 = Accelerate E.P. 12 = Decelerate E.P. 13 = Multispeed 14 = 2nd Ramp 15 to 17 = Not Used 18 = No Ext. Alarm 19 = No Ext. Fault 20 = Reset 21 to 23 = Not Used 24 = Disab.FlyStart 25 = Not Used 26 = Progr. Off 27 = Load User 1 28 = Load User 2 29 to 31 = Not Used 32 = 2nd Ramp Multispeed 33 = 2nd Ramp Increase E.P. 34 = 2nd Ramp Decrease E.P. 35 = 2nd Ramp FWD Run 36 = 2nd Ramp REV Run 37 = Start / Inc. E.P. 38 = Dec. E.P. / Stop 39 = Stop 40 = Stop (Inactive Pulse) 41 = Application Function 1 42 = Application Function 2 43 = Application Function 3 44 = Application Function 4 45 = Application Function 5 46 = Application Function 6 47 = Application Function 7 48 = Application Function 8 49 = Enable Fire Mode 50 to 51 = Not Used 52 = Command to Decrease the Control Setpoint (EP) 53 = Not Used 54 = 2nd DI for Control Setpoint Selection 55 = Run/Stop ON-Lock on power-up 56 = Forward Run ON-Lock on power-up 57 = Reverse Run ON-Lock on power-up	0	cfg	9-14
P267 (*)	DI5 Input Function	See options in P263	0	cfg	9-14
P268 (*)	DI6 Input Function	See options in P263	0	cfg	9-14
P269 (*)	DI7 Input Function	See options in P263	0	cfg	9-14
P270 (*)	DI8 Input Function	See options in P263	0	cfg	9-15
P271	DI8 Function	0 = (DI1..DI8) NPN 1 = (DI1..DI4) PNP 2 = (DI5..DI8) PNP 3 = (DI1..DI8) PNP	0	cfg	9-17

QUICK REFERENCE OF PARAMETERS

Param.	Function	Adjustable Range	Factory Setting	Prop.	Page
P275	DO1 Function	0 = Not Used 1 = $F^* \geq F_x$ 2 = $F \geq F_x$ 3 = $F \leq F_x$ 4 = $F = F^*$ 5 = Not Used 6 = $I_s > I_x$ 7 = $I_s < I_x$ 8 = Torque > Tx 9 = Torque < Tx 10 = Remote 11 = Run 12 = Ready 13 = No Fault 14 = No F070 15 = Not Used 16 = No F021/F022 17 = Not Used 18 = No F072 19 = 4-20 mA OK 20 = P695 Value 21 = Forward 22 to 23 = Not Used 24 = Ride-Through 25 = Pre-Charge OK 26 = Fault 27 = Not Used 28 = SoftPLC 29 to 34 = Not Used 35 = No Alarm 36 = Without fault and alarm 37 = Application Function 1 38 = Application Function 2 39 = Application Function 3 40 = Application Function 4 41 = Application Function 5 42 = Application Function 6 43 = Application Function 7 44 = Application Function 8 45 = Fire Mode ON 46 = Low Level of Process Variable 47 = High Level of Process Variable	13		9-25
P276 (*)	DO2 Function	See options in P275	0		9-25
P277 (*)	DO3 Function	See options in P275	0		9-25
P278 (*)	DO4 Function	See options in P275	0		9-26
P281	Fx Frequency	0.0 to 400.0 Hz	3.0 Hz		9-27
P282	Fx Hysteresis	0.0 to 15.0 Hz	0.5 Hz		9-28
P290	Ix Current	0.0 to 100.0 A	1.0 x I _{nom}		9-28
P293	Tx Torque	0 to 200 %	100 %		9-28
P295	Inverter Rated Current	1.1 to 100.0 A	According to the Inverter Model	ro	6-3
P296	Line Rated Voltage	0 = Reserved 1 = 110 - 127 Vac 2 = 200 - 240 Vac 310 Vdc 3 = Reserved 4 = 380 Vac 513 Vdc 5 = 415 Vac 560 Vdc 6 = 440 Vac 594 Vdc 7 = 480 Vac 650 Vdc	According to the Inverter Model	cfg	6-4
P297	Switching Frequency	2.5 to 15.0 kHz	5.0 kHz	cfg	8-10
P299	DC Braking Start Time	0.0 to 15.0 s	0.0 s		8-12
P300	DC Braking Stop Time	0.0 to 15.0 s	0.0 s		8-12
P301	DC Braking Frequency	0.0 to 15.0 Hz	3.0 Hz		8-13
P302	DC Braking Current	0.0 to 100.0 %	20.0 %		8-13
P303	Skip Frequency 1	0.0 to 400.0 Hz	0.0 Hz		8-14
P304	Skip Frequency 2	0.0 to 400.0 Hz	0.0 Hz		8-15
P306	Skip Band	0.0 to 25.0 Hz	0.0 Hz		8-15
P308	Serial Address	1 to 247	1	cfg	12-3

QUICK REFERENCE OF PARAMETERS

Param.	Function	Adjustable Range	Factory Setting	Prop.	Page
P310	Serial Baud Rate	0 = 9600 bits/s 1 = 19200 bits/s 2 = 38400 bits/s 3 = 57600 bits/s 4 = 76800 bits/s	1	cfg	12-3
P311	Serial Bytes Config.	0 = 8 bits, no, 1 1 = 8 bits, even, 1 2 = 8 bits, odd, 1 3 = 8 bits, no, 2 4 = 8 bits, even, 2 5 = 8 bits, odd, 2	1	cfg	12-3
P312	Serial Protocol	0 to 1 = Reserved 2 = Modbus RTU Slave 3 = BACnet 4 = Reserved 5 = ModBus RTU Master	2	cfg	12-3
P313	Action for Communic. Error	0 = Inactive 1 = Ramp Stop 2 = General Disable 3 = Go to LOC 4 = LOC Keep Enab. 5 = Cause Fault	1		12-1
P314	Serial Watchdog	0.0 to 999.0 s	0.0 s	cfg	12-3
P316	Serial Interf. Status	0 = Inactive 1 = Active 2 = Watchdog Error		ro	12-3
P320	Flying Start / Ride-Through	0 = Inactive 1 = Flying Start 2 = FS / RT 3 = Ride-Through	0	cfg	8-10
P331	Voltage Ramp for FS and RT	0.2 to 60.0 s	2.0 s		8-11
P332	Dead Time	0.1 to 10.0 s	1.0 s		8-11
P340	Auto-Reset Time	0 to 255 s	0 s		10-2
P352	Fan Control Config.	0 = OFF 1 = ON 2 = CT	2	cfg	10-3
P358 (*)	Encoder Fault Config.	0 = Inactive 1 = F067 ON 2 = F079 ON 3 = F067 and F079 ON	3	cfg	9-24
P375 (*)	External Sensor Temp.	0 to 200 °C		ro	9-5
P397	Control Config	0 to F (hexa) Bit 0 = Slip Compens. Regen. Bit 1 = Dead Time Comp. Bit 2 = Is Stabilization Bit 3 = P297 reduction in A050	B (hexa)	cfg	8-17
P399	Motor Rated Efficiency	50.0 to 99.9 %	According to the Inverter Model	cfg, VVW	8-33
P400	Motor Rated Voltage	0 to 480 V	220 V	cfg, VVW	8-33
P401	Motor Rated Current	0.0 to 40.0 A	1.0 x I _{nom}	cfg, VVW	8-34
P402	Motor Rated Speed	0 to 24000 rpm	1720 rpm	cfg, VVW	8-34
P403	Motor Rated Frequency	0 to 400 Hz	60 Hz	cfg, VVW	8-34
P404	Motor Rated Power	0 = 0.16 HP (0.12 kW) 1 = 0.25 HP (0.18 kW) 2 = 0.33 HP (0.25 kW) 3 = 0.50 HP (0.37 kW) 4 = 0.75 HP (0.55 kW) 5 = 1.00 HP (0.75 kW) 6 = 1.50 HP (1.10 kW) 7 = 2.00 HP (1.50 kW) 8 = 3.00 HP (2.20 kW) 9 = 4.00 HP (3.00 kW) 10 = 5.00 HP (3.70 kW) 11 = 5.50 HP (4.00 kW) 12 = 6.00 HP (4.50 kW) 13 = 7.50 HP (5.50 kW) 14 = 10.00 HP (7.50 kW)	According to the Inverter Model	cfg, VVW	8-35
P405 (*)	Encoder Pulses Number	32 to 9999	1024	cfg	9-24
P407	Motor Rated Power Factor	0.50 to 0.99	According to the Inverter Model	cfg, VVW	8-26

QUICK REFERENCE OF PARAMETERS

Param.	Function	Adjustable Range	Factory Setting	Prop.	Page
P408	Run Self-Tuning	0 = No 1 = Yes	0	cfg, VVW	8-35
P409	Stator Resistance	0.01 to 99.99	According to the Inverter Model	cfg, V/f, VVW	8-35
P510	SoftPLC Eng. Unit	See options in P209	0		5-4
P511	SoftPLC Indication Form	See options in P210	1		5-4
P580	Fire Mode Configuration	0 = Inactive 1 = Active 2 = Active / P134 3 = Reserved 4 = Active / General Disable	0	cfg	8-17
P582	Fire Mode Auto-reset Adjustable	0 = Limited 1 = Unlimited	0	cfg	8-17
P588	EOC Maximum Torque	0 to 85 %	0 %	cfg, V/f	8-26
P589	EOC Minimum Voltage	40 to 80 %	40 %	cfg, V/f	8-27
P590	EOC Minimum Frequency	12.0 to 400.0 Hz	20.0 Hz	cfg, V/f	8-27
P591	EOC Hysteresis	0 to 30 %	10 %	cfg, V/f	8-27
P613	Main SW Revision	-9999 to 9999		ro	6-4
P680	Logical Status	0 to FFFF (hexa) Bit 0 = Reserved Bit 1 = Run Command Bit 2 = Fire Mode Bit 3 to 4 = Reserved Bit 5 = 2nd Ramp Bit 6 = Config. Mode Bit 7 = Alarm Bit 8 = Running Bit 9 = Enabled Bit 10 = Forward Bit 11 = JOG Bit 12 = Remote Bit 13 = Subvoltage Bit 14 = Reserved Bit 15 = Fault		ro	11-6
P681	13-Bit Speed	0 to FFFF (hexa)		ro	11-7
P682	Serial/USB Control	0 to FFFF (hexa) Bit 0 = Ramp Enable Bit 1 = General Enable Bit 2 = Run Forward Bit 3 = JOG Enable Bit 4 = Remote Bit 5 = 2nd Ramp Bit 6 = Reserved Bit 7 = Fault Reset Bit 8 to 15 = Reserved		ro	12-1
P683	Serial/USB Speed Ref.	0 to FFFF (hexa)		ro	12-2
P684 (*)	CO/DN/DP/ETH Control	0 to FFFF (hexa) Bit 0 = Ramp Enable Bit 1 = General Enable Bit 2 = Run Forward Bit 3 = JOG Enable Bit 4 = Remote Bit 5 = 2nd Ramp Bit 6 = Reserved Bit 7 = Fault Reset Bit 8 to 15 = Reserved		ro	12-1
P685 (*)	CO/DN/DP/ETH Speed Ref	0 to FFFF (hexa)		ro	12-2

QUICK REFERENCE OF PARAMETERS

Param.	Function	Adjustable Range	Factory Setting	Prop.	Page
P690	Logic State 2	0 to FFFF (hexa) Bit 0 to 1 = Reserved Bit 2 = DC Link Voltage Extended Bit 3 = Energy Saver Bit 4 = Fs Reduction Bit 5 = Reserved Bit 6 = Deceleration Ramp Bit 7 = Acceleration Ramp Bit 8 = Freeze Ramp Bit 9 = Setpoint Ok Bit 10 = DC Link Regulation Bit 11 = 50 Hz Config Bit 12 = Ride-Through Bit 13 = Flying Start Bit 14 = DC Braking Bit 15 = PWM pulse		ro	11-8
P695	DOx Value	0 to F (hexa) Bit 0 = DO1 Bit 1 = DO2 Bit 2 = DO3 Bit 3 = DO4		ro	9-28
P696 (*)	AOx Value 1	0 to FFFF (hexa)		ro	9-10
P697 (*)	AOx Value 2	0 to FFFF (hexa)		ro	9-10
P700 (*)	CAN Protocol	1 = CANopen 2 = DeviceNet	2		12-5
P701 (*)	CAN Address	0 to 127	63		12-5
P702 (*)	CAN Baud Rate	0 = 1 Mbps/Auto 1 = Reserved/Auto 2 = 500 Kbps 3 = 250 Kbps 4 = 125 Kbps 5 = 100 Kbps/Auto 6 = 50 Kbps/Auto 7 = 20 Kbps/Auto 8 = 10 Kbps/Auto	0		12-6
P703 (*)	Bus Off Reset	0 = Manual 1 = Automatic	1		12-6
P705 (*)	CAN Controller Status	0 = Disabled 1 = Auto-baud 2 = CAN Active 3 = Warning 4 = Error Passive 5 = Bus Off 6 = No Bus Power		ro	12-6
P706 (*)	RX CAN Telegrams	0 to 9999		ro	12-6
P707 (*)	TX CAN Telegrams	0 to 9999		ro	12-6
P708 (*)	Bus Off Counter	0 to 9999		ro	12-6
P709 (*)	CAN Lost Messages	0 to 9999		ro	12-7
P710 (*)	DeviceNet I/O instances	0 = ODVA Basic 2W 1 = ODVA Extend 2W 2 = Manuf.Spec.2W 3 = Manuf.Spec.3W 4 = Manuf.Spec.4W 5 = Manuf.Spec.5W 6 = Manuf.Spec.6W	0		12-7
P711 (*)	DeviceNet Read Word #3	0 to 1199	0		12-7
P712 (*)	DeviceNet Read Word #4	0 to 1199	0		12-7
P713 (*)	DeviceNet Read Word #5	0 to 1199	0		12-7
P714 (*)	DeviceNet Read Word #6	0 to 1199	0		12-7
P715 (*)	DeviceNet Write Word #3	0 to 1199	0		12-7
P716 (*)	DeviceNet Write Word #4	0 to 1199	0		12-7
P717 (*)	DeviceNet Write Word #5	0 to 1199	0		12-7
P718 (*)	DeviceNet Write Word #6	0 to 1199	0		12-7
P719 (*)	DeviceNet Network Status	0 = Offline 1 = OnLine, Not Conn 2 = OnLine, Connect. 3 = Connection Timed out 4 = Link Failure 5 = Auto-Baud		ro	12-7

QUICK REFERENCE OF PARAMETERS

Param.	Function	Adjustable Range	Factory Setting	Prop.	Page
P720 (*)	DeviceNet Master Status	0 = Run 1 = Idle		ro	12-8
P721 (*)	CANopen Comm. Status	0 = Disabled 1 = Reserved 2 = Communic. Enabled 3 = Error Ctrl. Enable 4 = Guarding Error 5 = Heartbeat Error		ro	12-8
P722 (*)	CANopen Node Status	0 = Disabled 1 = Initialization 2 = Stopped 3 = Operational 4 = Preoperational		ro	12-8
P740 (*)	Profibus Comm. Status	0 = Disabled 1 = Access Error 2 = Offline 3 = Config. Error 4 = Param. Error 5 = Clear Mode 6 = Online		ro	12-8
P742 (*)	Profibus Read Word #3	0 to 1199	0		12-8
P743 (*)	Profibus Read Word #4	0 to 1199	0		12-8
P744 (*)	Profibus Read Word #5	0 to 1199	0		12-9
P745 (*)	Profibus Read Word #6	0 to 1199	0		12-9
P746 (*)	Profibus Write Word#3	0 to 1199	0		12-9
P747 (*)	Profibus Write Word#4	0 to 1199	0		12-9
P748 (*)	Profibus Write Word#5	0 to 1199	0		12-9
P749 (*)	Profibus Write Word#6	0 to 1199	0		12-9
P750 (*)	Profibus Address	1 to 126	1		12-9
P751 (*)	Profibus Teleg. Sel.	1 = Std. Teleg. 1 2 = Telegram 100 3 = Telegram 101 4 = Telegram 102 5 = Telegram 103	1		12-9
P754 (*)	Profibus Baud Rate	0 = 9.6 kbit/s 1 = 19.2 kbit/s 2 = 93.75 kbit/s 3 = 187.5 kbit/s 4 = 500 kbit/s 5 = Not Detected 6 = 1500 kbit/s 7 = 3000 kbit/s 8 = 6000 kbit/s 9 = 12000 kbit/s 10 = Reserved 11 = 45.45 kbit/s	0		12-9
P760	BACnet Dev Inst Hi	0 to 419	0		12-4
P761	BACnet Dev Inst Lo	0 to 9999	0		12-4
P762	Max Number of master	0 to 127	127		12-5
P763	MS/TP Max info Frame	0 to FFFF (hexa)	1 (hexa)		12-5
P764	I-AM Msg transmittion	0 = Power Up 1 = Continuous	0		12-5
P765	Token RX Quantity	0 to FFFF (hexa)		ro	12-5
P770 (*)	Bluetooth Device Name	0 to 9999	Serial Number of the Inverter		12-4
P771 (*)	Bluetooth Password PIN	0 to 9999	1234		12-4
P798 (*)	Enable protocols	0 to 1 (hexa) Bit 0 = Web Server	0 (hexa)		12-10
P840 (*)	IR Control Command	0 to FFFF (hexa)		ro	9-23
P841 (*)	IR Controle Selection	0 = Without Display 1 = With Display	0	cfg	9-23
P842 (*)	Quick View 1 IR	0 to 959	2		5-4
P843 (*)	Quick View 2 IR	0 to 959	375		5-4
P850 (*)	IP Address Config	0 = Parameters 1 = DHCP	1	cfg	12-10
P851 (*)	IP Address 1	0 to 255	192	cfg	12-10
P852 (*)	IP Address 2	0 to 255	168	cfg	12-10
P853 (*)	IP Address 3	0 to 255	0	cfg	12-10

QUICK REFERENCE OF PARAMETERS

Param.	Function	Adjustable Range	Factory Setting	Prop.	Page
P854 (*)	IP Address 4	0 to 255	10	cfg	12-10
P855 (*)	CIDR Sub-net	0 = Reserved 1 = 128.0.0.0 2 = 192.0.0.0 3 = 224.0.0.0 4 = 240.0.0.0 5 = 248.0.0.0 6 = 252.0.0.0 7 = 254.0.0.0 8 = 255.0.0.0 9 = 255.128.0.0 10 = 255.192.0.0 11 = 255.224.0.0 12 = 255.240.0.0 13 = 255.248.0.0 14 = 255.252.0.0 15 = 255.254.0.0 16 = 255.255.0.0 17 = 255.255.128.0 18 = 255.255.192.0 19 = 255.255.224.0 20 = 255.255.240.0 21 = 255.255.248.0 22 = 255.255.252.0 23 = 255.255.254.0 24 = 255.255.255.0 25 = 255.255.255.128 26 = 255.255.255.192 27 = 255.255.255.224 28 = 255.255.255.240 29 = 255.255.255.248 30 = 255.255.255.252 31 = 255.255.255.254	24	cfg	12-11
P856 (*)	Gateway 1	0 to 255	0	cfg	12-11
P857 (*)	Gateway 2	0 to 255	0	cfg	12-12
P858 (*)	Gateway 3	0 to 255	0	cfg	12-12
P859 (*)	Gateway 4	0 to 255	0	cfg	12-12
P860 (*)	MBTCP: Communication Status	0 = Disabled 1 = No connection 2 = Connected 3 = Timeout Error		ro	12-12
P863 (*)	MBTCP: Active Connections	0 to 4		ro	12-12
P865 (*)	MBTCP: TCP Port	0 to 9999	502	cfg	12-12
P868 (*)	MBTCP: Timeout	0.0 to 999.9 s	0.0 s	cfg	12-12
P869 (*)	EIP: Master Status	0 = Run 1 = Idle		ro	12-13
P870 (*)	EIP: Communication Status	0 = Disabled 1 = No connection 2 = Connected 3 = Timeout in I/O Connection 4 = Reserved		ro	12-13
P871 (*)	EIP: Data Profile	0 to 3 = Reserved 4 = 120/170: CIP Basic Speed + I/O 5 = 121/171: CIP Extended Speed + I/O 6 to 7 = Reserved 8 = 100/150: Manufac. Speed + I/O 9 to 10 = Reserved	8	cfg	12-13
P872 (*)	Ethernet Read Word #3	0 to 9999	0		12-13
P873 (*)	Ethernet Read Word #4	0 to 9999	0		12-13
P874 (*)	Ethernet Read Word #5	0 to 9999	0		12-13
P875 (*)	Ethernet Read Word #6	0 to 9999	0		12-13
P876 (*)	Ethernet Read Word #7	0 to 9999	0		12-13
P877 (*)	Ethernet Read Word #8	0 to 9999	0		12-13
P880 (*)	Ethernet Write Word #3	0 to 9999	0		12-13
P881 (*)	Ethernet Write Word #4	0 to 9999	0		12-13
P882 (*)	Ethernet Write Word #5	0 to 9999	0		12-13
P883 (*)	Ethernet Write Word #6	0 to 9999	0		12-13
P884 (*)	Ethernet Write Word #7	0 to 9999	0		12-14
P885 (*)	Ethernet Write Word #8	0 to 9999	0		12-14

QUICK REFERENCE OF PARAMETERS

Param.	Function	Adjustable Range	Factory Setting	Prop.	Page
P889 (*)	Ethernet Interface Status	0 to 3 (hexa) Bit 0 = Link 1 Bit 1 = Link 2		ro	12-14
P900	SoftPLC Status	0 = No Application 1 = Installing Application 2 = Incompat. Application 3 = Application Stopped 4 = Application Running		ro	13-1
P901	SoftPLC Command	0 = Stop Application 1 = Run Application	0		13-1
P902	Scan Cycle Time	0.000 to 9.999 s		ro	13-1
P903	SoftPLC Appl.	0 = User 1 = PID Controller	1	cfg	13-1
P904	Action for SoftPLC Application not Running	0 = Disabled 1 = Cause Alarm (A708) 2 = Cause Fault (F709)	0		13-2
P910	SoftPLC Parameter 1	-9999 to 9999	0		13-2
P911	SoftPLC Parameter 2	-9999 to 9999	0		13-2
P912	SoftPLC Parameter 3	-9999 to 9999	0		13-2
P913	SoftPLC Parameter 4	-9999 to 9999	0		13-2
P914	SoftPLC Parameter 5	-9999 to 9999	0		13-2
P915	SoftPLC Parameter 6	-9999 to 9999	0		13-2
P916	SoftPLC Parameter 7	-9999 to 9999	0		13-2
P917	SoftPLC Parameter 8	-9999 to 9999	0		13-2
P918	SoftPLC Parameter 9	-9999 to 9999	0		13-2
P919	SoftPLC Parameter 10	-9999 to 9999	0		13-2
P920	SoftPLC Parameter 11	-9999 to 9999	0		13-2
P921	SoftPLC Parameter 12	-9999 to 9999	0		13-2
P922	SoftPLC Parameter 13	-9999 to 9999	0		13-2
P923	SoftPLC Parameter 14	-9999 to 9999	0		13-3
P924	SoftPLC Parameter 15	-9999 to 9999	0		13-3
P925	SoftPLC Parameter 16	-9999 to 9999	0		13-3
P926	SoftPLC Parameter 17	-9999 to 9999	0		13-3
P927	SoftPLC Parameter 18	-9999 to 9999	0		13-3
P928	SoftPLC Parameter 19	-9999 to 9999	0		13-3
P929	SoftPLC Parameter 20	-9999 to 9999	0		13-3
P930	SoftPLC Parameter 21	-9999 to 9999	0		13-3
P931	SoftPLC Parameter 22	-9999 to 9999	0		13-3
P932	SoftPLC Parameter 23	-9999 to 9999	0		13-3
P933	SoftPLC Parameter 24	-9999 to 9999	0		13-3
P934	SoftPLC Parameter 25	-9999 to 9999	0		13-3
P935	SoftPLC Parameter 26	-9999 to 9999	0		13-3
P936	SoftPLC Parameter 27	-9999 to 9999	0		13-3
P937	SoftPLC Parameter 28	-9999 to 9999	0		13-3
P938	SoftPLC Parameter 29	-9999 to 9999	0		13-3
P939	SoftPLC Parameter 30	-9999 to 9999	0		13-3
P940	SoftPLC Parameter 31	-9999 to 9999	0		13-3
P941	SoftPLC Parameter 32	-9999 to 9999	0		13-3
P942	SoftPLC Parameter 33	-9999 to 9999	0		13-3
P943	SoftPLC Parameter 34	-9999 to 9999	0		13-3
P944	SoftPLC Parameter 35	-9999 to 9999	0		13-3
P945	SoftPLC Parameter 36	-9999 to 9999	0		13-3
P946	SoftPLC Parameter 37	-9999 to 9999	0		13-3
P947	SoftPLC Parameter 38	-9999 to 9999	0		13-4
P948	SoftPLC Parameter 39	-9999 to 9999	0		13-4
P949	SoftPLC Parameter 40	-9999 to 9999	0		13-4
P950	SoftPLC Parameter 41	-9999 to 9999	0		13-4
P951	SoftPLC Parameter 42	-9999 to 9999	0		13-4
P952	SoftPLC Parameter 43	-9999 to 9999	0		13-4
P953	SoftPLC Parameter 44	-9999 to 9999	0		13-4
P954	SoftPLC Parameter 45	-9999 to 9999	0		13-4
P955	SoftPLC Parameter 46	-9999 to 9999	0		13-4

QUICK REFERENCE OF PARAMETERS

Param.	Function	Adjustable Range	Factory Setting	Prop.	Page
P956	SoftPLC Parameter 47	-9999 to 9999	0		13-4
P957	SoftPLC Parameter 48	-9999 to 9999	0		13-4
P958	SoftPLC Parameter 49	-9999 to 9999	0		13-4
P959	SoftPLC Parameter 50	-9999 to 9999	0		13-4
P960	SoftPLC Parameter 51	-9999 to 9999	0		13-4
P961	SoftPLC Parameter 52	-9999 to 9999	0		13-4
P962	SoftPLC Parameter 53	-9999 to 9999	0		13-4
P963	SoftPLC Parameter 54	-9999 to 9999	0		13-4
P964	SoftPLC Parameter 55	-9999 to 9999	0		13-4
P965	SoftPLC Parameter 56	-9999 to 9999	0		13-4
P966	SoftPLC Parameter 57	-9999 to 9999	0		13-4
P967	SoftPLC Parameter 58	-9999 to 9999	0		13-4
P968	SoftPLC Parameter 59	-9999 to 9999	0		13-4
P969	SoftPLC Parameter 60	-9999 to 9999	0		13-4
P970	SoftPLC Parameter 61	-9999 to 9999	0		13-4
P971	SoftPLC Parameter 62	-9999 to 9999	0		13-5
P972	SoftPLC Parameter 63	-9999 to 9999	0		13-5
P973	SoftPLC Parameter 64	-9999 to 9999	0		13-5
P974	SoftPLC Parameter 65	-9999 to 9999	0		13-5
P975	SoftPLC Parameter 66	-9999 to 9999	0		13-5
P976	SoftPLC Parameter 67	-9999 to 9999	0		13-5
P977	SoftPLC Parameter 68	-9999 to 9999	0		13-5
P978	SoftPLC Parameter 69	-9999 to 9999	0		13-5
P979	SoftPLC Parameter 70	-9999 to 9999	0		13-5

SoftPLC Parameter Configuration for PID Controller Application (P903 = 1)

Param.	Function	Adjustable Range	Factory Setting	Prop.	Page
P910	PID Controller Application Version	0.00 to 90.00		ro	13-2
P911	Control Setpoint	-99.99 to 99.99	2.00		13-2
P912	Control Setpoint 1	-99.99 to 99.99	2.00		13-2
P913	Control Setpoint 2	-99.99 to 99.99	2.30		13-2
P914	Control Setpoint 3	-99.99 to 99.99	1.80		13-2
P915	Control Setpoint 4	-99.99 to 99.99	1.60		13-2
P916	Control Process Variable	-99.99 to 99.99		ro	13-2
P917	PID Controller Output	0.0 to 100.0 %		ro	13-2
P918	PID Controller Setpoint in Manual Mode	0.0 to 400.0 Hz	0.0 Hz		13-2
P919	PID Controller Logical Status	0 to FFFF (hexa) Bit 0 = Sleep Mode Active (A750) Bit 1 = PID in Manual (0) / Automatic (1) Bit 2 = PV Low Level (A760) Bit 3 = PV Low Level (F761) Bit 4 = PV High Level (A762) Bit 5 = PV High Level (F763) Bit 6 to 15 = Reserved		ro	13-2
P920	Selection of the Control Setpoint Source	0 = Control Setpoint via HMI or Communication Networks (P911) 1 = Control Setpoint via Analog Input AI1 2 = Control Setpoint via Analog Input AI2 3 = Control Setpoint via Electronic Potentiometer (EP) 4 = Two Setpoints via Digital Input DI3 (P912 and P913) 5 = Three Setpoints via Digital Inputs DI3 and DI4 (P912, P913 and P914) 6 = Four Setpoints via Digital Inputs DI3 and DI4 (P912, P913, P914 and P915)	0	cfg	13-2

QUICK REFERENCE OF PARAMETERS

SoftPLC Parameter Configuration for PID Controller Application (P903 = 1)					
Param.	Function	Adjustable Range	Factory Setting	Prop.	Page
P921	Selection of the Control Process Variable Source	1 = Control Process Variable via Analog Input AI1 2 = Control Process Variable via Analog Input AI2 3 = Control Process Variable via Difference between Analog Input AI1 and AI2	1	cfg	13-2
P922	Minimum Sensor Level of the Control Process Variable	-99.99 to 99.99	0.00		13-2
P923	Maximum Sensor Level of the Control Process Variable	-99.99 to 99.99	4.00		13-3
P924	Value for Low Level Alarm for the Control Process Variable	-99.99 to 99.99	1.00		13-3
P925	Time for Low Level Fault for the Control Process Variable	0.0 to 999.9 s	0.0 s		13-3
P926	Value for High Level Alarm for the Control Process Variable	-99.99 to 99.99	3.50		13-3
P927	Time for High Level Fault for the Control Process Variable	0.0 to 999.9 s	0.0 s		13-3
P928	Selection of the PID Controller Control Action	0 = Disable PID Controller 1 = Enable PID Controller in Direct Mode 2 = Enable PID Controller in Reverse Mode	0	cfg	13-3
P929	PID Controller Operation Mode	0 = Manual 1 = Automatic 2 = Select Control to Manual (0) or Automatic (1) via digital input DI2	2		13-3
P930	Automatic Adjustment of the PID Controller Setpoint	0 = P911 inactive and P918 inactive 1 = P911 active and P918 inactive 2 = P911 inactive and P918 active 3 = P911 active and P918 active	0		13-3
P931	Proportional Gain	0.00 to 99.99	1.00		13-3
P932	Integral Gain	0.00 to 99.99	5.00		13-3
P933	Derivative Gain	0.00 to 99.99	0.00		13-3
P934	PID Controller Sampling Period	0.050 to 9.999 s	0.100 s	cfg	13-3
P935	Filter for the PID Controller Control Setpoint	0.000 to 9.999 s	0.150 s		13-3
P936	Deviation of the Control Process Variable to Wake Up	-99.99 to 99.99	0.30		13-3
P937	Time to Wake Up	0.0 to 999.9 s	5.0 s		13-3
P938	Motor Speed to activate the Sleep Mode	0.0 to 400.0 Hz	0.0 Hz		13-3
P939	Time to activate de Sleep Mode	0.0 to 999.9 s	10.0 s		13-3

Notes:

(*) Only available when IO or communication expansion accessory is present (connected). For further information, refer to the respective accessory guide.

ro = Read only parameter

cfg = Configuration parameter, value can be programmed only with motor stopped

V/f = Available when V/f control mode is chosen

VVW = Available when VVW control mode is chosen

1 QUICK REFERENCE OF ALARMS AND FAULTS

Fault / Alarm	Description	Possible Causes
F021 Undervoltage on the DC Link	Undervoltage fault on the intermediate circuit.	<ul style="list-style-type: none"> ■ Wrong voltage supply; check if the data on the inverter label comply with the power supply and parameter P296. ■ Supply voltage too low, producing voltage on the DC Link below the minimum value (Level F021) according to: <ul style="list-style-type: none"> - Ud < 200 Vdc (Supply voltage 110 to 127 Vac - P296 = 1) - Ud < 200 Vdc (Supply voltage 200 to 240 Vac - P296 = 2) - Ud < 385 Vdc (Supply voltage 380 Vac - P296 = 4) - Ud < 405 Vdc (Supply voltage 400 to 415 Vac - P296 = 5) - Ud < 446 Vdc (Supply voltage 440 to 460 Vac - P296 = 6) - Ud < 486 Vdc (Supply voltage 480 Vac - P296 = 7) ■ Phase fault in the input. ■ Fault in the pre-charge circuit.
F022 Overvoltage on the DC Link	Overvoltage fault on the intermediate circuit.	<ul style="list-style-type: none"> ■ Wrong voltage supply; check if the data on the inverter label comply with the power supply and parameter P296. ■ Supply voltage is too high, producing voltage on the DC Link above the maximum value (Level F022) according to: <ul style="list-style-type: none"> - Ud > 460 Vdc (Supply voltage 110 to 127 Vac - P296 = 1) - Ud > 410 Vdc (Supply voltage 200 to 240 Vac - P296 = 2) - Ud > 800 Vdc (Supply voltage 380 to 480 Vac - P296 = 4, 5, 6 or 7) ■ Load inertia is too high or deceleration ramp is too fast. ■ P151 setting is too high.
F031 Fault in Communication with Expansion Accessory	Main control cannot establish the communication link with the IOs expansion accessory.	<ul style="list-style-type: none"> ■ Accessory damaged. ■ Poor connection of the accessory. ■ Problem in the identification of the accessory; refer to P027.
F032 Comm. Plug-in module communication Lost	Main control cannot establish the communication link with the communication accessory.	<ul style="list-style-type: none"> ■ Accessory damaged. ■ Poor connection of the accessory. ■ Problem in the identification of the accessory; refer to P028.
F033 VW Self-tuning Fault	Stator resistance setting fault P409.	<ul style="list-style-type: none"> ■ Stator resistance value in P409 does not comply with the inverter power. ■ Motor connection error; turn off the power supply and check the motor terminal box and the connections with the motor terminals. ■ Motor power too low or too high in relation to the inverter.
A046 Motor Overload	Motor overload alarm.	<ul style="list-style-type: none"> ■ Settings of P156 is too low for the used motor. ■ Overload on the motor shaft.
A050 IGBTs Overtemperatures	Overtemperature alarm from the power module temperature sensor (NTC).	<ul style="list-style-type: none"> ■ High temperature at IGBTs. P030 > Level A050, according to: <ul style="list-style-type: none"> Line 200V <ul style="list-style-type: none"> - P030 > 90 °C (194 °F) (Frame size A) - P030 > 116 °C (248 °F) (Frame size B) Line 400V <ul style="list-style-type: none"> - P030 > 100 °C (212 °F) (Frame size A, B and C) ■ High ambient temperature around the inverter and high output current. For further information, refer to of the user's manual available for download on the website: www.weg.net. ■ Blocked or defective fan. ■ Heatsink is too dirty, preventing the air flow.
F051 IGBTs Overtemperatures	Overtemperature fault measured on the temperature sensor of the power pack.	<ul style="list-style-type: none"> ■ High temperature at IGBTs. P030 > Level F051, according to: <ul style="list-style-type: none"> Line 200V <ul style="list-style-type: none"> - P030 > 100 °C (212 °F) (Frame size A) - P030 > 126 °C (258 °F) (Frame size B) Line 400V <ul style="list-style-type: none"> - P030 > 110 °C (222 °F) (Frame size A, B and C) ■ High ambient temperature around the inverter and high output current. For further information, refer to of the user's manual available for download on the website: www.weg.net. ■ Blocked or defective fan. ■ Heatsink is too dirty, preventing the air flow.

QUICK REFERENCE OF ALARMS AND FAULTS

Fault / Alarm	Description	Possible Causes
F067 Incorrect Encoder/ Motor Wiring	Fault related to the phase relation of the encoder signals.	<ul style="list-style-type: none"> ■ Output motor cables U, V, W are inverted. ■ Encoder channels A and B are inverted. ■ Encoder was not properly mounted.
F070 Overcurrent/Shortcircuit	Overcurrent or short-circuit on the output, DC Link or braking resistor.	<ul style="list-style-type: none"> ■ Short-circuit between two motor phases. ■ IGBTs module in short-circuit or damaged. ■ Start with too short acceleration ramp. ■ Start with motor spinning without the Flying Start function.
F072 Motor Overload	Motor overload fault.	<ul style="list-style-type: none"> ■ P156, P157 or P158 setting is too low in relation to the motor operating current. ■ Overload on the motor shaft.
F078 Motor Overtemperature	Overtemperature fault measured on the motor temperature sensor (Triple PTC) via analog input AIx	<ul style="list-style-type: none"> ■ Overload on the motor shaft. ■ Load cycle is too high (high number of starts and stops per minute). ■ High ambient temperature around the motor. ■ Poor contact or short-circuit ($3k9 < R_{PTC} < 0k1$). ■ Motor thermistor not installed. ■ Motor shaft is stuck.
F079 Encoder Signal Fault	Fault of encoder signals absent.	<ul style="list-style-type: none"> ■ Wiring between encoder and interface accessory to encoder broken. ■ Encoder defective.
F080 CPU Fault (Watchdog)	Fault related to the supervision algorithm of the inverter main CPU.	<ul style="list-style-type: none"> ■ Electric noise. ■ Inverter firmware fault.
F081 End of User's Memory	Fault of end of memory to save user's parameter table.	<ul style="list-style-type: none"> ■ Attempt to save (P204 = 9) more than 32 parameters (with values different from the factory default) on the User parameter table.
F082 Fault in Data Transfer (MMF)	Fault in data transfer using MMF accessory.	<ul style="list-style-type: none"> ■ Attempt to download data from the flash memory module to the inverter with the inverter energized. ■ Attempt to download a SoftPLC application incompatible with the destination inverter. ■ Problems saving data downloaded to the inverter.
F084 Auto-diagnosis Fault	Fault related to the automatic identification algorithm of the inverter hardware.	<ul style="list-style-type: none"> ■ Poor contact in the connection between the main control and the power pack. ■ Hardware not compatible with the firmware version. ■ Defect on the internal circuits of the inverter.
A090 External Alarm	External alarm via DIx (option "no external alarm" in P263 to P270).	<ul style="list-style-type: none"> ■ Wiring on DI1 to DI8 inputs are open or have poor contact.
F091 External Fault	External fault via DIx ("no external fault" in P263 to P270).	<ul style="list-style-type: none"> ■ Wiring on DI1 to DI8 inputs are open or have poor contact.
A128 Telegram Reception Timeout	It indicates that the device stopped receiving valid telegrams for a period longer than the setting in P314. The time counting starts as soon as it receives the first valid telegram, with correct address and error-checking field.	<ul style="list-style-type: none"> ■ Check network installation, broken cable or fault/poor contact on the connections with the network, grounding. ■ Ensure the master always sends telegrams to the equipment in a time shorter than the setting in P314. ■ Disable this function in P314.
A133 No Power Supply on the CAN Interface	It indicates that the CAN interface has no power supply between pins 25 and 29 of the connector.	<ul style="list-style-type: none"> ■ Measure if there is voltage within the allowed range between pins 25 and 29 of the CAN interface connector. ■ Check if the power supply cables are not misconnected or inverted. ■ Check for contact problems on the cable or connector of the CAN interface.
A134 Bus Off	Bus off error detected on the CAN interface.	<ul style="list-style-type: none"> ■ Check for short circuit on the CAN circuit transmission cable. ■ Check if the cables are not misconnected or inverted. ■ Check if all the network devices use the same baud rate. ■ Check if the termination resistors with the right specification were installed only at the end of the main bus. ■ Check if the CAN network was properly installed.
A135 Node Guarding/ Heartbeat	CANopen communication error control detected communication error using the guarding mechanism.	<ul style="list-style-type: none"> ■ Check the times set on the master and on the slave for message exchange. In order to prevent problems due to transmission delays and time counting, it is recommended that the values set for error detection by the slave be multiples of the times set for message exchange on the master. ■ Check if the master is sending the guarding telegrams in the time set. ■ Check problems in the communication that may cause missing telegrams or transmission delays.

QUICK REFERENCE OF ALARMS AND FAULTS

Fault / Alarm	Description	Possible Causes
A136 Idle Master	Alarm indicates that the DeviceNet network master is in Idle mode.	<ul style="list-style-type: none"> ■ Set the switch that controls the master operation of the master for Run or the corresponding bit on the configuration word of the master software. If further information is needed, refer to the documentation of the master used.
A137 DeviceNet Connection Timeout	Alarm that indicates that one or more DeviceNet connections timed out.	<ul style="list-style-type: none"> ■ Check the network master status. ■ Check network installation, broken cable or fault/poor contact on the connections with the network.
A138 Profibus DP Interface in Clear Mode	It indicates that the inverter received the command from the Profibus DP network master to go into clear mode.	<ul style="list-style-type: none"> ■ Check the network master status, ensuring it is in the run mode.
A139 Offline Profibus DP Interface	It indicates interruption in the communication between the Profibus DP network master and the inverter. The Profibus DP communication interface went into offline status.	<ul style="list-style-type: none"> ■ Check if the network master is correctly configured and operating properly. ■ Check for short-circuit or poor contact on the communication cables. ■ Check if the cables are not misconnected or inverted. ■ Check if the termination resistors with the right value were installed only at the end of the main bus. ■ Check the network installation in general - cabling, grounding.
A140 Profibus DP Module Access Error	It indicates error in the access to the Profibus DP communication module data.	<ul style="list-style-type: none"> ■ Check if the Profibus DP module is correctly fitted. ■ Hardware errors due to improper handling or installation of the accessory, for instance, may cause this error. If possible, carry out tests by replacing the communication accessory.
A147 EtherNet/IP Communication Offline	It indicates interruption in the cyclic communication with EtherNet/IP master. It occurs when, for any reason, after the cyclic communication of the master with the product is started, this communication is interrupted.	<ul style="list-style-type: none"> ■ Check the status of the network master. ■ Check the network installation, broken cable or failed/bad contact in the network connections.
A149 Timeout Modbus TCP	It indicates that the device stopped receiving valid telegrams for a period longer than the setting in P868. The time counting starts as soon as it receives the first valid telegram.	<ul style="list-style-type: none"> ■ Check network installation, broken cable or fault/poor contact on the connections with the network, grounding. ■ Ensure the Modbus TCP client always sends telegrams to the equipment in a time shorter than the setting in P868. ■ Disable this function in P868.
A163 Signal Fault AI1 4...20 mA	Analog input signal AI1 at 4 to 20 mA or 20 to 4 mA is below 2 mA.	<ul style="list-style-type: none"> ■ Current signal on the analog input AI1 interrupted or null. ■ Parameterization error on analog input AI1.
A164 Signal Fault AI2 4...20 mA	Analog input signal AI2 at 4 to 20 mA or 20 to 4 mA is below 2 mA.	<ul style="list-style-type: none"> ■ Current signal on the analog input AI2 interrupted or null. ■ Parameterization error on analog input AI2.
A177 Replace Fan	Alarm to replace the fan (P045 > 50000 hours).	<ul style="list-style-type: none"> ■ Maximum number of operation hours of the heatsink fan exceeded.
F182 Pulse Feedback Failure	Pulse feedback circuit fault of the output voltage. Note: it may be turned off in P397.	<ul style="list-style-type: none"> ■ Hardware identification fault; compare P295 and P296 to the inverter identification label. ■ Inverter internal pulse feedback circuit fault.
A211 Drive in Fire Mode	Indicates that the drive is in Fire Mode.	<ul style="list-style-type: none"> ■ The digital input programmed for activating the Fire Mode is active.
F228 Timeout in Receipt of Telegrams	It indicates that the device stopped receiving valid telegrams for a period longer than the setting in P314. The time counting starts as soon as it receives the first valid telegram, with correct address and error-checking field.	<ul style="list-style-type: none"> ■ Check network installation, broken cable or fault/poor contact on the connections with the network, grounding. ■ Ensure the master always sends telegrams to the equipment in a time shorter than the setting in P314. ■ Disable this function in P314.
F233 No Power Supply on the CAN Interface	It indicates that the CAN interface has no power supply between pins V(-) and V(+) of the connector.	<ul style="list-style-type: none"> ■ Measure if there is voltage within the allowed range between pins V(-) and V(+) of the CAN interface connector. ■ Check if the power supply cables are not misconnected or inverted. ■ Check for contact problems on the cable or connector of the CAN interface.

QUICK REFERENCE OF ALARMS AND FAULTS

Fault / Alarm	Description	Possible Causes
F234 Bus Off	Bus off error detected on the CAN interface.	<ul style="list-style-type: none"> ■ Check for short circuit on the CAN circuit transmission cable. ■ Check if the cables are not misconnected or inverted. ■ Check if all the network devices use the same baud rate. ■ Check if the termination resistors with the right specification were installed only at the end of the main bus. ■ Check if the CAN network was properly installed.
F235 Node Guarding/ Heartbeat	CANopen communication error control detected communication error using the guarding mechanism.	<ul style="list-style-type: none"> ■ Check the times set on the master and on the slave for message exchange. In order to prevent problems due to transmission delays and time counting, it is recommended that the values set for error detection by the slave be multiples of the times set for message exchange on the master. ■ Check if the master is sending the guarding telegrams in the time set. ■ Check problems in the communication that may cause missing telegrams or transmission delays.
F236 Idle Master	Fault indicates that the DeviceNet network master is in Idle mode.	<ul style="list-style-type: none"> ■ Set the switch that controls the master operation for Run or the corresponding bit on the configuration word of the master software. If further information is needed, refer to the documentation of the master used.
F237 DeviceNet Connection Timeout	Fault that indicates that one or more DeviceNet connections timed out.	<ul style="list-style-type: none"> ■ Check the network master status. ■ Check network installation, broken cable or fault/poor contact on the connections with the network.
F238 Profibus DP Interface in Clear Mode	It indicates that the inverter received a command from the Profibus DP network master to enter the clear mode.	<ul style="list-style-type: none"> ■ Verify the network master status, making sure it is in the execution mode (Run).
F239 Offline Profibus DP Interface	It indicates an interruption in the communication between the Profibus DP network master and the inverter. The Profibus DP communication interface went into offline status.	<ul style="list-style-type: none"> ■ Check if the network master is correctly configured and operating properly. ■ Check for short-circuit or poor contact on the communication cables. ■ Check if the cables are not misconnected or inverted. ■ Check if the termination resistors with the right value were installed only at the end of the main bus. ■ Check the network installation in general - cabling, grounding.
F240 Profibus DP Module Access Fault	It indicates fault in the access to the Profibus DP communication module data.	<ul style="list-style-type: none"> ■ Check if the Profibus DP module is correctly fitted. ■ Hardware errors due to improper handling or installation of the accessory, for instance, may cause this fault. If possible, carry out tests by replacing the communication accessory.
F247 EtherNet/IP Communication Offline	It indicates interruption in the cyclic communication with EtherNet/IP master. It occurs when, for any reason, after the cyclic communication of the master with the product is started, this communication is interrupted.	<ul style="list-style-type: none"> ■ Check the status of the network master. ■ Check the network installation, broken cable or failed/bad contact in the network connections.
F249 Timeout Modbus TCP	It indicates that the device stopped receiving valid telegrams for a period longer than the setting in P868. The time counting starts as soon as it receives the first valid telegram.	<ul style="list-style-type: none"> ■ Check network installation, broken cable or fault/poor contact on the connections with the network, grounding. ■ Ensure the Modbus TCP client always sends telegrams to the equipment in a time shorter than the setting in P868. ■ Disable this function in P868.
A700 Remote HMI Communication	No communication with remote HMI, but there is no frequency command or reference for this source.	<ul style="list-style-type: none"> ■ Check if the communication interface with the HMI is properly configured in parameter P312. ■ HMI cable disconnected.
F701 Remote HMI Communication Fault	No communication with the remote HMI; however, there is command or frequency reference for this source.	<ul style="list-style-type: none"> ■ Check that the HMI communication interface is properly configured in parameter P312. ■ HMI cable disconnected.
A702 Inverter Disabled	This failure occurs when there is a SoftPLC movement block active and the "General Enable" command is disabled.	<ul style="list-style-type: none"> ■ Check if the drive General Enable command is active.

QUICK REFERENCE OF ALARMS AND FAULTS

Fault / Alarm	Description	Possible Causes
A704 Two Movem. Enabled	It occurs when 2 or more SoftPLC movement blocks are enabled at the same time.	<ul style="list-style-type: none"> ■ Check the user's program logic.
A706 Refer. Not Progr. SPLC	This failure occurs when a SoftPLC movement block is enabled and the speed reference is not programmed for the SoftPLC.	<ul style="list-style-type: none"> ■ Check the programming of the references in the Local and/or Remote mode (P221 and P222).
A708 SoftPLC Application Stopped	SoftPLC Application not running.	<ul style="list-style-type: none"> ■ SoftPLC Application is stopped (P901 = 0 and P900 = 3). ■ SoftPLC state presents application incompatible with the firmware version of the frequency inverter.
F709 SPLC Application Stopped	SoftPLC application not running.	<ul style="list-style-type: none"> ■ SoftPLC application stopped (P901 = 0 and P900 = 3). ■ SoftPLC state presents incompatible application with the firmware version of the frequency inverter.
F710 Size of the SoftPLC Application	The size of the SoftPLC user's program exceeded the maximum memory capacity.	<ul style="list-style-type: none"> ■ The logic implemented on the SoftPLC is too large. Check project size.
F711 Fault on SoftPLC Application	Fault found in SoftPLC user's program.	<ul style="list-style-type: none"> ■ SoftPLC user's program stored on flash memory is corrupted. ■ Timeout during execution of SoftPLC scan cycle.
A712 SPLC Protected Against Copy	It occurs when there is an attempt to copy the SoftPLC application protected against copies.	<ul style="list-style-type: none"> ■ Attempt to copy SoftPLC application protected against copies ("never permit copies"). ■ Attempt to copy SoftPLC from a copy protected against copies ("no permission to copy from a copy").
F750/A750 to F799/A799 User's Faults/Alarms for SoftPLC	Fault/Alarm range intended for the user's application developed in the SoftPLC function.	<ul style="list-style-type: none"> ■ Defined by the user's application developed in the SoftPLC function.

Faults and Alarms for PID Controller Application (P903 = 1)

Fault / Alarm	Description	Possible Causes
A750 Sleep Mode Active	It indicates that the PID Controller is in the sleep mode.	<ul style="list-style-type: none"> ■ The motor speed remained below the value programmed in P938 for the time programmed in P939.
A760 Low Level of the Control Process Variable	It indicates that the level of the control process variable (P916) is low.	<ul style="list-style-type: none"> ■ The control process variable (P916) remained below the value programmed in P924 for 150 ms.
F761 Low Level of the Control Process Variable	It indicates the motor was switched off due to the low level of the control process variable.	<ul style="list-style-type: none"> ■ The control process variable (P916) remained below the value programmed in P924 for a certain time (P925).
A762 High Level of the Control Process Variable	It indicates that the level of the control process variable (P916) is high.	<ul style="list-style-type: none"> ■ The control process variable (P916) remained above the value programmed in P926 for 150 ms.
F763 High Level of the Control Process Variable	It indicates the motor was switched off due to the high level of the control process variable.	<ul style="list-style-type: none"> ■ The control process variable (P916) remained above the value programmed in P926 for a certain time (P927).
A790 Speed reference source not programmed for the SoftPLC	It indicates that parameters of the speed reference sources in local mode (P221) and in remote mode (P222) were not programmed for the SoftPLC.	<ul style="list-style-type: none"> ■ The PID Controller was enabled, the Run/Stop command is active, and neither of the two parameters of the speed reference source was programmed in 12 (SoftPLC).

Fault and alarm operation:

- Faults operate by indicating their occurrence on the HMI, in the frequency inverter status word (P006), in the present fault parameter (P049) and disabling the motor. They can only be reset with a reset command or de-energizing the frequency inverter.
- Alarms operate by indicating their occurrence on the HMI and in the present alarm parameter (P048). They are automatically reset when the alarm condition ceases existing.

2 SAFETY NOTICES

This manual contains the information necessary for the correct frequency inverter programming.

It was developed to be used by people with proper technical training or qualification to operate this kind of equipment. These people must follow the safety instructions defined by local standards. The noncompliance with the safety instructions may result in death risk and/or equipment damage.

2.1 SAFETY NOTICES IN THIS MANUAL

The following safety notices are used in this manual:



DANGER!

The procedures recommended in this warning have the purpose of protecting the user against death, serious injuries and considerable material damage.



ATTENTION!

The procedures recommended in this warning have the purpose of avoiding material damage.



NOTE!

The information mentioned in this warning is important for the proper understanding and good operation of the product.

2.2 SAFETY NOTICES ON THE PRODUCT

The following symbols are attached to the product, serving as safety notices:



High voltages are present.



Components sensitive to electrostatic discharge. Do not touch them.



Mandatory connection to the protective earth (PE).



Connection of the shield to the ground.

2.3 PRELIMINARY RECOMMENDATIONS



DANGER!

Only qualified personnel familiar with the frequency inverter and associated equipment should plan or implement the installation, start-up and subsequent maintenance of this equipment.

These personnel must follow all the safety instructions included in this manual and/or defined by local regulations.

Failure to comply with these instructions may result in life threatening and/or equipment damage.

SAFETY NOTICES



NOTE!

For the purposes of this manual, qualified personnel are those trained to be able to:

1. Install, ground, energize and operate the frequency inverter according to this manual and the effective legal safety procedures.
2. Use protective equipment according to the established standards.
3. Give first aid services.



DANGER!

Always disconnect the input power before touching any electrical component associated to the frequency inverter.

Many components may remain loaded with high voltages and/or moving (fans), even after the AC power supply input is disconnected or turned off.

Wait for at least ten minutes in order to guarantee the full discharge of the capacitors. Always connect the frame size of the equipment to the protective earth (PE) at the proper point for that.



ATTENTION!

Electronic boards have components sensitive to electrostatic discharge. Do not touch directly the component parts or connectors.

If necessary, first touch the grounded metallic frame size or use proper grounding strap.

Do not execute any applied potential test on the inverter! If it is necessary, consult the manufacturer.



NOTE!

- Frequency inverters may interfere in other electronic equipments. Observe the recommendations of chapter 3 Installation and Connection of the user's manual in order to minimize these effects.
- Read the user's manual completely before installing or operating this inverter.

3 GENERAL INFORMATION

This manual presents information necessary for the configuration of all the functions and parameters of the frequency inverter. This manual must be used together with the user's manual.

The text provides additional information so as to simplify the use and programming of the frequency inverter in certain applications.

It is prohibited the reproduction of the contents of this manual, in whole or in part, without the written permission of the manufacturer.

3.1 TERMINOLOGY AND DEFINITIONS

3.1.1 Terms and Definitions Used

Amp, A: Ampère.

AIP: analog input via potentiometer.

Aix: analog input "x".

AOx: analog output "x".

° **C:** Celsius degrees.

AC: alternate current.

DC: direct current.

Pre-Charge Circuit: charges the capacitors of the DC link with limited current, avoiding current peaks in the inverter power-up.

CO/DN/PB/ETH: Interface CANopen, DeviceNet, ProfibusDP or Ethernet. Check for the interface availability at product user's manual.

CV: cavalo-vapor = 736 Watts (Brazilian unit of measurement of power, normally used to indicate mechanical power of electric motors).

Heatsink: metal part designed to dissipate the heat produced by power semiconductors.

Dix: digital input "x".

DOx: digital output "x".

Switching Frequency: switching frequency of the IGBTs of the inverter bridge, normally expressed in kHz.

Run/Stop: inverter function which, when activated (run), accelerates the motor by acceleration ramp up to the reference frequency and, when deactivated (stop), decelerates the motor by deceleration ramp. It may be controlled by digital input set for this function, via serial or via SoftPLC.

h: hour; time unit.

General Enable: when activated, it accelerates the motor by acceleration ramp and Run/Stop = Run. When disabled, the PWM pulses will be immediately blocked. It may be controlled by digital input set for this function, via serial or via SoftPLC.

HMI: human-machine interface; device which allows controlling the motor, viewing and changing the inverter parameters. It features keys to control the motor, navigation keys and graphic LCD display.

hp: horse power = 746 Watts (power unit, normally used to indicate mechanical power of electric motors).

Hz: hertz; frequency unit.

IGBT: insulated gate bipolar transistor - basic component part of the output inverter bridge. It works as an electronic switch in the saturated (closed switch) and cut-off (open switch) modes.

GENERAL INFORMATION

I_{nom}: inverter rated current by P295.

kHz: kilohertz = 1000 Hertz; frequency unit.

DC Link: intermediary circuit of the inverter; voltage in direct current obtained by rectifying the power supply alternate voltage or external supply; it supplies the output inverter bridge with IGBTs.

mA: milliampère = 0.001 Ampère.

min: minute; time unit.

ms: milisecond = 0.001 second.

Nm: Newton meter; torque unit.

NTC: resistor whose resistance value in ohms decreases proportionally to the increase of the temperature; it is used as a temperature sensor in power packs.

PE: Protective Earth.

PTC: resistor whose resistance value in ohms increases proportionally to the temperature; it is used as a temperature sensor in motors.

PWM: pulse width modulation - modulation by pulse width; pulsed voltage that supplies the motor.

Rectifier: input circuit of the inverters that transforms the input AC voltage into DC. It is formed by high-power diodes.

RMS: root mean square; effective value.

rpm: revolutions per minute; rotation unit.

s: second; time unit.

V: volts; electric voltage unit.

WPS: Programming Software “WEG Programming Suite”.

Ω: ohms; electric resistance unit.

3.1.2 Numerical Representation

Throughout the manual, parameter values with suffix “hexa” represent hexadecimal numbers. The decimal numbers are represented by means of digits without suffix.

3.1.3 Symbols to Describe Parameter Properties

ro: read only parameter.

cfg: parameter that can be changed only with a stopped motor.

V/f: parameter available in the V/f mode.

VVW: parameter available in the VVW mode.

4 ABOUT THE HMI

4.1 USE OF THE HMI TO OPERATE THE INVERTER

Using the HMI, it is possible to command the inverter, view and adjust all of its parameters. The HMI presents the following functions:

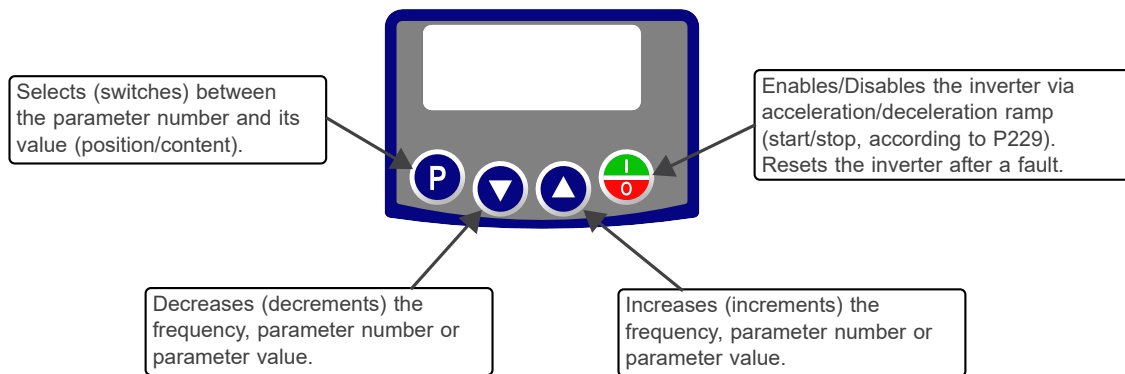

Figure 4.1: HMI keys

4.2 INDICATIONS ON THE HMI DISPLAY

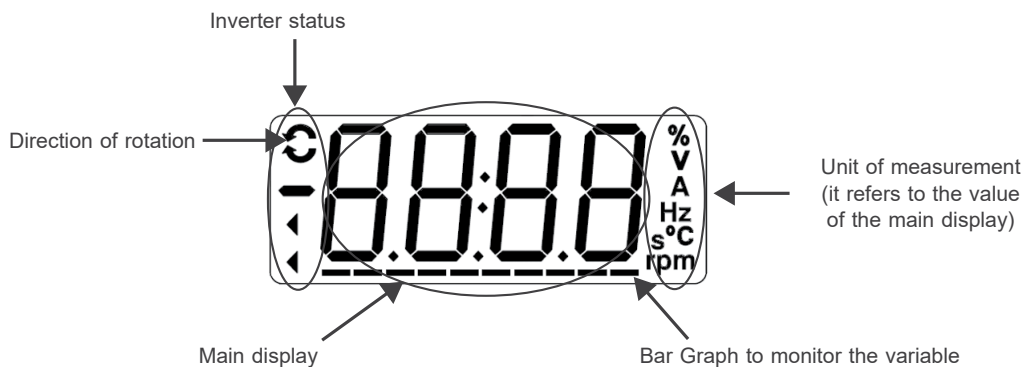

Figure 4.2: Display areas

4.3 OPERATING MODES OF THE HMI

When inverter is powered-up, the initial state of the HMI remains in the start-up mode as long as no faults, alarms, undervoltages occur or no keys are pressed.

The setting mode is composed of two levels: Level 1 allows browsing the parameters. Level 2 allows the modification of the parameter selected in level 1. At the end of this level, the modified value is saved when the **P** key is pressed.

A [Figure 4.2 on page 4-1](#) illustrates the basic browsing of the operating modes of the HMI.



NOTE!

When the inverter is in the fault state, the main display indicates the number of the fault in the format **Fxxx**. The browsing is allowed after pressing the **P** key.

ABOUT THE HMI

Table 4.1: HMI operating modes

Start-up Mode		<pre> graph TD Monitoring[Monitoring] -- P --> S1[Setting level 1] S1 -- P --> S2[Setting level 2] S2 -- A --> LP[Locked Parameter] LP -- V --> S2 LP -- A --> S1 </pre>
<ul style="list-style-type: none"> It is the initial status of the HMI after the successful power-up (without fault, alarms or undervoltages). Press the P key to go to level 1 of the setting mode - parameter selection. Pressing any other key will also change to the setting mode. 		
<p>Setting Mode</p> <p>Level 1:</p> <ul style="list-style-type: none"> This is the first level of the setting mode. The number of the parameter is shown on the main display. Use the A and V keys to find the desired parameter. Press the P key to go to level 2 of the setting mode - modification of the parameter content. 		
<p>Level 2:</p> <ul style="list-style-type: none"> The content of the parameter is shown on the main display. Use the A and V keys to configure the new value for the selected parameter. Press the P key to confirm the modification (save the new value). After the change is confirmed, the HMI returns to level 1 of the setting mode. 		
<p>Locked Parametrization</p> <p>This state is displayed when the A or V keys are pressed while viewing the parameter value with the following characteristics:</p> <ul style="list-style-type: none"> The displayed parameter is read-only. The parameter has CFG property (change only with stopped motor) and the motor is running. The inverter has a defined password (except if it is a SoftPLC user parameter and has the unprotected property checked). <p>The parameter value is automatically displayed again when the keys are released.</p>		



NOTE!

When the inverter is in the alarm state, the main display indicates the number of the alarm in the format **Axxx**. The browsing is allowed after pressing the **P** key, and then the indication “**A**” is displayed on the unit of measurement display, flashing until the situation causing the alarm is solved.

5 HMI



NOTE!

The inverter comes from the factory with the frequency (V/f 50/60 Hz mode) and voltage adjusted according to the market.

The reset to factory default may change the content of the parameters related to frequency. In the detailed description, some parameters have values between brackets, which represents the default value for operation in 50 Hz; thus the value without brackets is the default for operation in 60 Hz.

5.1 ACCESS

Whenever the inverter is powered up, the HMI display goes to the start-up mode if no faults, alarms or undervoltages are present. In order to simplify the reading of the inverter parameters, the display was designed to show two parameters simultaneously, at the user's discretion. One of those parameters (main display) is shown in the numeric form and the other parameter as a bar graph. The parameter monitored by the bar graph is selected via P207, as indicated in [Figure 5.1 on page 5-1](#).

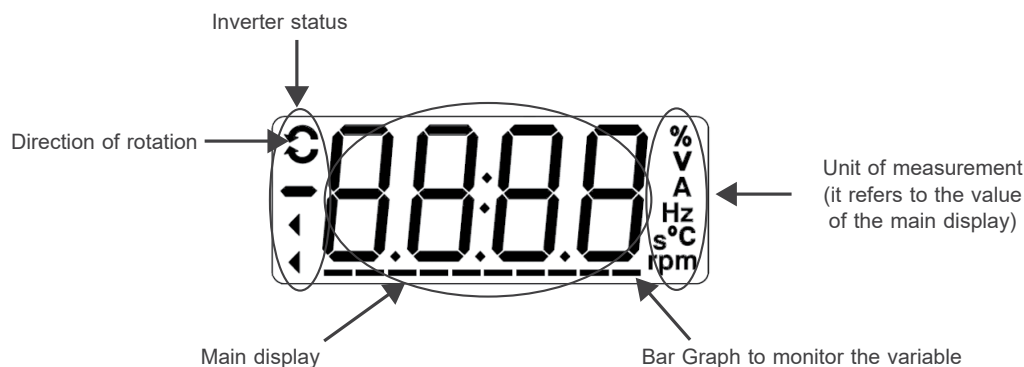

Figure 5.1: Screen on initialization and display fields

P000 - Access to Parameters

Adjustable Range: 0 to 9999

Factory Setting: 1

Description:

Password input to release the access to the parameters. Once a password is saved in P200, the access to the parameters is only allowed if this password is set in P000. After setting P000 with a password value, P000 will show "1" or "0", keeping the set password value hidden. Where "1" releases the access to parameters and "0" locks the access to the parameters.



NOTE!

The view of parameter P000 on the HMI will only be available when the password is active (P200 = 1).

To release the access to the parameters, it is necessary to set P000 after each inverter energization, as such information is not retained.

P200 - Password

Adjustable Range:	0 = Inactive 1 = Active 2 to 9999 = New Password	Factory Setting:	0
Properties:	cfg		

Description:

It allows activating the password (by inserting a new value) or disabling it. For further details regarding the use of this parameter, refer to [Table 5.1 on page 5-2](#).

Table 5.1: Required procedure for each kind of action

Action	Procedure
Activate password	1. Set P200 with the desired value for the password (P200 = password) 2. The setting is completed, the new password is active and P200 is automatically adjusted for 1 (password active) ⁽¹⁾
Change password	1. Set the current value of the password (P000 = password). P000 is automatically adjusted for 1 2. Set the desired value for the new password in P200 (P200 = new password) 3. The setting is completed, the new password is active and P200 is automatically adjusted for 1 (password active) ⁽¹⁾
Disable password	1. Set the current value of the password (P000 = password) 2. Set inactive password (P200 = 0) 3. The setting is completed, the password is disabled ⁽²⁾
Disable password	1. Activate a factory default by means of P204 2. The setting is completed, the password is disabled ⁽²⁾

⁽¹⁾ It only allows changing the content of the parameters when P000 is equal to the value of the password.

⁽²⁾ It is allowed to change the content of the parameters and P000 is inaccessible.

P204 - Load/Save Parameters

Adjustable Range:	0 to 4 = Not Used 5 = Load 60 Hz 6 = Load 50 Hz 7 = Load User 1 8 = Load User 2 9 = Save User 1 10 = Save User 2 11 = Load Default SoftPLC 12 to 13 = Reserved	Factory Setting:	0
Properties:	cfg		

Description:

Save or load parameters on the inverter. The [Table 5.2 on page 5-2](#) describes the actions performed by each option.

Table 5.2: Option of parameter P204

P204	Action
0 to 4	Not Used: no action
5	Load WEG 60 Hz: it loads the default parameters on the inverter with the factory default for 60 Hz
6	Load WEG 50 Hz: it loads the default parameters on the inverter with the factory default for 50 Hz
7	Load User 1: it transfers the content of the memory from "User 1" parameter to the inverter current parameters
8	Load User 2: it transfers the content of the memory from "User 2" parameter to the inverter current parameters
9	Save User 1: transfers the current content of the parameters to "User's 1" parameter memory
10	Save User 2: transfers the current content of the parameters to "User's 2" parameter memory
11	Load Default SoftPLC: it loads the factory default in SoftPLC parameters (P910 to P979)
12 and 13	Reserved

In order to load the parameters of users for operating area of the inverter (P204 = 7 or 8) it is necessary that this area be previously saved.

The operation of uploading memory (P204 = 7 or 8), can also be done via digital inputs (DIx). For further details referring to this programming, refer to [Section 9.6 DIGITAL INPUTS on page 9-12](#).

**NOTE!**

When P204 = 5 or 6, parameters P295 (Inv. Rated Current), P296 (Line Rated Voltage) and P308 (Serial Address) are not changed.

**NOTE!**

In order to upload the users parameters (P204 = 7 or 8), the factory default must be uploaded first (P204 = 5 or 6).

5.2 INDICATIONS

This section presents parameters related to the presentation of information on the HMI display. See the detailed description below on the possible settings of these parameters.

P205 - Main Display Parameter

Adjustable Range: 0 to 999

Factory Setting: 2

Description:

It defines which parameter will be viewed on the HMI when the motor is enabled after initialization.

P207 - Bar Graph Parameter

Adjustable Range: 0 to 999

Factory Setting: 3

Description:

Defines which parameter will be shown on the HMI bar graph.

P208 - Ref. Scale Factor

Adjustable Range: 1 to 9999

Factory Setting: 600 (500)

Description:

It allows adjusting the scale of the parameter speed reference P001 and output (motor) speed P002 so as to convert the indication of frequency values applied to the motor (Hz) into angular speed in “rpm” or a proportional value in “%”, for instance.

Together with the unit in P209 and the decimal places in P210, the rated reference P208 defines the speed indication on the inverter HMI. According to the factory default of those parameters, the preset scale on the inverter is in “Hz” and with a decimal place (60.0 Hz or 50.0 Hz). On the other hand, by setting P208 = 1800 or 1500, P209 = 7 and P210 = 0, a scale in “rpm” with no decimal places is defined (1800 rpm or 1500 rpm).

P209 - Ref. Eng. Unit

P510 - SoftPLC Eng. Unit

Adjustable	0 to 1 = Without unit	Factory	P209 = 3
Range:	2 = Volt (V)	Setting:	P510 = 0
	3 = Hertz (Hz)		
	4 = Without unit		
	5 = Percent (%)		
	6 = Without unit		
	7 = Rotation/min. (rpm)		

Description:

It defines the engineering unit that will be displayed on the HMI. P209 is linked to parameters P001 and P002. P510 is linked to the SoftPLC user's parameters. That is, any SoftPLC user's parameter linked to the SoftPLC engineering unit will be displayed in this format.

P210 - Ref. Decimal Point

P511 - SoftPLC Indication Form

Adjustable	0 = wxyz	Factory	P210 = 1
Range:	1 = wxy.z	Setting:	P511 = 1
	2 = wx.yz		
	3 = w.xyz		

Description:

It allows setting the position of the decimal point displayed on the HMI. P210 is linked to the indication of parameters P001 and P002. P511 is linked to the indication of the SoftPLC user's parameters. That is, any SoftPLC user's parameter linked to the SoftPLC indication form will be displayed in this format.

P213 - Bar Scale Factor

Adjustable	1 to 9999	Factory	$1.0 \times I_{nom}$
Range:		Setting:	

Description:

It configures the full scale (100 %) of the bar graph to indicate the parameter selected by P207.

P842 - Quick View 1 IR

P843 - Quick View 2 IR

Adjustable	0 to 959	Factory	2
Range:		Setting:	

Description:

It defines which parameters (their respective values) will be viewed by using the key  key of the infrared remote control (available with expansion module).

For further details, refer to the installation, configuration and operation guide of the expansion module.

6 FREQUENCY INVERTER IDENTIFICATION

In order to check the inverter model, see the code on the product nameplate on the side of the inverter.

Once verified the identification code of the model of the inverter, refer to Chapter 2 General Information of the user’s manual of the frequency inverter.

The parameters related to the inverter model are shown below. They are modified according to the model and version of the inverter and must comply with the data read on the product nameplate.

6.1 INVERTER MODEL

The following are parameters related to inverter information and characteristics, such as inverter model, software version, switching frequency, etc.

P023 - Main SW Version

Adjustable Range:	0.00 to 99.99	Factory Setting:
Properties:	ro	

Description:

It indicates the software version of the main microprocessor on the control board.

FREQUENCY INVERTER IDENTIFICATION

P029 - Power HW Configuration

Adjustable Range:	0 = Not identified 1 = 1.6 A/110 Vac 2 = 2.6 A/110 Vac 3 = 4.2 A/110 Vac 4 = 6.0 A/110 Vac 25 = 1.6 A/220 Vac 26 = 2.6 A/220 Vac 27 = 4.2 A/220 Vac 28 = 6.0 A/220 Vac 29 = 7.3 A/220 Vac 30 = 10.0 A/220 Vac 31 = 15.2 A/220 Vac 49 = 1,6 A/ 310 Vdc 50 = 2,6 A/ 310 Vdc 51 = 4,2 A/ 310 Vdc 52 = 6,0 A/ 310 Vdc 53 = 7,3 A/ 310 Vdc 85 = 1.1 A/380 V NB 86 = 1.8 A/380 V NB 87 = 2.6 A/380 V NB 88 = 3.5 A/380 V NB 89 = 4.8 A/380 V NB 90 = 6.5 A/380 V NB 91 = 8.2 A/380 V NB 92 = 10.0 A/380 V NB 93 = 12.0 A/380 V NB 94 = 15.0 A/380 V NB 109 = 1.1 A/380 V DB 110 = 1.8 A/380 V DB 111 = 2.6 A/380 V DB 112 = 3.5 A/380 V DB 113 = 4.8 A/380 V DB 114 = 6.5 A/380 V DB 115 = 8.2 A/380 V DB 116 = 10.0 A/380 V DB 117 = 12.0 A/380 V DB 118 = 15.0 A/380 V DB	Factory Setting: According to the Inverter Model
Properties:	ro	

Description:

It indicates the inverter model, distinguishing the supply voltage and the rated current according to [Table 6.1 on page 6-3](#).

From P029, the inverter determines the current and voltage parameters depending on the model identification. On the other hand, this action is only effected at the moment of the factory standard load (P204 = 5 or 6).

FREQUENCY INVERTER IDENTIFICATION

Table 6.1: Identification of the inverter models

Frame size	Voltage	Feature	Current	P029
A	110 / 127 Vac	Single-Phase	1.6 A	1
			2.6 A	2
			4.2 A	3
			6.0 A	4
	200 / 240 Vac	Single or Three-Phase	1.6 A	25
			2.6 A	26
			4.2 A	27
			6.0 A	28
			7.3 A	29
	310 Vdc	DC Link	1.6 A	49
			2.6 A	50
			4.2 A	51
6.0 A			52	
B	200 / 240 Vac	Single, Three-Phase or DC Link	7.3 A	53
		Three-Phase or DC Link	10.0 A	30
			15.2 A	31
A	380 / 480 Vac	Three-Phase NB	1.1 A	85
			1.8 A	86
			2.6 A	87
			3.5 A	88
			4.8 A	89
B	380 / 480 Vac or 513 to 650 Vdc	Three-Phase DB	1.1 A	109
			1.8 A	110
			2.6 A	111
			3.5 A	112
			4.8 A	113
		Three-Phase NB	6.5 A (*) / 5.6 A (**)	90
			8.2 A (*) / 7.6 A (**)	91
		Three-Phase DB	6.5 A (*) / 5.6 A (**)	114
			8.2 A (*) / 7.6 A (**)	115
		C	380 / 480 Vac or 513 to 650 Vdc	Three-Phase NB
12.0 A (*) / 11.0 A (**)	93			
15.0 A (*) / 14.0 A (**)	94			
Three-Phase DB	10.0 A (*) / 8.3 A (**)			116
	12.0 A (*) / 11.0 A (**)			117
	15.0 A (*) / 14.0 A (**)			118

(*) Rated current for power supplies of 380-400-415 Vac.

(**) Rated current for power supplies of 440-460-480 Vac.



NOTE!

The models of the 400 V line have rated currents specified according to the supply voltage:

- **Voltage range 1:** power supplies of 380-400-415 Vac, or 513-540-560 Vdc (P296 = 4 or 5).
- **Voltage range 2:** power supplies of 440-460-480 Vac, or 594-621-650 Vdc (P296 = 6 or 7).

For these models, P296 must be adjusted in accordance with the mains voltage used, and the parameter P295 will be changed automatically by the inverter. For more information, refer to the user manual, available for download on www.weg.net.

P295 - Inverter Rated Current

Adjustable Range: 1.1 to 100.0 A

Factory Setting: According to the Inverter Model

Properties: ro

Description:

It indicates the inverter rated current according to [Table 6.1 on page 6-3](#).

FREQUENCY INVERTER IDENTIFICATION

P296 - Line Rated Voltage

Adjustable Range:	0 = Reserved 1 = 110 - 127 Vac 2 = 200 - 240 Vac 310 Vdc 3 = Reserved 4 = 380 Vac 513 Vdc 5 = 415 Vac 560 Vdc 6 = 440 Vac 594 Vdc 7 = 480 Vac 650 Vdc	Factory Setting:	According to the Inverter Model
--------------------------	--	-------------------------	---------------------------------

Description:

This parameter shows the inverter supply voltage according to the identification made after power up (and for models of the 400 V Line, after adjustment).



NOTE!

200 V Line: P296 is read-only parameter (ro).

400 V Line: P296 is configuration parameter (cfg).

For further information, refer to the user's manual, available for download on: www.weg.net.

P613 - Main SW Revision

Adjustable Range:	-9999 to 9999	Factory Setting:
Properties:	ro	

Description:

It indicates the main software revision number. It is automatically generated by the machine that compiled the firmware.

6.2 ACCESSORIES

Accessories identified by the inverter control circuit.

P024 - IO Acces. SW Version

P025 - Comm. Acces. SW Version

Adjustable Range:	0.00 to 99.99	Factory Setting:
Properties:	ro	

Description:

It indicates the software versions of the connected accessories microprocessors according to parameters P027 and P028.

P027 - Config. Acces. IO

P028 - Config. Comm. Acces.

Adjustable Range: 0 to 10

Factory Setting:

Properties: ro

Description:

It indicates accessories that are connected according to the quick reference of each product.

Table 6.2: IO's expansion accessories

Name	Description	P027
-	No accessories	0
CFW320-IOAR	Accessory for IO's expansion: 1 analog input + 1 analog output + 3 relay digital outputs	1
CFW320-IODR	Accessory for IO's expansion: 4 digital inputs (NPN/PNP) + 3 relay digital outputs	2
CFW320-IOADR	Accessory for IO's expansion: 1 input for infrared receiver + 1 NTC sensor input + 3 relay digital outputs	3
CFW320-IOAENC	Accessory for IO's expansion: 1 analog input + 2 analog outputs + 1 differential encoder input	4
-	Reservado	5
CFW320-IODF	Accessory for IO expansion: 3 inputs and 3 outputs in frequency	6
-	Reserved	7 a 10

Table 6.3: Communication expansion accessories

Name	Description	P028
-	No accessories	0
CFW320-HMIR	Remote HMI accessory (via CFW320-CRS485 accessory)	1
-	Reserved	2
CFW320-CCAN	Accessory with communication CANopen and DeviceNet	3
CFW320-CPDP	Accessory with communication Profibus DP	4
CFW320-CETH	Accessory with communication Ethernet	5
-	Reserved	6
CFW320-IOP	Accessory for IO expansion: 1 analog input	7
CFW320-CBLT	Bluetooth communication accessory	8
-	Reserved	9 a 10

7 COMMAND AND REFERENCES

The drive of the electric motor connected to the inverter depends on the logical command and on the reference defined by one of the several possible sources, such as: HMI keys, digital inputs (Dix), analog inputs (Aix), Serial/ USB interface, CANopen/DeviceNet interface, SoftPLC, etc.

The command via HMI is limited to a set of functions pre-defined for the keys according to [Chapter 5 HMI on page 5-1](#), similarly to the digital inputs (Dix), with the functions implemented in parameter P263 to P266. On the other hand, the command via digital interfaces, such as communication network and SoftPLC, act directly on the inverter control word by means of control parameters and system markers of the SoftPLC, respectively.

The frequency reference, in turn, is processed inside the frequency inverter in 16 bits with signal (-32768 to +32767) for a range of -400.0 Hz to +400.0 Hz. On the other hand, the unit factor, range and resolution of the reference depend on the used source, as described in [Section 7.2 SPEED REFERENCE on page 7-6](#).

7.1 REFERENCE SOURCE SELECTION

The inverter command and reference source is defined by the inverter parameters for two different situations: Local and Remote, which can be switched dynamically during the inverter operation. Thus, for a certain parameterization, the inverter has two sets for command and reference, according to block diagram of [Figure 7.1 on page 7-2](#). Parameter P220 determines the source of commands for Local and Remote situations.

Parameters P223, P224 and P225 define the commands in the Local situation; parameters P226, P227 and P228 define the commands in the Remote situation, and parameter P105 determines the source for selection between 1st and 2nd Ramp. This structure for the selection of the command source is shown in [Figure 7.1 on page 7-2](#).

Parameters P221 and P222 define the frequency reference in the Local and Remote situations. This structure for the selection of the reference source is shown in [Figure 7.2 on page 7-3](#).

COMMAND AND REFERENCES

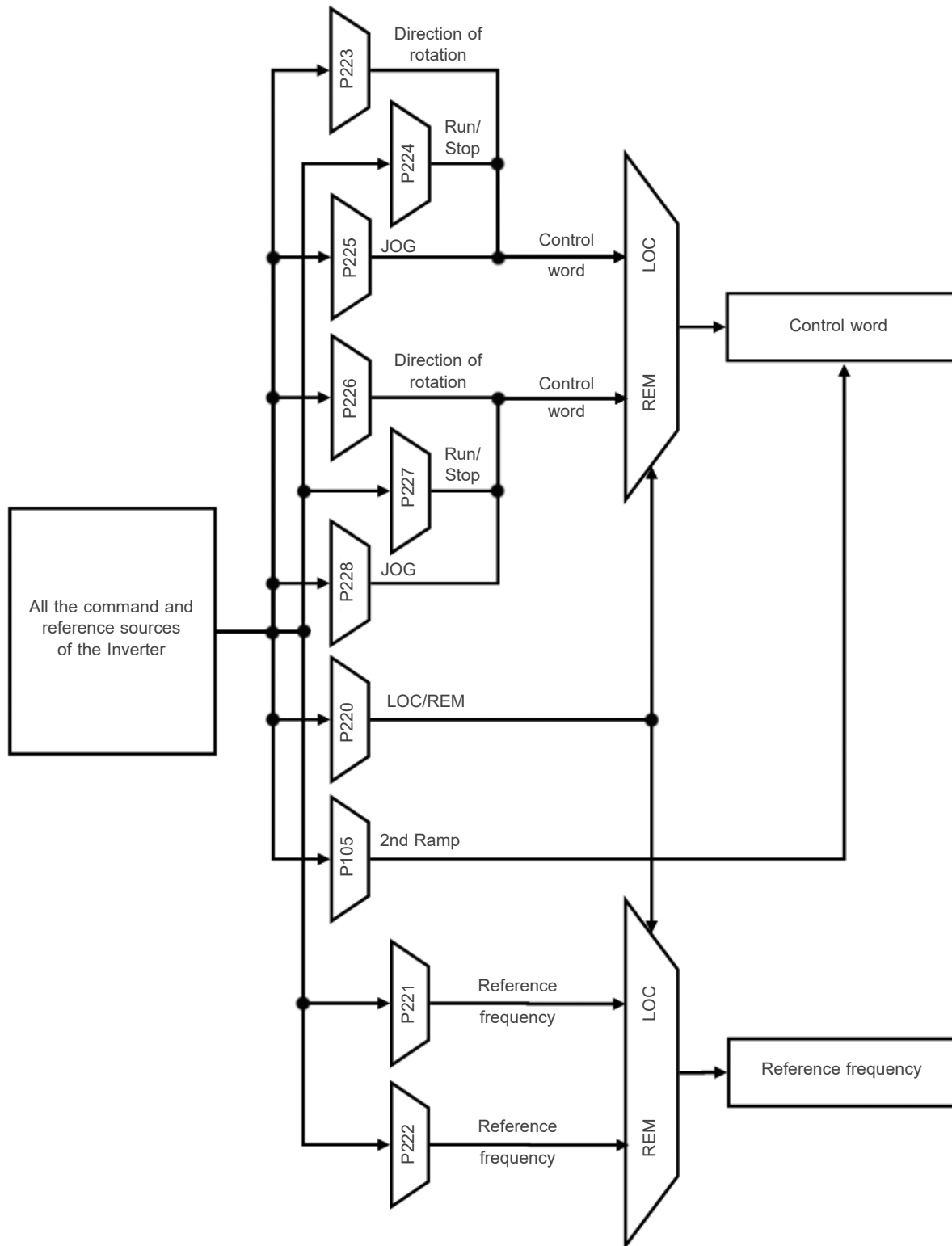

Figure 7.1: Block diagram for commands and references

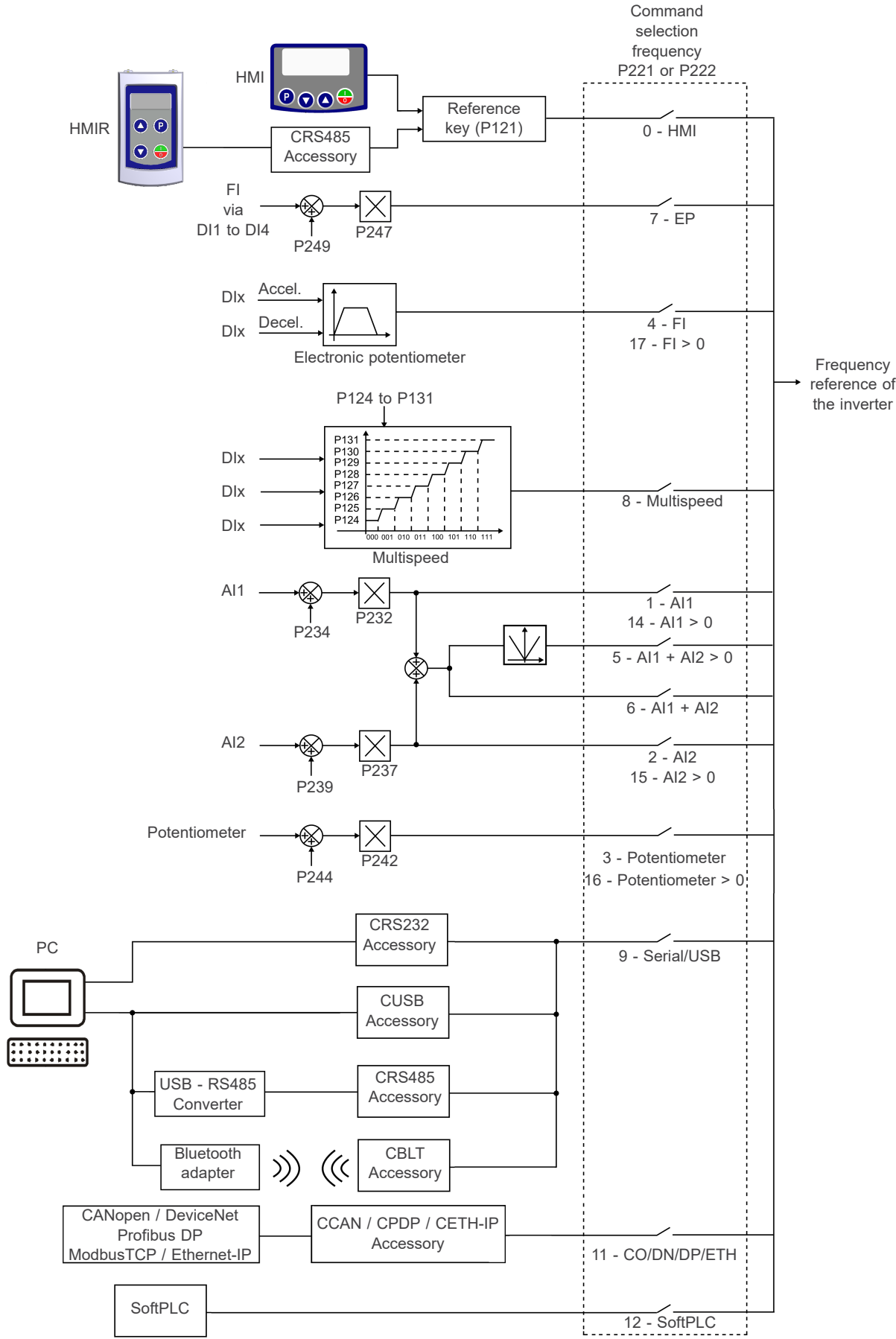

Figure 7.2: Structure to select the frequency reference

COMMAND AND REFERENCES

P220 - LOC/REM Selection Source

Adjustable Range:	0 = Always Local 1 = Always Remote 2 to 3 = Not Used 4 = DIx 5 = Serial/USB (LOC) 6 = Serial/USB (REM) 7 to 8 = Not Used 9 = CO/DN/DP/ETH (LOC) 10 = CO/DN/DP/ETH (REM) 11 = SoftPLC	Factory Setting: 0
Properties:	cfg	

Description:

It defines the command origin source which will select between Local situation and Remote situation, where:

- **LOC:** means Local situation default.
- **REM:** means Remote situation default.
- **DIx:** according to function programmed for digital input in P263 to P266.
- **CO / DN / DP / ETH:** interface CANopen, DeviceNet, Profibus DP or Ethernet.

P221 - LOC Reference Sel.

P222 - REM Reference Selection

Adjustable Range:	0 = HMI 1 = AI1 2 = AI2 3 = Potentiometer 4 = FI 5 = AI1 + AI2 > 0 6 = AI1 + AI2 7 = E.P. 8 = Multispeed 9 = Serial/USB 10 = Not Used 11 = CO/DN/DP/ETH 12 = SoftPLC 13 = Not Used 14 = AI1 > 0 15 = AI2 > 0 16 = Potentiometer > 0 17 = FI > 0	Factory Setting: P221 = 0 P222 = 1
Properties:	cfg	

Description:

It defines the origin source for the frequency reference in the Local situation and Remote situation.

Some comments on the options of this parameter:

- **AIx:** it refers to the analog input signal according to [Section 9.1 ANALOG INPUTS on page 9-1](#).

- **HMI:** the reference value set by the keys and are contained in parameter P121.
- **E.P.:** electronic potentiometer, refer to [Section 9.6 DIGITAL INPUTS on page 9-12](#).
- **Multispeed:** refer to [Section 9.6 DIGITAL INPUTS on page 9-12](#).
- **Alx > 0:** the negative values of the Alx reference are zeroed.
- **CO / DN / DP / ETH:** interface CANopen, DeviceNet, Profibus DP or Ethernet.

P223 - LOC FWD/REV Selection

P226 - REM FWD/REV Selection

Adjustable Range:	0 = Forward 1 = Reverse 2 to 3 = Not Used 4 = Dlx 5 = Serial/USB (FWD) 6 = Serial/USB (REV) 7 to 8 = Not Used 9 = CO/DN/DP/ETH (FWD) 10 = CO/DN/DP/ETH (REV) 11 = Not Used 12 = SoftPLC	Factory Setting:	P223 = 0 P226 = 4
Properties:	cfg		

Description:

It defines the origin source for the “Direction of Rotation” command in the Local and Remote situation, where:

- **H:** means Forward.
- **AH:** means Reverse.
- **Dlx:** refer to [Section 9.6 DIGITAL INPUTS on page 9-12](#).
- **CO / DN / DP / ETH:** interface CANopen, DeviceNet, Profibus DP or Ethernet.

P224 - LOC Run/Stop Sel.

P227 - REM Run/Stop Selection

Adjustable Range:	0 = HMI Keys 1 = Dlx 2 = Serial/USB 3 = Not Used 4 = CO/DN/DP/ETH 5 = SoftPLC	Factory Setting:	P224 = 0 P227 = 1
Properties:	cfg		

Description:

It defines the origin source for the “Run/Stop” command in the Local and Remote situation. This command corresponds to the functions implemented in any of the command sources able to enable the motor movement, that is, General Enable, Ramp Enable, Forward Run, Reverse Run, Start, etc.

COMMAND AND REFERENCES

P225 - LOC JOG Selection

P228 - REM JOG Selection

Adjustable	0 = Disabled	Factory	P225 = 1
Range:	1 = Not Used	Setting:	P228 = 2
	2 = DIx		
	3 = Serial/USB		
	4 = Not Used		
	5 = CO/DN/DP/ETH		
	6 = SoftPLC		
Properties:	cfg		

Description:

It defines the origin source for the JOG function in the Local and Remote situation. The JOG function means a Run/Stop command added to the reference defined by P122. Refer to [Section 7.2 SPEED REFERENCE on page 7-6](#).

P229 - Stop Mode Selection

Adjustable	0 = Ramp to Stop	Factory	0
Range:	1 = Coast to Stop	Setting:	
Properties:	cfg		

Description:

Defines the motor stop mode when the inverter receives the “Stop” command. [Table 7.1 on page 7-6](#) describes the options of this parameter.

Table 7.1: Selection of stop mode

P229	Description
0	The inverter will apply the stop ramp programmed in P101 or P103
1	The motor will run free until it stops



NOTE!

When the Coast Stop mode is programmed and the Flying Start function is disabled, only activate the motor if it is stopped.



NOTE!

This parameter is applied to all the inverter command sources, but it was created aiming at allowing the command via HMI to be able to disable the motor by inertia instead of deceleration ramp. In this way, when P229 = 1, Bit 0 of the control word (Ramp Enable) has a function similar to Bit 1 (General Enable). The same way, the digital input functions such as: Run/Stop, Forward/Reverse Run stop the motor by inertia in this condition of P229.

7.2 SPEED REFERENCE

The frequency reference is the value applied to the input of the acceleration ramp module (P001) to control the frequency applied to the inverter output (P002) and consequently the motor shaft speed.

Inside the CPU, the inverter uses signed 16 bit variables to treat the frequency references. Besides, the full scale of the reference, output frequency and related variables are defined in 400.0 Hz. On the other hand, depending on the source, this scale is conveniently modified considering the interface with the user by standardization or

application requirements.

In general, the digital references defined by parameters such as: HMI keys (P121), Multispeed (P124 to P131) and E.P. have a scale from 0.0 to 400.0 Hz with resolution of 0.1 Hz.

In digital inputs (DIx), on the other hand, the reference is defined according to the function predefined for P263 to P266.

The frequency reference applied to the inverter output via frequency input follows the behavior of the parameters related to it (P230 to P250).

The full scale of the reference is always by P134, that is, maximum value in AIx is equivalent to the frequency reference equal to P134.

The digital references Serial/USB, CANopen/DeviceNet, Profibus DP, Ethernet and SoftPLC act on a standardized scale called “13-bit speed”, where the value 8192 (2^{13}) is equivalent to the motor rated frequency (P403).

Those references are accessed by parameters P683 and P685.

The digital references, though, have a different scale and the frequency reference parameters with their range from 0.0 to 400.0 Hz, according to previous descriptions, the frequency value on the ramp input (P001) is always limited by P133 and P134.

For example, the JOG reference is given by P122, this parameter may be set in up to 400.0 Hz, but the value applied to the ramp input as reference will be limited by P134 when the function is executed.

Table 7.2: Summary of the scales and resolutions of the frequency references

Reference	Full Scale	Resolution
Analog input (AIx)	-P134 to P134	10 bits or (P134/1024)
Communication Networks and SoftPLC	-400.0 Hz to 400.0 Hz	13-Bit Speed (P403/8192)
HMI Parameter	-400.0 Hz to 400.0 Hz	0.1 Hz

P120 - Speed Ref. Backup

Adjustable	0 = Inactive	Factory	1
Range:	1 = Active	Setting:	
	2 = Backup by P121		

Description:

It defines the operation of the backup function of the speed reference from one of the options Inactive (P120 = 0), Active (P120 = 1) and by P121 (P120 = 2). This function, in turn, determines the form of backup of the digital references of the sources: HMI (P121), E.P. and Serial (P683), according to [Table 7.3 on page 7-7](#).

Table 7.3: Options of parameter P120

P120	Reference Initial Values at the Enabling or Power-Up
0	Value of P133
1	Last adjusted value
2	Value of P121

If P120 = Inactive, the inverter will not save the speed reference value when it is disabled. Thus, when the inverter is enabled again, the speed reference value will become the frequency minimum limit value (P133).

If P120 = Active, the value set in the reference is not lost when the inverter is disabled or powered down.



If P120 = Backup by P121, the reference initial value is fixed by P121 at the enabling or power-up of the inverter.

COMMAND AND REFERENCES

P121 - Reference via HMI

Adjustable Range:	0.0 to 400.0 Hz	Factory Setting:	3.0 Hz
--------------------------	-----------------	-------------------------	--------

Description:

Defines the frequency reference via HMI (P221 = 0 or P222 = 0). When the  and  keys are active and the HMI in the monitoring mode, the value of P121 is increased and shown on the HMI main display. Besides, the P121 is used as input for the reference backup function.



NOTE!

The minimum and maximum values of parameter setting are limited by P134 and P133, respectively.

P122 - JOG Reference

Adjustable Range:	-400.0 to 400.0 Hz	Factory Setting:	5.0 Hz
--------------------------	--------------------	-------------------------	--------

Description:

Defines the frequency to which the motor accelerates following the acceleration ramp set according to P105 during the JOG command. This command may be activated by any of the sources, as per [Section 7.1 REFERENCE SOURCE SELECTION on page 7-1](#). The negative values determine a direction of rotation opposite to that defined by the inverter command word.

P124 - Multispeed Ref. 1

Adjustable Range:	-400.0 to 400.0 Hz	Factory Setting:	3.0 Hz
--------------------------	--------------------	-------------------------	--------

P125 - Multispeed Ref. 2

Adjustable Range:	-400.0 to 400.0 Hz	Factory Setting:	10.0 (5.0) Hz
--------------------------	--------------------	-------------------------	---------------

P126 - Multispeed Ref. 3

Adjustable Range:	-400.0 to 400.0 Hz	Factory Setting:	20.0 (10.0) Hz
--------------------------	--------------------	-------------------------	----------------

P127 - Multispeed Ref. 4

Adjustable Range:	-400.0 to 400.0 Hz	Factory Setting:	30.0 (20.0) Hz
--------------------------	--------------------	-------------------------	----------------

P128 - Multispeed Ref. 5

Adjustable Range:	-400.0 to 400.0 Hz	Factory Setting:	40.0 (30.0) Hz
--------------------------	--------------------	-------------------------	----------------

Table 7.4: Multispeed frequency reference

8 Referency			
4 Referency			
2 Referency			
DI1 or DI2 or DI5 or DI6	DI3 or DI7	DI4 or DI8	Frequency Reference
Inactive	Inactive	Inactive	P124
Inactive	Inactive	Active	P125
Inactive	Active	Inactive	P126
Inactive	Active	Active	P127
Active	Inactive	Inactive	P128
Active	Inactive	Active	P129
Active	Active	Inactive	P130
Active	Active	Active	P131

P129 - Multispeed Ref. 6

Adjustable Range:	-400.0 to 400.0 Hz	Factory Setting:	50.0 (40.0) Hz
--------------------------	--------------------	-------------------------	----------------

P130 - Multispeed Ref. 7

Adjustable Range:	-400.0 to 400.0 Hz	Factory Setting:	60.0 (50.0) Hz
--------------------------	--------------------	-------------------------	----------------

P131 - Multispeed Ref. 8

Adjustable Range:	-400.0 to 400.0 Hz	Factory Setting:	66.0 (55.0) Hz
--------------------------	--------------------	-------------------------	----------------

Description:

It defines the multispeed reference. By the combination of up to three digital inputs, one from eight levels that form the multispeed reference is selected. Read the description of the of the digital inputs in [Section 9.6 DIGITAL INPUTS on page 9-12](#), as well the reference selection in [Section 7.1 REFERENCE SOURCE SELECTION on page 7-1](#). The negative values determine a direction of rotation opposite to that defined by the inverter command word (bit 2 of P682).

[Figure 7.3 on page 7-10](#) and [Table 7.4 on page 7-9](#) show the operation of the Multispeed. Although the most significant digital input may be set at DI1 or DI2, only one of those options is allowed; otherwise, the Config state (ConF), according to [Table 11.3 on page 11-6](#), is activated to indicate parameterization incompatibility.

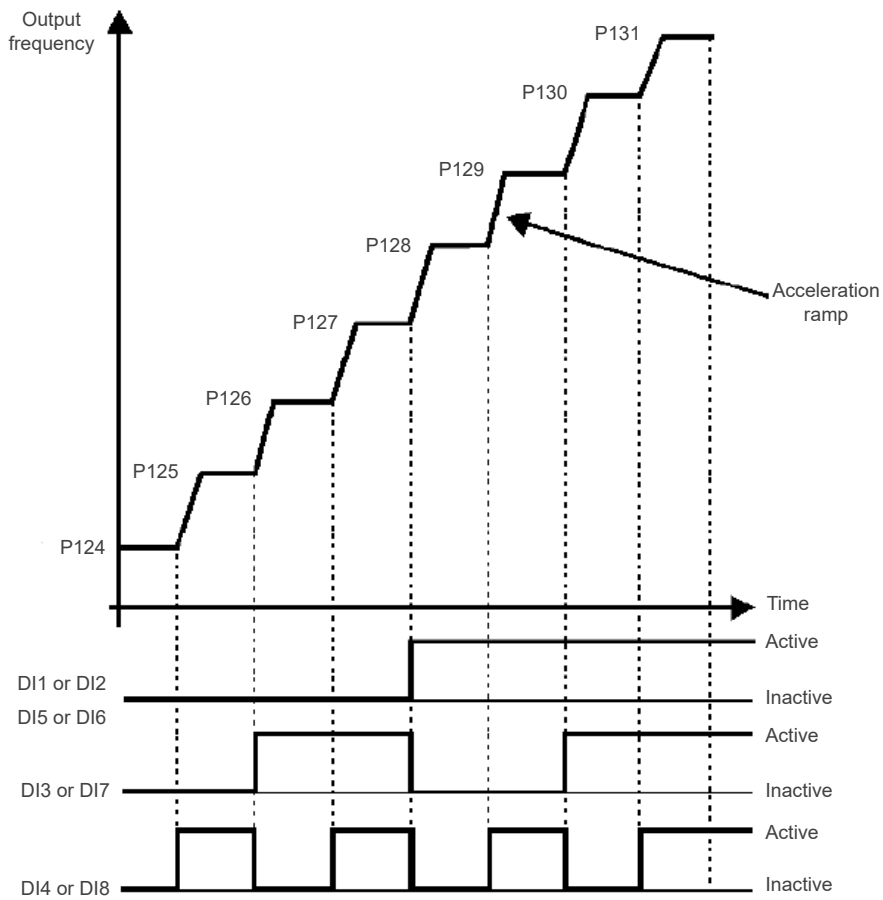

Figure 7.3: Operating graph of the Multispeed function

P133 - Minimum Frequency

Adjustable Range:	0.0 to 400.0 Hz	Factory Setting:	3.0 Hz
--------------------------	-----------------	-------------------------	--------

P134 - Maximum Frequency

Adjustable Range:	0.0 to 400.0 Hz	Factory Setting:	66.0 (55.0) Hz
--------------------------	-----------------	-------------------------	----------------

Description:

It defines limit for frequency reference of the inverter. These limits are applied to any reference source, even in case of "13-bit speed".

8 MOTOR CONTROL

The inverter feeds the motor with variable voltage, current and frequency, providing control of the motor speed. The values applied to the motor follow a control strategy, which depends on the selected type of motor control and on the inverter parameter settings.

The selection of the proper control type for the application depends on the static and dynamic requirements of torque and speed of the driven load, that is, the control type is directly connected to the required performance. Additionally, proper configuration of the selected control mode parameters is essential to reach maximum performance.

The inverter is equipped with three control modes for the three-phase induction motor, that is:

- V/f Scalar Control: for basic applications without output speed control.
- Quadratic V/f Scalar Control: for applications that reduce motor and inverter losses without regulation of the output speed.
- VVW Control: for applications that need high performance in the control of the output speed.

[Section 8.2 V/F on page 8-19](#) and [Section 8.3 VVW on page 8-27](#), each of these kinds of control, related parameters and directions regarding the use of each of these modes are described in details.

P202 - Type of Control

Adjustable Range:	0 = V/f 1 = Quadratic V/f 2 to 4 = Not Used 5 = VVW	Factory Setting:	0
Properties:	cfg		

Description:

It selects the kind of three-phase induction motor control used.

8.1 COMMON FUNCTIONS

This chapter describes the functions common to all inverter control modes V/f and VVW and that interfere in the drive performance.

8.1.1 Ramps

The inverter ramp functions allow the motor to accelerate or decelerate faster or slower. They are adjusted by parameters that define the linear acceleration time between zero and the maximum frequency (P134) and the time for a linear deceleration from the maximum frequency zero.

In the inverter, three ramps with different functions were implemented:

- 1st Ramp - standard for most functions.
- 2nd Ramp - it may be activated by the user, according to the drive requirement, by means of the inverter command word or by a digital input.
- emergency ramp - it is used for the inverter internal protection functions, such as: current limitation, DC link regulation, etc. The Emergency Ramp has priority over the other ramps.



NOTE!

The setting with too short ramp time may cause overcurrent in the output (F070), undervoltage (F021) or overvoltage (F022) of the DC link.

MOTOR CONTROL

P100 - Acceleration Time

P102 - Acceleration Time 2nd Ramp

Adjustable Range:	0.1 to 999.9 s	Factory Setting:	5.0 s
--------------------------	----------------	-------------------------	-------

P101 - Deceleration Time

P103 - Deceleration Time 2nd Ramp

Adjustable Range:	0.1 to 999.9 s	Factory Setting:	10.0 s
--------------------------	----------------	-------------------------	--------

Description:

It defines acceleration and deceleration times according to the active ramp (standard, 2nd ramp or emergency ramp).

P104 - Ramp S

Adjustable Range:	0 = Inactive 1 = Active	Factory Setting:	0
Properties:	cfg		

Description:

It allows the inverter acceleration and deceleration ramps to have a non-linear profile, similar to an “S”, aiming at reducing the mechanical shocks on the load, as shown in [Figure 8.1 on page 8-2](#).

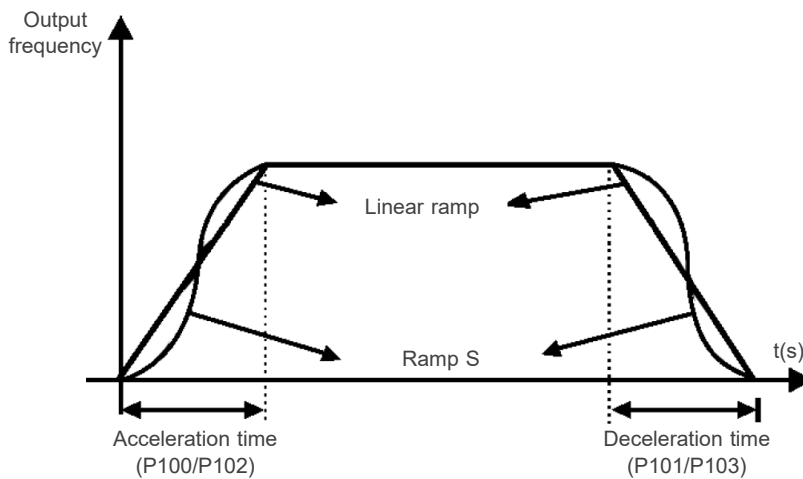

Figure 8.1: S or Linear ramp

P105 - 1st / 2nd Ramp Selection

Adjustable Range:	0 = 1st Ramp 1 = 2nd Ramp 2 = DIx 3 = Serial/USB 4 = Reserved 5 = CO/DN/DP/ETH 6 = SoftPLC	Factory Setting:	0
--------------------------	--	-------------------------	---

Description:

It defines the origin source of the command to select between the first and second Ramp.

Note: Parameter P680 (Logical Status) indicates if the 2nd Ramp is active or not. For further information on this parameter, refer to [Chapter 11 READ on page 11-1](#).

P106 - Emer. R. Acceleration Time

P107 - Emer. R. Time Deceleration

Adjustable Range:	0.1 to 999.9 s	Factory Setting:	5.0 s
--------------------------	----------------	-------------------------	-------

Description:

It defines acceleration and deceleration times according to the active ramp (standard, 2nd ramp or emergency ramp).

8.1.2 Regulation

The DC link voltage and output current limitation are protection functions of the inverter which act on the ramp control, aiming at containing the rise of voltage on the DC link and of the output current. In this way, the following of the reference by the ramp is blocked and the output frequency follows the emergency ramp for a preset safety value.

When the DC link voltage is too high, the inverter may freeze the deceleration ramp. On the other hand, when the output current is too high, the inverter may decelerate or freeze the acceleration ramp in order to reduce this current. Those actions prevent the occurrence of faults F022 and F070, respectively.

Both protections normally occur at different moments of the inverter operation, but in case of occurrence at the same time, by definition, the DC link limitation has higher priority than the output current limitation.

The voltage limitation on the DC link during braking actuates limiting the braking power and torque, so as to prevent the shutting down of the inverter for overvoltage (F022). This situation often occurs when a load with high moment of inertia is decelerated or when short deceleration time is programmed.

P150 - DC/LC Regul. Type

Adjustable Range:	0 = hold_Ud and decel_LC 1 = accel_Ud and decel_LC 2 = hold_Ud and hold_LC 3 = accel_Ud and hold_LC	Factory Setting:	0
Properties:	cfg		

Description:

It configures the behavior of the ramp for the limitation functions of the DC Link Voltage and Current Limitation. In those cases, the ramp ignores the reference and takes an action of accelerating (accel), decelerating (decel)

MOTOR CONTROL

or freezing (hold) the normal path of the ramp. That occurs because of the limit pre-defined in P151 and P135 for the DC Link (Ud) Limitation and for Current (LC) Limitation, respectively.

8.1.2.1 DC Link Voltage

The voltage limitation of the DC Link may work in two ways:

8.1.2.1.1 DC Link Voltage Limitation by “Ramp Hold” (P150 = 0 or 2)

- It has effect during deceleration only.
- Actuation: when the DC link voltage reaches the level set in P151, a command is sent to the “ramp” block, which inhibits the motor frequency variation according to [Figure 8.12 on page 8-20](#) and [Figure 8.20 on page 8-28](#).
- Use recommended in the drive of loads with high moment of inertia referred to the motor shaft or loads that require short deceleration ramps.

8.1.2.1.2 DC Link Voltage Limitation by “Accelerate Ramp” (P150 = 1 or 3)

- It has effect in any situation, regardless the motor frequency condition: accelerating, decelerating or constant frequency.
- Actuation: when the DC link voltage reaches the level set in P151, a command is sent to the ramp block to accelerate the motor.
- Use recommended for the drive of loads that require braking torques at constant frequency in the inverter output. For example, the drive of loads with eccentric shaft as in sucker rod pumps; another application is the handling of loads with balance like in the translation in overhead cranes.

P149 - DC Link Comp. Mode

Adjustable	0 = Inactive	Factory	0
Range:	1 = Standard	Setting:	
	2 = Overmodulation		
	3 = Extended		
Properties:	cfg, V/f		

Description:

It allows selecting modes for compensating the oscillations of the DC Link. The voltage of the capacitor bank (or DC Link) originates from the voltage of the rectified supply line. The value of this voltage varies according to the characteristics of the power line where the inverter is installed and the load requirements of the motor driven by the inverter.

The value of the output voltage (voltage applied to the motor) is directly related to the DC Link voltage through the modulation index. The modulation index is defined as a ratio between the fundamental component amplitude in the inverter phase output voltage and the DC Link voltage.

Thus, variations in the supply line voltage affect the DC Link voltage, which cause variations in the output voltage, as shown in [Figure 8.2 on page 8-5](#), preventing the output voltage from reaching its maximum value.

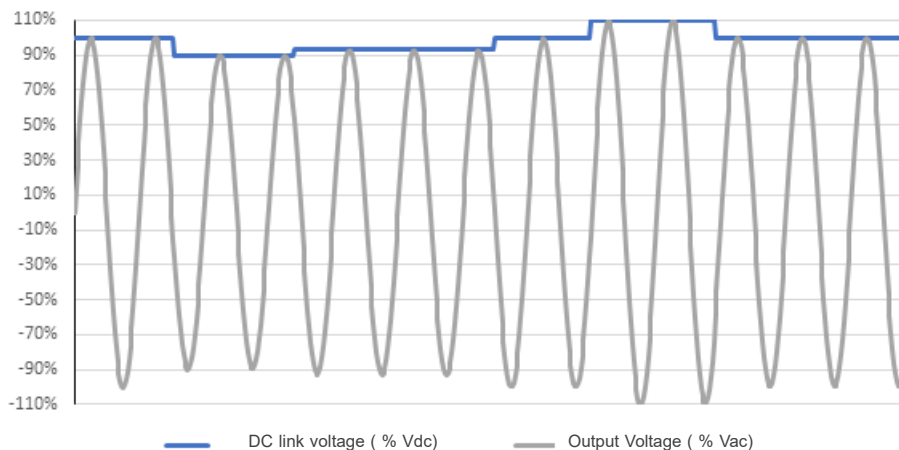

Figure 8.2: Influence of the DC Link in the output voltage

Another condition that prevents the output voltage from reaching its maximum value is internal losses of the inverter. Such losses are associated to the dead time of the switching and losses in the components, being aggravated by the increase of the switching frequency.

Such conditions, variations in the DC Link voltage and internal losses can be compensated with variations in the modulation index; however, with specific characteristics as presented in each of the options below:

- **P149 = 0 (Disabled):** The DC Link compensation is disabled. The DC Link voltage oscillations will be reflected in the output voltage.
- **P149 = 1 (Standard):** In this mode, the output voltage will be generated according to the ideal V/f profile, parameterized in P142, P143, P145 and P146, but not reaching the maximum available voltage at the output and also not generating distortions in the output voltage.
- **P149 = 2 (Overmodulation):** When selecting this option the output voltage will also be generated according to the ideal V/f profile, parameterized in P142, P143, P145 and P146, but the maximum available voltage can be generated. On the other hand, distortions in the output voltage may occur.
- **P149 = 3 (Extended):** This option works similarly to option 2 (overmodulation). However, in the event of a DC Link voltage drop of approximately 20 % of the rated voltage, the function may take two different actions:
 1. If the torque demand is low, it reduces the voltage applied to the motor, also reducing the motor current, allowing to maintain the application, or;
 2. If the torque demand is high, it reduces the output frequency until it is possible to generate a voltage according to the V/f profile.

Both cases have restrictions of use according to the final application, and the user is responsible for validating the application.



NOTE!

It is recommended to use extended DC Link voltage compensation mode (P149 = 3) for quadratic torque applications (blowers, fans, pumps and compressors).



ATTENTION!

The use of the DC Link voltage compensation options does not compensate for all internal losses of the inverter, and it is not intended to increase the performance in installations that do not observe the recommendations in the product user's manual.

MOTOR CONTROL

P151 - DC Link Regul. Level

Adjustable Range: 325 to 810 V

Factory Setting: 430 V (P296=1)
 380 V (P296=2)
 781 V (P296=4)
 781 V (P296=5)
 781 V (P296=6)
 781 V (P296=7)

Description:

It defines voltage level to activate the DC link voltage regulation.

Table 8.1: Actuation Level of the voltage regulation

Input Voltage	Actuation Range	Factory Setting
100 to 127 Vac	391 to 460 Vdc	430 Vdc
200 to 240 Vac	349 to 410 Vdc	380 Vdc
380 Vac	621 to 781 Vdc	781 Vdc
415 Vac	646 to 781 Vdc	781 Vdc
440 Vac	716 to 781 Vdc	781 Vdc
480 Vac	747 to 781 Vdc	781 Vdc

Figure 8.3 on page 8-6 shows the block diagram of the actuation of the limitation. Figure 8.4 on page 8-7 and Figure 8.5 on page 8-7 show the example chart.

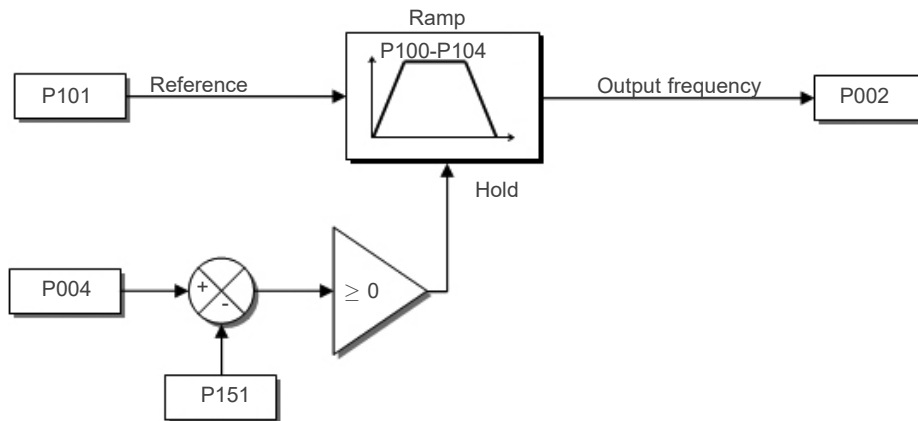

Figure 8.3: Block diagram DC Link voltage limitation

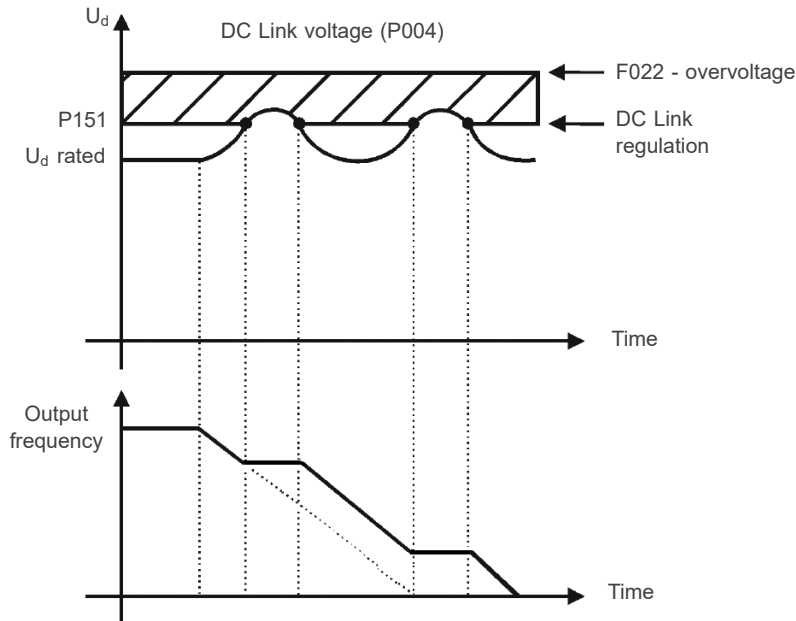

Figure 8.4: Example graph of DC Link voltage limitation - Ramp Hold (P150 = 2 or 3)

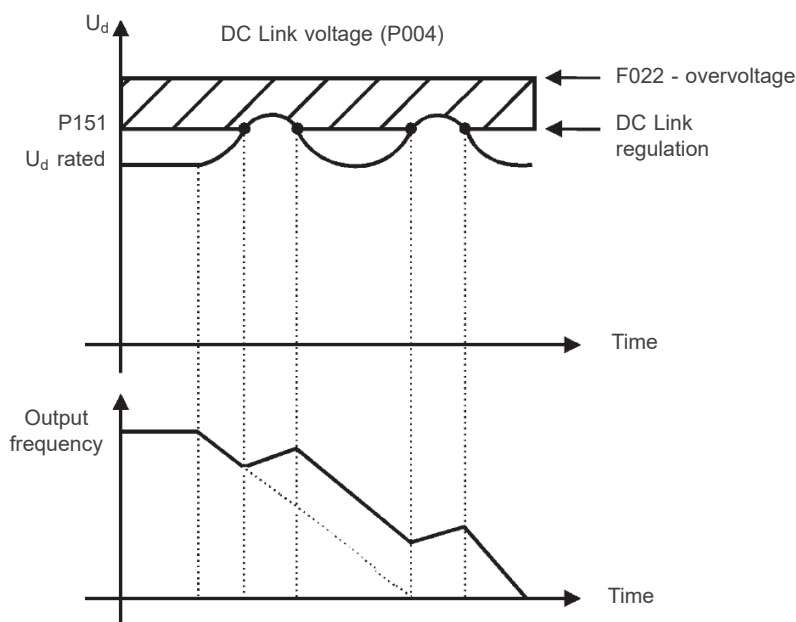

Figure 8.5: Example graph of the DC Link voltage limitation - Accelerate Ramp (P150 = 0 or 1)

8.1.2.2 Output Current

Like in the DC Link voltage regulation, the output current regulation also has two operating modes: “Ramp Holding” (P150 = 2 or 3) and “Decelerate Ramp” (P150 = 0 or 1). Both actuate limiting the torque and power delivered to the motor, so as to prevent the shutting down of the inverter by overcurrent (F070). This situation often occurs when a load with high moment of inertia is accelerated or when short acceleration time is programmed.

8.1.2.2.1 Output Current Limitation by “Ramp Hold” (P150 = 2 or 3)

- It prevents the motor from collapsing during torque overload in the acceleration or deceleration.

MOTOR CONTROL

- Actuation: if the motor current exceeds the value set in P135 during acceleration or deceleration, the frequency will not be incremented (acceleration) or decremented (deceleration). When the motor current reaches a value below P135 the motor accelerates or decelerates again. Refer to [Figure 8.6 on page 8-9](#).
- It has a faster action than the “Decelerate Ramp” mode.
- It acts in the motorization and regeneration modes.

8.1.2.2.2 Current Limitation Type “Decelerate Ramp” (P150 = 0 or 1)

- It prevents the motor from collapsing during torque overload in the acceleration or constant frequency.
- Actuation: if the motor current exceeds the value set in P135, a null value is forced for the frequency ramp input forcing the motor deceleration. When the motor current reaches a value below P135 the motor accelerates again. Refer to [Figure 8.6 on page 8-9](#).

P135 - Maximum Output Current

Adjustable Range:	0.0 to 100.0 A	Factory Setting:	$1.5 \times I_{nom}$
--------------------------	----------------	-------------------------	----------------------

Description:

It defines the current level to activate the current limitation for the Ramp Hold and Decelerate Ramp modes, as per [Figure 8.6 on page 8-9](#) (a) and (b), respectively. In order to disable the current limitation, you must set parameter $P135 > 1.9 \times I_{nom}$.

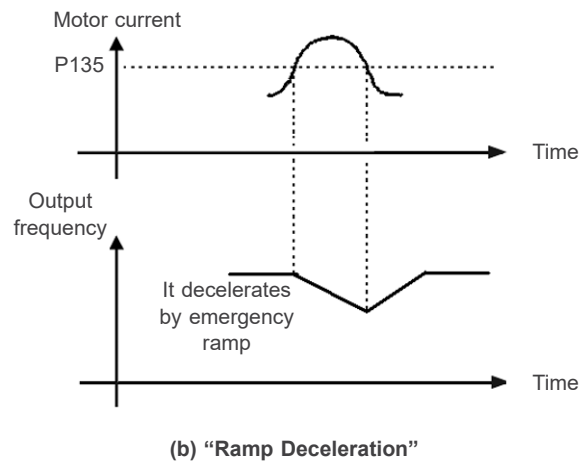
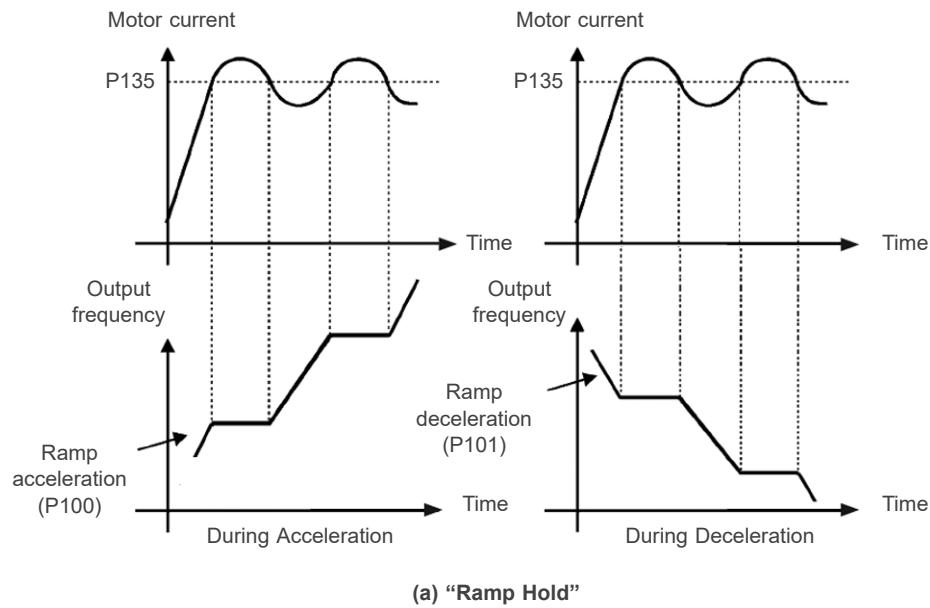

Figure 8.6: (a) and (b) Actuation modes of current limitation via P135

P139 - Output Current Filter

Adjustable Range:	0.000 to 9.999 s	Factory Setting:	0.050 s
--------------------------	------------------	-------------------------	---------

Description:

It defines the time constant of the filter for the total and active output current. You must consider a filter response time equal to three times the time constant set in P139.

8.1.2.3 Switching Frequency

Automatic setting of the switching frequency for an output range.

P219 - Red. Switch. Freq.

Adjustable Range:	0.0 to 15.0 Hz	Factory Setting:	15.0 Hz
Properties:	cfg		

Description:

MOTOR CONTROL

It defines the point at which automatic gradual reduction of the switching frequency occurs. That significantly improves the measurement of the output current at low frequencies and consequently the performance of the inverter.



NOTE!

Both the function related to P219 and the function controlled by P397 (bit 3) act by reducing the switching frequency. As the function related to P219 is intended to improve the reading of the inverter current, that function has priority of action over the function controlled by P397 (bit 3).

P297 - Switching Frequency

Adjustable Range:	2.5 to 15.0 kHz	Factory Setting:	5.0 kHz
Properties:	cfg		

Description:

It defines the inverter IGBT switching frequency.

The inverter switching frequency may be adjusted according to the application needs. Higher switching frequencies imply less acoustic noise in the motor. However, the switching frequency choice results in a compromise among the acoustic noise in the motor, the inverter IGBT losses and the maximum permitted currents.

The reduction of the switching frequency reduces the effects related to the motor instability, which occurs in certain application conditions. Besides, it reduces the earth leakage current, preventing the actuation of the faults F070 (output overcurrent or short-circuit).

8.1.3 Flying Start / Ride-Through

The Flying Start function allows driving a motor that is in free running, accelerating it from the rotation in which it is. The Ride-Through function allows recovering the inverter, with no locking by undervoltage, when there is an instant drop in the power supply.

Both functions assume the special case in which the motor is running in the same direction and at a frequency close to the frequency reference, thus, by immediately applying the frequency reference to the output and increasing the output voltage in ramp, the slip and the starting torque are minimized.

P320 - Flying Start / Ride-Through

Adjustable Range:	0 = Inactive 1 = Flying Start 2 = FS / RT 3 = Ride-Through	Factory Setting:	0
Properties:	cfg		

Description:

It allows the use of the Flying Start and Ride-Through functions.

- **Flying Start Function (FS):** In order to activate this function, just program P320 in 1 or 2; thus the inverter will impose a fixed frequency at the start, defined by the frequency reference, and apply the voltage ramp defined in parameter P331. In this way, the start current is reduced. On the other hand, if the motor is at rest, the frequency reference and the real frequency of the motor are very different or the direction of rotation is inverted; the result in such cases may be worse than the conventional start without Flying Start.

The Flying Start function is applied on loads with high inertia or systems that require start with the motor spinning. Besides, the function may be deactivated dynamically by a digital input P263 to P266 programmed

for “24 = Disable Flying Start”. In this way, the user may activate the function in a convenient way according to the application.

- Ride-Through Function (RT):** The Ride-Through function will disable the inverter output pulses (IGBT) as soon as the supply voltage reaches a value below the undervoltage value. A fault due to undervoltage (F021) does not occur and the DC link voltage will slowly drop until the supply voltage returns. In case it takes the supply voltage too long to return (over 2 seconds), the inverter may indicate F021 (undervoltage on the DC link). If the supply voltage returns before, the inverter will enable the pulses again, imposing the frequency reference instantly (like in the Flying Start function) and making a voltage ramp with time defined by parameter P331. Refer to [Figure 8.7 on page 8-11](#).

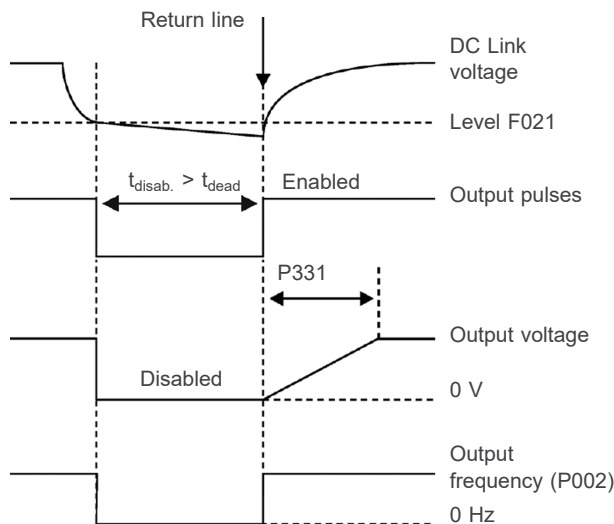

Figure 8.7: Actuation of the Ride-Through function

The Ride-Through function allows recovering the inverter without locking by undervoltage F021 for momentary power supply drops. The time interval accepted during a fault is at most two seconds.

P331 - Voltage Ramp for FS and RT

Adjustable Range:	0.2 to 60.0 s	Factory Setting:	2.0 s
--------------------------	---------------	-------------------------	-------

Description:

It defines the rising time of the output voltage during the execution of the Flying Start and Ride-Through functions.

P332 - Dead Time

Adjustable Range:	0.1 to 10.0 s	Factory Setting:	1.0 s
--------------------------	---------------	-------------------------	-------

Description:

It defines the minimum time the frequency inverter will wait until driving the motor again with the Ride Through function, which is necessary to demagnetize the motor.

8.1.4 DC Braking

The DC Braking allows stopping the motor by applying direct current to it. The current applied at the DC Braking is proportional to the braking torque and may be set in P302. It is set in percentage (%) of the inverter rated current considering the motor of power compatible with the inverter.

MOTOR CONTROL

P299 - DC Braking Start Time

Adjustable Range: 0.0 to 15.0 s

Factory Setting: 0.0 s

Description:

It defines the DC braking duration at the start.

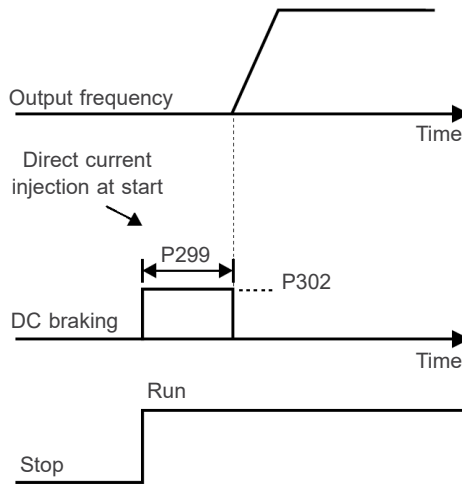

Figure 8.8: DC Braking actuation at start

P300 - DC Braking Stop Time

Adjustable Range: 0.0 to 15.0 s

Factory Setting: 0.0 s

Description:

It defines the DC Braking duration at the stop. [Figure 8.9 on page 8-12](#) shows the braking behavior at the stop.

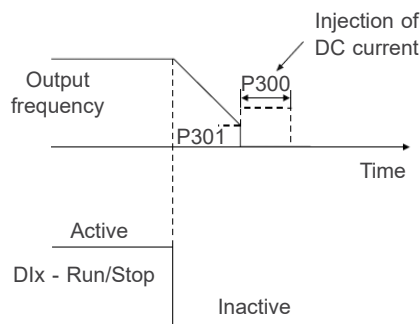

Figure 8.9: DC Braking actuation at the stop with command

During the braking process, if the inverter is enabled, the braking is interrupted and the inverter will start operating normally.



ATTENTION!

The DC Braking can continue acting even if the motor has already stopped. Be careful with the thermal dimensioning of the motor for short-period cyclic braking.

P301 - DC Braking Frequency

Adjustable Range:	0.0 to 15.0 Hz	Factory Setting:	3.0 Hz
--------------------------	----------------	-------------------------	--------

Description:

It defines the initial point to apply the DC Braking at the stop when the inverter is disabled by ramp, according to [Figure 8.9 on page 8-12](#).

P302 - DC Braking Current

Adjustable Range:	0.0 to 100.0 %	Factory Setting:	20.0 %
--------------------------	----------------	-------------------------	--------

Description:

It defines the DC current (DC braking torque) applied to the motor during the braking.

The setting must be done by gradually increasing the value of P302, which varies from 0.0 to 100.0 % of the rated braking voltage, until the desired braking is obtained.

If the inverter has a power too much higher than the motor, the braking torque will be too low. On the other hand, if the opposite is true, overcurrent may occur during the braking, as well as overheating of the motor. A value too high in P302 may cause overcurrent faults on the inverter and even damages to the connected motor by overcurrent on the windings.



NOTE!

A value too high in P302 may cause overcurrent faults on the inverter and even damages to the connected motor by overcurrent on the windings.

8.1.5 Dynamic Braking

The braking torque that can be obtained through the application of frequency inverters without dynamic braking resistors varies from 10 % to 35 % of the motor rated torque.

In order to obtain higher braking torques, resistors for dynamic braking are used. In this case the regenerated energy is dissipated on the resistor mounted externally to the inverter.

This type of braking is used in the cases when short deceleration times are wished or when high inertia loads are driven.



NOTE!

The Dynamic Braking function can only be used if a braking resistor has been connected to the inverter, and if the parameters related to it have been adjusted properly.

P153 - Dynamic Braking Level

Adjustable Range:	348 to 800 V	Factory Setting:	According to the Inverter Model
--------------------------	--------------	-------------------------	---------------------------------

Description:

It defines the voltage level for the braking IGBT actuation, and it must be compatible with the power supply voltage.

If P153 is set at a level too close to the overvoltage actuation level (F022), it may occur before the braking

MOTOR CONTROL

resistor can dissipate the motor regenerated energy. [Table 8.2 on page 8-14](#) contains the adjustment ranges for the actuation of the dynamic braking according to the model.

Table 8.2: Dynamic braking actuation range

Input Voltage	Actuation Range	Factory Setting
110 to 127 Vac	391 to 460 Vdc	395 Vdc
200 to 240 Vac	349 to 410 Vdc	365 Vdc
380 Vac	621 to 800 Vdc	800 Vdc
400 to 415 Vac	646 to 800 Vdc	800 Vdc
440 to 460 Vac	716 to 800 Vdc	800 Vdc
480 Vac	747 to 800 Vdc	800 Vdc

[Figure 8.10 on page 8-14](#) shows an example of typical dynamic braking actuation, where the hypothetical wave shapes of the voltage on the braking resistor and the DC link voltage can be observed. Thus, when the braking IGBT connects the link to the external resistor, the DC link voltage drops below the value set by P153, keeping the level below fault F022.

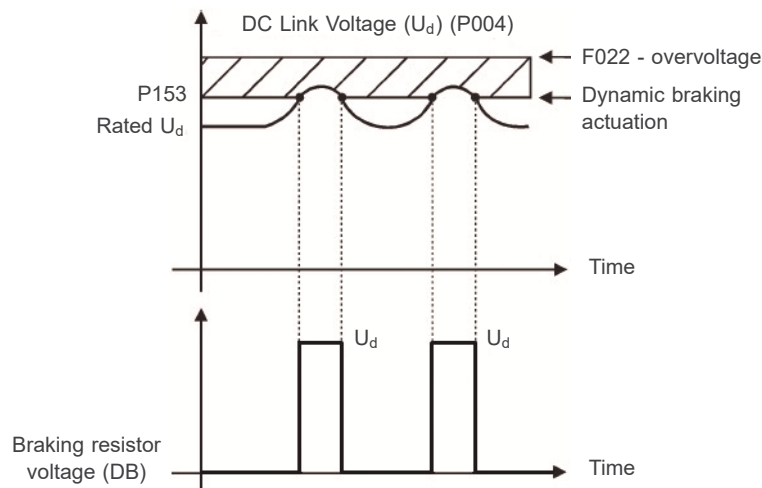

Figure 8.10: Dynamic braking actuation curve

Steps to enable the dynamic braking:

- With the inverter powered down, connect the braking resistor (Refer to the user's manual of the Inverter).
- Set P151 at the maximum value: (According to inverter model) to prevent the activation of the DC voltage regulation before the dynamic braking.



DANGER!

Be sure the inverter is OFF and disconnected before handling the electric connections and read carefully the installation instructions of the user's manual.

8.1.6 Skip Frequency

This inverter function prevents the motor from operating permanently at frequency values in which, for example, the mechanical system goes into resonance (causing excessive vibration or noises).

P303 - Skip Frequency 1

P304 - Skip Frequency 2

Adjustable Range: 0.0 to 400.0 Hz

Factory Setting: 0.0 Hz

Description:

It defines the center of the frequency range avoided, according to [Figure 8.11 on page 8-15](#).

P306 - Skip Band

Adjustable Range: 0.0 to 25.0 Hz

Factory Setting: 0.0 Hz

Description:

It defines the skip frequency band. The actuation of those parameters is done as presented in [Figure 8.11 on page 8-15](#) below. The passage by the skip frequency band ($2 \times P306$) is done through acceleration/deceleration ramp. The function does not operate correctly if two bands of "Skip Frequency" overlap.

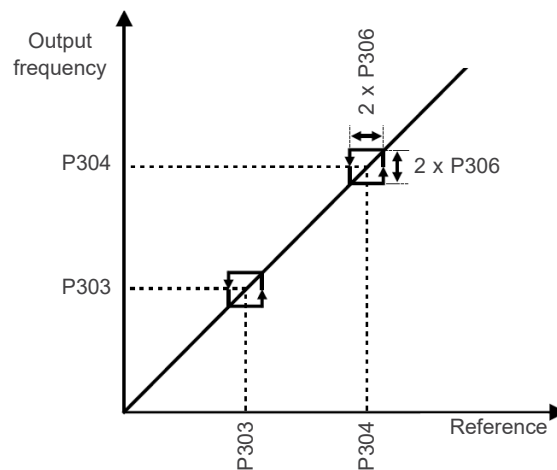

Figure 8.11: Actuation of the skip frequency

8.1.7 Fire Mode

The "Fire Mode" function is intended to make the frequency inverter continue to drive the motor even under adverse conditions, inhibiting most faults generated by the frequency inverter. The "Fire Mode" is activated by driving a digital input previously set to "Fire Mode" with logic level "0" at the input terminals. When the drive enters the "Fire Mode", the alarm "A211" will be generated on the HMI (keypad) and the status of the operation mode will be updated in parameter P006.



DANGER!

"FIRE MODE" FUNCTION - RISK OF DEATH!

- Notice that the inverter is only one of the components of the system, and it is configurable for several functions that must be pre-established in the project.
- Therefore, the full operation of the "Fire Mode" function, with the required safety, depends on the specification in the project, as it also requires the compatibility with all the other components of the system and the installation environment.
- Ventilation systems that operate in life safety applications must be approved by the Fire Department and/or another competent local public authority.
- The activation of the "Fire Mode" function disables essential protection functions for the safety of the frequency inverter and of the system as a whole.
- The non-interruption of the frequency inverter operation due to the improper activation of the "Fire Mode" function is critical, as it may cause injuries or even death, and damages to the frequency inverter, to the other components of the system and to the environment where it is installed.
- The operation in the "Fire Mode" function may, under certain circumstances, result in fire, as the protection devices will be disabled.
- Only qualified personnel from safety engineer departments must evaluate and activate the equipment Fire Mode function.
- It is essential to follow the aforementioned instructions before using the frequency inverter in the "Fire Mode" function.

Under no circumstance shall WEG take any liability for deaths, damages, compensations and/or losses occurred due to the improper programming or operation of the frequency inverter in the "Fire Mode" function.

IMPORTANT - RISK OF DEATH!

When activating the "Fire Mode" function, the user must be aware of the fact that the protection functions of the frequency inverter will be disabled, which may result in damages:

1. to the inverter;
2. to the components connected to it;
3. to the environment where it is installed;
4. to the people present in the place.

Therefore, the operator who activates the "Fire Mode" function takes full liability for the resulting risks. The operation of the inverter with the "Fire Mode" function programmed voids the warranty of the product.

The operation in this condition is internally registered by the frequency inverter, and it may be validated by an engineer and occupational safety professional duly qualified by the manufacturer.



NOTE!

When activating the "Fire Mode" function, the user acknowledges that the protection functions of the frequency inverter are disabled, which may result in damages to the frequency inverter, to the components connected to it, to the environment in which it is installed and to the people present in such environment. Therefore, the user takes full liability for the resulting risks. The operation of the inverter with the "Fire Mode" function enabled voids the warranty of the product. The operation under such condition is internally registered by the frequency inverter and must be validated by an engineer and occupational safety professional duly qualified. If the user presses the **P** key, the message will disappear from the display (A211), but the operation mode will continue to be shown in parameter P006. It is also possible to indicate this condition in a digital output (DOx) previously programmed for "Fire Mode". During the operation in "Fire Mode", all the stop commands are ignored (even General Enable). Some Faults (considered critical) that may damage the inverter will not be disabled, but they can be infinitely reset automatically (define this condition in parameter P582): Overvoltage on the DC Link (F022), Overcurrent/Short Circuit (F070).

P580 - Fire Mode Configuration

Adjustable Range:	0 = Inactive 1 = Active 2 = Active / P134 3 = Reserved 4 = Active / General Disable	Factory Setting: 0
Properties:	cfg	

Description:

It defines how the Fire Mode functionality will work in the frequency inverter.

Table 8.3: Options for the parameter P580

Option	Description
0	Fire Mode function is inactive
1	Fire Mode function is active. When the DIx set to Fire Mode is opened, "A211" will be shown on the HMI and no changes will be made to the speed reference or to the inverter control
2	Fire Mode function is active. When the DIx set to Fire Mode is opened, "A211" will be shown on the HMI and the Speed Reference will be set automatically to maximum (P134) value. The motor will accelerate to this new reference
3	Reserved
4	Fire Mode function is active. When the DIx set to Fire Mode is opened, "A211" will be shown on the HMI and the pulses in the output will be disabled. Motor will coast to stop

P582 - Fire Mode Auto-reset Adjustable

Adjustable Range:	0 = Limited 1 = Unlimited	Factory Setting: 0
Properties:	cfg	

Description:

It defines how the auto-reset functionality will work in Fire Mode when a critical fault occur (DC Link Overvoltage (F022) and Overcurrent/Short-circuit (F070)).

Table 8.4: Options for the parameter P582

Option	Description
0	Limited. Auto-reset works as defined in P340 parameter
1	Unlimited. The auto-reset happens after 1s of a critical failure detection regardless of the value set in P340

8.1.8 Control Configuration

P397 - Control Config

Adjustable Range:	0 to F (hexa) Bit 0 = Slip Compens. Regen. Bit 1 = Dead Time Comp. Bit 2 = Is Stabilization Bit 3 = P297 reduction in A050	Factory Setting: 11
Properties:	cfg	

Description:

It allows internal options to configure the control of the induction motor. The bits of parameter P397 are enable according as shown in [Table 8.5 on page 8-18](#) and described as:

MOTOR CONTROL

■ **Slip Compensation during the Regeneration (Bit 0)**

The regeneration is an operating mode of the inverter which occurs when the power flux goes from the motor to the inverter. The bit 0 of P397 (set in 0) allows the slip compensation to be turned off in this situation. This option is particularly useful when the compensation during the motor deceleration is necessary.

■ **Dead Time Compensation (Bit 1)**

The dead time is a time interval introduced in the PWM necessary for the commutation of the power inverter bridge. On the other hand, the dead time generates distortions on the voltage applied to the motor, which can cause torque reduction at low speeds and current oscillation in motors above 5 HP running with no load. Thus, the dead time compensation measures the voltage pulse width in the output and compensates this distortion introduced by the dead time. This parameter must be kept always in 1 (On). Only in special maintenance cases the value 0 (Off) can be used.

■ **Output Current Stabilization (Bit 2)**

High-performance motors with power above 5 HP are marginally stable when driven by frequency inverters and at operation with no load. Therefore, in this situation a resonance may occur in the output current which may reach the overcurrent level F070. Bit 2 of P397 (set to 1) activates an algorithm for regulation of the output current in closed loop which neutralizes the oscillations of resonant output current.

■ **Reduction of P297 at high temperature (Bit 3)**

Bit 3 of P397 controls the action to reduce the switching frequency together with the overtemperature protection according to [Table 11.2 on page 11-4](#). If the temperature exceeds the value of A050, the switching frequency is reduced proportionally down to its minimum when the temperature reaches the level of F051.



NOTE!

Both the function related to P219 and the function controlled by P397 (bit 3) act by reducing the switching frequency. As the function related to P219 is intended to improve the reading of the inverter current, that function has priority of action over the function controlled by P397 (bit 3).



ATTENTION!

The default setting of P397 meets most application needs of the inverter. Therefore, avoid modifying its content without knowing the related consequences. If you are not sure, contact WEG Technical Assistance before changing P397.

Table 8.5: Options available to configure the control (P397)

P397	Bit 3 Reduction of P297 in A050	Bit 2 Output Current Stabilization	Bit 1 Dead Time Compensation	Bit 0 Slip Compensation During Regeneration
0000h	Disabled	Disabled	Disabled	Disabled
0001h	Disabled	Disabled	Disabled	Enabled
0002h	Disabled	Disabled	Enabled	Disabled
0003h	Disabled	Disabled	Enabled	Enabled
0004h	Disabled	Enabled	Disabled	Disabled
0005h	Disabled	Enabled	Disabled	Enabled
0006h	Disabled	Enabled	Enabled	Disabled
0007h	Disabled	Enabled	Enabled	Enabled
0008h	Enabled	Disabled	Disabled	Disabled
0009h	Enabled	Disabled	Disabled	Enabled
000Ah	Enabled	Disabled	Enabled	Disabled
000Bh	Enabled	Disabled	Enabled	Enabled
000Ch	Enabled	Enabled	Disabled	Disabled
000Dh	Enabled	Enabled	Disabled	Enabled
000Eh	Enabled	Enabled	Enabled	Disabled
000Fh	Enabled	Enabled	Enabled	Enabled

8.2 V/F

This is the classical control method for three-phase induction motors, based on a curve that relates output frequency and voltage. The inverter works as a variable frequency and voltage source, generating a combination of voltage and frequency according to the configured curve. It is possible to adjust this curve for standard 50 Hz, 60 Hz or special motors.

According to the block diagram of [Figure 8.12 on page 8-20](#), the frequency reference f^* is limited by P133 and P134 and applied to the input of “V/f Curve” block, where the output voltage amplitude and frequency imposed to the motor are obtained. For further details on the frequency reference, refer to [Section 7.2 SPEED REFERENCE on page 7-6](#).

By monitoring the total and active output current, and the DC link voltage, compensators and regulators are implanted so as to help in the protection and performance of the V/f control. The operation and parameterization of those blocks are detailed in [Section 8.1 COMMON FUNCTIONS on page 8-1](#).

The advantage of the V/f control is its simplicity and the need of few settings. The start-up is quick and simple and the factory default, in general, requires little or no modification. In cases whose objective is to reduce losses on the motor and inverter, the “Quadratic V/f” may be used, where the flow in the motor air-gap is proportional to the output frequency up to the field weakening point (also defined by P142 and P145). Thus, the result is a torque capacity as a quadratic function of the frequency. The great advantage of such control is the capacity to save energy when driving loads with variable resistant torque, due to the reduction of motor losses (especially losses in the air-gap, magnetic losses).

The V/f or scalar control is recommended for the following cases:

- Drive of several motors with the same inverter (multi-motor drive).
- Energy saving in the drive of loads with quadratic torque/frequency relationship.
- Motor rated current lower than 1/3 of the inverter rated current.
- For test purposes, the inverter is turned on without motor or with a small motor with no load.
- Applications where the load connected to the inverter is not a three-phase induction motor.
- Applications that aim at reducing losses on the motor and inverter (Quadratic V/f).

The V/f curve is completely adjustable in four different points as according to [Figure 8.13 on page 8-21](#), although the factory default set a curve pre-adjusted for motors 50 Hz or 60 Hz, as options for P204. This format, point P₀ defines the amplitude applied at 0 Hz, while P₂ defines the rated amplitude and frequency and beginning of field weakening. Intermediate points P₁ allow the setting of the curve for a non-linear relationship between torque and frequency, for instance, in fans where the load torque is quadratic in relation to the frequency. The field weakening region is determined between P₂ and P₃, where the amplitude is maintained in 100 %.

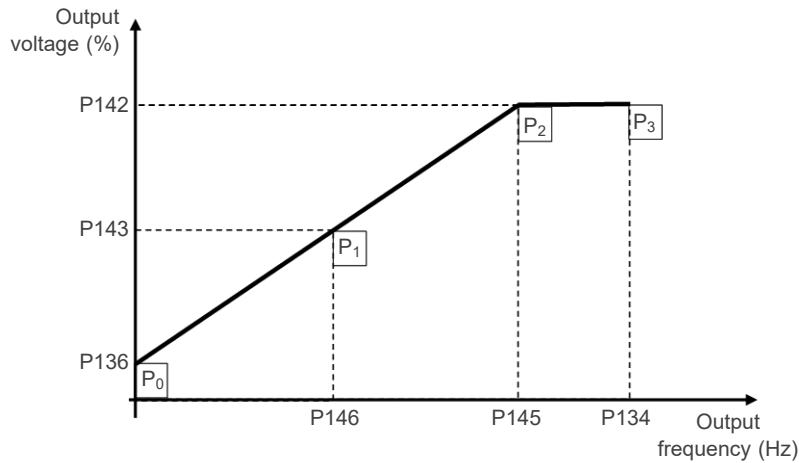

Figure 8.13: V/f curve

The factory default setting of the frequency inverter defines a linear relation of the torque with the frequency by means of three points (P₀, P₁ and P₂).

The points P₀[P136, 0 Hz], P₁[P143, P146], P₂[P142, P145] and P₃[100 %, P134] can be set so that the voltage and frequency relation imposed to the output approximates the ideal curve for the load. Therefore, for loads in which the torque behavior is quadratic in relation to the frequency, such as in centrifugal pumps and fans, the points of the curve can be set or the Quadratic V/f control mode can be used so as to save energy. This Quadratic V/f curve is presented in [Figure 8.14 on page 8-21](#).

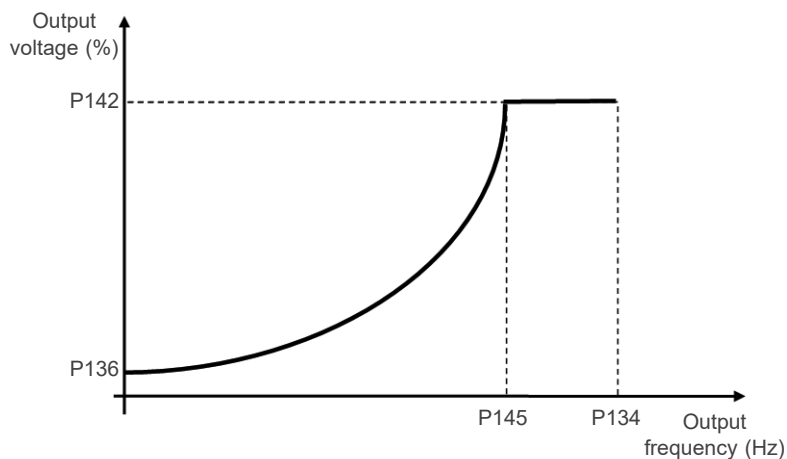

Figure 8.14: Quadratic V/f Curve



NOTE!

In frequencies below 0.1 Hz, the output PWM pulses are cut, except when the inverter is in DC Braking mode.



NOTE!

Read chapter 3 Installation and Connection of the frequency inverter user's manual before installing, energizing or operating the inverter.

Sequence for installation, verification, power up and start-up:

1. Install the inverter: according to chapter 3 Installation and Connection of the user's manual, making all the power and control connections.
2. Prepare and power up the inverter according to Section 3.2 Electrical Installation of the user's manual of the frequency inverter.
3. Load the factory default with P204 = 5 (60 Hz) or P204 = 6 (50 Hz), according to the input rated frequency (power supply) of the inverter used.
4. Set the value of P296 according to the rated supply voltage (only for the 400 V Line).
5. In order to set a V/f curve different from the default, set the V/f curve using parameters P136 to P146.
6. Setting of specific parameters and functions for the application: program the digital and analog inputs and outputs, HMI keys, etc., according to the application requirements.

P136 - Manual Torque Boost

Adjustable Range:	0.0 to 30.0 %	Factory Setting:	According to the Inverter Model
Properties:	V/f		

Description:

It defines in percentage increase of the applied voltage. It actuates at low speeds, that is, in the range 0 to P146 (V/f) or 0 to P145 (Quadratic V/f), increasing the inverter output voltage so as to compensate the voltage drop in the motor stator resistance in order to keep the torque constant.

The optimum setting is the smallest value of P136 which allows the motor satisfactory start. A value greater than necessary will excessively increase the motor current at low speeds, which may lead the inverter to a fault condition (F051 or F070) or alarm condition (A046 or A050), as well as motor overheating. [Figure 8.15 on page 8-22](#) and [Figure 8.16 on page 8-23](#) show the actuation regions of the Torque Boost for the V/f and Quadratic V/f mode, respectively.

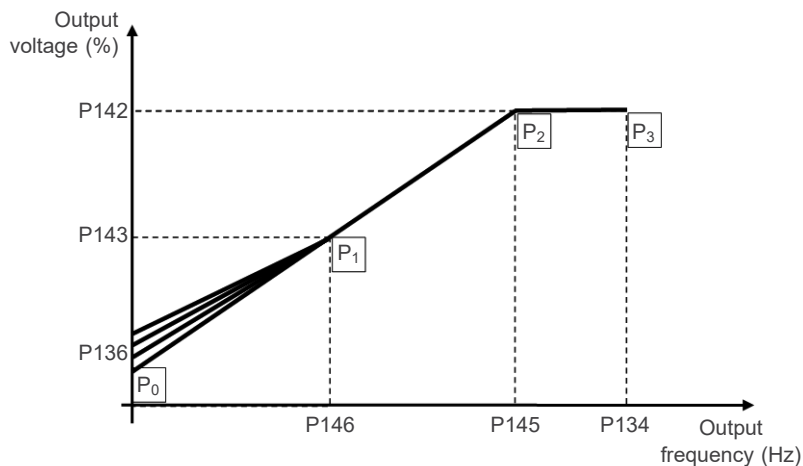

Figure 8.15: Torque boost region for quadratic V/f control mode

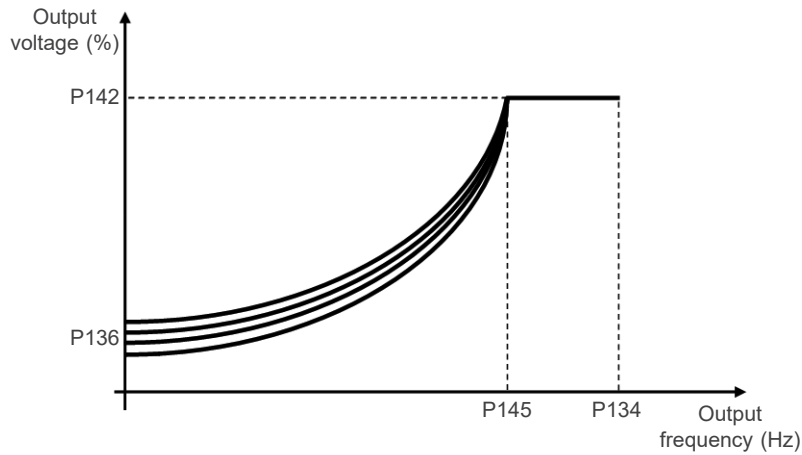

Figure 8.16: Torque boost region for quadratic V/f control mode

P137 - Automatic Torque Boost

Adjustable Range:	0.0 to 30.0 %	Factory Setting:	0.0 %
Properties:	V/f		

Description:

It defines percentage of compensation of the voltage drop in the stator resistance as a function of the active current. Look at Figure 8.12 on page 8-20, where variable IxR corresponds to the automatic torque boost action on the modulation index defined by V/f curve.

P137 actuates similarly to P136, but the value set is applied proportionally to the output active current in relation to the maximum current (2 x P295).

The setting criteria of P137 are the same as those of P136, that is, set the value as low as possible for the motor start and operation at low frequencies, because values above those increase the losses, heating and overload of the motor and inverter.

The block diagram of Figure 8.17 on page 8-23 shows the automatic compensation action IxR responsible for the increment of the voltage in the ramp output according to the increase of the active current.

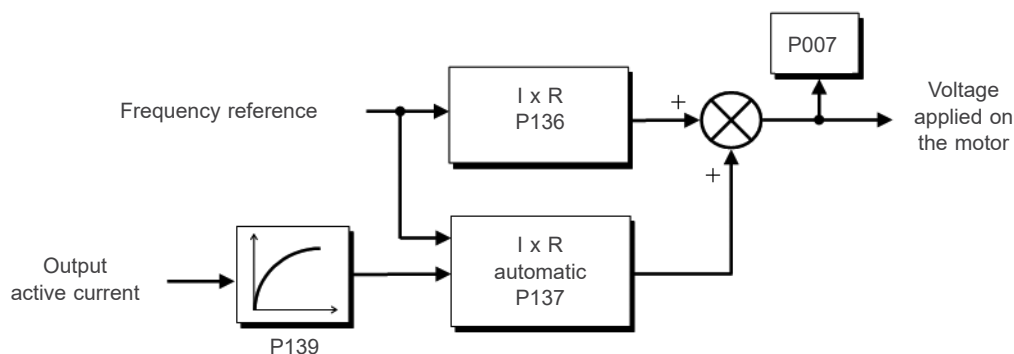

Figure 8.17: Block diagram of the automatic torque boost

P138 - Slip Compensation

Adjustable Range:	-10.0 to 10.0 %	Factory Setting:	0.0 %
Properties:	V/f		

MOTOR CONTROL

Description:

Defines the percentage of compensation of the speed drop due to the application of the load on the shaft and, consequently, the slip. Parameter P138 is used in the motor slip compensation function, when set for positive values. In this case, it compensates the speed drop due to the application of load on the shaft and, consequently, the slip. Thus, it increments the output frequency (Δf) considering the increase of the motor active current, as shown in [Figure 8.18 on page 8-24](#). In [Figure 8.12 on page 8-20](#) this compensation is represented in the variable f_{Slip} .

The setting in P138 allows regulating with good accuracy the slip compensation by moving the operation point on the V/f curve, as shown in [Figure 8.18 on page 8-24](#). Once P138 is set, the inverter is able to keep the frequency constant even with load variations.

Negative values are used in special applications where you wish to reduce the output frequency considering the increase of the motor current.

Eg.: load distribution in motors driven in parallel.

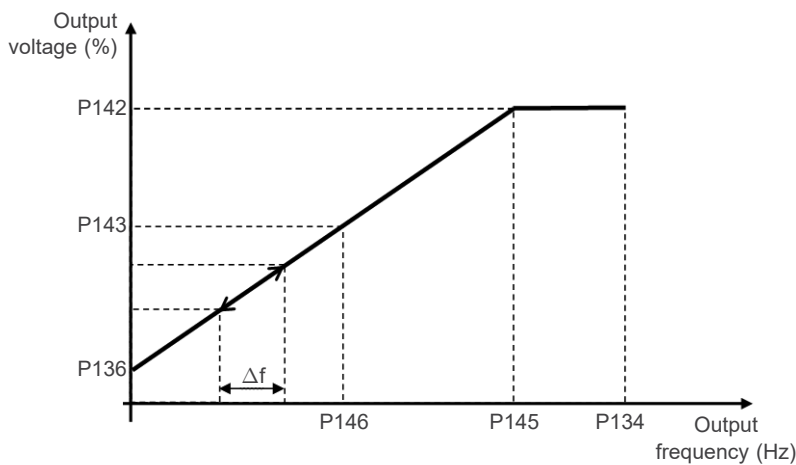

Figure 8.18: Slip compensation in an operation point of the standar V/f curve

P142 - Maximum Output Voltage

Adjustable Range:	0.0 to 100.0 %	Factory Setting:	100.0 %
Properties:	cfg, V/f		

P143 - Intermediate Output Voltage

Adjustable Range:	0.0 to 100.0 %	Factory Setting:	50.0 %
Properties:	cfg, V/f		

Description:

It allows adjusting the inverter V/f curve together with its orderly pairs P145 and P146.

P145 - Field Weakening Speed

Adjustable Range:	0.0 to 400.0 Hz	Factory Setting:	60.0 (50.0) Hz
Properties:	cfg, V/f		

P146 - Intermediate Frequency

Adjustable Range:	0.0 to 400.0 Hz	Factory Setting:	30.0 (25.0) Hz
Properties:	cfg, V/f		

Description:

It allows adjusting the inverter V/f curve together with its orderly pairs P142 and P143.

The V/f curve can be adjusted in applications where the motor rated voltage is smaller than the power supply voltage, for example, a power supply of 220 V with motor of 200 V.

The adjustment of the V/f curve is necessary when the motor has a frequency different from 50 Hz or 60 Hz, or when a quadratic approximation is desired for energy saving in centrifugal pumps and fans, or in special applications: when a transformer is used between the inverter and the motor or the inverter is used as a power supply.

8.2.1 Energy Saver (EOC)

The efficiency of a machine is defined as being the ratio between the output mechanical power and the input electrical power. Remember that the mechanical power is the product between torque and rotor speed, and that the input electric power is the sum of the output mechanical power and the motor losses.

In the case of the three-phase induction motor, the optimized efficiency is achieved with $\frac{3}{4}$ of the rated load. In the region below this point, the Energy Saving function has its best performance.

The Energy Saving function acts directly on the voltage applied on the inverter output; thus, the flux relationship delivered to the motor is changed so as to reduce the motor losses and enhance the efficiency, consequently reducing consumption and noise.

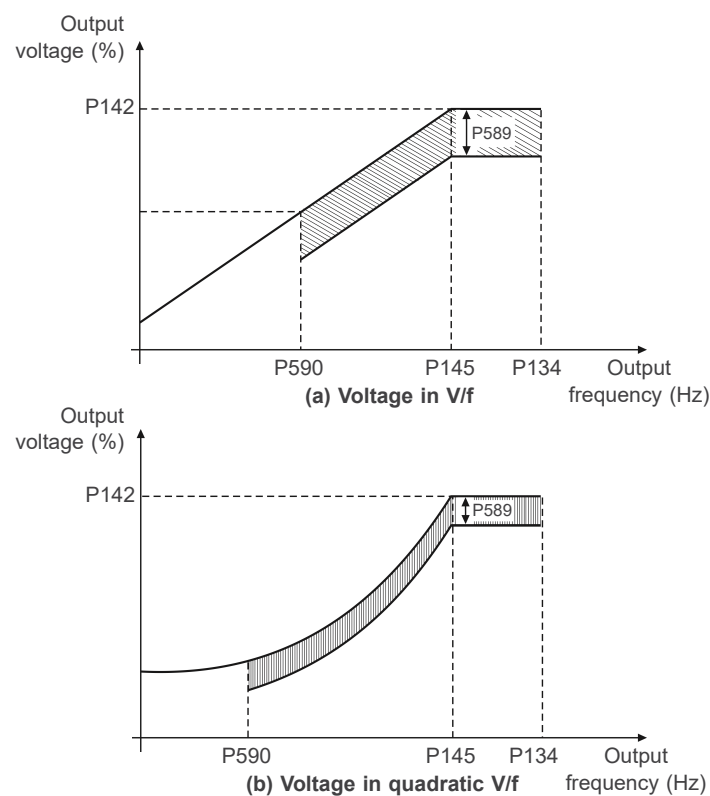

Figure 8.19: (a) and (b) Example of voltage behavior in V/f and quadratic V/f

The function will be active when the motor load is below the maximum value (P588) and the frequency is above the minimum value (P590). In addition, in order to prevent the stalling of the motor, the applied voltage is

MOTOR CONTROL

limited to a minimum acceptable value (P589). The parameter group presented in the sequence defines the characteristics necessary for the energy saving function.



NOTE!

The use of the energy saving function is recommended in quadratic torque applications (blowers, fans, pumps and compressors).

P011 - Power Factor

Adjustable Range: 0.00 to 1.00

Factory Setting:

Properties: ro

Description:

It indicates the power factor, that is, the relationship between the real power and the total power absorbed by the motor.

P407 - Motor Rated Power Factor

Adjustable Range: 0.50 to 0.99

Factory Setting: According to the Inverter Model

Properties: cfg, VVW

Description:

It defines the motor rated power factor.

In order to obtain the proper operation of the energy saving function, the motor power factor must be correctly set, according to the information on the motor nameplate.

Note: With the motor nameplate data and for applications with constant torque, the motor optimum efficiency is normally obtained with the energy saving function active. In some cases, the output current may increase, and then it is necessary to gradually reduce the value of this parameter to the point in which the current value remains equal to or below the current value obtained with the function disabled.

For information regarding the actuation of P407 in the VVW control mode, refer to [Section 8.3 VVW on page 8-27](#).

P588 - EOC Maximum Torque

Adjustable Range: 0 to 85 %

Factory Setting: 0 %

Properties: cfg, V/f

Description:

It defines the torque value to activate the operation of the energy saving function. Setting this parameter to 0 % disables the function.

It is recommended to set this parameter to 60 %, but it has to be set according the application requirements.

P589 - EOC Minimum Voltage

Adjustable Range:	40 to 80 %	Factory Setting:	40 %
Properties:	cfg, V/f		

Description:

It defines the minimum voltage value that will be applied to the motor when the energy saving function is active. This minimum value is relative to the voltage imposed by the V/f curve for a certain speed.

P590 - EOC Minimum Frequency

Adjustable Range:	12.0 to 400.0 Hz	Factory Setting:	20.0 Hz
Properties:	cfg, V/f		

Description:

It defines the minimum speed value at which the energy saving function will remain active.

The hysteresis for the minimum speed level is of 2 Hz.

P591 - EOC Hysteresis

Adjustable Range:	0 to 30 %	Factory Setting:	10 %
Properties:	cfg, V/f		

Description:

It defines the hysteresis used to activate and deactivate the energy saving function.

If the function is active and the output current oscillates, it is necessary to increase the hysteresis value.



NOTE!

It is not possible to set those parameters, while the motor is spinning.

8.3 VVW

The VVW vector control mode (Voltage Vector WEG) uses a control method with a much higher performance than the V/f control because of the load torque estimation and of the control of the magnetic flux in the air gap, as per scheme of [Figure 8.20 on page 8-28](#). In this control strategy, losses, efficiency, rated slip and power factor of the motor are considered in order to improve the control performance.

The main advantage compared to the V/f control is the best frequency regulation with greater torque capacity at low speeds (frequencies below 5 Hz), allowing a relevant improvement in the drive performance in permanent duty. Besides, the VVW control has a quick and simple setting and it is suitable for most medium-performance applications in the control of three-phase induction motor.

By just measuring the output current, the VVW control instantly obtains the motor torque and slip. Thus, the VVW actuates in the output voltage compensation and slip compensation. Therefore, the VVW controller action replaces the classical V/f functions in P137 and P138, but with a calculation model much more sophisticated and accurate, meeting several load conditions or operation points of the application.

In order to achieve a good frequency regulation in permanent duty with a good operation of the VVW control, the parameter setting in the range P399 to P407, and the stator resistance in P409 are essential for the good operation of the VVW control. These parameters can be easily obtained on the motor nameplate.

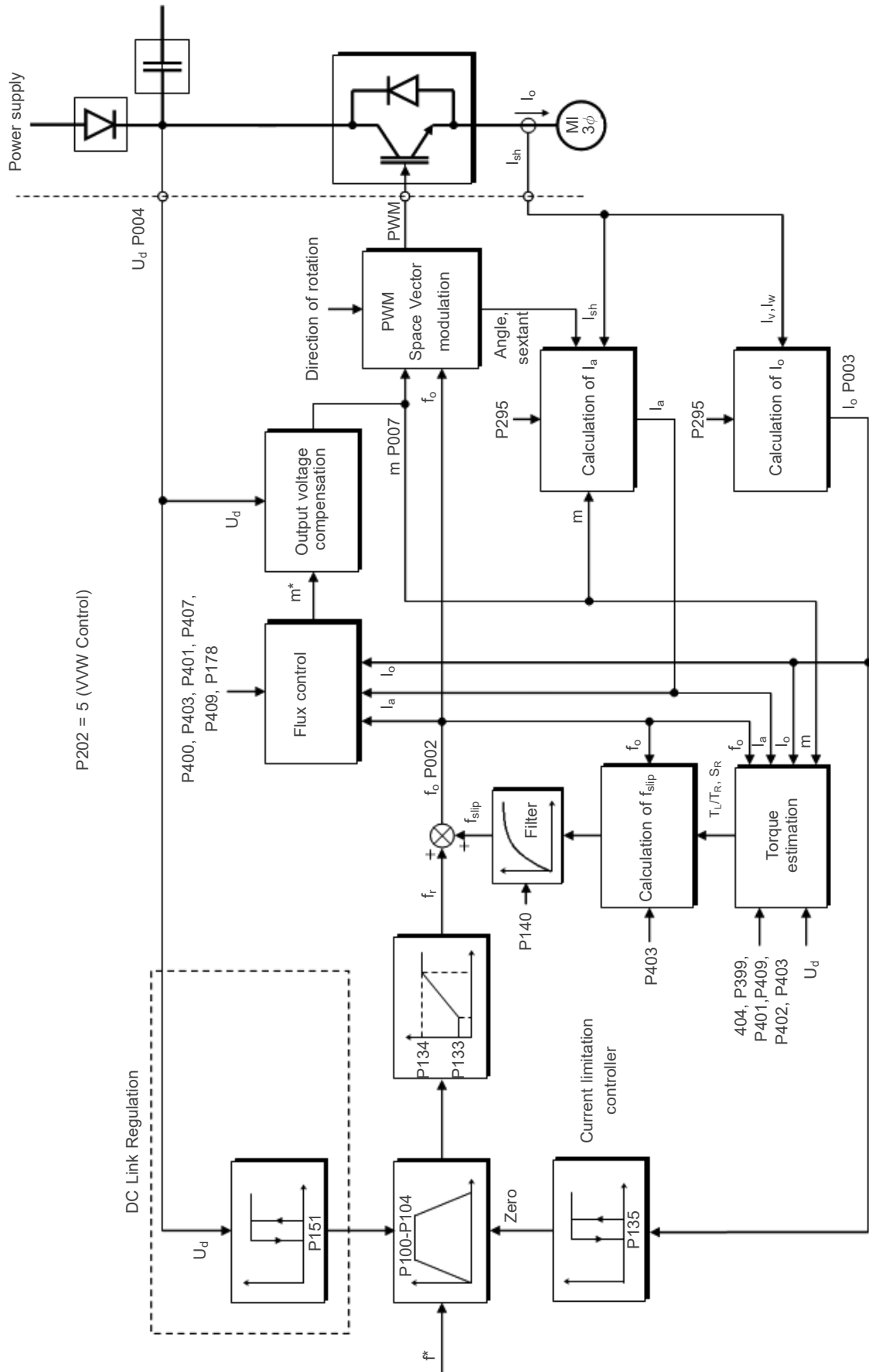

Figure 8.20: VFW control flow

Opposite to the V/f scalar control, the VVW control requires a series of data from the motor nameplate and a self-tuning for its proper operation. Besides, it is recommended that the driven motor match the inverter, that is, the motor and inverter power be as close as possible.

Below are described the parameters to configure the VVW vector control setting. This data is easily obtained on WEG standard motor nameplates, however in older motors or motors made by other manufacturers, the data may not be readily available.

In those cases, it is recommended first contact the motor manufacturer, measure or calculate the desired parameter. As a last resort, the user always can make a relationship with [Table 8.6 on page 8-30](#) and use the equivalent or approximate WEG standard motor parameter.

**NOTE!**

The correct setting of the parameters directly contributes to the VVW control performance.

MOTOR CONTROL

Table 8.6: Characteristics of IV pole WEG standard motors (indicative values)

Power		Frame Size	Voltage [P400] (V)	Current [P401] (A)	Frequency [P403] (Hz)	Speed [P402] (rpm)	Efficiency [P399] (%)	Power Factor	Stator Resistance [P409] (Ω)
(HP)	(kW)								
0.16	0.12	63	220	0.85	60	1720	56.0	0.66	21.77
0.25	0.18	63		1.12		1720	64.0	0.66	14.87
0.33	0.25	63		1.42		1720	67.0	0.69	10.63
0.5	0.37	71		2.07		1720	68.0	0.69	7.37
0.75	0.55	71		2.90		1720	71.0	0.70	3.97
1.00	0.75	80		3.08		1730	78.0	0.82	4.13
1.50	1.10	80		4.78		1700	72.7	0.83	2.78
2.00	1.50	90S		6.47		1720	80.0	0.76	1.55
3.00	2.20	90L		8.57		1710	79.3	0.85	0.99
4.00	3.00	100L		11.6		1730	82.7	0.82	0.65
5.00	3.70	100L		13.8		1730	84.6	0.83	0.49
0.16	0.12	63	380	0.49	60	1720	56.0	0.66	65.30
0.25	0.18	63		0.65		1720	64.0	0.66	44.60
0.33	0.25	63		0.82		1720	67.0	0.69	31.90
0.5	0.37	71		1.20		1720	68.0	0.69	22.10
0.75	0.55	71		1.67		1720	71.0	0.70	11.90
1.00	0.75	80		1.78		1730	78.0	0.82	12.40
1.50	1.10	80		2.76		1700	72.7	0.83	8.35
2.00	1.50	90S		3.74		1720	80.0	0.76	4.65
3.00	2.20	90L		4.95		1710	79.3	0.85	2.97
4.00	3.00	100L		6.70		1730	82.7	0.82	1.96
5.00	3.70	100L		7.97		1730	84.6	0.83	1.47
6.00	4.50	112M		9.41		1730	84.2	0.86	1.15
7.50	5.50	112M		11.49		1740	88.5	0.82	0.82
10.0	7.50	132S		15.18		1760	89.0	0.84	0.68
0.16	0.12	63	230	0.73	50	1375	57.0	0.72	30.62
0.25	0.18	63		1.05		1360	58.0	0.74	20.31
0.33	0.25	71		1.4		1310	59.0	0.76	14.32
0.50	0.37	71		1.97		1320	62.0	0.76	7.27
0.75	0.55	80		2.48		1410	68.0	0.82	5.78
1.00	0.75	80		3.26		1395	72.0	0.81	4.28
1.50	1.10	90S		4.54		1420	77.0	0.79	2.58
2.00	1.50	90L		5.81		1410	79.0	0.82	1.69
3.00	2.20	100L		8.26		1410	81.5	0.82	0.98
4.00	3.00	100L		11.3		1400	82.6	0.81	0.58
5.00	3.70	112M		14.2		1440	85.0	0.83	0.43
0.16	0.12	63	400	0.42	50	1375	57.0	0.72	91.85
0.25	0.18	63		0.60		1360	58.0	0.74	60.94
0.33	0.25	71		0.80		1310	59.0	0.76	42.96
0.50	0.37	71		1.13		1320	62.0	0.76	21.81
0.75	0.55	80		1.42		1410	68.0	0.82	17.33
1.00	0.75	80		1.86		1395	72.0	0.81	12.85
1.50	1.10	90S		2.61		1420	77.0	0.79	7.73
2.00	1.50	90L		3.34		1410	79.0	0.82	5.06
3.00	2.20	100L		4.75		1410	81.5	0.82	2.95
4.00	3.00	100L		6.47		1400	82.6	0.81	1.75
5.00	3.70	112M		8.18		1440	85.0	0.83	1.29
7.50	5.50	132S		11.0		1450	86.0	0.84	0.76
10.0	7.50	132M		14.8		1455	87.0	0.84	0.61



NOTE!

Read chapter 3 Installation and Connection of the frequency inverter user's manual before installing, energizing or operating the inverter.

Sequence for installation, verification, power up and start-up:























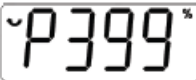





1. **Install the inverter:** according to chapter 3 Installation and Connection of the user's manual, making all the power and control connections.

2. **Prepare and power up the inverter:** according to Section 3.2 Electrical Installation of the user's manual.
3. **Load the correct factory default in P204:** based on the motor rated frequency (set P204 = 5 for 60 Hz motors and P204 = 6 for 50 Hz motors).
4. **Setting of specific parameters and functions for the application:** program the digital and analog inputs and outputs, HMI keys, etc., according to the application requirements.
5. **Activation of the VVW control:** set P202 = 5 and parameters P399, P400, P401, P402, P403, P404 and P407 according to the motor nameplate. Also set the value of P409. If some of those data are not available, enter the approximate value by calculation or by similarity with WEG standard motor, see the [Table 8.6 on page 8-30](#).
6. **Self-Tuning of the VVW control:** the self-tuning is activated by setting P408 = 1. In this process, the inverter applies DC to the motor to measure the stator resistance, while the HMI bar graph shows the progress of the self-tuning. The self-tuning process can be interrupted at any time by pressing the **P** key.
7. **End of the Self-Tuning:** at end of the self-tuning, the HMI returns to the browsing menu, the bar displays the parameter programmed by P207 again and the stator resistance measured is stored in P409. On the other hand, if the self-tuning fails, the inverter will indicate a fault. The most common fault in this case is F033, which indicates error in the estimated stator resistance. Refer to [Chapter 10 FAULTS AND ALARMS on page 10-1](#).

For better visualization of the start-up in the VVW mode, check [Table 8.7 on page 8-32](#).

MOTOR CONTROL

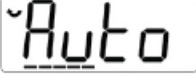
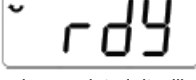
Table 8.7: Start-up of the VVW mode

Seq	Indication on the Display / Action	Seq	Indication on the Display / Action
1	 <ul style="list-style-type: none"> Initialization mode Press this  key to enter the first level of the setting mode 	2	 <ul style="list-style-type: none"> Press the  or  keys until selecting parameter P296
3	 <ul style="list-style-type: none"> If necessary, change the content of "P296 - Line Rated Voltage" (only for 400 V line) Press the  key until selecting parameter P202 	4	 <ul style="list-style-type: none"> Press the  key to change the content of "P202 - Control Type" to P202 = 5 (VVW) Use the  key
5	 <ul style="list-style-type: none"> Press the  key to save the change of P202 Use the  key until selecting parameter P399 	6	 <ul style="list-style-type: none"> If necessary, change the content of "P399 - Motor Rated Efficiency" according to data on the nameplate Press the  key for the next parameter
7	 <ul style="list-style-type: none"> If necessary, change the content of "P400 - Motor Rated Voltage" Press the  key for the next parameter 	8	 <ul style="list-style-type: none"> If necessary, change the content of "P401 - Motor Rated Current" Press the  key for the next parameter
9	 <ul style="list-style-type: none"> If necessary, change the content of "P402 - Motor Rated Speed" Press the  key for the next parameter 	10	 <ul style="list-style-type: none"> If necessary, change the content of "P403 - Motor Rated Frequency" Press the  key for the next parameter
11	 <ul style="list-style-type: none"> If necessary, change the content of "P404 - Motor Rated Output" Press the  key for the next parameter 	12	 <ul style="list-style-type: none"> If necessary, change the content of "P407 - Motor Rated Power Factor" Press the  key for the next parameter
13	 <ul style="list-style-type: none"> If necessary to make the self-tuning, change the value of P408 to "1" 	14	 <ul style="list-style-type: none"> During the self-tuning, the HMI will show "Auto" and the bar will indicate the operation progress
15	 <ul style="list-style-type: none"> When the self-tuning is completed, it will return to the Initialization Mode 	16	 <ul style="list-style-type: none"> If necessary, change the content of "P409 - Stator Resistance"

P140 - Slip Com. Filter

Adjustable Range: 0.000 to 9.999 s

Factory Setting: 0.500 s

Properties: VVW

Description:

It defines the time constant of the filter for slip compensation in the output frequency. You must consider a filter response time equal to three times the time constant set in P140.

P178 - Rated Flux

Adjustable Range:	50.0 to 150.0 %	Factory Setting:	100.0 %
Properties:	V/f, VVW		

Description:

It defines the desired flux in the motor air gap in percentage (%) of the rated flux. In general, it is not necessary to modify the value of P178 of the standard value of 100.0 %. However, some specific situations may use values slightly above to increase the torque, or below to reduce the energy consumption.

P399 - Motor Rated Efficiency

Adjustable Range:	50.0 to 99.9 %	Factory Setting:	According to the Inverter Model
Properties:	cfg, VVW		

Description:

It defines the rated motor efficiency. This parameter is important for the precise operation of the VVW control. A misconfiguration will cause incorrect calculation of the slip compensation, reducing the performance of the speed control.

P400 - Motor Rated Voltage

Adjustable Range:	0 to 480 V	Factory Setting:	220 (230) V
Properties:	cfg, VVW		

Description:

It defines the rated motor voltage. Set according to the data on the motor nameplate and the wire connection on the motor terminal box. Default values are shown in the [Table 8.8 on page 8-33](#). This value cannot be above the rated voltage value set in P296 (power supply rated voltage).

Table 8.8: Default setting of P400 according to the identified inverter model

P296	P145 (Hz)	P400 (V)
0	Reserved	Reserved
1	50.0	230
	60.0	220
2	50.0	230
	60.0	220
3	Reserved	Reserved
4	50/60	380
5	50/60	415
6	50/60	440
7	50/60	480

For further information on model identification, refer to [Table 6.1 on page 6-3](#) of [Chapter 6 FREQUENCY INVERTER IDENTIFICATION on page 6-1](#).

MOTOR CONTROL

P401 - Motor Rated Current

Adjustable Range:	0.0 to 40.0 A	Factory Setting:	1.0 x I _{nom}
Properties:	cfg, VVW		

Description:

It defines the rated motor current. Parameter P401 must be set according to the information on the motor nameplate, taking into account the motor voltage.



NOTE!

It is not recommended setting the motor rated current greater than inverter rated current (P295).

P402 - Motor Rated Speed

Adjustable Range:	0 to 24000 rpm	Factory Setting:	1720 (1310) rpm
Properties:	cfg, VVW		

Description:

It defines the rated motor speed. Parameter P402 must be set according to the information on the motor nameplate.

The setting of parameter P402 via HMI for values above 9999 rpm is performed from 10.00 to 30.00 rpm (x 1000).

P403 - Motor Rated Frequency

Adjustable Range:	0 to 400 Hz	Factory Setting:	60 (50) Hz
Properties:	cfg, VVW		

Description:

It defines the rated motor frequency. Parameter P403 must be set according to the information on the motor nameplate.

P404 - Motor Rated Power

Adjustable Range:	0 = 0.16 HP (0.12 kW) 1 = 0.25 HP (0.18 kW) 2 = 0.33 HP (0.25 kW) 3 = 0.50 HP (0.37 kW) 4 = 0.75 HP (0.55 kW) 5 = 1.00 HP (0.75 kW) 6 = 1.50 HP (1.10 kW) 7 = 2.00 HP (1.50 kW) 8 = 3.00 HP (2.20 kW) 9 = 4.00 HP (3.00 kW) 10 = 5.00 HP (3.70 kW) 11 = 5.50 HP (4.00 kW) 12 = 6.00 HP (4.50 kW) 13 = 7.50 HP (5.50 kW) 14 = 10.00 HP (7.50 kW)	Factory Setting:	According to the Inverter Model
Properties:	cfg, VVW		

Description:

It defines the rated motor power. Parameter P404 must be set according to the information on the motor nameplate.

P408 - Run Self-Tuning

Adjustable Range:	0 = No 1 = Yes	Factory Setting:	0
Properties:	cfg, VVW		

Description:

It allows the self-tuning of the VVW mode, where the motor stator resistance is measured. The self-tuning can only be activated via HMI, and it can be interrupted at any time with the  key.

During the self-tuning, the bar graph shows the progress of the operation and the motor remains still, because a DC signal is sent to measure the stator resistance.

If the estimated value of the motor stator resistance is too high for the inverter used (for example: motor not connected or motor too small for the inverter) the inverter indicates fault F033.

At the end of the self-tuning process, the measured motor stator resistance is saved in P409.



NOTE!

The self-tuning will not run if the inverter is in Alarm or Fault.

P409 - Stator Resistance

Adjustable Range:	0.01 to 99.99	Factory Setting:	According to the Inverter Model
Properties:	cfg, V/f, VVW		

Description:

It defines the motor phase stator resistance in ohms (Ω). This value can be estimated by Self-Tuning.

MOTOR CONTROL

If the value adjusted in P409 is too high or too low for the inverter used, the inverter indicates fault F033. In order to exit this condition, just perform a reset by using the  key, in this case, P409 will be loaded with the factory default value.

9 I/O

This chapter contains the parameters for setting the inverter inputs and outputs. This setting depends on the accessory connected to the product.



NOTE!

The inverter HMI only displays the parameters related to the resources available in the accessory connected to the product.

9.1 ANALOG INPUTS

For example, the use of an external frequency reference is possible via the analogue inputs. The details for this configuration are described in the following parameters.

Each analog input of the inverter is defined by the steps of calculation of Signal, Offset, Gain, Filter, Function and Value Alx, as shown in Figure 9.1 on page 9-1.

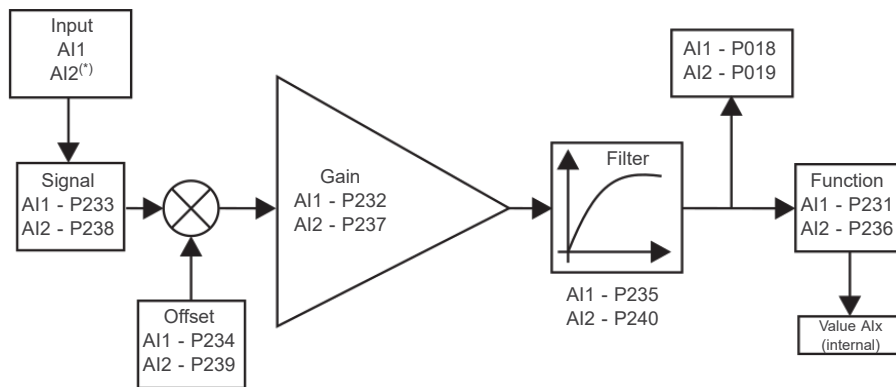

(*) Control terminal available on the IO's expansion accessory.

Figure 9.1: Block diagram of the analog inputs - (Alx)

P018 - AI1 Value

P019 - AI2 Value

Adjustable Range:	-100.0 to 100.0 %	Factory Setting:
Properties:	ro	

Description:

It indicates the value of the analog inputs in percentage of the full scale. The indicated values are those obtained after the offset action and multiplication by the gain. Check the description of parameters P230 to P245.

P230 - Dead Zone (AIs and FI1)

Adjustable Range:	0 = Inactive 1 = Active	Factory Setting:	0
Properties:	cfg		

Description:

It defines if the dead zone acts for the analog input (Alx) or for the frequency input (FI), programmed as frequency reference, is Active (1) or Inactive (0).

If the parameter is configured as Inactive (P230 = 0), the signal in the analog inputs will actuate on the frequency reference from the minimum point (0 V / 0 mA / 4 mA or 10 V / 20 mA), and it will be directly related to the minimum frequency set in P133. Check [Figure 9.2 on page 9-2](#).

If the parameter is set as Active (P230 = 1), the signal in the analog inputs will have a dead zone, where the frequency reference remains at the Minimum frequency value (P133), even with the variation of the input signal. Check [Figure 9.2 on page 9-2](#).

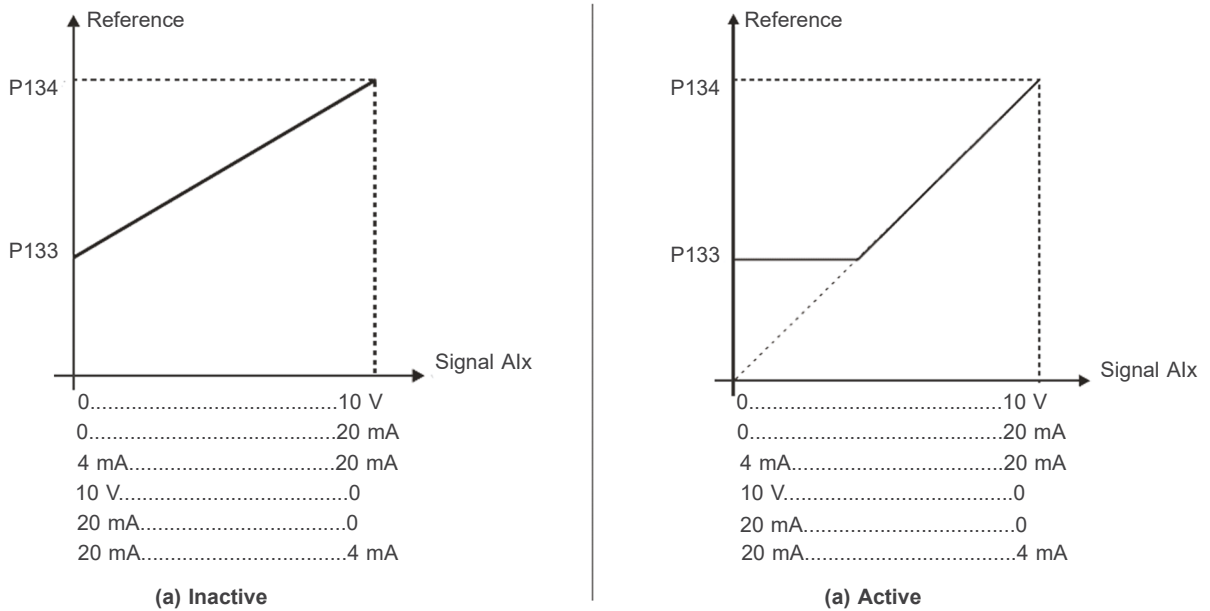

Figure 9.2: (a) and (b) Actuation of the analog inputs with dead zone

P231 - AI1 Signal Function

P236 - AI2 Signal Function

Adjustable	0 = Speed Ref.	Factory	P231 = 0
Range:	1 to 3 = Not Used	Setting:	P236 = 0
	4 = PTC		
	5 to 6 = Not Used		
	7 = PLC Use		
	8 = Application Function 1		
	9 = Application Function 2		
	10 = Application Function 3		
	11 = Application Function 4		
	12 = Application Function 5		
	13 = Application Function 6		
	14 = Application Function 7		
	15 = Application Function 8		
	16 = Control Setpoint		
	17 = Process Variable		
Properties:	cfg		

Description:

It defines the analog input function.

When the 0 option (Speed Reference) is selected, the analog input can provide the frequency reference for the

motor, subject to the specified limits (P133 and P134) and to the action of the ramps (P100 to P103). However, it is also necessary to configure parameters P221 and/or P222 by selecting the analog input. For further details, see the description of those parameters in [Chapter 7 COMMAND AND REFERENCES on page 7-1](#).

Option 4 (PTC) configures the input to monitor the motor temperature. For further details on this function, refer to [Section 10.3 PROTECTIONS on page 10-3](#).

Option 7 (PLC Use), as well as options 8 to 15, configures the input to be used by the programming done in the memory area reserved for the SoftPLC function. For further details, refer to the help menu of the WPS software.

Options 16 and 17 configure the input for the use of the PID Controller application (P903 = 1). For further details, see [Chapter 14 APPLICATIONS on page 14-1](#).

P232 - AI1 Input Gain

P237 - AI2 Input Gain

Adjustable Range:	0.000 to 9.999	Factory Setting:	1.000
--------------------------	----------------	-------------------------	-------

Description:

It defines the gain of the analog input.

Each analog input of the inverter is defined by the steps of calculation of Signal, Offset, Gain, Filter, Function and Value AIx, as shown in [Figure 9.1 on page 9-1](#).

P233 - AI1 Input Signal

P238 - AI2 Input Signal

Adjustable Range:	0 = 0 to 10 V / 20 mA 1 = 4 to 20 mA 2 = 10 V / 20 mA to 0 3 = 20 to 4 mA	Factory Setting:	P233 = 0 P238 = 0
--------------------------	--	-------------------------	----------------------

Description:

It configures the signal type (if current or voltage) that will be read in each analog input, as well as its variation range. In options 2 and 3 of the parameters, the reference is inverse, that is, the maximum frequency is obtained with the minimum reference.

Pay attention to the connections of the analog input with voltage or current signal according to the inverter used. For analog inputs on expansion accessories, refer to the installation, configuration, and operation guide of the I/O expansion accessory used.

Table 9.1: Alx configuration and equation

Signal	P233 or P238	Equation Alx(%)
0 to 10 V	0	$Alx(\%) = \left(\frac{Alx(V)}{10 V} \times (100.0 \%) + \text{offset} \right) \times \text{gain}$
0 to 20 mA	0	$Alx(\%) = \left(\frac{Alx(mA)}{20 mA} \times (100.0 \%) + \text{offset} \right) \times \text{gain}$
4 to 20 mA	1	$Alx(\%) = \left(\frac{Alx(mA) - 4 mA}{16 mA} \times (100.0 \%) + \text{offset} \right) \times \text{gain}$
10 to 0 V	2	$Alx(\%) = 100 \% - \left(\frac{Alx(V)}{10 V} \times (100.0 \%) + \text{offset} \right) \times \text{gain}$
20 to 0 mA	2	$Alx(\%) = 100 \% - \left(\frac{Alx(mA)}{20 mA} \times (100.0 \%) + \text{offset} \right) \times \text{gain}$
20 to 4 mA	3	$Alx(\%) = 100 \% - \left(\frac{Alx(mA) - 4 mA}{16 mA} \times (100.0 \%) + \text{offset} \right) \times \text{gain}$

For example: Alx = 5 V, offset = -70.0 %, gain = 1.000, with signal of 0 to 10 V, that is, Alx_{ini} = 0 and Alx_{FE} = 10.

$$Alx(\%) = \left(\frac{5}{10} \times (100.0 \%) + (-70 \%) \right) \times 1.000 = -20.0 \%$$

Another example: Alx = 12 mA, offset = -80.0 %, gain = 1.000, with signal of 4 to 20 mA, that is, Alx_{ini} = 4 and Alx_{FE} = 16.

$$Alx(\%) = \left(\frac{12 - 4}{16} \times (100.0 \%) + (-80 \%) \right) \times 1.000 = -30.0 \%$$

Alx = -30.0 % means that the motor will spin forward with a reference in module equal to 30.0 % of P134, if the signal Alx function is “Frequency Reference”.

In the case of filter parameters (P235), the value set corresponds to the time constant used to filter the input signal read. Therefore, the filter response time is around three times the value of this time constant.

P234 - AI1 Input Offset

P239 - AI2 Input Offset

Adjustable Range:	-100.0 to 100.0 %	Factory Setting:	0.0 %
--------------------------	-------------------	-------------------------	-------

Description:

It defines the offset of the analog inputs.

Each analog input of the inverter is defined by the steps of calculation of signal, offset, gain, filter, function and value Alx, as shown in [Figure 9.1 on page 9-1](#).

P235 - AI1 Input Filter**P240 - AI2 Input Filter**

Adjustable Range:	0.00 to 16.00 s	Factory Setting:	0.00 s
--------------------------	-----------------	-------------------------	--------

Description:

It defines the time of the analog input filter.

9.2 EXTERNAL TEMP. SENSOR INPUT

Depending on the inverter (see the user's manual), there is an exclusive input to connecting an external temperature sensor, in some cases it is an I/O of the inverter itself, in others, the sensor connection is via an expansion module. The parameter to read the temperature is described below.

P375 - External Sensor Temp.

Adjustable Range:	0 to 200 °C	Factory Setting:	
Properties:	ro		

Description:

It indicates the temperature value obtained from an external temperature sensor.

For further details, refer to the installation, configuration and operation guide of the expansion module.

**NOTE!**

When the external sensor is NTC, which is disconnected from the accessory, the frequency inverter will display 999 °C (1830 °F) in parameter P375. If the connection pins of the NTC (accessory connector) are shorted, the value indicated on P375 will be 0 °C (32 °F).

9.3 SIGNAL POTENTIOMETER INPUT

The IOP accessory provides the potentiometer signal value for the frequency inverter. The steps to calculate this value are indicated in the block diagram of the [Figure 9.3 on page 9-5](#).

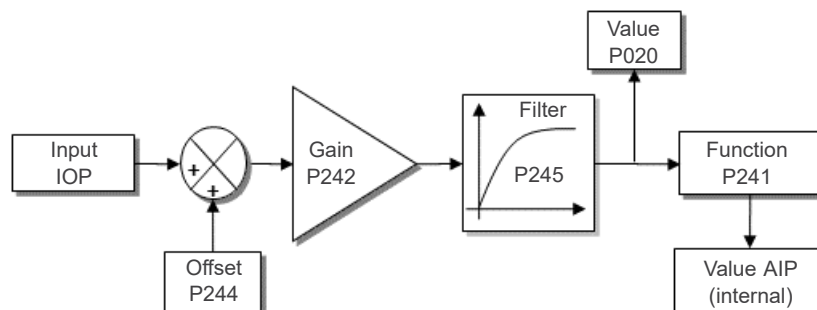

Figure 9.3: Block diagram of the AIP potentiometer signal input

The AIP value can be used as a frequency reference or accessed by the WPS software. The details for the possible configurations are described in the following parameters.

P020 - Potentiometer Signal Value

Adjustable Range:	-100.0 to 100.0 %	Factory Setting:
Properties:	ro	

Description:

It indicates the analog signal value of the AIP potentiometer as a percentage of the full scale. The indicated values are obtained after the offset action and the multiplication by the gain.

P241 - Potentiometer Signal Function

Adjustable Range:	0 = Speed Ref. 1 to 6 = Not Used 7 = SoftPLC 8 = Application Function 1 9 = Application Function 2 10 = Application Function 3 11 = Application Function 4 12 = Application Function 5 13 = Application Function 6 14 = Application Function 7 15 = Application Function 8 16 to 17 = Not Used	Factory Setting: 0
Properties:	cfg	

Description:

It defines the function of the potentiometer signal input.

P242 - Potentiometer Signal Gain

Adjustable Range:	0.000 to 9.999	Factory Setting: 1.000
--------------------------	----------------	-------------------------------

Description:

It defines the gain of the potentiometer signal input.

P244 - Potentiometer Signal Offset

Adjustable Range:	-100.0 to 100.0 %	Factory Setting: 0.0 %
--------------------------	-------------------	-------------------------------

Description:

It defines the offset of the potentiometer signal input.

P245 - Potentiometer and F11 Filter

Adjustable Range:	0.00 to 16.00 s	Factory Setting: 0.00 s
--------------------------	-----------------	--------------------------------

Description:

It defines the filter time constant of the potentiometer signal (when the accessory is connected) and of the

frequency input. It attenuates sudden changes in its value.

9.4 ANALOG OUTPUTS

The analog output (AOx) is configured by means of three types of parameters: Function, Gain and Signal, according to the block diagram in [Figure 9.4 on page 9-7](#).

The quantity of analog outputs depends on the expansion accessory IO's. For further details, refer to the installation, configuration and operation guide of the IO's expansion accessory used.

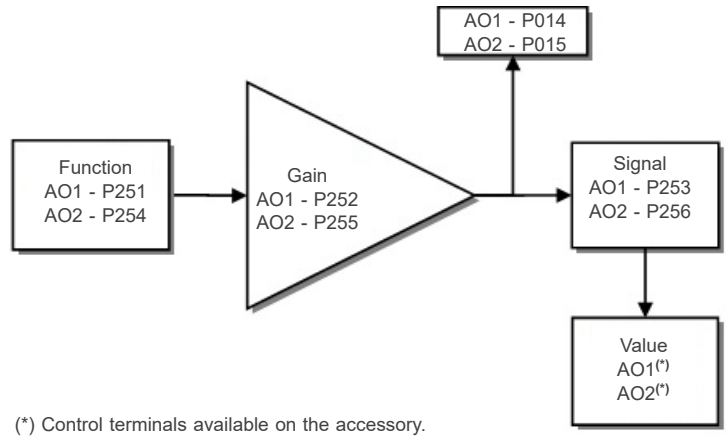

Figure 9.4: Block diagram of the analog output (AOx)

P014 - AO1 Value

P015 - AO2 Value

Adjustable Range:	0.0 to 100.0 %	Factory Setting:
Properties:	ro	

Description:

It indicates the value of analog outputs in percentage of the full scale. The indicated values is obtained after multiplication by the gain. Check the description of the parameters P251 to P256.

P251 - AO1 Output Function**P254 - AO2 Output Function**

Adjustable Range:	0 = Speed Ref. 1 = Not Used 2 = Real Speed 3 to 4 = Not Used 5 = Output Current 6 = Not Used 7 = Active Current 8 to 10 = Not Used 11 = Motor Torque 12 = SoftPLC 13 to 15 = Not Used 16 = Motor Ixt 17 = Not Used 18 = P696 Value 19 = P697 Value 20 = Not Used 21 = Application Function 1 22 = Application Function 2 23 = Application Function 3 24 = Application Function 4 25 = Application Function 5 26 = Application Function 6 27 = Application Function 7 28 = Application Function 8 29 = Control Setpoint 30 = Process Variable	Factory Setting:	P251 = 2 P254 = 5
--------------------------	---	-------------------------	----------------------

Description:

It configures the function of the analog output, according to function and scale presented in [Table 9.2 on page 9-8](#).

Table 9.2: Full scale of the analog output

Function	Description	Full Scale
0	Speed reference at the input of the ramp P001	P134
2	Effective speed at the inverter output	P134
5	Total output current RMS	2 x P295
7	Active Current	2 x P295
11	Torque on the motor in relation to the rated torque	200.0 %
12	SoftPLC scale for analog output	32767
16	Ixt overload of the motor (P037)	100 %
18	Value of P696 for analog output AOx	32767
19	Value of P697 for analog output AOx	32767
21 to 28	Value defined by the SoftPLC application	32767
29	Control Setpoint (PID Controller Application)	(*)
30	Process Variable (PID Controller Application)	(*)

(*) For further details refer the [Chapter 14 APPLICATIONS on page 14-1](#).

P252 - AO1 Output Gain**P255 - AO2 Output Gain**

Adjustable Range:	0.000 to 9.999	Factory Setting:	1.000
--------------------------	----------------	-------------------------	-------

Description:

It defines the analog output gain according to the equations of [Table 9.3 on page 9-9](#).

P253 - AO1 Output Signal**P256 - AO2 Output Signal**

Adjustable Range:	0 = 0 to 10 V 1 = 0 to 20 mA 2 = 4 to 20 mA 3 = 10 to 0 V 4 = 20 to 0 mA 5 = 20 to 4 mA	Factory Setting:	P253 = 0 P256 = 0
--------------------------	--	-------------------------	----------------------

Description:

It configures if the analog outputs signal will be in current or voltage, with direct or reverse reference.

[Table 9.3 on page 9-9](#) below summarizes the configuration and equation of the analog output, where the relationship between the analog output function and the full scale is defined by P251 (AO1) or P256 (AO2), as per [Table 9.2 on page 9-8](#).

Table 9.3: Configuration and equations characteristic of AOx

Signal	P253 or P256	Equation
0 to 10 V	0	$AOx(\%) = \left(\frac{\text{function}}{\text{scale}} \times \text{gain} \right) \times 10 \text{ V}$
0 to 20 mA	1	$AOx(\%) = \left(\frac{\text{function}}{\text{scale}} \times \text{gain} \right) \times 20 \text{ mA}$
4 to 20 mA	2	$AOx(\%) = \left(\frac{\text{function}}{\text{scale}} \times \text{gain} \right) \times 16 \text{ mA} + 4 \text{ mA}$
10 to 0 V	3	$AOx(\%) = 10 \text{ V} - \left(\frac{\text{function}}{\text{scale}} \times \text{gain} \right) \times 10 \text{ V}$
20 to 0 mA	4	$AOx(\%) = 20 \text{ mA} - \left(\frac{\text{function}}{\text{scale}} \times \text{gain} \right) \times 20 \text{ mA}$
20 to 4 mA	5	$AOx(\%) = 20 \text{ mA} - \left(\frac{\text{function}}{\text{scale}} \times \text{gain} \right) \times 16 \text{ mA}$

P696 - AOx Value 1

P697 - AOx Value 2

Adjustable Range: 0 to FFFF (hexa)

Factory Setting:

Properties: ro

Description:

It provides access for monitoring and controlling the inverter by using the communication interfaces. For detailed description, refer to the communication manual (User) according to the interface used. These manuals are they are available for download on the website: www.weg.net.

9.5 FREQUENCY INPUT

A frequency input consists of a fast digital input able to convert the frequency of the pulses in the input into a proportional signal with 15-bit resolution. After the conversion, this signal is used as an analog signal for frequency reference, process variable, for example.

According to the block diagram of [Figure 9.5 on page 9-10](#), the signal in frequency is converted into a digital quantity in 15 bits by means of the block “Calc. Hz / %”, where parameters P248 and P250 define the input signal frequency band, while parameter P022 shows the frequency of the pulses in Hz.

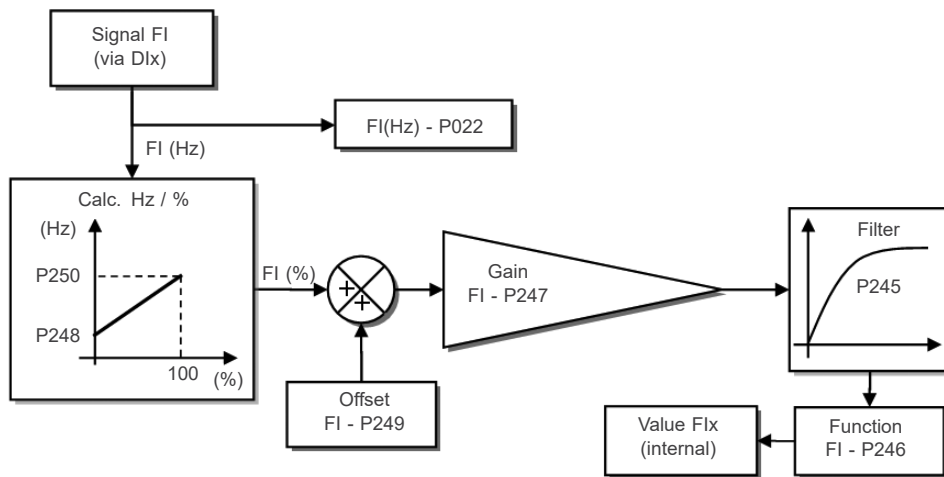

Figure 9.5: Block diagram of frequency input - FI (Dlx)

Digital input Dlx is pre-defined for frequency input via parameter P246, with operating capacity in a wide band from 1 to 3000 Hz.

Parameters P248 and P250 determine the operation range of the frequency input (FI), while parameters P249 and P247 determine the offset and gain, respectively, according to with the equation:

$$FI = \left(\left(\frac{FI (Hz) - P248}{P250 - P248} \right) \times (100 \%) + P249 \right) \times P247$$

For example, FI = 2000 Hz, P248 = 1000 Hz, P250 = 3000 Hz, P249 = -70.0 % and P247 = 1.000, thus:

$$FI = \left(\left(\frac{2000 - 1000}{3000 - 1000} \right) \times (100 \%) - 70 \%\right) \times 1.000 = -20.0 \%$$

The value FI = -20.0 % means that the motor will run in the opposite direction with a reference in module equal 20.0 % of P134, with the function of the FI signal for “Frequency Reference” (P221 = 4).

When P246 = 3, the digital input DI3 is defined for frequency input, regardless the value of P265, with operating

capacity in the band from 0 to 3000 Hz in 10 Vpp.

The time constant of the digital filter for the frequency input is defined by means of parameter P245.

P022 - FI Value in Hz

Adjustable Range:	0 to 3000 Hz	Factory Setting:
Properties:	ro	

Description:

It indicates the value in hertz of the frequency input FI.



NOTE!

The operation of parameters P022 as well as of the frequency input, depends on the configuration of the parameter P246.

P246 - FI1 Input Function

Adjustable Range:	0 = Inactive 1 = Active in DI1 2 = Active in DI2 3 = Active in DI3 4 = Active in DI4	Factory Setting: 0
Properties:	cfg	

Description:

It allows a digital input acts like a frequency input. When set to "0" the frequency input is inactive, keeping parameter P022 at zero. In the other cases, this parameter activates the frequency input on the DIx, making any other function in this digital input DIx (P263-P266) be ignored, and the value of its respective bit in parameter P012 is kept at "0". In order to do so, it is also necessary to configure parameters P221 and/or P222, selecting the use of the frequency input.

P247 - FI1 Input Gain

Adjustable Range:	0.000 to 9.999	Factory Setting: 1.000
--------------------------	----------------	-------------------------------

Description:

It defines the gain of the frequency input.

P248 - FI1 Minimum Input

Adjustable Range:	1 to 3000 Hz	Factory Setting: 100 Hz
--------------------------	--------------	--------------------------------

Description:

It defines the minimum value of the frequency input.

P249 - FI1 Input Offset

Adjustable Range:	-100.0 to 100.0 %	Factory Setting:	0.0 %
--------------------------	-------------------	-------------------------	-------

Description:

It defines the offset of the frequency input.

P250 - FI1 Maximum Input

Adjustable Range:	1 to 3000 Hz	Factory Setting:	1000 Hz
--------------------------	--------------	-------------------------	---------

Description:

It defines the maximum value of the frequency input.

9.6 DIGITAL INPUTS

Below is a detailed description of the parameters for the digital inputs.

P012 - DI8 to DI1 Status

Adjustable Range:	0 to FF (hexa) Bit 0 = DI1 Bit 1 = DI2 Bit 2 = DI3 Bit 3 = DI4 Bit 4 = DI5 Bit 5 = DI6 Bit 6 = DI7 Bit 7 = DI8	Factory Setting:	
Properties:	ro		

Description:

It indicates the status of the digital inputs. Using this parameter, it is possible to view the status of the digital inputs, according to the IO's expansion accessory connected. Refer to parameter P027 in [Section 6.2 ACCESSORIES on page 6-4](#).

The value of P012 is indicated in hexadecimal, where each bit of the number indicates the state of a digital input, that is, if Bit 0 is "0", DI1 is inactive, or if Bit 0 is "1", DI1 is active, and so on up to DI8. Besides, the determination of DIx active or inactive takes into account the type of signal of DIx defined by P271.

The activation of DIx depends on the signal at the digital input and on P271, as per [Table 9.4 on page 9-12](#). Which lists the threshold voltage for activation "V_{TH}", the threshold voltage for deactivation "V_{TL}" and the status indication of DIx in parameter P012.

Table 9.4: Values of P012 for x from 1 to 8

Set in P271	Limit Voltage in DIx	P012
NPN	V _{TL} >10 V	Bit _{x-1} = 0
	V _{TH} <5 V	Bit _{x-1} = 1
PNP	V _{TL} <10 V	Bit _{x-1} = 0
	V _{TH} >20 V	Bit _{x-1} = 1

**NOTE!**

Parameter P012 requires the user to know the conversion between binary and hexadecimal numerical system.

P263 - DI1 Input Function

P264 - DI2 Input Function

P265 - DI3 Input Function

P266 - DI4 Input Function

P267 - DI5 Input Function

P268 - DI6 Input Function

P269 - DI7 Input Function

P270 - DI8 Input Function

Adjustable Range:	0 = Not Used 1 = Run/Stop 2 = General Enable 3 = Quick Stop 4 = Forward Run 5 = Reverse Run 6 = Start 7 = Stop 8 = Direction of Rotation 9 = LOC/REM 10 = JOG 11 = Accelerate E.P. 12 = Decelerate E.P. 13 = Multispeed 14 = 2nd Ramp 15 to 17 = Not Used 18 = No Ext. Alarm 19 = No Ext. Fault 20 = Reset 21 to 23 = Not Used 24 = Disab. Flying Start 25 = Not Used 26 = Lock Prog. 27 = Load User 1 28 = Load User 2 29 to 31 = Not Used 32 = 2nd Ramp Multispeed 33 = 2nd Ramp Increase E.P. 34 = 2nd Ramp Decrease E.P. 35 = 2nd Ramp FWD Run 36 = 2nd Ramp REV Run 37 = Start / Inc. E.P. 38 = Dec. E.P. / Stop 39 = Stop 40 = Stop (Inactive Pulse) 41 = Application Function 1 42 = Application Function 2 43 = Application Function 3 44 = Application Function 4 45 = Application Function 5 46 = Application Function 6 47 = Application Function 7 48 = Application Function 8 49 = Enable Fire Mode 50 to 54 = Not Used 55 = Run/Stop ON-Lock on power-up 56 = Forward Run ON-Lock on power-up 57 = Reverse Run ON-Lock on power-up	Factory Setting:	P263 = 1 P264 = 8 P265 = 0 P266 = 0 P267 = 0 P268 = 0 P269 = 0 P270 = 0
Properties:	cfg		

Description:

It configures the digital input function, according to the adjustable range listed in [Table 9.5 on page 9-16](#).

Table 9.5: Digital Input Functions

Value	Description	Dependence	Figure (Page)
0	Not used	-	-
1	Run/Stop command	P224 = 1 or P227 = 1	9.6 (9-17)
2	General Enable command	-	9.7 (9-17)
3	Quick Stop	P224 = 1 or P227 = 1	9.8 (9-18)
4	Forward run command	(P224 = 1 and P223 = 4) or (P227 = 1 and P226 = 4)	9.9 (9-18)
5	Reverse run command	P224 = 1 or P227 = 1	9.9 (9-18)
6	Start command	P224 = 1 or P227 = 1	9.10 (9-18)
7	Stop command	P224 = 1 or P227 = 1	9.10 (9-18)
8	Forward Rotation Direction	P223 = 4 or P226 = 4	9.11 (9-19)
9	Local/Remote selection	P220 = 4	-
10	JOG command	(P224 = 1 and P225 = 2) or (P227 = 1 and P228 = 2)	9.12 (9-19)
11	Electronic Potentiometer: Accelerate E.P.	P221 = 7 or P222 = 7	9.13 (9-20)
12	Electronic Potentiometer: Decelerate E.P.	P221 = 7 or P222 = 7	9.13 (9-20)
13	Multispeed reference	P221 = 8 or P222 = 8	-
14	2 nd Ramp selection	P105 = 2	9.14 (9-20)
15 to 17	Not used	-	-
18	No external alarm	-	-
19	No external fault	-	-
20	Fault reset	Active fault	-
21 to 23	Not used	-	-
24	Disable flying start	P320 = 1 or 2	-
25	Not used	-	-
26	Lock Prog.	-	-
27	Load User 1	-	9.15 (9-21)
28	Load User 2	-	9.15 (9-21)
29 to 31	Not used	-	-
32	Multispeed reference with 2 nd Ramp	(P221 = 8 or P222 = 8) and P105 = 2	-
33	Electronic Potentiometer: Accelerates E.P. with 2 nd Ramp	(P221 = 7 or P222 = 7) and P105 = 2	-
34	Electronic Potentiometer: Decelerates E.P. with 2 nd Ramp	(P221 = 7 or P222 = 7) and P105 = 2	-
35	Forward run with 2 nd Ramp	(P224 = 1 and P223 = 4) or (P227 = 1 and P226 = 4) and P105 = 2	-
36	Reverse run with 2 nd Ramp	(P224 = 1 and P223 = 4) or (P227 = 1 and P226 = 4) and P105 = 2	-
37	Accelerates E.P./Start	(P224 = 1 or P227 = 1) and (P221 = 7 or P222 = 7)	9.16 (9-22)
38	Decelerates E.P./ Stop	(P224 = 1 or P227 = 1) and (P221 = 7 or P222 = 7)	9.16 (9-22)
39	Stop command	P224 = 1 or P227 = 1	9.17 (9-22)
40	Stop command (Inactive Pulse)	P224 = 1 or P227 = 1	9.18 (9-22)
41	Application Function 1	-	-
42	Application Function 2	-	-
43	Application Function 3	-	-
44	Application Function 4	-	-
45	Application Function 5	-	-
46	Application Function 6	-	-
47	Application Function 7	-	-
48	Application Function 8	-	-
49	Activate Fire Mode	-	-
50	Manual/Automatic PID (Only DI2 for P903 = 1)	(*)	-
51	Increase Setpoint Command (PE) (Only DI3 for P903 = 1)	(*)	-
52	Decrease Setpoint Command (Only DI4 for P903 = 1)	(*)	-
53	1 st DI Control Setpoint (Only DI3 for P903 = 1)	(*)	-
54	2 nd DI Control Setpoint (Only DI4 for P903 = 1)	(*)	-
55	Run/Stop with Lock-ON on power-up	-	-
56	Forward Run with Lock-ON on power-up	-	-
57	Reverse Run with Lock-ON on power-up	-	-

(*) For further details refer the [Chapter 14 APPLICATIONS](#) on page 14-1.

P271 - DI5 Function

Adjustable Range:	0 = (DI1..DI8) NPN 1 = (DI1..DI4) PNP 2 = (DI5..DI8) PNP 3 = (DI1..DI8) PNP	Factory Setting:	0
Properties:	cfg		

Description:

It configures the default for the digital input signal, that is, NPN and the digital input is activated with 0 V, PNP and the digital input is activated with +24 V.

a) RUN/STOP

It enables or disables the motor rotation through the acceleration and deceleration ramp (Figure 9.6 on page 9-17).

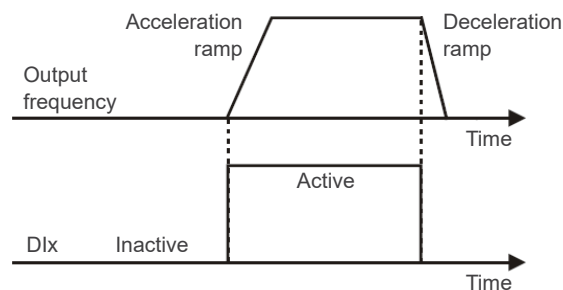

Figure 9.6: Example of the Run/Stop function

b) GENERAL ENABLE

It enables the motor rotation through the acceleration ramp and disables it by cutting off the pulses immediately; the motor stops by inertia (Figure 9.7 on page 9-17).

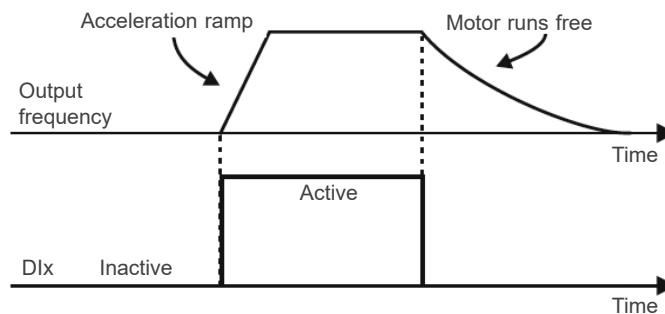

Figure 9.7: Example of the General Enable function

c) QUICK STOP

When inactive, it disables the inverter by the emergency deceleration (P107) (Figure 9.8 on page 9-18).

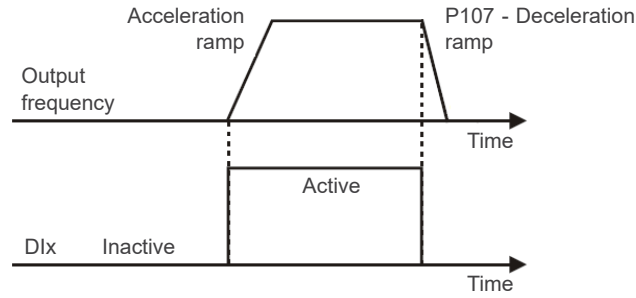

Figure 9.8: Example of the Quick Stop function

d) FORWARD/REVERSE COMMAND

This function is the combination of two DIS: one programmed for forward run and the other for reverse run (Figure 9.9 on page 9-18).

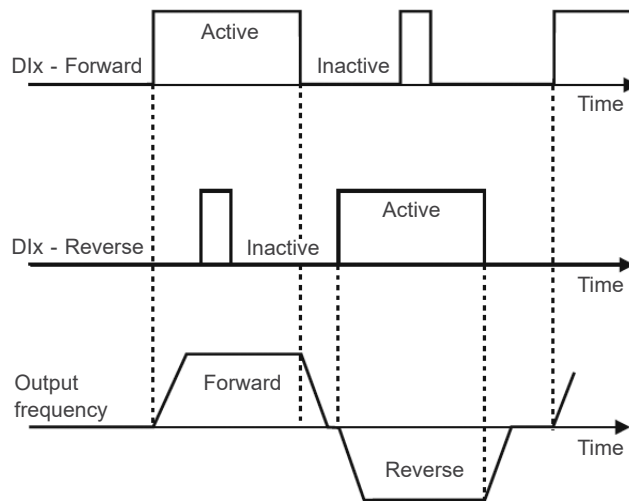

Figure 9.9: Example of the Forward /Reverse command

e) START/STOP

This function tries to reproduce the activation of a three-wire direct start with retention contact, where a pulse in the DlX-Start enables the motor spin while the DlX-Stop is active (Figure 9.10 on page 9-18).

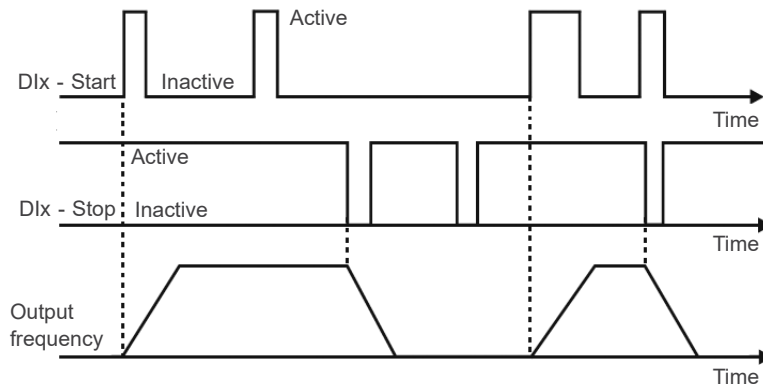

Figure 9.10: Example of the Start/Stop

NOTE! All the digital inputs set for General Enable, Fast Stop, Forward Run/Reverse Run and Start/Stop must be in the “Active” state so that the inverter can enable the motor run.

f) DIRECTION OF ROTATION

If the Dlx is Inactive, the Direction of Rotation is Forward, otherwise, the direction of rotation will be reverse (Figure 9.11 on page 9-19).

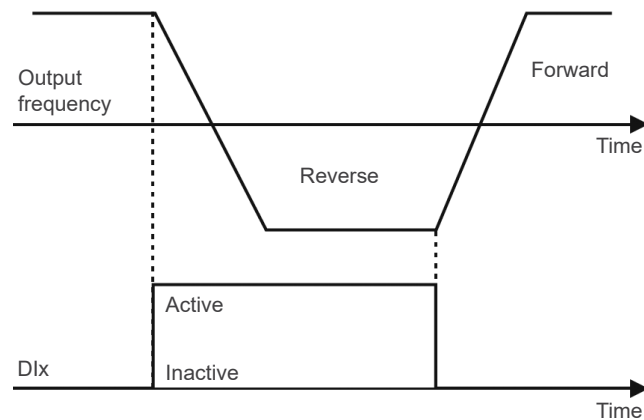

Figure 9.11: Example of the Direction of Rotation function

g) LOCAL/REMOTE

If Dlx is inactive, the Local command is selected, reverse the Remote command is selected.

h) JOG

The JOG command is the combination of the Run/Stop command with a speed reference via parameter P122 (Figure 9.12 on page 9-19).

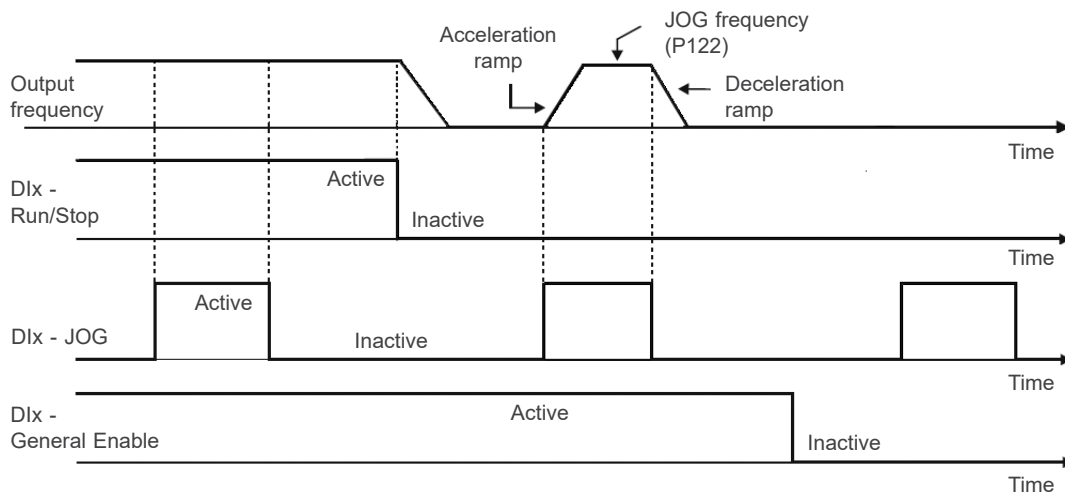

Figure 9.12: Example of the JOG function

i) ELECTRONIC POTENTIOMETER

The E.P. function enables the setting of the speed via digital inputs programmed for Accelerate E.P. and Decelerate E.P. (Figure 9.13 on page 9-20). The basic principle of this function is similar to the sound volume and intensity control of electronic appliances.

The operation of the E.P. function is also affected by the behavior of parameter P120, that is, if P120 = 0 the E.P. reference initial value will be P133; if P120 = 1 the initial value will be the last reference value before the disabling of the inverter, and if P120 = 2, the initial value will be the reference via P121 keys.

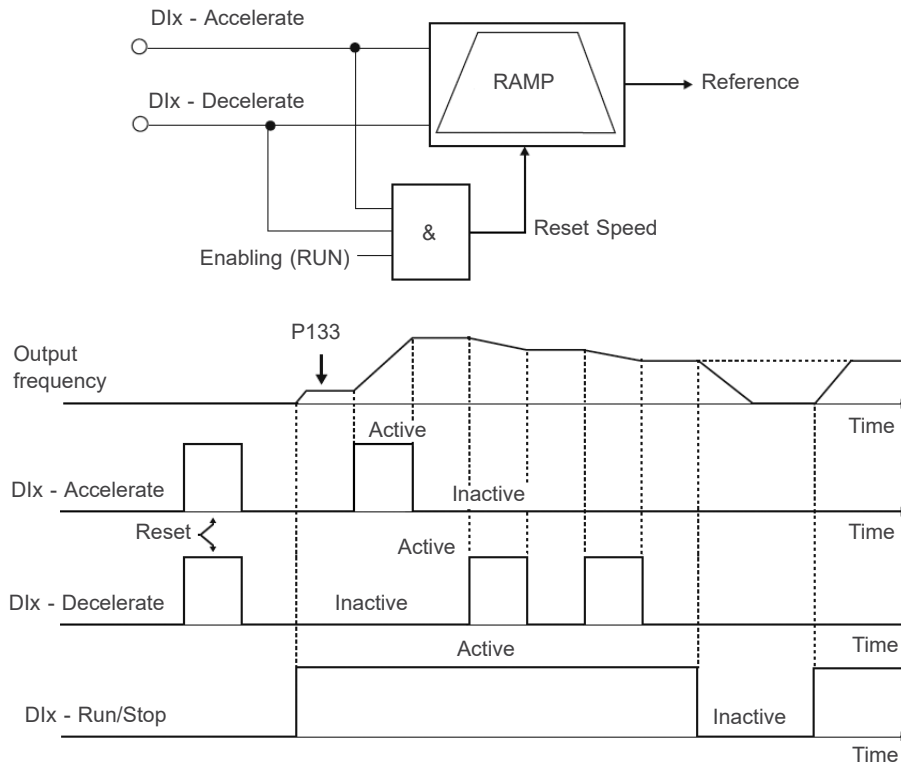

Figure 9.13: Example of the Electronic Potentiometer (E.P.) function

j) MULTISPEED

The Multispeed reference, as described in [Section 7.2 SPEED REFERENCE on page 7-6](#), enables, by means of the combination of up to three digital inputs, the selection of one from eight reference levels predefined in parameters P124 to P131.

For further details, refer to [Chapter 7 COMMAND AND REFERENCES on page 7-1](#).

k) 2nd RAMPA

If Dlx is inactive, the inverter uses the default ramp by P100 and P101, otherwise, it will use the 2nd Ramp by P102 and P103 ([Figure 9.14 on page 9-20](#)).

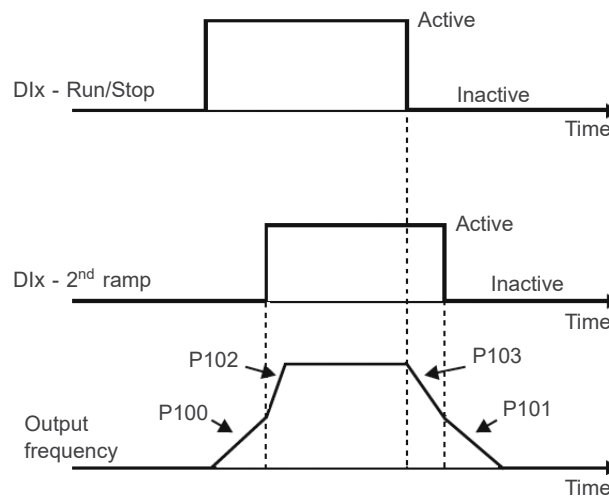

Figure 9.14: Example of the 2nd Ramp function

l) NO EXTERNAL ALARM

If Dlx is inactive, the inverter will activate the external alarm A090.

m) NO EXTERNAL FAULT

If DIx is inactive, the inverter will activate the external fault F091. In this case, the PWM pulses are disabled immediately.

n) FAULT RESET

Once the inverter is with the fault state active, and the fault origin condition is no longer active. The reset of the fault state will occur when the DIx set for this function is active.

o) DISABLE FLYING START

It allows the DIx, when active, to disable the action of the Flying Start function preset in parameter P320 = 1 or 2. When the DIx is inactive, the Flying Start function operates normally again. Refer to [Section 8.1 COMMON FUNCTIONS on page 8-1](#) for more information.

p) LOCK PROG

When the DIx input is active, parameters cannot be changed, no matter the values set in P000 and P200. When the DIx input is Inactive, the modification of parameters will depend on the values set in P000 and P200.

q) LOAD USER 1

This function allows the selection of the memory of User 1, a process similar to P0204 = 7, with the difference that the user is loaded from a transition in the DIx programmed for this function.

r) LOAD USER 2

This function allows the selection of the memory of User 2, a process similar to P0204 = 8, with the difference that the user is loaded from a transition in the DIx programmed for this function.

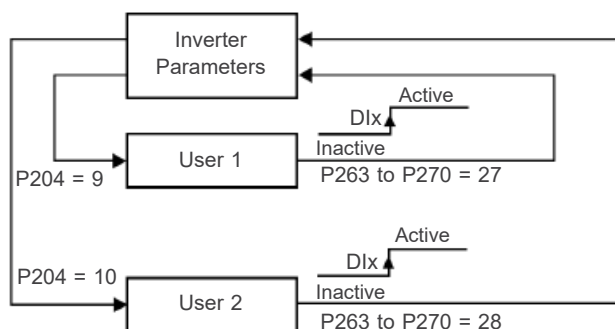

Figure 9.15: Block diagram of functions loads user 1 and user 2

s) ACCELERATE E.P. - TURN ON / DECELERATE E.P. - TURN OFF

It consists of the Electronic Potentiometer function with capacity to enable the inverter by means of a pulse at the start, and a pulse for the stop when the output speed is minimum (P133) ([Figure 9.16 on page 9-22](#)).

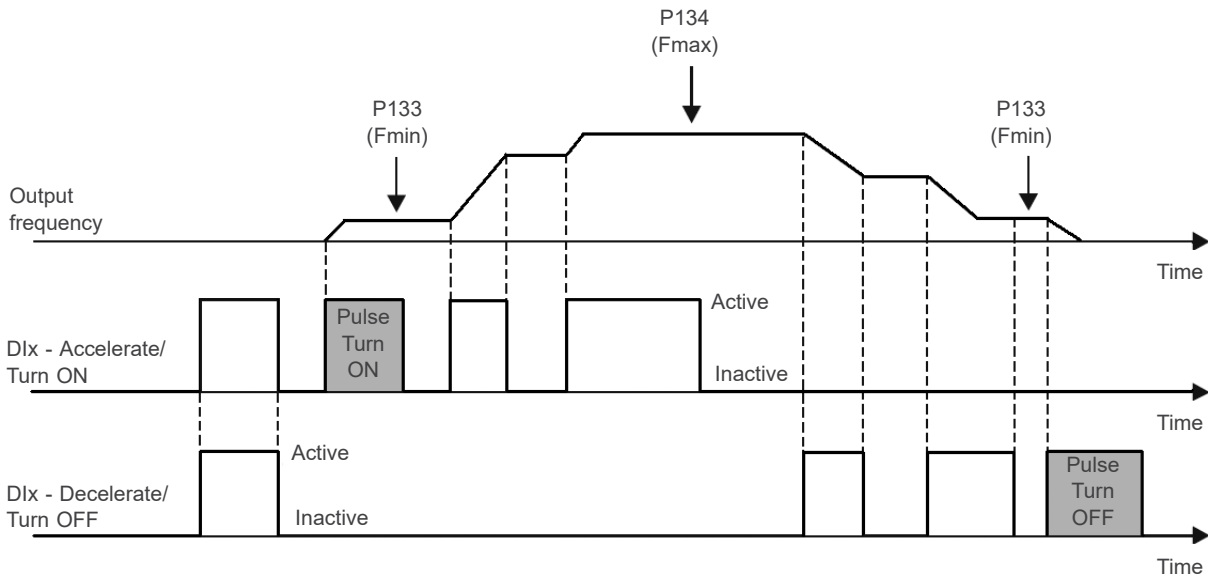

Figure 9.16: Example of the Accelerate Turn ON / Decelerate Turn OFF

t) STOP

Only on pulse in the DlX disables the inverter (Figure 9.17 on page 9-22).

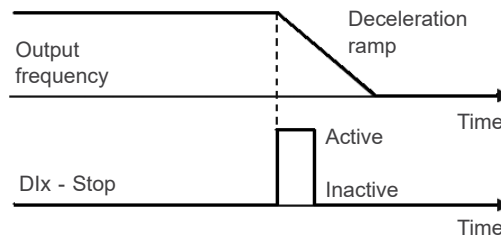

Figure 9.17: Example the stop function

u) STOP (INACTIVE PULSE)

Only one inactive pulse in the DlX disables the inverter (Figure 9.18 on page 9-22).

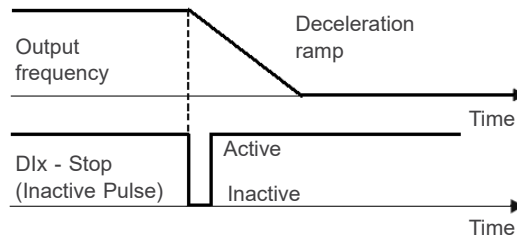

Figure 9.18: Example of the Stop function with inactive pulse

v) RUN/STOP, FORWARD AND REVERSE COMMAND WITH ON-LOCK ON POWER-UP

These features are identical to those in the [Items a\) RUN/STOP on page 9-17](#) and [d\) FORWARD/REVERSE COMMAND on page 9-18](#). The term 'ON-LOCK' refers to the status of the DI when the drive is powered up. If the drive is powered up with the DIs already enabled, these DI commands will have no effect. To unlock them, the DlX must be disabled and then enabled again, i.e. activated by the rising edge. This is an interlock for the DI command during power-up.

9.7 INPUT FOR INFRARED RECEIVER

The IOADR accessory uses an infrared remote control to control the inverter. The RC-5 protocol (Philips) was used for the communication of the control with the accessory. The information on the control/selection of remote control is available in the parameters below.

P840 - IR Control Command

Adjustable Range:	0 to FFFF (hexa)	Factory Setting:
Properties:	ro	

Description:

It indicates if the frequency inverter is receiving any valid command from the infrared control. The use of the remote control depends on the logic implanted on the LADDER of the WPS software via system markers (bits). For further details, refer to the help menu of the WPS software.

P841 - IR Controle Selection

Adjustable Range:	0 = Without Display 1 = With Display	Factory Setting: 0
Properties:	cfg	

Description:

It allows select which infrared remote control will be used. For further details, refer to the installation, configuration, and operation guide of the I/O IOADR expansion module .

9.8 ENCODER INPUT

The IOAENC expansion module makes it possible to connect an incremental encoder to the frequency inverter. The speed (RPM) and pulse count are available to user by parameters.

Below is a detailed description of the parameters for the encoder input.

P038 - Encoder Speed

Adjustable Range:	-9999 to 9999 rpm	Factory Setting:
Properties:	ro	

Description:

It indicates the instant speed of the encoder in revolutions per minute (RPM); the measurement is not filtered and it is updated every 6 ms.

P039 - Encoder Pulses Count

Adjustable Range:	0 to 9999	Factory Setting:
Properties:	ro	

Description:

It indicates the number of pulses counted by encoder in quadrature. The count can be incremented from 0 to 9999 (clockwise) or decremented from 9999 to 0 (counterclockwise).

P191 - Clear Enc. Pulse Counter

Adjustable	0 = No	Factory	0
Range:	1 = Yes	Setting:	
Properties:	cfg		

Description:

It allows to reset the pulse counter to synchronize the counter aiming to synchronize the minimum or maximum count at the parameter P039 - Encoder Pulse Counter, with the application limits (limit switches).

This parameter starts with zero value at the frequency inverter power-on. When adjusted to one (P191 = 1) the function is activated. After the function turn on, the parameter P039 is cleared or setted up with maximum count value (9999), according with the direction of rotation.

At the end of P039 clearing, the value of parameter, P191, returns to zero, allowing perform the process again, if necessary.

P358 - Encoder Fault Config.

Adjustable	0 = Inactive	Factory	3
Range:	1 = F067 ON 2 = F079 ON 3 = F067 and F079 ON	Setting:	
Properties:	cfg		

Description:

It allows individually disabling the encoder related fault detection: a) F067 - Inverted Encoder/Motor Wiring and b) F079 - Encoder Signal Fault. The verification by software of faults F067 and F079 will remain disabled when P358 = 0.

P405 - Encoder Pulses Number

Adjustable	32 to 9999	Factory	1024
Range:		Setting:	
Properties:	cfg		

Description:

It defines the number of pulses per revolution (ppr) of the incremental encoder. This parameter influences the indication of the speed parameters (P038) and pulse counter (P039) of the encoder.

For further details, refer to the installation, configuration and operation guide of the expansion module.

**NOTE!**

The encoder input is not used to motor vector control, and must be applied when there is no requirement to high performance.

9.9 DIGITAL OUTPUTS

The frequency inverter can activate relay digital outputs available at product and/or accessory. The parameter configuration of the digital outputs behaves as described in detail below.

P013 - DO4 to DO1 Status

Adjustable	0 to F (hexa)	Factory
Range:	Bit 0 = DO1	Setting:
	Bit 1 = DO2	
	Bit 2 = DO3	
	Bit 3 = DO4	
Properties:	ro	

Description:

It indicates digital outputs status.

The P013 value is indicated in hexadecimal, where each bit of the number indicates the status of a digital output, that is, if Bit0 is "0", DO1 is inactive; if Bit0 is "1", DO1 is active.

**NOTE!**

Parameter P013 requires the user to know the conversion between binary and hexadecimal numerical system.

P275 - DO1 Function**P276 - DO2 Function****P277 - DO3 Function**

P278 - DO4 Function

Adjustable	0 = Not Used	Factory	P275 = 13
Range:	1 = $F^* \geq F_x$	Setting:	P276 = 0
	2 = $F \geq F_x$		P277 = 0
	3 = $F \leq F_x$		P278 = 0
	4 = $F = F^*$		
	5 = Not Used		
	6 = $I_s > I_x$		
	7 = $I_s < I_x$		
	8 = Torque > T_x		
	9 = Torque < T_x		
	10 = Remote		
	11 = Run		
	12 = Ready		
	13 = No Fault		
	14 = No F070		
	15 = Not Used		
	16 = No F021/F022		
	17 = Not Used		
	18 = No F072		
	19 = 4-20 mA OK		
	20 = P695 Value		
	21 = Forward		
	22 to 23 = Not Used		
	24 = Ride-Through		
	25 = Pre-Charge OK		
	26 = Fault		
	27 = Not Used		
	28 = SoftPLC		
	29 to 34 = Not Used		
	35 = No Alarm		
	36 = Without fault and alarm		
	37 = Application Function 1		
	38 = Application Function 2		
	39 = Application Function 3		
	40 = Application Function 4		
	41 = Application Function 5		
	42 = Application Function 6		
	43 = Application Function 7		
	44 = Application Function 8		
	45 = Fire Mode ON		
	46 = Low Level of Process Variable		
	47 = High Level of Process Variable		

Description:

It configures the DOx digital output function, as per [Table 9.6 on page 9-27](#).

Table 9.6: Digital Output Functions

Value	Function	Description
0	Not Used	It deactivates the digital output
1	$F^* \geq F_x$	Active when the frequency reference F^* (P001) is greater or equal the F_x (P281)
2	$F \geq F_x$	Active when the Output Frequency F (P002) is greater or equal the F_x (P281)
3	$F < F_x$	Active when the Output Frequency F (P002) is smaller or equal the (P281)
4	$F = F^*$	Active if the Output Frequency F (P002) is equal to the reference F^* (P001) (ramp end)
5	Not Used	It deactivates the digital output
6	$I_s > I_x$	Active if the output current I_s (P003) $>$ I_x (P290)
7	$I_s < I_x$	Active if the output current I_s (P003) $<$ I_x (P290)
8	Torque $>$ T_x	Active if the motor torque T (P009) $>$ T_x (P293)
9	Torque $<$ T_x	Active if the motor torque T (P009) $<$ T_x (P293)
10	Remote	Active if the command is in the remote situation (REM)
11	Run	Active if the motor is running (active output PWM pulses)
12	Ready	Active if the inverter is ready for enabling
13	Without fault	Active if the inverter has no faults
14	Without F070	Active if the inverter has no overcurrent fault (F070)
15	Not Used	It deactivates the digital output
16	Without F021/F022	Active if the inverter has no overvoltage or undervoltage fault (F022 or F021)
17	Not Used	It deactivates the digital output
18	Without F072	Active if the inverter has no motor overload fault (F072)
19	4-20 mA OK	Active if Alx setting is 4 to 20 mA (P233 = 1 or 3) and $Alx > 2$ mA
20	Value of P695	Status of the bits 0 to 4 of P695 activate digital outputs DO1 to DO5, respectively
21	Forward	Active if the inverter direction of rotation is forward
22 to 23	Not Used	It deactivates the digital output
24	Ride-Through	It activates if the inverter is running a function Ride-Through
25	Pre-Charge OK	Active if the pre-charge relay of the DC link capacitors was already activated
26	With fault	Active if the inverter has a fault
27	Not Used	It deactivates the digital output
28	SoftPLC	It activates the output DOx according to the SoftPLC memory area. Check the SoftPLC user manual
29 to 34	Not Used	It deactivates the digital output
35	Without Alarm	Active when the inverter has no alarms
36	Without fault and alarm	Active when the inverter has neither alarms nor faults
37	Application Function 1	If activates the output DOx according to the application of SoftPLC
38	Application Function 2	If activates the output DOx according to the application of SoftPLC
39	Application Function 3	If activates the output DOx according to the application of SoftPLC
40	Application Function 4	If activates the output DOx according to the application of SoftPLC
41	Application Function 5	If activates the output DOx according to the application of SoftPLC
42	Application Function 6	If activates the output DOx according to the application of SoftPLC
43	Application Function 7	If activates the output DOx according to the application of SoftPLC
44	Application Function 8	If activates the output DOx according to the application of SoftPLC
45	Fire Mode	Activates DOx output when Fire Mode is enabled
46	Process Control	Process Variable Low Level (A760/F761) (For P903 = 1) ^(*)
47	Process Control	Process Variable High Level (A762/F763) (For P903 = 1) ^(*)

(*) For further details refer the [Chapter 13 SOFTPLC on page 13-1](#).

P281 - Fx Frequency

Adjustable Range: 0.0 to 400.0 Hz

Factory Setting: 3.0 Hz

Description:

It defines the actuation level on the output frequency signal F_x and on the ramp input F^* of the digital relay output.

In this way, the relay commutation levels are “P281 + P282” and “P281 - P282”.

P282 - Fx Hysteresis

Adjustable Range:	0.0 to 15.0 Hz	Factory Setting:	0.5 Hz
--------------------------	----------------	-------------------------	--------

Description:

It defines the hysteresis on the output frequency signal Fx and on the ramp input F* of the digital relay output. In this way, the relay commutation levels are "P281 + P282" and "P281 - P282".

P290 - Ix Current

Adjustable Range:	0.0 to 100.0 A	Factory Setting:	1.0 x I _{nom}
--------------------------	----------------	-------------------------	------------------------

Description:

It defines the current level to activate the relay output in the $I_s > I_x$ (6) and $I_s < I_x$ (7) functions. The actuation occurs on a hysteresis with upper in P290 and lower level in: $P290 - 0.05 \times P295$, that is, the equivalent value in Amperes for 5 % of P295 below P290.

P293 - Tx Torque

Adjustable Range:	0 to 200 %	Factory Setting:	100 %
--------------------------	------------	-------------------------	-------

Description:

It defines the torque percentage level to activate the relay output in the Torque > Tx (8) and Torque < Tx (9) functions. The actuation occurs on a hysteresis with upper level in P293 and lower level in: $P293 - 5 \%$. This percentage value is related to the motor rated torque matched to the inverter power, and it is expressed in percentage of the motor rated current ($P401 = 100 \%$).

P695 - DOx Value

Adjustable Range:	0 to F (hexa) Bit 0 = DO1 Bit 1 = DO2 Bit 2 = DO3 Bit 3 = DO4	Factory Setting:	
Properties:	ro		

Description:

It provides access for monitoring and controlling the inverter by using the communication interfaces. For a detailed description, refer to the user manual of the communication network, available for download on the website: www.weg.net.

10 FAULTS AND ALARMS

The problem detection structure in the inverter is based on the fault and alarm indication.

In case of fault, the locking the IGBTs and motor stop by inertia will occur.

The alarm works as a warning for the user of critical operating conditions and that may cause a fault if the situation is not corrected.

10.1 FAULT HISTORY

The inverter is able to store a set of data on the last three faults occurred, such as: fault number, current (P003), DC link voltage (P004), output frequency (P005), power module temperature (P030).

P048 - Present Alarm

P049 - Present Fault

Adjustable Range: 0 to 999

Factory Setting:

Properties: ro

Description:

It indicates the alarm (P048) or the fault (P049) number that may be present in the inverter.

P050 - Last Fault

P060 - Second Fault

P070 - Third Fault

Adjustable Range: 0 to 999

Factory Setting:

Properties: ro

Description:

It indicates the number of the occurred fault.

P051 - Current At Last Fault

Adjustable Range: 0.0 to 100.0 A

Factory Setting:

Properties: ro

Description:

It indicates the output current at the moment of the last occurred fault.

P052 - DC Link At Last Fault

Adjustable Range: 0 to 828 V

Factory Setting:

Properties: ro

FAULTS AND ALARMS

Description:

It indicates the DC link voltage at the moment of the last occurred fault.

P053 - Frequency At Last Fault

Adjustable Range: 0.0 to 400.0 Hz

Factory Setting:

Properties: ro

Description:

It indicates the output frequency at the moment of the last occurred fault.

P054 - Temperature Last Fault

Adjustable Range: 0.0 to 200.0 °C

Factory Setting:

Properties: ro

Description:

It indicates the IGBTs temperature at the moment of the last occurred fault.

P080 - Last Fault on Fire Mode

P081 - Second Fault on Fire Mode

P082 - Third Fault on Fire Mode

Adjustable Range: 0 to 999

Factory Setting:

Properties: ro

Description:

It indicates the last three faults that occurred on the inverter while the Fire Mode was active.

10.2 FAULT CONTROL

The parameters related to the control of the motor protections of operation and the inverter are in this group.

P340 - Auto-Reset Time

Adjustable Range: 0 to 255 s

Factory Setting: 0 s

Description:

It defines the interval after a fault (except F067: Incorrect Encoder/Motor Wiring) to activate the inverter autoreset. If the value of P340 is zero the fault autoreset function is disabled.



NOTE!

The function auto-reset is locked if the same fault occurs three times in a row within 30 seconds after the reset.

10.3 PROTECTIONS

This section contains information on the internal protections of the inverters and the motors. Refer to the user's manual for further information.

10.3.1 Inverter

The inverter has several levels of internal protection. Among them, we can point out:

10.3.1.1 DC Link Voltage Supervision

The DC link voltage is constantly compared to the maximum and minimum values according to the inverter power supply, as shown in [Table 10.1 on page 10-3](#).

Table 10.1: Levels of performance monitoring of the DC link voltage

Supply	Level F021	Level F022
110 to 127 Vac (P296 = 1)	200 Vdc	460 Vdc
200 to 240 Vac (P296 = 2)	200 Vdc	410 Vdc
380 Vac (P296 = 4)	385 Vdc	800 Vdc
400 to 415 Vac (P296 = 5)	405 Vdc	800 Vdc
440 to 460 Vac (P296 = 6)	446 Vdc	800 Vdc
480 Vac (P296 = 7)	486 Vdc	800 Vdc

10.3.1.2 Temperature control

The temperature of the power module is read via internal temperature sensor and displayed in parameter P030 (more information on [Chapter 11 READ on page 11-1](#)). The temperature controlled by a fan according to parameter P352.

P352 - Fan Control Config.

Adjustable	0 = OFF	Factory	2
Range:	1 = ON	Setting:	
	2 = CT		
Properties:	cfg		

Description:

It allows control the heatsink fan.

The options available to set this parameter are described in [Table 10.2 on page 10-3](#).

Table 10.2: Option of parameter P352

P352	Action
0 = OFF	Fan off
1 = ON	Fan on
2 = CT	Fan is controlled via software

10.3.2 Motor

The inverter has a function to protect the motor from overtemperature by indicating fault F078. The motor must have a triple PTC type temperature sensor. The sensor can be read through the analog inputs.

For the reading of the PTC, it is necessary to configure it for current input and select the option "4 = PTC" in P231 or P236. Connect the PTC between the supply +10 Vdc and the analog input.

The analog input reads the PTC resistance and compares it to the limits for the fault. When those values are exceeded, fault F078 is indicated. As shown in [Table 10.3 on page 10-4](#).

FAULTS AND ALARMS



ATTENTION!

The PTC must have reinforced insulation of the live parts of the motor and other installations.

Table 10.3: Actuation levels of fault F078

PTC Resistance	Alx	Overtemperature
$R_{PTC} < 50 \Omega$	$V_{in} > 9.1 V$	F078
$50 \Omega < R_{PTC} < 3.9 k\Omega$	$9.1 V > V_{in} > 1.3 V$	Standard
$R_{PTC} > 3.9 k\Omega$	$V_{in} < 1.3 V$	F078



NOTE!

For this function to work properly, it is important to keep the gain(s) and offset(s) of the analog inputs at the factory setting values.

The [Figure 10.1 on page 10-4](#) shows the connection of the PTC to the inverter terminals via analog input.

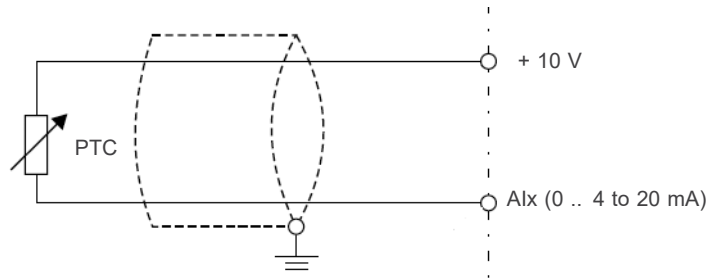

Figure 10.1: Connection of the PTC to the frequency inverter

P037 - Motor Overload Ixt

Adjustable Range:	0.0 to 100.0 %	Factory Setting:
Properties:	ro	

Description:

It indicates the present motor overload percentage or overload intergrator level. When this parameter reaches 6.3 % the inverter will indicate the motor overload alarm (A046). Or when this parameter reaches 100.0 % the "Motor Overload" fault (F072) will occur (F072).

[Figure 10.2 on page 10-5](#) shows the actuation time of the overload as a function of the output current (P003) normalized in relation to the overload current (P156, P157 or P158).

For example, for a constant ratio with 150 % of overload, Fault F072 occurs in 60 seconds. On the other hand, for output current values below P156, P157 or P158 according to the output frequency, fault F0072 does not occur. For ratio values above 150 % the fault actuation time is below 60 s.

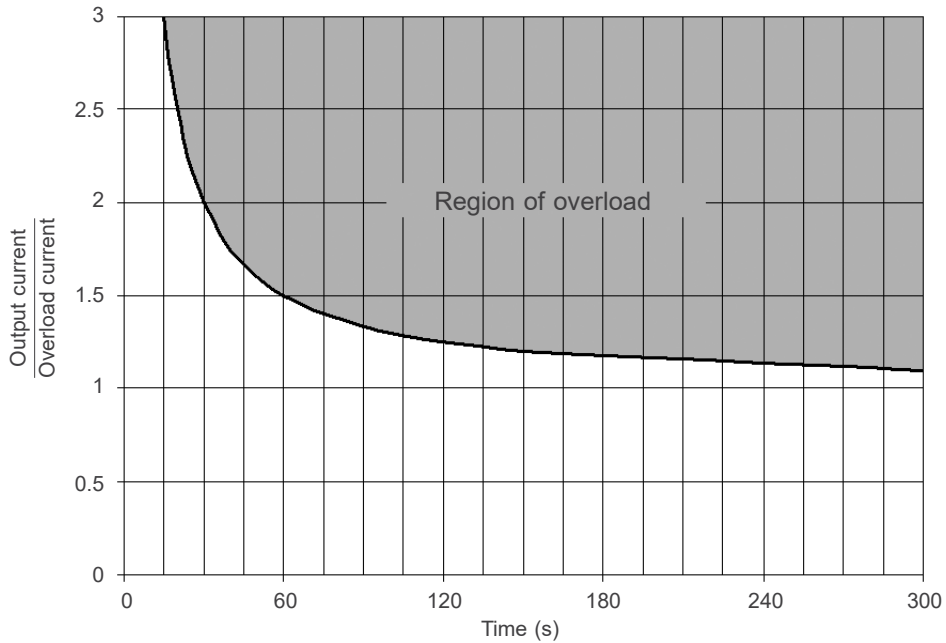

Figure 10.2: Actuation of the motor overload



NOTE!

In order to ensure greater protection in case of de-energization of the inverter, this function keeps the information regarding the motor thermal image in a non-volatile memory area of the inverter. Thus, after the inverter energization, the function will use the saved value of the thermal image to execute a new overload assessment.

P156 - Rated Speed Overload Current

P157 - Overl.Curr.50 % Speed

P158 - Overl.Curr.20 % Speed

Adjustable Range:	0.1 to 2.0 x I _{nom}	Factory Setting:	1.2 x I _{nom}
--------------------------	-------------------------------	-------------------------	------------------------

Description:

It defines the motor overload current (I_{xt} - F072). The motor overload current is the current value (P156, P157 or P158) based on which the inverter will understand that the motor is operating in overload.

For self-ventilated motors, the overload current depends on the speed at which the motor is spinning. Therefore, for speeds below 20 % of the rated speed, the overload current is P158, while for speeds between 20 % and 50 % the overload current is P157, and above 50 % it is P156.

The greater the difference between the motor current and the overload current (P156, P157 or P158) the faster the actuation of fault F072.

It is recommended that parameter P156 (motor overload current at rated speed) be set at a value 10 % above the used motor rated current (P401).

In order to deactivate the motor overload function, just set parameter P156 to P158 to values equal to or above twice the inverter rated current P295.

11 READ

It is important to point out that all the parameters of this group can only be viewed on the HMI display, and cannot be changed by the user.

P001 - Speed Reference

Adjustable Range:	0 to 9999	Factory Setting:
Properties:	ro	

Description:

Presents, regardless the origin source, the speed reference value in the unit and scale defined for the reference by P208, P209 and P210. The full scale and reference unit in the factory default are 60.0 Hz for P204 = 5 and 50.0 Hz for P204 = 6.

P002 - Output Speed (Motor)

Adjustable Range:	0 to 9999	Factory Setting:
Properties:	ro	

Description:

It indicates the speed imposed to the inverter output at the same scale defined for P001. In this parameter, the compensations made to the output frequency are not shown. In order to see them, use P005.

This is an exception to the other reading parameters. It can be used to modify the speed reference (P121) when P221 or P222 = 0.

P003 - Motor Current

Adjustable Range:	0.0 to 100.0 A	Factory Setting:
Properties:	ro	

Description:

It indicates the inverter output current in amperes RMS (Arms).

P004 - DC Link Voltage

Adjustable Range:	0 to 828 V	Factory Setting:
Properties:	ro	

Description:

It indicates the DC link direct current voltage in (V).

P005 - Output Frequency (Motor)

Adjustable Range:	0.0 to 400.0 Hz	Factory Setting:
Properties:	ro	

READ

Description:

It indicates the real frequency instantly applied to the motor in Hertz (Hz).









P006 - Inverter Status

Adjustable Range:	0 = Ready 1 = Run 2 = Undervoltage 3 = Fault 4 = Self-Tuning 5 = Configuration 6 = DC Braking 7 = Reserved 8 = Fire Mode	Factory Setting:
Properties:	ro	

Description:

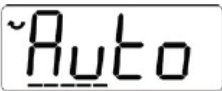
It indicates one of the possible inverter status. In [Table 11.1 on page 11-3](#) contains the description of each state, as well as the indication on the HMI.

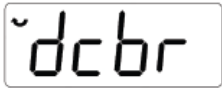
Table 11.1: Inverter status - P006

P006	Status	HMI	Description
0	Ready		Indicates the inverter is ready to be enabled
1	Run		Indicates the inverter is enabled
2	Sub		Indicates the voltage in the inverter is too low for operation (undervoltage), and will not accept the enabling command
3	Fault		Indicates the inverter is in the fault status. The fault code will flash
4	Self-tuning		Indicates the inverter is executing the Self-Tuning routine
5	Configuration		Indicates the inverter has incompatible parameter programming. After pressing the P key, it will keep showing an arrow until the incorrect setting is corrected, as shown in the figure. The situations of CONFIG status are shown in the Table 11.3 on page 11-6
6	DC Braking		Indicates the inverter is applying DC Braking during motor start and/or motor stop
7	Reserved	-	-
8	Fire Mode		Indicates that the inverter is in Fire Mode. After pressing the P key, letter "A" will continue to flash indicating the state

P007 - Output Voltage

Adjustable Range: 0 to 480 V

Factory Setting:

Properties: ro

Description:

It indicates the line voltage in inverter output, in Volts (V).

READ

P009 - Motor Torque

Adjustable Range:	-200.0 to 200.0 %	Factory Setting:
Properties:	ro	

Description:

It indicates the torque developed by the motor in relation to the rated torque.

P030 - Module Temperature

Adjustable Range:	-200.0 to 200.0 °C	Factory Setting:
Properties:	ro	

Description:

It indicates the temperature of the power module in degrees Celsius (°C). This value is constantly compared to the overtemperature fault and alarm tripping value of the power module F051 and A050, according to [Table 11.2 on page 11-4](#).

Table 11.2: Overtemperature actuation levels of the power module

Line	Frame Size	Level A050	Level F051	Fan Turn On Level	Fan Turn Off Level
200 V	A	90 °C (194 °F)	100 °C (212 °F)	70 °C (158 °F)	60 °C (140°F)
200 V	B	116 °C (241 °F)	126 °C (258 °F)	90 °C (194 °F)	80 °C (176°F)
400 V	A, B and C	100 °C (212 °F)	110 °C (230 °F)	60 °C (140 °F)	50 °C (122 °F)

In addition to the indication of alarm A050, the overtemperature protection gradually reduces the switching frequency to 2.5 kHz. This overtemperature protection characteristic can be disabled in the control configuration parameter P397.



NOTE!

The default setting of P397 meets most application needs of the inverter. Therefore, avoid modifying its content without knowing the related consequences. If you are not sure, contact WEG Technical Assistance before changing P397.

P042 - Running Time

Adjustable Range:	0.0 to 999.9	Factory Setting:
Properties:	ro	

Description:

It indicates the total time the inverter remained in operation. Each P042 = 999.9 h, P043 is incremented by 1, and P042 is reset again.

P043 - Running Time(h/1000)

Adjustable Range:	0 to 9999	Factory Setting:
Properties:	ro	

Description:

It indicates que total time the inverter remained in operation. Each P042 = 999.9 h, P043 is incremented by 1, and P042 is reset again.

P045 - Fan Enabled Time

Adjustable Range: 0 to FFFF (hexa)

Factory Setting:

Properties: ro

Description:

It indicates the total number of hours that the heatsink fan remained connected. This value is kept even when the inverter is disconnected.

P047 - CONF Status

Adjustable Range: 0 to 33

Factory Setting:

Properties: ro

Description:

It indicates the source situation of the CONFIG mode. The [Table 11.3 on page 11-6](#) describes the CONFIG status.

Table 11.3: Situations for CONFIG status

P047	Condition
0	Out of CONFIG status. The HMI and parameters P006 and P680 must not indicate Conf
1	Two or more Dlx (P263...P270) programmed for (4 = Forward Run)
2	Two or more Dlx (P263...P270) programmed for (5 = Reverse Run)
3	Two or more Dlx (P263...P270) programmed for (6 = Start)
4	Two or more Dlx (P263...P270) programmed for (7 = Stop)
5	Two or more Dlx (P263...P270) programmed for (8 = Direction of Rotation)
6	Two or more Dlx (P263...P270) programmed for (9 = LOC/REM)
7	Two or more Dlx (P263...P270) programmed for (11 = Accelerate E.P.)
8	Two or more Dlx (P263...P270) programmed for (12 = Decelerate E.P.)
9	Two or more Dlx (P263...P270) programmed for (14 = 2 nd Ramp)
10	Reserved
11	Two or more Dlx (P263...P270) programmed for (24 = Disable Flying Start)
12	Two or more Dlx (P263...P270) programmed for (26 = Programming Off)
13	Reserved
14	Reserved
15	Dlx (P263...P270) programmed for (4 = Forward Run) without Dlx (P263...P270) programmed for (5 = Reverse Run) or the opposite
16	Dlx (P263...P270) programmed for (6 = Start) without Dlx (P263...P270) programmed for (7 = Stop) or the opposite
17	P221 or P222 programmed for (8 = Multispeed) without Dlx (P263...P270) programmed for (13 = Multispeed) or the opposite
18	P221 or P222 programmed for (7 = E.P.) without Dlx (P263...P270) programmed for (11 = Accelerate E.P) or the opposite
19	P224 programmed for (1 = Dlx) OR P227 programmed for (1 = Dlx) without Dlx (P263...P270) programmed for (1 = Run/Stop) AND without Dlx (P263...P270) programmed for (2 = General Enable) AND without Dlx (P263...P270) programmed for (3 = Quick Stop) AND without Dlx (P263...P270) programmed for (4 = Forward Run) AND without Dlx (P263...P270) programmed for (6 = Start)
20	Reserved
21	P221 or P222 programmed for (8 = Multispeed) with DI1 (P263) AND DI2 (P264) OR DI1 (P263) AND DI5 (P267) OR DI1 (P263) AND DI6 (P268) OR DI2 (P264) AND DI5 (P267) OR DI2 (P264) AND DI6 (P268) OR DI5 (P267) AND DI6 (P268) programmed for (13 = Multispeed)
22	Minimum Frequency Reference (P133) greater than Maximum Frequency Reference (P134)
23 to 28	Reserved
29	Two or more Dlx (P263...270) programmed for (49 = Enable Fire Mode) OR two or more DOx (P275...P278) Programmed for (45 = Fire Mode ON) OR P580 programmed for 1, 2 or 4 (Fire Mode Enabled) without Dlx programmed for (49 = Enable Fire Mode) OR Dlx programmed for (49 = Enable Fire Mode) OR DOx programmed for (45 = Fire Mode ON) and P580 programmed for (0 = Fire Mode Disabled) or (3 = Reserved)
30 to 32	Reserved
33	Parameterization in conflict with DC Bus Compensation. Energy Saver active (P588 value other than zero), Controle VVW ativo (P202 = 5), Functions Ride-Through or Flying Start are enable (P320 value other than zero)

P680 - Logical Status

Adjustable Range:		Factory Setting:
	0 to FFFF (hexa)	
	Bit 0 = Reserved	
	Bit 1 = Run Command	
	Bit 2 = Fire Mode	
	Bit 3 to 4 = Reserved	
	Bit 5 = 2 nd Ramp	
	Bit 6 = Config. Mode	
	Bit 7 = Alarm	
	Bit 8 = Running	
	Bit 9 = Enabled	
	Bit 10 = Forward	
	Bit 11 = JOG	
	Bit 12 = Remote	
	Bit 13 = Subvoltage	
	Bit 14 = Reserved	
	Bit 15 = Fault	
Properties:	ro	

Description:

The inverter status word is unique for all the sources and can only be accessed for reading. It indicates all the relevant operating status and modes of the inverter. The function of each bit of P680 is described in [Table 11.4 on page 11-7](#).

Table 11.4: Status word P680

BIT	Function	Description
0	Reserved	-
1	Run Command	0: There was no Run command 1: There was Run command
2	Fire Mode	0: Fire Mode function inactive 1: Fire Mode function active
3 and 4	Reserved	-
5	2 nd Ramp	0: 1 st acceleration and deceleration ramp by P100 and P101 1: 2 nd acceleration and deceleration ramp by P102 and P103
6	Config. Status	0: inverter operating in normal conditions 1: inverter in configuration state. It indicates a special condition in which the inverter cannot be enabled, because it has parameterization incompatibility
7	Alarm	0: inverter is not in alarm state 1: inverter is in alarm state
8	Running	0: motor is stopped 1: inverter is running according to reference and command
9	Enabled	0: inverter is completely disabled 1: inverter is completely enabled and ready to turn the motor
10	Forward	0: motor is running in the reverser direction 1: motor is running in the forward direction
11	JOG	0: JOG function inactive 1: JOG function active
12	Remote	0: inverter in Local mode 1: inverter in Remote mode
13	Undervoltage	0: no undervoltage 1: with undervoltage
14	Reserved	-
15	Fault	0: inverter is not in fault state 1: some fault registered by the inverter

P681 - 13-Bit Speed

Adjustable Range:	0 to FFFF (hexa) [-32768 to 32767]	Factory Setting:
Properties:	ro	

Description:

It defines the 13-bit speed reference. The 13-bit Frequency Reference is a scale based on the motor rated speed (P402) or on the motor rated frequency (P403). In the inverter, parameter P403 is taken as the base to determine the frequency reference.

Thus, the 13-bit frequency value has a range of 16 bits with signal, that is, -32768 to 32767; however, the rated frequency in P403 is equivalent to the value 8192. Therefore, the maximum value in the range 32767 is equivalent to four times P403:

READ

- P681 = 0000h (0 decimal) → motor speed = 0;
- P681 = 2000h (8192 decimal) → motor speed = rated frequency.

P690 - Logic State 2

Adjustable Range:	0 to FFFF (hexa) Bit 0 to 1 = Reserved Bit 2 = DC Link Voltage Extended Bit 3 = Energy Saver Bit 4 = Fs Reduction Bit 5 = Reserved Bit 6 = Deceleration Ramp Bit 7 = Acceleration Ramp Bit 8 = Freeze Ramp Bit 9 = Setpoint Ok Bit 10 = DC Link Regulation Bit 11 = 50 Hz Config Bit 12 = Ride-Through Bit 13 = Flying Start Bit 14 = DC Braking Bit 15 = PWM pulse	Factory Setting:
Properties:	ro	

Description:

It indicates signaling status for functions implemented in the inverter. The function of each bit of P0690 is described in [Table 11.5 on page 11-9](#).

Table 11.5: Status word P690

BIT	Function	Description
0 to 1	Reserved	-
2	DC Link Voltage Extended	0: DC Link Voltage Extended inactive 1: DC Link Voltage Extended active
3	Energy Saving	0: Energy saving inactive 1: Energy saving active
4	Fs Reduction	0: Output frequency reduction inactive 1: Output frequency reduction active
5	Reserved	-
6	Deceleration Ramp	0: No deceleration 1: Inverter accelerating
7	Acceleration Ramp	0: No deceleration 1: Inverter accelerating
8	Frozen Ramp	0: Ramp operating in normal conditions 1: The path of the ramp is frozen by some command source or internal function
9	Setpoint OK	0: Output frequency has not reached reference yet 1: Output frequency reached reference
10	DC Link Regulation	0: DC Link Regulation inactive 1: DC Link Regulation active
11	50 Hz Config	0: Factory default loaded in 60 Hz (P204 = 5) 1: Factory default loaded in 50 Hz (P204 = 6)
12	Ride-Through	0: No execution of Ride-Through 1: Executing Ride-Through
13	Flying Start	0: No execution of Flying Start 1: Executing Flying Start
14	DC Braking	0: DC breaking inactive 1: DC breaking active
15	PWM Pulses	0: PWM voltage pulses in the output disabled 1: PWM voltage pulses in the output enabled

12 COMMUNICATION

In order to exchange information via communication network, the frequency inverter features several standardized communication protocols, such as Modbus (RTU and TCP), CANopen, DeviceNet, Profibus DP and Ethernet IP.

For further details referring to the inverter configuration to operate in those protocols, refer to the inverter user's manual for communication with the desired network.

12.1 COMMANDS AND COMMUNICATION STATUS

See below the parameters related to the states and commands through the communication networks available for the frequency inverter.

P313 - Action for Communic. Error

Adjustable Range:	0 = Inactive 1 = Ramp Stop 2 = General Disable 3 = Go to LOC 4 = LOC Keep Enab. 5 = Cause Fault	Factory Setting: 1
--------------------------	--	---------------------------

Description:

It allows the selection of the action to be executed by the device, if it is controlled via network and a communication error is detected.

The following events are considered communication errors:

- A128 alarm/F228 fault: Serial communication timeout.

The actions described in this parameter are executed by means of the automatic writing of the selected actions in the respective bits of the interface control words. Therefore, in order that the commands are effective, it is necessary that the device be programmed to be controlled via the used network interface (with exception of option "Causes a Fault", which blocks the equipment even if it is not controlled by network). This programming is achieved by means of parameters P220 to P228.

P682 - Serial/USB Control

P684 - CO/DN/DP/ETH Control

Adjustable Range:	0 to FFFF (hexa) Bit 0 = Ramp Enable Bit 1 = General Enable Bit 2 = Run Forward Bit 3 = JOG Enable Bit 4 = Remote Bit 5 = 2nd Ramp Bit 6 = Reserved Bit 7 = Fault Reset Bit 8 to 15 = Reserved	Factory Setting:
Properties:	ro	

Description:

It provides control to communication interfaces. The inverter control word for a certain source is accessible for reading and writing, but read only access is permitted for the other sources. The inverter has a common word

COMMUNICATION

for each interface, which is defined by the function of its bits separately as per [Table 12.1 on page 12-2](#). The value of P682 is indicated in hexadecimal.

Table 12.1: Status word P682/P684

BIT	Function	Description
0	Ramp Enable	0: stops the motor by deceleration ramp 1: spins the motor according to the acceleration ramp until reaching the speed reference value
1	General Enable	0: disables the inverter completely, interrupting the power supply to the motor 1: enables the inverter completely, allowing the operation of the motor
2	Run Forward	0: spins the motor in the opposite direction of the reference signal (reverse) 1: spins the motor in the direction of the reference signal (forward)
3	Enable JOG	0: disable JOG function 1: enable JOG function
4	Remote	0: inverter goes into Local mode 1: inverter goes into Remote mode
5	2nd Ramp	0: acceleration and deceleration ramp by P100 and P101 1: acceleration and deceleration ramp by P102 and P103
6	Reserved	-
7	Fault Reset	0: no function 1: if in fault state, reset the fault
8 to 15	Reserved	-

P683 - Serial/USB Speed Ref.

P685 - CO/DN/DP/ETH Speed Ref

Adjustable	0 to FFFF (hexa)	Factory
Range:	[-32768 to 32767]	Setting:
Properties:	ro	

Description:

It allows programming the motor speed reference via communication interfaces only. For other sources (HMI, etc.), it behaves as a read-only parameter.

To enable the use of the reference written in this parameter, the product must be programmed to use the speed reference via communication network. This is programming is done using parameters P221 and P222.

This word uses a 13-bit resolution with signal to represent the motor rated frequency (P403):

- P683 = 0000h (0 decimal) → speed reference = 0.
P683 = 2000h (8192 decimal) → speed reference = rated frequency (P403).
- P685 = 0000h (0 decimal) → speed reference = 0.
P685 = 2000h (8192 decimal) → speed reference = rated frequency (P403).

This parameter also accepts negative values to revert the motor speed direction. The reference speed direction, however, depends also on the control word - P682/P684 bit 2 setting:

- Bit 2 = 1 and P683/P685 > 0: reference for forward direction
- Bit 2 = 1 and P683/P685 < 0: reference for reverse direction
- Bit 2 = 0 and P683/P685 > 0: reference for reverse direction
- Bit 2 = 0 and P683/P685 < 0: reference for forward direction

12.2 SERIAL

See below the frequency inverter parameters that are directly related to the Modbus RTU communication.

P308 - Serial Address

Adjustable Range:	1 to 247	Factory Setting:	1
Properties:	cfg		

P310 - Serial Baud Rate

Adjustable Range:	0 = 9600 bits/s 1 = 19200 bits/s 2 = 38400 bits/s 3 = 57600 bits/s 4 = 76800 bits/s	Factory Setting:	1
Properties:	cfg		

P311 - Serial Bytes Config.

Adjustable Range:	0 = 8 bits, no, 1 1 = 8 bits, even, 1 2 = 8 bits, odd, 1 3 = 8 bits, no, 2 4 = 8 bits, even, 2 5 = 8 bits, odd, 2	Factory Setting:	1
Properties:	cfg		

P312 - Serial Protocol

Adjustable Range:	0 to 1 = Reserved 2 = Modbus RTU Slave 3 = BACnet 4 = Reserved 5 = ModBus RTU Master	Factory Setting:	2
Properties:	cfg		

P314 - Serial Watchdog

Adjustable Range:	0.0 to 999.0 s	Factory Setting:	0.0 s
Properties:	cfg		

P316 - Serial Interf. Status

Adjustable Range:	0 = Inactive 1 = Active 2 = Watchdog Error	Factory Setting:	
Properties:	ro		

COMMUNICATION

Description:

These parameters are used for configuration and operation of the serial interfaces. For a description detailed, refer to the Modbus RTU, user's manual, available for download on the website: www.weg.net.

12.3 BLUETOOTH

See below the parameters to configure and operate the Bluetooth interface. For the correct configuration of this interface, it is necessary to configure properly the parameters of the [Section 12.2 SERIAL on page 12-3](#).

P770 - Bluetooth Device Name

Adjustable Range:	0 to 9999	Factory Setting:	Serial Number of the Inverter
--------------------------	-----------	-------------------------	-------------------------------

Description:

It defines the bluetooth device with a friendly name on the network. This name is limited to the four digits available on the inverter display.

The default value of this parameter is the last four digits of the inverter serial number.



NOTE!

Parameter P770 is only available with the bluetooth accessory connected.

P771 - Bluetooth Password PIN

Adjustable Range:	0 to 9999	Factory Setting:	1234
--------------------------	-----------	-------------------------	------

Description:

It defines the bluetooth parity password. This password is limited to the four digits available on the inverter display. It is recommended that the user change this password.



NOTE!

Parameter P771 is only available with the bluetooth accessory connected.

12.4 BACNET

See below the parameters to configure and operate the BACnet communication. For detailed description, refer to the communication manual (User) according to the interface used. These manuals are available for download on the website: www.weg.net.

P760 - BACnet Dev Inst Hi

Adjustable Range:	0 to 419	Factory Setting:	0
--------------------------	----------	-------------------------	---

P761 - BACnet Dev Inst Lo

Adjustable Range:	0 to 9999	Factory Setting:	0
--------------------------	-----------	-------------------------	---

P762 - Max Number of master

Adjustable Range:	0 to 127	Factory Setting:	127
--------------------------	----------	-------------------------	-----

P763 - MS/TP Max info Frame

Adjustable Range:	0 to FFFF (hexa)	Factory Setting:	1
--------------------------	------------------	-------------------------	---

P764 - I-AM Msg transmittion

Adjustable Range:	0 = Power Up 1 = Continuous	Factory Setting:	0
--------------------------	--------------------------------	-------------------------	---

P765 - Token RX Quantity

Adjustable Range:	0 to FFFF (hexa)	Factory Setting:	
Properties:	ro		

Description:

It provides access for configuration and operation of the BACnet interface. For a detailed description, refer to the BACnet communication manual, available for download on: www.weg.net.

12.5 CANOPEN AND DEVICENET

See below the parameters to configure and operate the CAN interface. For detailed description, refer to the communication manual (User) according to the interface used. These manuals are available for download on the website: www.weg.net.

P700 - CAN Protocol

Adjustable Range:	1 = CANopen 2 = DeviceNet	Factory Setting:	2
--------------------------	------------------------------	-------------------------	---

P701 - CAN Address

Adjustable Range:	0 to 127	Factory Setting:	63
--------------------------	----------	-------------------------	----

COMMUNICATION

P702 - CAN Baud Rate

Adjustable Range:	0 = 1 Mbps/Auto 1 = Reserved/Auto 2 = 500 Kbps 3 = 250 Kbps 4 = 125 Kbps 5 = 100 Kbps/Auto 6 = 50 Kbps/Auto 7 = 20 Kbps/Auto 8 = 10 Kbps/Auto	Factory Setting: 0
--------------------------	---	---------------------------

P703 - Bus Off Reset

Adjustable Range:	0 = Manual 1 = Automatic	Factory Setting: 1
--------------------------	-----------------------------	---------------------------

P705 - CAN Controller Status

Adjustable Range:	0 = Disabled 1 = Auto-baud 2 = CAN Active 3 = Warning 4 = Error Passive 5 = Bus Off 6 = No Bus Power	Factory Setting:
Properties:	ro	

P706 - RX CAN Telegrams

Adjustable Range:	0 to 9999	Factory Setting:
Properties:	ro	

P707 - TX CAN Telegrams

Adjustable Range:	0 to 9999	Factory Setting:
Properties:	ro	

P708 - Bus Off Counter

Adjustable Range:	0 to 9999	Factory Setting:
Properties:	ro	

P709 - CAN Lost Messages

Adjustable Range:	0 to 9999	Factory Setting:
Properties:	ro	

P710 - DeviceNet I/O instances

Adjustable Range:	0 = ODVA Basic 2W 1 = ODVA Extend 2W 2 = Manuf.Spec.2W 3 = Manuf.Spec.3W 4 = Manuf.Spec.4W 5 = Manuf.Spec.5W 6 = Manuf.Spec.6W	Factory Setting: 0
--------------------------	--	---------------------------

P711 - DeviceNet Read Word #3

P712 - DeviceNet Read Word #4

P713 - DeviceNet Read Word #5

P714 - DeviceNet Read Word #6

Adjustable Range:	0 to 1199	Factory Setting: 0
--------------------------	-----------	---------------------------

P715 - DeviceNet Write Word #3

P716 - DeviceNet Write Word #4

P717 - DeviceNet Write Word #5

P718 - DeviceNet Write Word #6

Adjustable Range:	0 to 1199	Factory Setting: 0
--------------------------	-----------	---------------------------

P719 - DeviceNet Network Status

Adjustable Range:	0 = Offline 1 = OnLine, Not Conn 2 = OnLine, Connect. 3 = Connection Timed out 4 = Link Failure 5 = Auto-Baud	Factory Setting:
Properties:	ro	

COMMUNICATION

P720 - DeviceNet Master Status

Adjustable	0 = Run	Factory
Range:	1 = Idle	
Properties:	ro	

P721 - CANopen Comm. Status

Adjustable	0 = Disabled	Factory	
Range:	1 = Reserved		Setting:
	2 = Communic. Enabled		
	3 = Error Ctrl. Enable		
	4 = Guarding Error		
	5 = Heartbeat Error		
Properties:	ro		

P722 - CANopen Node Status

Adjustable	0 = Disabled	Factory	
Range:	1 = Initialization		Setting:
	2 = Stopped		
	3 = Operational		
	4 = Preoperational		
Properties:	ro		

Description:

It provides access for configuration and operation of the CAN interface. For detailed description, refer to manual CANopen communication or DeviceNet communication manual available for download on the website: www.weg.net.

12.6 PROFIBUS DP

See below the parameters to configure and operate the Profibus interface. For detailed description, refer to the communication manual (User) according to the interface used. These manuals are available for download on the website: www.weg.net.

P740 - Profibus Comm. Status

Adjustable	0 = Disabled	Factory	
Range:	1 = Access Error		Setting:
	2 = Offline		
	3 = Config. Error		
	4 = Param. Error		
	5 = Clear Mode		
	6 = Online		
Properties:	ro		

P742 - Profibus Read Word #3

P743 - Profibus Read Word #4

P744 - Profibus Read Word #5**P745 - Profibus Read Word #6**

Adjustable Range:	0 to 1199	Factory Setting:	0
--------------------------	-----------	-------------------------	---

P746 - Profibus Write Word#3**P747 - Profibus Write Word#4****P748 - Profibus Write Word#5****P749 - Profibus Write Word#6**

Adjustable Range:	0 to 1199	Factory Setting:	0
--------------------------	-----------	-------------------------	---

P750 - Profibus Address

Adjustable Range:	1 to 126	Factory Setting:	1
--------------------------	----------	-------------------------	---

P751 - Profibus Teleg. Sel.

Adjustable Range:	1 = Std. Teleg. 1 2 = Telegram 100 3 = Telegram 101 4 = Telegram 102 5 = Telegram 103	Factory Setting:	1
--------------------------	---	-------------------------	---

P754 - Profibus Baud Rate

Adjustable Range:	0 = 9.6 kbit/s 1 = 19.2 kbit/s 2 = 93.75 kbit/s 3 = 187.5 kbit/s 4 = 500 kbit/s 5 = Not Detected 6 = 1500 kbit/s 7 = 3000 kbit/s 8 = 6000 kbit/s 9 = 12000 kbit/s 10 = Reserved 11 = 45.45 kbit/s	Factory Setting:	0
--------------------------	--	-------------------------	---

Description:

It provides access for configuration and operation of the Profibus interface. For a detailed description, refer to the CANopen communication or DeviceNet communication manual available for download on the website: www.weg.net.

COMMUNICATION

12.7 ETHERNET

See below the parameters to configure and operate the Ethernet interface. For detailed description, refer to the communication manual (User) according to the interface used. These manuals are available for download on the website: www.weg.net.

P798 - Enable protocols

Adjustable	0 to 1 (hexa)	Factory	0
Range:	Bit 0 = Web Server	Setting:	

Description:

It allows enabling and disabling functionalities of some protocols, limiting the exposure of the inverter via network. For detailed description, refer to the communication manual (User) according to the interface used. These manuals are they are available for download on the website: www.weg.net.

P850 - IP Address Config

Adjustable	0 = Parameters	Factory	1
Range:	1 = DHCP	Setting:	
Properties:	cfg		

Description:

It defines how to set the IP address for the accessory. For detailed description, refer to the communication manual (User) according to the interface used. These manuals are they are available for download on the website: www.weg.net.

P851 - IP Address 1

Adjustable	0 to 255	Factory	192
Range:		Setting:	
Properties:	cfg		

P852 - IP Address 2

Adjustable	0 to 255	Factory	168
Range:		Setting:	
Properties:	cfg		

P853 - IP Address 3

Adjustable	0 to 255	Factory	0
Range:		Setting:	
Properties:	cfg		

P854 - IP Address 4

Adjustable	0 to 255	Factory	10
Range:		Setting:	
Properties:	cfg		

Description:

It defines the IP address of the Ethernet interface. It is valid only if P850 = Parameters. For detailed description, refer to the communication manual (User) according to the interface used. These manuals are they are available for download on the website: www.weg.net.

P855 - CIDR Sub-net

Adjustable Range:	0 = Reserved 1 = 128.0.0.0 2 = 192.0.0.0 3 = 224.0.0.0 4 = 240.0.0.0 5 = 248.0.0.0 6 = 252.0.0.0 7 = 254.0.0.0 8 = 255.0.0.0 9 = 255.128.0.0 10 = 255.192.0.0 11 = 255.224.0.0 12 = 255.240.0.0 13 = 255.248.0.0 14 = 255.252.0.0 15 = 255.254.0.0 16 = 255.255.0.0 17 = 255.255.128.0 18 = 255.255.192.0 19 = 255.255.224.0 20 = 255.255.240.0 21 = 255.255.248.0 22 = 255.255.252.0 23 = 255.255.254.0 24 = 255.255.255.0 25 = 255.255.255.128 26 = 255.255.255.192 27 = 255.255.255.224 28 = 255.255.255.240 29 = 255.255.255.248 30 = 255.255.255.252 31 = 255.255.255.254	Factory Setting: 24
Properties:	cfg	

Description:

It defines the sub-net mask for the Ethernet interface. It is valid only if P850 = Parameters. For detailed description, refer to the communication manual (User) according to the interface used. These manuals are they are available for download on the website: www.weg.net.

P856 - Gateway 1

Adjustable Range:	0 to 255	Factory Setting: 0
Properties:	cfg	

COMMUNICATION

P857 - Gateway 2

Adjustable Range:	0 to 255	Factory Setting:	0
Properties:	cfg		

P858 - Gateway 3

Adjustable Range:	0 to 255	Factory Setting:	0
Properties:	cfg		

P859 - Gateway 4

Adjustable Range:	0 to 255	Factory Setting:	0
Properties:	cfg		

Description:

It defines the IP address of the default gateway for the Ethernet interface. It is valid only if P850 = Parameters. For detailed description, refer to the communication manual (User) according to the interface used. These manuals are they are available for download on the website: www.weg.net.

P860 - MBTCP: Communication Status

Adjustable Range:	0 = Disabled 1 = No connection 2 = Connected 3 = Timeout Error	Factory Setting:	
Properties:	ro		

P863 - MBTCP: Active Connections

Adjustable Range:	0 to 4	Factory Setting:	
Properties:	ro		

P865 - MBTCP: TCP Port

Adjustable Range:	0 to 9999	Factory Setting:	502
Properties:	cfg		

P868 - MBTCP: Timeout

Adjustable Range:	0.0 to 999.9 s	Factory Setting:	0.0 s
Properties:	cfg		

P869 - EIP: Master Status

Adjustable	0 = Run	Factory
Range:	1 = Idle	
Properties:	ro	Setting:

P870 - EIP: Communication Status

Adjustable	0 = Disabled	Factory
Range:	1 = No connection	
	2 = Connected	
	3 = Timeout in I/O Connection	
	4 = Reserved	
Properties:	ro	Setting:

P871 - EIP: Data Profile

Adjustable	0 to 3 = Reserved	Factory 8
Range:	4 = 120/170: CIP Basic Speed + I/O	
	5 = 121/171: CIP Extended Speed + I/O	
	6 to 7 = Reserved	
	8 = 100/150: Manufac. Speed + I/O	
	9 to 10 = Reserved	
Properties:	cfg	

P872 - Ethernet Read Word #3**P873 - Ethernet Read Word #4****P874 - Ethernet Read Word #5****P875 - Ethernet Read Word #6****P876 - Ethernet Read Word #7****P877 - Ethernet Read Word #8**

Adjustable	0 to 9999	Factory 0
Range:		
		Setting:

P880 - Ethernet Write Word #3**P881 - Ethernet Write Word #4****P882 - Ethernet Write Word #5****P883 - Ethernet Write Word #6**

COMMUNICATION

P884 - Ethernet Write Word #7

P885 - Ethernet Write Word #8

Adjustable Range:	0 to 9999	Factory Setting:	0
--------------------------	-----------	-------------------------	---

P889 - Ethernet Interface Status

Adjustable Range:	0 to 3 (hexa) Bit 0 = Link 1 Bit 1 = Link 2	Factory Setting:	
Properties:	ro		

Description:

It indicates the status of Ethernet interface. For detailed description, refer to the communication manual (User) according to the interface used. These manuals are they are available for download on the website: www.weg.net.

13 SOFTPLC

The SoftPLC function allows the inverter to assume PLC (Programmable Logical Controller). For further details regarding the programming of those functions in the inverter, refer to the “Help” menu of the WPS software.

13.1 COMMAND AND STATUS

See below the parameters related to the SoftPLC commands and states.

P900 - SoftPLC Status

Adjustable Range:	0 = No Application 1 = Installing Application 2 = Incompat. Application 3 = Application Stopped 4 = Application Running	Factory Setting:
Properties:	ro	

Description:

It indicates the status in which the SoftPLC is. If there is no application installed, the parameters P910 to P959 will not be shown on the HMI.

If this parameter presents option 2 = Incompat. App., it indicates the user’s program loaded on the SoftPLC is not compatible with the inverter firmware version.

In this case, it is necessary that the user recompile the project on the WPS, considering the new inverter version and redo the download.

P901 - SoftPLC Command

Adjustable Range:	0 = Stop Application 1 = Run Application	Factory Setting: 0
--------------------------	---	---------------------------

Description:

It allows stopping or running an application installed, but to do so, the motor must be disabled.

P902 - Scan Cycle Time

Adjustable Range:	0.000 to 9.999 s	Factory Setting:
Properties:	ro	

Description:

It indicates the application scanning time. The larger the application, the longer is the scanning time.

P903 - SoftPLC Appl.

Adjustable Range:	0 = User 1 = PID Controller	Factory Setting: 1
Properties:	cfg	

Description:

It configures the application to be executed, according to [Table 13.1 on page 13-2](#).

Table 13.1: Description of the parameter P903 options

P903	Description
0	It defines that the application that will run on the SoftPLC is the one loaded by the user through the ladder programming tool
1	It defines that the application that will run on the SoftPLC is the PID controller



ATTENTION!

It is recommended to load the factory setting (P204 = 5 or 6) after alternating between user's application and PID controller application.

P904 - Action for SoftPLC Application not Running

Adjustable	0 = Disabled	Factory	0
Range:	1 = Cause Alarm (A708)	Setting:	
	2 = Cause Fault (F709)		

Description:

It defines which action will be taken by the product in case the SoftPLC not running condition is detected, and it may generate alarm A708 (1), fault F709 (2) or neither of the previous actions, remaining inactive (0).

13.2 USER

See below the SoftPLC user's parameters.

P910 - SoftPLC Parameter 1

P911 - SoftPLC Parameter 2

P912 - SoftPLC Parameter 3

P913 - SoftPLC Parameter 4

P914 - SoftPLC Parameter 5

P915 - SoftPLC Parameter 6

P916 - SoftPLC Parameter 7

P917 - SoftPLC Parameter 8

P918 - SoftPLC Parameter 9

P919 - SoftPLC Parameter 10

P920 - SoftPLC Parameter 11

P921 - SoftPLC Parameter 12

P922 - SoftPLC Parameter 13

P923 - SoftPLC Parameter 14

P924 - SoftPLC Parameter 15

P925 - SoftPLC Parameter 16

P926 - SoftPLC Parameter 17

P927 - SoftPLC Parameter 18

P928 - SoftPLC Parameter 19

P929 - SoftPLC Parameter 20

P930 - SoftPLC Parameter 21

P931 - SoftPLC Parameter 22

P932 - SoftPLC Parameter 23

P933 - SoftPLC Parameter 24

P934 - SoftPLC Parameter 25

P935 - SoftPLC Parameter 26

P936 - SoftPLC Parameter 27

P937 - SoftPLC Parameter 28

P938 - SoftPLC Parameter 29

P939 - SoftPLC Parameter 30

P940 - SoftPLC Parameter 31

P941 - SoftPLC Parameter 32

P942 - SoftPLC Parameter 33

P943 - SoftPLC Parameter 34

P944 - SoftPLC Parameter 35

P945 - SoftPLC Parameter 36

P946 - SoftPLC Parameter 37

SOFTPLC

P947 - SoftPLC Parameter 38

P948 - SoftPLC Parameter 39

P949 - SoftPLC Parameter 40

P950 - SoftPLC Parameter 41

P951 - SoftPLC Parameter 42

P952 - SoftPLC Parameter 43

P953 - SoftPLC Parameter 44

P954 - SoftPLC Parameter 45

P955 - SoftPLC Parameter 46

P956 - SoftPLC Parameter 47

P957 - SoftPLC Parameter 48

P958 - SoftPLC Parameter 49

P959 - SoftPLC Parameter 50

P960 - SoftPLC Parameter 51

P961 - SoftPLC Parameter 52

P962 - SoftPLC Parameter 53

P963 - SoftPLC Parameter 54

P964 - SoftPLC Parameter 55

P965 - SoftPLC Parameter 56

P966 - SoftPLC Parameter 57

P967 - SoftPLC Parameter 58

P968 - SoftPLC Parameter 59

P969 - SoftPLC Parameter 60

P970 - SoftPLC Parameter 61

P971 - SoftPLC Parameter 62

P972 - SoftPLC Parameter 63

P973 - SoftPLC Parameter 64

P974 - SoftPLC Parameter 65

P975 - SoftPLC Parameter 66

P976 - SoftPLC Parameter 67

P977 - SoftPLC Parameter 68

P978 - SoftPLC Parameter 69

P979 - SoftPLC Parameter 70

Adjustable
Range: -9999 to 9999

Factory 0
Setting:

Description:

These are parameters whose use is defined by the SoftPLC function.



NOTE!

Parameters P910 to P959 can only be viewed when there are application installed.

14 APPLICATIONS

Using the SoftPLC function of the inverter, it is possible to develop an application (or functionality) in ladder language and include it in the inverter software.

Parameter P903 allows selecting the application and uploading it to the SoftPLC execution area of the inverter.

The frequency inverter has the following application already implanted:

- PID Controller.

14.1 PID CONTROLLER

The PID controller application can be used to control a process in closed loop. This application adds a proportional, integral and derivative controller superimposed to the regular speed control of the frequency inverter having selection options:

- Control setpoint source.
- Process variable source.
- Operation mode in manual or automatic mode.
- Alarms by low or high process variable level.
- Configuration of the control action in direct or reverse mode.
- Setting the conditions to activate the sleep and wake up mode.

Basically, the PID controller application compares the control setpoint to the process variable and controls the motor speed to try to eliminate any errors so as to keep the process variable equal to the control setpoint required by the user. The setting of the gains P, I and D determine the speed at which the inverter will respond to eliminate that error. See the PID controller block diagram below.

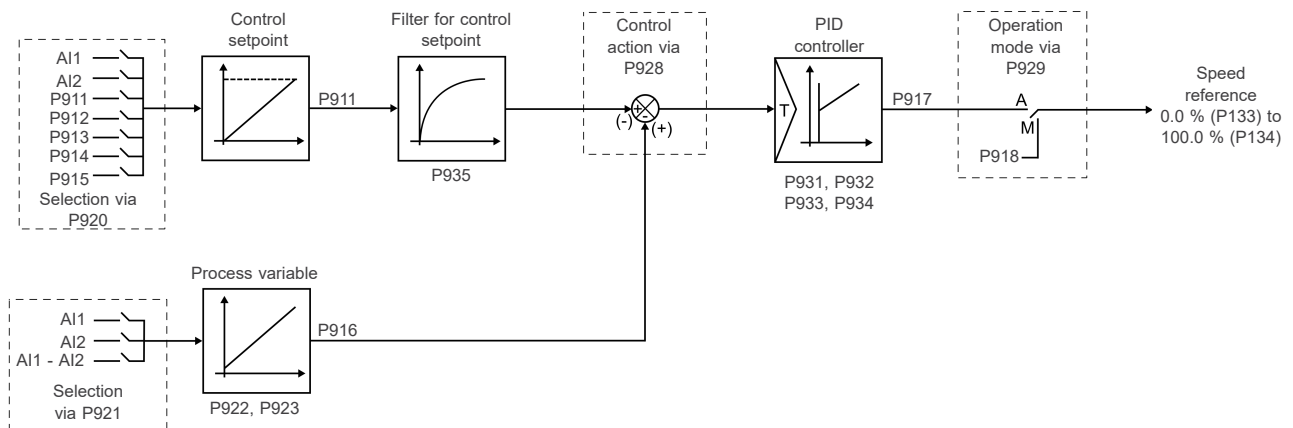

Figure 14.1: PID controller block diagram

Application examples of the PID controller:

- Flow or pressure control in a pipe system.
- Temperature of a furnace or oven.
- Dosing of chemicals in tanks.

APPLICATIONS

The example below defines the terms used by the PID controller application.

An electric pump used in a water pumping system in which the pressure must be controlled at the pump output pipe. A pressure transducer is installed on the pipe and provides an analog feedback signal to the inverter proportional to the water pressure. That signal is called process variable and can be viewed in parameter P916. A control setpoint is programmed in the inverter via HMI (P911), or via analog input (AI1 or AI2), or via electronic potentiometer function (DI3 and DI4), or via logical combination of digital inputs DI3 and DI4 according to the control setpoint source defined in P920. The control setpoint is the water pressure which the pump must produce regardless of the demand variations in the pump output at any moment.

In order to enable the operation of the PID controller application, it is necessary to program the speed reference for the SoftPLC function, that is, parameter P221 or P222 in 12 = SoftPLC, and select the PID controller control action in P928 for direct action (=1) or reverse action (=2), thus enabling the PID operation. Otherwise, the alarm message “A790: Speed reference source (P221 or P222) not programmed for the SoftPLC (12)” will be generated.

The functionalities that can be programmed in the analog and digital inputs and outputs are shown in the [Table 14.1 on page 14-2](#).

Table 14.1: Functionalities and programming of the analog and digital inputs and outputs

Analog Inputs AI1 (P231) and AI2 (P236)	
Control Setpoint	= 16
Process Variable	= 17
Analog Outputs AO1 (P251) and AO2 (P254)	
Control Setpoint	= 29
Process Variable	= 30
Digital Inputs DI2 (P264) to DI4 (P266)	
Manual / Automatic PID (DI2)	= 51
Increase Setpoint Command (PE) (DI3)	= 52
Decrease Setpoint Command (PE) (DI4)	= 53
1 st DI of the Control Setpoint (DI3)	= 54
2 nd DI of the Control Setpoint (DI4)	= 55
Digital Outputs DO1 (P275) to DO4 (P278)	
Process Variable Low Level (A760/F761)	= 46
Process Variable High Level (A762/F763)	= 47

The control setpoint source of the PID controller is defined in parameter P920, and it may be: via parameter P911, which can be changed via HMI (or communication networks); via analog input AI1 or AI2, being parameter P231 (AI1) or P236 (AI2) previously programmed to 16 = Control Setpoint so that it is enabled for operation; via Electronic Potentiometer (EP) through increase and decrease commands in digital inputs DI3 and DI4, being parameter P265 (DI3) previously programmed to 51 = Increase Setpoint Command (EP) and P266 (DI4) to 52 = Decrease Setpoint Command (EP); via logical combination of digital inputs, with the selection of up to four control setpoints, being parameter P265 (DI3) previously programmed to 53 = 1st DI for Control Setpoint and P266 (DI4) to 54 = 2nd DI for Control Setpoint.

The value of the present control setpoint of the PID controller (P911) can be indicated via analog output AO1 or AO2, being necessary to program P251 (AO1) or P254 (AO2) to 29 = Control Setpoint. The variable full scale is 100.0 % and corresponds to 10 V or 20 mA.

The source of the PID controller process variable is defined in parameter P921, and it can be via analog input AI1 and/or AI2, being then parameter P231 (AI1) and/or P236 (AI2) previously programmed to 17 = Process Variable.

The value of the PID controller process variable (P916) can be indicated via analog output AO1 or AO2, being necessary to program P251 (AO1) or P254 (AO2) to 30 = Process Variable. The variable full scale is 100.0 % and corresponds to 10 V or 20 mA.

The PID controller operation mode is defined in parameter P929, which can be manual, always automatic or via a Manual/Automatic command through digital input DI2, being then parameter P264 (DI2) previously programmed to 50 = Man/Auto PID Selection. Digital input DI2 programmed to PID in Manual/Automatic is active while it is at logical level “1”, indicating automatic command, and inactive at logical level “0”, indicating manual command.

Digital outputs DO1 to DO4 can be programmed to indicated alarm/fault conditions for low level or high level of the process variable (PV), seeing that one of the respective parameters (P275 to P278) must be programmed to 46 = Process Variable Low Level (equivalent to $PV < PV_y$) or 47 = Process Variable High Level (equivalent to $PV > PV_x$).

14.1.1 Start-Up

See below the required steps to put the PID controller application into operation.



NOTE!

For the PID controller application to work properly, it essential to check if the inverter is configured properly to drive the motor at the desired speed. In order to do so, check the following settings:

- Acceleration and deceleration ramps (P100 to P101).
- Current limit (P135) for V/f and VVW control modes.
- Torque boost (P136 and P137) and slip compensation (P138) if in the V/f control mode.

Configuring the PID Controller Application The PID controller application will be configured according to the example shown below, where:

- The frequency inverter will be configured to operate in the local mode.
- Digital input DI1 will be used for the Run/Stop command in local mode.
- Digital input DI2 will be used to select the PID to Manual/Automatic.
- The PID controller process variable (PV) will be connected to analog input AI1 in the scale of 4-20 mA, where 4 mA is equal to 0 bar and 20 mA is equal to 4.0 bar.
- The PID controller control setpoint (SP) will be via HMI (keys).

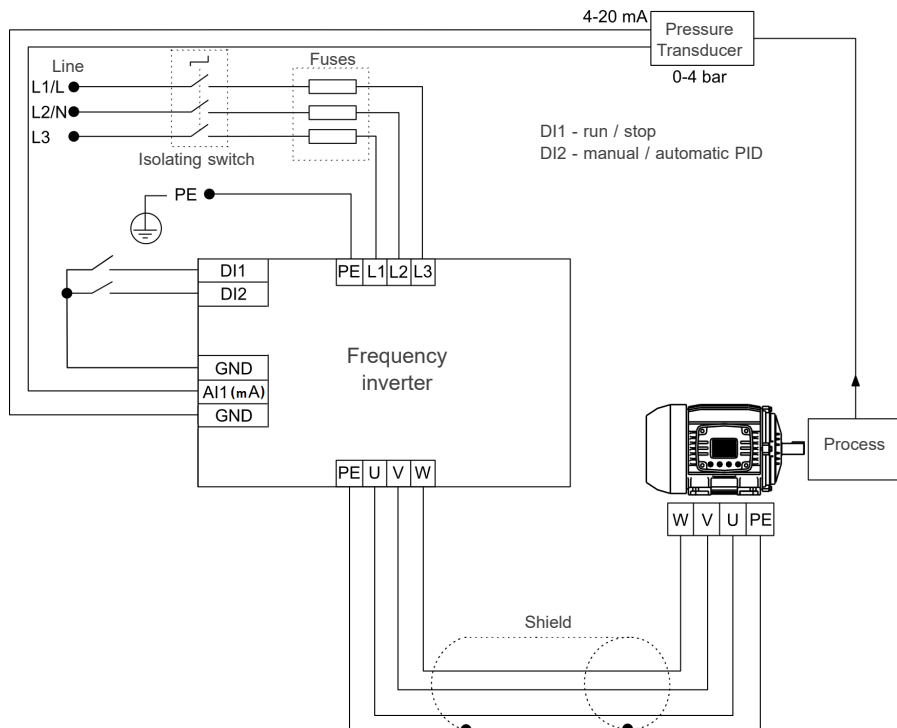

Figure 14.2: Example of the PID controller application

APPLICATIONS

Table 14.2: Programming sequence of the PID controller application

Seq.	Action / Result	Indication on the Display
1	It selects the PID controller application in the SoftPLC function of the inverter	P903 = 1
2	It enables the execution of the PID controller application	P901 = 1
3	It selects the PID controller control action, thus enabling its operation and uploading, at this moment the application default setting (which is indicated below) to the frequency inverter. 1 = Direct	P928 = 1
4	Acceleration time in seconds	P100 = 2.5 s
5	Deceleration time in seconds	P101 = 2.5 s
6	Minimum frequency	P133 = 40.0 Hz
7	Maximum frequency	P134 = 60.0 Hz
8	It selects the parameter of the HMI main display to show the value of the PID controller process variable. This setting is optional	P205 = 916
9	It selects the HMI bar graph parameter to show the present motor speed. This setting is optional	P207 = 002
10	Full scale of the Speed Reference	P208 = 600
11	Engineering unit of the Speed Reference	P209 = 3
12	Speed Reference indication form	P210 = 1
13	Full scale of the HMI bar graph	P213 = 600
14	LOC/REM Source Selection. 0 = Always Local	P220 = 0
15	Selection of the Reference in Local mode. 12 = SoftPLC	P221 = 12
16	Selection of the Run/Stop Command in Local mode. 1 = Dlx	P224 = 1
17	AI1 Signal Function. 17 = Process Variable (PV)	P231 = 17
18	AI1 Gain	P232 = 1.000
19	AI1 Signal. 0 = 0 to 10 V / 20 mA	P233 = 0
20	Offset AI1	P234 = 0.00 %
21	Filter AI1	P235 = 0.25 s
22	Digital input DI1 is used for the motor run or stop command. 1 = run/stop	P263 = 1
23	Digital input DI2 is used to set the PID to Automatic or Manual. 50 = PID Man / Auto	P264 = 50
24	SoftPLC Engineering Unit. 0 = none. The sensor of the process variable is in bar, and this variable is not available on the inverter	P510 = 0
25	Indication form of the SoftPLC engineering unit. 2 = wx.yz	P511 = 2
26	It selects the PID controller operation mode. 2 = manual/automatic via DI2	P929 = 2
27	It selects the automatic setting mode of the control setpoint. 0 = P911 inactive and P918 inactive	P930 = 0
28	The PID controller Setpoint will be set via HMI. 0 = via HMI	P920 = 0
29	The PID Process Variable will be read via analog input AI1. 1 = via AI1	P921 = 1
30	The range of the sensor connected to analog input AI1 is 0 to 4.0 bar. Program this parameter for the minimum sensor value, which is the minimum of the analog input 4 mA	P922 = 0.00
31	The range of the sensor connected to analog input AI1 is 0 to 4.0 bar. Program this parameter for the maximum sensor value, which is the maximum of the analog input 20 mA	P923 = 4.00
32	Setting of the control Setpoint via HMI	P911 = 2.00
33	Control Setpoint Filter	P935 = 0.150 s
34	PID controller Sampling Period	P934 = 0.100 s
35	Proportional Gain of the PID controller	P931 = 1.00
36	Integral Gain of the PID controller	P932 = 5.00
37	Derivative Gain of the PID controller	P933 = 0.00

Parameters P931, P932, P933 and P934 must be set according to the response of the process to be controlled. See below suggestions for initial values of sampling time and gain setting for the PID controller according to the process to be controlled.

Table 14.3: Suggestions for the PID controller gain settings

Quantity	Sampling Time P934	Gains		
		Proportional P931	Integral P932	Derivative P933
Pressure in pneumatic system	0.10 s	1.00	5.00	0.00
Flow in pneumatic system	0.10 s	1.00	5.00	0.00
Pressure in hydraulic system	0.10 s	1.00	5.00	0.00
Flow in hydraulic system	0.10 s	1.00	5.00	0.00
Temperature	0.50 s	2.00	0.50	0.10

Putting into Operation Check the state of the PID controller application in parameter P900. Value equal to 4 indicates the application is already in operation. Value equal to 3 indicates the application is stopped; therefore, it is necessary to change the command value for the SoftPLC in parameter P901 to 1 (execute application). Value different from 3 or 4 indicates the application cannot go into operation. For further details, refer to the inverter SoftPLC manual.

1. **Manual Operation (DI2 open):** keeping DI2 open (Manual), check the indication of the process variable on the HMI (P916) based on an external measurement of the sensor signal (transducer) in analog input AI1.

Then, changes the manual setpoint value of the PID controller (P918) until reaching the desired process variable value. Check if the control setpoint value (P911) is set to this value, and then put the PID controller into the automatic mode.



NOTE!

The PID controller only begins the speed regulation when the motor reaches the minimum speed programmed in P133, as it was configured to operate from 0.0 to 100.0 %, where 0.0 % corresponds to the minimum speed programmed in P133, and 100.0 % corresponds to the maximum speed programmed in P134.

2. **Automatic Operation (DI2 closed):** close DI2 and make the dynamic adjustment of the PID controller, that is, of the proportional (P931), integral (P932) and derivative (P933) gains, checking if the regulation is being done correctly. In order to do so, just compare the control setpoint and the process variable and check if the values are close. Also check how fast the motor responds to the oscillations of the process variable.

It is important to point out that the setting of the PID controller gains is a step that requires some attempt and error procedure to reach the desired response time. If the system responds quickly and oscillates close to the control setpoint, then the proportional gain is too high. If the system responds slowly and it takes a long time to reach the control setpoint, the proportional gain is too low and must be increased. In case the process variable does not reach the required value (control setpoint), the integral gain must be set then.

14.1.2 Academic PID Controller

The PID controller implemented on the inverter is academic. See below the equations that characterize the Academic PID controller, which is the base of this function algorithm.

The transfer function in the frequency domain of the Academic PID controller is:

$$y(s) = K_p \times e(s) \times \left[1 + \frac{1}{sT_i} + sT_d \right]$$

Replacing the integrator by a sum and the derivative by the incremental quotient, we obtain the approximation for the discrete (recursive) transfer equation presented below:

$$y(k) = i(k - 1) + K_p \left[(1 + K_i T_a + K_d / T_a) e(k) - (K_d / T_a) E(k - 1) \right] \times 10$$

Where:

y(k): present output of the PID controller; it may vary from 0.0 to 100.0 %.

APPLICATIONS

i(k-1): integral value in the previous state of the PID controller.

K_p: Proportional gain = P931.

K_i: Integral gain = P932 = $[1 / T_i (s)]$.

K_d: Differential gain = P933 = $[T_d (s)]$.

T_a: sampling period of the PID controller = P934.

e(k): present error, being $[SP(k) - PV(k)]$ for direct action, and $[PV(k) - SP(k)]$ for reverse action.

e(k-1): previous error, being $[SP(k-1) - PV(k-1)]$ for direct action, and $[PV(k-1) - SP(k-1)]$ for reverse action.

SP: present control setpoint of the PID controller.

PV: process variable of the PID controller, read through the analog inputs (AI1 and AI2).

14.1.3 Parameters

See below the description of the parameters related to the PID controller application.

P910 - PID Controller Application Version

Adjustable Range: 0.00 to 90.00

Factory Setting:

Properties: ro

Description:

It indicates the software version of the PID controller application developed for the SoftPLC function of frequency inverter.

P911 - Control Setpoint

Adjustable Range: -99.99 to 99.99

Factory Setting: 2.00

Description:

It defines the setpoint value in automatic mode for the PID controller in engineering unit when the control setpoint source is programmed to be via HMI or communication networks (P920 = 0). When the control setpoint source is programmed for some other source (P920 ≠ 0), this parameter will show the present setpoint in automatic mode for the PID controller.



NOTE!

This parameter will be viewed according to the selection of the parameters for the SoftPLC engineering unit (P510 and P511).

P912 - Control Setpoint 1

Adjustable Range: -99.99 to 99.99

Factory Setting: 2.00

P913 - Control Setpoint 2

Adjustable Range: -99.99 to 99.99

Factory Setting: 2.30

P914 - Control Setpoint 3

Adjustable Range:	-99.99 to 99.99	Factory Setting:	1.80
--------------------------	-----------------	-------------------------	------

P915 - Control Setpoint 4

Adjustable Range:	-99.99 to 99.99	Factory Setting:	1.60
--------------------------	-----------------	-------------------------	------

Description:

It defines the setpoint value in automatic mode of the PID controller in engineering unit when the control setpoint source is programmed to be via logical combination of digital inputs DI3 and DI4 (P950 = 4, 5 or 6) according to [Table 14.6 on page 14-11](#).



NOTE!

These parameters will be viewed according to the selection of the parameters for the SoftPLC engineering unit (P510 and P511).

P916 - Control Process Variable

Adjustable Range:	-99.99 to 99.99	Factory Setting:	
Properties:	ro		

Description:

It indicates the value of the PID controller process variable according to the source defined in P921 and scale defined in P922 and P923.



NOTE!

This parameter will be viewed according to the selection of the parameters for the SoftPLC engineering unit (P510 and P511).

The conversion of the value read by the analog input in percentage into the value of the process variable shown in P916 according to the scale is done through the following formula:

$$P916 = [\text{Value AI}(\%) \times (P923 - P922)] + P922$$

P917 - PID Controller Output

Adjustable Range:	0.0 to 100.0 %	Factory Setting:	
Properties:	ro		

Description:

It indicates, in percentage (%), the value of the PID controller output, where 0.0 % corresponds to the motor minimum speed (P133), and 100.0 % corresponds to the motor maximum speed (P134).

P918 - PID Controller Setpoint in Manual Mode

Adjustable Range:	0.0 to 400.0 Hz	Factory Setting:	0.0 Hz
--------------------------	-----------------	-------------------------	--------

APPLICATIONS

Description:

It defines the value of the PID controller output when it is in the manual mode, that is, when the PID controller works in manual mode, the value defined as manual setpoint is transferred directly to the PID controller output.

P919 - PID Controller Logical Status

Adjustable Range:	0 to FFFF (hexa) Bit 0 = Sleep Mode Active (A750) Bit 1 = PID in Manual (0) / Automatic (1) Bit 2 = PV Low Level (A760) Bit 3 = PV Low Level (F761) Bit 4 = PV High Level (A762) Bit 5 = PV High Level (F763) Bit 6 to 15 = Reserved	Factory Setting:
Properties:	ro	

Description:

Provides access for monitoring the logical status of the PID controller application. Each bit represents a state.

Table 14.4: Description of the logical status of the PID controller application

Bits	15	14	13	12	11	10	9	8	7	6	5	4	3	2	1	0
Function	Reserved										Process Variable High Level (F763)	Process Variable High Level (A762)	Process Variable Low Level (F761)	Process Variable Low Level (A760)	PID controller in Manual or Automatic	Sleep Mode Active (A750)

Bits	Values
Bit 0 Sleep Mode Active (A750)	0: Inverter is not in the alarm condition 1: It indicates that the PID controller is in the sleep mode (A750)
Bit 1 PID Controller in Manual or Automatic	0: PID controller operating in Manual mode 1: PID controller operating in Automatic mode
Bit 2 Control Process Variable Low (A760)	0: Inverter is not in the alarm condition 1: It indicates that the control process variable (P916) is in low level (A760)
Bit 3 Fault for Control Process Variable Low Level (F761)	0: Inverter is not in the fault condition 1: It indicates that the inverter switched the motor off due to the control variable low level (F761)
Bit 4 Control Process Variable High Level (A762)	0: Inverter is not in the alarm condition 1: It indicates that the control process variable (P916) is in high level (A762)
Bit 5 Fault for Control Process Variable High Level (F763)	0: Inverter is not in the fault condition 1: It indicates that the inverter switched the motor off due to the control process variable high level (F763)
Bit 6 Reserved	Reserved
Bit 7 Reserved	Reserved
Bit 8 Reserved	Reserved
Bit 9 Reserved	Reserved
Bit 10 Reserved	Reserved
Bit 11 Reserved	Reserved
Bit 12 Reserved	Reserved
Bit 13 Reserved	Reserved
Bit 14 Reserved	Reserved
Bit 15 Reserved	Reserved

P920 - Selection of the Control Setpoint Source

Adjustable Range:	0 = Control Setpoint via HMI or Communication Networks (P911) 1 = Control Setpoint via Analog Input AI1 2 = Control Setpoint via Analog Input AI2 3 = Control Setpoint via Electronic Potentiometer (EP) 4 = Two Setpoints via Digital Input DI3 (P912 and P913) 5 = Three Setpoints via Digital Inputs DI3 and DI4 (P912, P913 and P914) 6 = Four Setpoints via Digital Inputs DI3 and DI4 (P912, P913, P914 and P915)	Factory Setting: 0
Properties:	cfg	

APPLICATIONS

Description:

It configures the control setpoint source in automatic mode of the PID controller.

Table 14.5: Description of the control setpoint source

P920	Description
0	It defines that the control setpoint source in automatic mode of the PID controller will be the value programmed in parameter P911 via HMI of the frequency inverter or written via communication networks
1	It defines that the control setpoint source in automatic mode of the PID controller will be the value read by the analog input AI1. The value is converted according to the engineering unit 1 and viewed in parameter P911
2	It defines that the control setpoint source in automatic mode of the PID controller will be the value read by the analog input AI2. The values is converted according to the engineering unit 1 and viewed in parameter P911
3	It defines that the control setpoint source in automatic mode of the PID controller will be the value defined through the electronic potentiometer function via the Increase Setpoint (DI3) and Decrease Setpoint (DI4) commands. The value of the count is stored in parameter P911
4	It defines that there will be two control setpoints in automatic mode of the PID controller selected via logical combination of digital input DI3. The selected control setpoint value is viewed in parameter P911
5	It defines that there will be three control setpoints in automatic mode of the PID controller selected via logical combination of digital inputs DI3 and DI4. The selected control setpoint value is viewed in parameter P911
6	It defines that there will be four control setpoints in automatic mode of the PID controller selected via logical combination of digital inputs DI3 and DI4. The selected control setpoint value is viewed in parameter P911

When the control setpoint is via Electronic Potentiometer (EP) function (P920 = 3), the control setpoint of the PID controller is adjusted by means of digital inputs DI3 and DI4, being DI3 to increase it and DI4 to decrease it.

Figure 14.3 on page 14-10 shows the operation of the EP function: when digital input DI3 is activated, the control setpoint value (P911) is incremented, and when digital input DI4 is activated, the control setpoint value (P911) is decremented. In case both digital inputs are activated at the same time, the value remains the same.

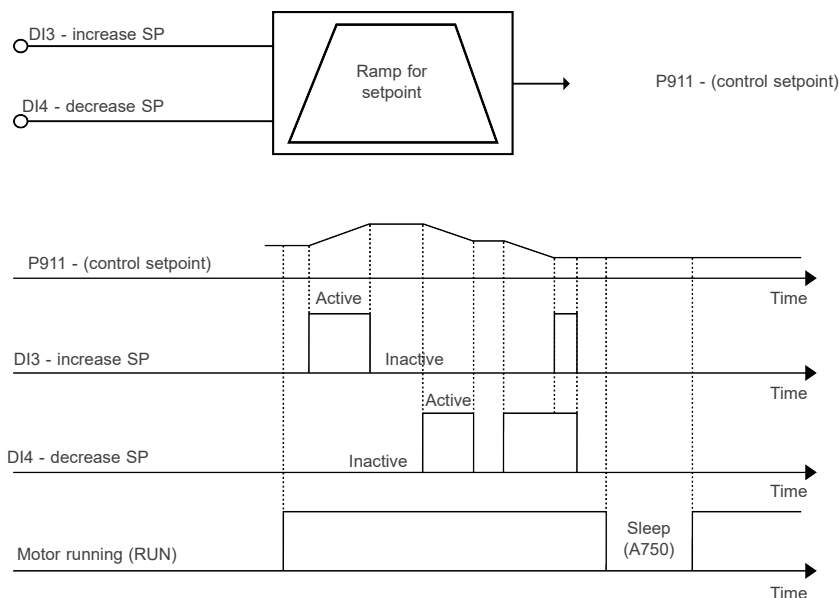

Figure 14.3: PID controller block diagram

When the control setpoint is via logical combination of digital inputs DI3 and DI4 (P920 = 4, 5 or 6), the following truth table must be used so as to obtain the control setpoint of the PID controller in automatic mode.

Table 14.6: Truth table for the control setpoint via logical combination of digital inputs DI3 and DI4

	P912 - Control Setpoint 1	P913 - Control Setpoint 2	P914 - Control Setpoint 3	P915 - Control Setpoint 4
Digital input DI3	0	1	0	1
Digital input DI4	0	0	1	1

P921 - Selection of the Control Process Variable Source

Adjustable Range:	1 = Control Process Variable via Analog Input AI1 2 = Control Process Variable via Analog Input AI2 3 = Control Process Variable via Difference between Analog Input AI1 and AI2	Factory Setting:	1
Properties:	cfg		

Description:

It configures the source of the PID controller process variable.

Table 14.7: Description of the source of the PID controller process variable

P921	Description
1	It defines that the control variable source will be the value read by AI1 and viewed in parameter P916
2	It defines that the control variable source will be the value read by AI2 and viewed in parameter
3	It defines that the control variable source will be the value read by AI1 minus the value read by AI2 that is, the difference between AI1 and AI2, and viewed in parameter P916

P922 - Minimum Sensor Level of the Control Process Variable

Adjustable Range:	-99.99 to 99.99	Factory Setting:	0.00
--------------------------	-----------------	-------------------------	------

Description:

It defines the minimum value of the sensor connected to the analog input configured for the PID controller process variable according to its engineering unit.



NOTE!

This parameter will be viewed according to the selection of the parameters for the SoftPLC engineering unit (P510 and P511).

P923 - Maximum Sensor Level of the Control Process Variable

Adjustable Range:	-99.99 to 99.99	Factory Setting:	4.00
--------------------------	-----------------	-------------------------	------

Description:

It defines the maximum value of the sensor connected to the analog input configured for the PID controller process variable according to its engineering unit.



NOTE!

This parameter will be viewed according to the selection of the parameters for the SoftPLC engineering unit (P510 and P511).

APPLICATIONS

P924 - Value for Low Level Alarm for the Control Process Variable

Adjustable Range:	-99.99 to 99.99	Factory Setting:	1.00
--------------------------	-----------------	-------------------------	------

Description:

It defines the value below which the low level alarm will be generated for the control process variable (A760).

**NOTE!**

Setting it to "0" disables the low level alarm and fault for the control process variable.

**NOTE!**

This parameter will be viewed according to the selection of the parameters for the SoftPLC engineering unit (P510 and P511).

P925 - Time for Low Level Fault for the Control Process Variable

Adjustable Range:	0.0 to 999.9 s	Factory Setting:	0.0 s
--------------------------	----------------	-------------------------	-------

Description:

It defines how long the low level alarm condition should remain so that the control process variable (A760) will generate fault "F761: Low Level Fault of the Control Process Variable".

**NOTE!**

Setting it to "0.0 s" disables the low level fault for the control process variable.

P926 - Value for High Level Alarm for the Control Process Variable

Adjustable Range:	-99.99 to 99.99	Factory Setting:	3.50
--------------------------	-----------------	-------------------------	------

Description:

It defines the value above which the high level alarm will be generated for the control process variable (A762).

**NOTE!**

Setting it to "0" disables the high level alarm and fault for the control process variable.

**NOTE!**

This parameter will be viewed according to the selection of the parameters for the SoftPLC engineering unit (P510 and P511).

P927 - Time for High Level Fault for the Control Process Variable

Adjustable Range:	0.0 to 999.9 s	Factory Setting:	0.0 s
--------------------------	----------------	-------------------------	-------

Description:

It defines how long the high level alarm condition should remain so that the control process variable (A762) will generate fault "F763: High Level Fault of the Control Process Variable".



NOTE!

Setting it to "0.0 s" disables the high level fault for the control process variable.

P928 - Selection of the PID Controller Control Action

Adjustable Range:	0 = Disable PID Controller 1 = Enable PID Controller in Direct Mode 2 = Enable PID Controller in Reverse Mode	Factory Setting: 0
Properties:	cfg	

Description:

It allows enabling the PID controller and defines how the control action will be.

Table 14.8: Description of the PID controller control action

P928	Description
0	It defines that the PID controller will be disabled
1	It defines that the PID controller will be enabled, and the regulation or control action will be in direct mode. In other words, the error will be the control setpoint value (P911) minus the control process variable value (P916)
2	It defines that the PID controller will be enabled, and the regulation or control action will be in reverse mode. In other words, the error will be the control process variable value (P916) minus the control setpoint value (P911)



NOTE!

When enabling the PID controller, that is, changing the content of parameter P928 from 0 to 1 or 2 (with application running), the following parameters related to the PID controller application will be loaded: P100, P101, P133, P134, P205, P207, P208, P209, P210, P213, P220, P221, P224, P231, P232, P233, P234, P235, P263, P264, P510, P511, P911, P912, P913, P914, P915, P918, P920, P921, P922, P923, P924, P925, P926, P927, P929, P930, P931, P932, P933, P934, P935, P936, P937, P938, P939.



NOTE!

The control action of the PID controller must be selected for direct mode when it is necessary to increase the PID controller output in order to increase the process variable value. E.g.: Pump driven by an inverter and filling a tank. For the level of the tank (process variable) to increase, it is necessary that the flow increase, which is accomplished by increasing the speed of the motor. The control action of the PID controller must be selected for reverse mode when it is necessary to decrease the PID controller output in order to increase the process variable value. E.g.: Fan driven by inverter cooling a refrigeration tower. When an increase in temperature is desired (process variable), it is necessary to reduce the ventilation by reducing the motor speed.

P929 - PID Controller Operation Mode

Adjustable Range:	0 = Manual 1 = Automatic 2 = Select Control to Manual (0) or Automatic (1) via digital input DI2	Factory Setting: 2
--------------------------	--	---------------------------

APPLICATIONS

Description:

It configures the operation mode of the inverter PID controller.

Table 14.9: Description of the PID controller operation mode

P929	Description
0	It defines that the PID controller will always operate in manual mode. In other words, the process variable will not be controlled according to the control setpoint required by the user, and the PID controller output value will be the setpoint value in manual mode programmed in parameter P918
1	It defines that the PID controller will operate in automatic mode, that is, the process variable will be controlled according to the control setpoint required by the user and the PID controller output value will behave according to the settings defined by the user
2	It defines the PID controller will be able to operate in manual or automatic mode according to the state of digital input DI2. In other words, if the digital input is in logical level "0", the PID controller will operate in manual mode; if the digital input is in logical level "1", the PID controller will operate in automatic mode



NOTE!

The change from an operation mode to another with the motor running may cause disturbances on the system control. That can be optimized according to the automatic adjustment mode of the PID controller setpoint defined in parameter P930 together with the bumpless transfer characteristic from the manual mode to the automatic mode of the PID block of the SoftPLC function. Bumpless transfer is merely making the transfer from the manual mode to the automatic mode without causing variation in the PID controller output. In other words, when the transition from the manual mode to the automatic mode occurs, the PID controller output value in manual mode is used to start the integral part of the PID controller in automatic mode. That ensures that the output will start from this value.

P930 - Automatic Adjustment of the PID Controller Setpoint

Adjustable Range:	0 = P911 inactive and P918 inactive 1 = P911 active and P918 inactive 2 = P911 inactive and P918 active 3 = P911 active and P918 active	Factory Setting: 0
--------------------------	--	---------------------------

Description:

It configures the PID controller setpoint in the transition of the PID controller operation mode. This parameter defines if the PID controller setpoint in automatic mode (P911) and/or in manual mode (P918) will be automatically changed or adjusted when the PID controller operation mode changes.

Table 14.10: Description of the PID controller setpoint automatic adjustment

P930	Description
0	It defines that, in the transition of the PID controller operation mode from manual to automatic, the control setpoint value (P911) will not be uploaded with the present value of the control process variable (P916), and, in the transition of the PID controller operation mode from automatic to manual, the setpoint value of the PID controller in manual mode (P918) will not be uploaded with the present value of the motor speed (P002)
1	It defines that, in the transition of the PID controller operation mode from manual to automatic, the control setpoint value (P911) will be uploaded with the present value of the control process variable (P916), and, in the transition of the PID controller operation mode from automatic to manual, the setpoint value of the PID controller in manual mode (P918) will not be uploaded with the present value of the motor speed (P002)
2	It defines that, in the transition of the PID controller operation mode from manual to automatic, the control setpoint value (P911) will not be uploaded with the present value of the control process variable (P916), and, in the transition of the PID controller operation mode from automatic to manual, the setpoint value of the PID controller in manual mode (P918) will be uploaded with the present value of the motor speed (P002)
3	It defines that, in the transition of the PID controller operation mode from manual to automatic, the control setpoint value (P911) will be uploaded with the present value of the control process variable (P916), and, in the transition of the PID controller operation mode from automatic to manual, the setpoint value of the PID controller in manual mode (P918) will be uploaded with the present value of the motor speed (P002)



NOTE!

The adjustment of the control setpoint in automatic mode is only valid when the control setpoint source is HMI or communication networks (P920 = 0) or via the Electronic Potentiometer Function (P920 = 3). For other control setpoint sources, the automatic adjustment is not executed.

P931 - Proportional Gain

Adjustable Range:	0.00 to 99.99	Factory Setting:	1.00
--------------------------	---------------	-------------------------	------

P932 - Integral Gain

Adjustable Range:	0.00 to 99.99	Factory Setting:	5.00
--------------------------	---------------	-------------------------	------

P933 - Derivative Gain

Adjustable Range:	0.00 to 99.99	Factory Setting:	0.00
--------------------------	---------------	-------------------------	------

Description:

It define gains of the PID controller and must be set according to the magnitude or process that is being controlled.



NOTE!

[Table 14.3 on page 14-5](#) suggests setting values for the gains according to the process to be controlled by the PID controller.

P934 - PID Controller Sampling Period

Adjustable Range:	0.050 to 9.999 s	Factory Setting:	0.100 s
Properties:	cfg		

Description:

It defines the sampling time of the PID controller.



NOTE!

[Table 14.3 on page 14-5](#) suggests setting values for the sampling time according to the process to be controlled by the PID controller.

P935 - Filter for the PID Controller Control Setpoint

Adjustable Range:	0.000 to 9.999 s	Factory Setting:	0.150 s
--------------------------	------------------	-------------------------	---------

Description:

It defines the time constant of the 1st order filter to be applied to the PID controller control setpoint, and it is intended to reduce sudden changes in the control setpoint value of the PID controller.

APPLICATIONS

14.1.4 Sleep Mode

This parameter group allows the user to set the operation conditions of the sleep mode.

Sleep Mode is a controlled system state in which the control demand is zero or almost zero, and, at this moment, the motor driven by the frequency inverter may be switched off. That prevents the motor from running at a low speed, doing little or nothing for the controlled system. Even if the motor is apparently OFF, the process variable continues to be monitored so that, when necessary, the controlled system can start the motor again according to the conditions of the wake up mode.

Wake Up Mode switches on the motor when the difference between the control process variable and the control setpoint is greater than a certain programmed value.



NOTE!

The sleep mode only actuates if the PID controller is enabled and in the automatic mode.



DANGER!

When the inverter is in the sleep mode, the motor may spin at any moment because of the process conditions. If you wish to handle the motor or execute any kind of maintenance, power down the inverter.

P936 - Deviation of the Control Process Variable to Wake Up

Adjustable Range: -99.99 to 99.99

Factory Setting: 0.30

Description:

It defines the value to be subtracted from (direct PID) or added to (reverse PID) the control setpoint to start the motor and return to the system control. This value is compared to the control process variable, and, if the control process variable value is smaller (direct PID) or greater (reverse PID) than this value, the wake up condition is enabled.



NOTE!

This parameter will be viewed according to the selection of the parameters for the SoftPLC engineering unit (P510 and P511).

P937 - Time to Wake Up

Adjustable Range: 0.0 to 999.9 s

Factory Setting: 5.0 s

Description:

It defines the time the wake up mode active condition should remain to start the motor and control the system. The control process variable must remain smaller (direct PID) or greater (reverse PID) than the deviation defined in P936 for the time set in P937 for the motor to be started and its speed controlled. In case the wake up condition (P937) remains inactive for some time, the timer is reset and the time count is restarted.



NOTE!

If, in the energization of the inverter, the "Run/Stop" command is active and the condition to Wake Up is active, the time programmed in P937 will not be waited for, and thus the motor will be started instantly.

P938 - Motor Speed to activate the Sleep Mode

Adjustable Range:	0.0 to 400.0 Hz	Factory Setting:	0.0 Hz
--------------------------	-----------------	-------------------------	--------

Description:

It defines the motor speed value below which the motor will be switched off and go into the sleep mode.



NOTE!

Setting it to "0.0 Hz" disables the sleep mode; that means the motor will be switched on or off according to the state of the "Run/Stop" command.

P939 - Time to activate de Sleep Mode

Adjustable Range:	0.0 to 999.9 s	Factory Setting:	10.0 s
--------------------------	----------------	-------------------------	--------

Description:

It defines the time the motor speed should remain below the value set in P938 for the motor to be switched off and go into the sleep mode.



NOTE!

The alarm message "A750: Sleep Mode Active" will be shown on the HMI of the frequency inverter warning that the motor is in the sleep mode.

Figure 14.4 on page 14-18 shows an analysis of the PID controller operation programmed with control action in direct mode and configured for the Sleep Mode.

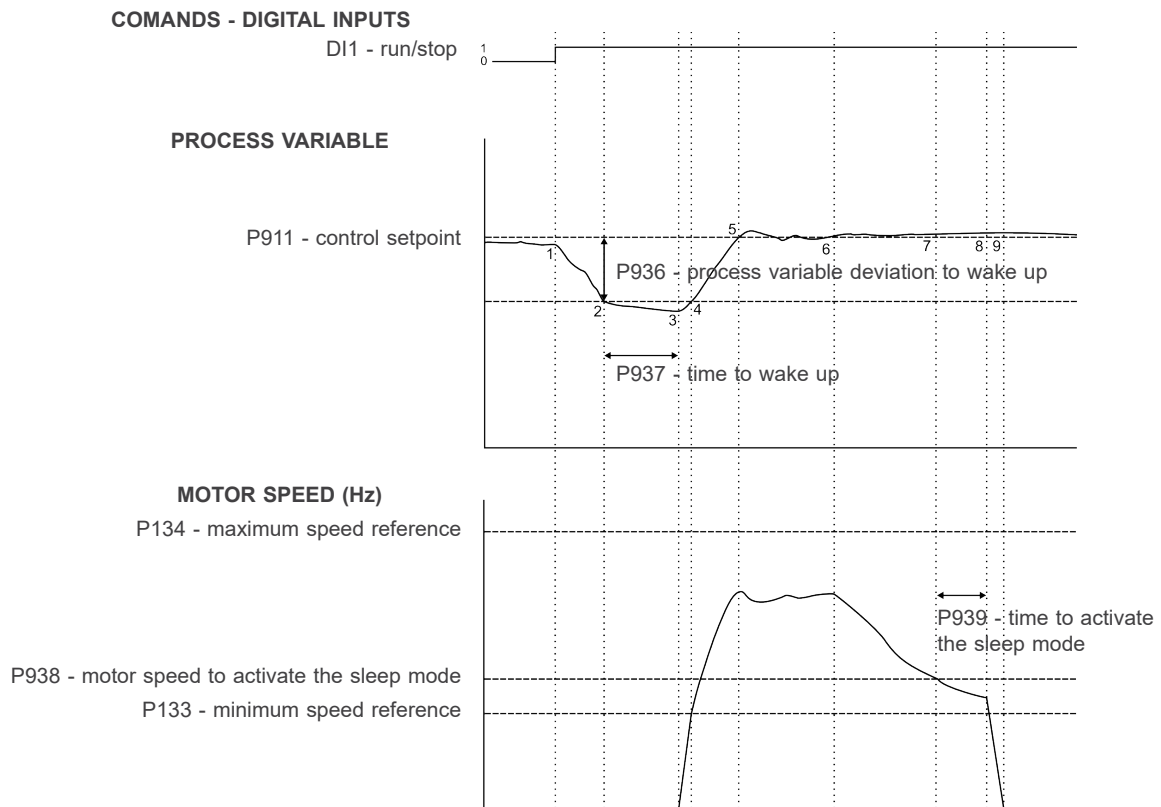

Figure 14.4: Operation of the PID controller with the sleep mode enabled

1. The Run/Stop command via digital input D11 enables the starting of the motor. As the wake up condition was not detected, it remains in sleep mode, and the motor remains stopped.
2. The process variable starts to decrease and becomes smaller than the deviation of the process variable programmed to wake up (P936); at this moment, the time count to wake up (P937) begins.
3. The process variable remains smaller than the process variable deviation to wake up (P936), and the time to wake up (P937) elapses; at this moment, the command to start the motor and control the system with its speed variation is executed.
4. The inverter accelerates the motor up to the minimum speed (P133). After that, the PID controller is enabled and starts controlling the motor speed.
5. Then it is possible to control the process variable so that it reaches the control setpoint required by the user. To that end, the PID controller output is incremented, making the motor speed increase until reaching the control stabilization.
6. The value of the process variable remains above the required control setpoint due to a decrease in demand, and the motor speed starts slowing down.
7. The value of the motor speed falls below the value to sleep (P938); the time count to activate the sleep mode (P939) begins.
8. The motor speed remains below the value to sleep (P938), and the time to activate the sleep mode (P939) elapses; at this moment, the command to switch off the motor is executed.
9. The motor is decelerated down to 0 Hz and remains stopped; at this moment the PID controller goes into the sleep mode.

15 APPLICATION EXAMPLES

This chapter presents typical application examples.

15.1 ANALOG INPUT APPLICATIONS

In this section some applications that use analog inputs are shown. [Figure 15.1 on page 15-1](#) presents some possible connections. The applications described here require load factory settings (P204 = 5 or 6) for correct execution.

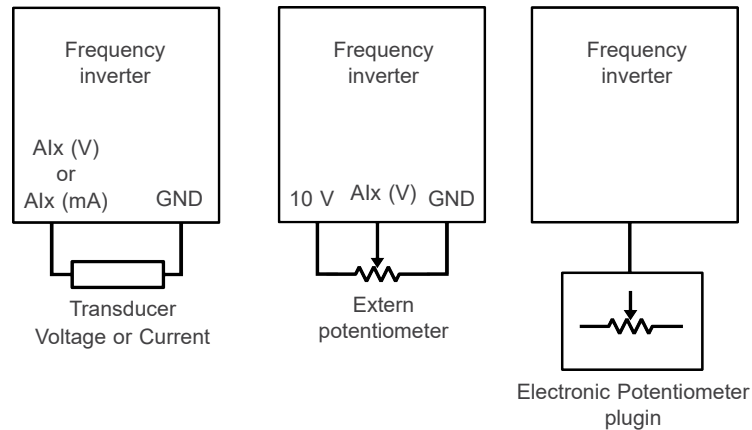

Figure 15.1: Connections for analog inputs

The results for the equations presented in [Section 9.1 ANALOG INPUTS in page 9-1](#) are shown on P018 or P020 according to the availability of analog inputs from the inverter. This readings can be used for options given by P231 or P236 or P241.

In case of speed reference function is selected by P231 or P236 or P241 = 0 this reference is going to be a percentage of the maximum frequency(P134).

APPLICATION EXAMPLES

15.1.1 Application 1 - Nominal speed

This example describes an application where the analogic input signal corresponds to a frequency reference. The total excursion of analogic signal represents to command the motor to run from its minimum to maximum frequency as presented on [Figure 15.2 on page 15-2](#). [Table 15.1 on page 15-2](#) show parameters related to the correct setting.

Requirements:

- Motor: 1 HP, 220 V, 2.9 A, 1725 rpm, 60 Hz
- Min. Frequency = 0 Hz
- Max. Frequency = 60 Hz

Programming:

Table 15.1: Parameters for application 1

Analog Input	AI1	AI2	Potenciometer	Value
Min. Frequency	P133			0.0 Hz
Max. Frequency	P134			60.0 Hz
Max. Output Voltage	P142			100.0 %
Interm. Output Voltage	P143			50.0 %
Field Weak. Freq.	P145			60.0 Hz
Intermediate Freq.	P146			30.0 Hz
Selection source	P220			0
Reference source	P221 = 1	P221 = 2	P221 = 3	According application*
Rotation sel.	P223			0
Signal function	P231	P236	P241	0
Gain	P232	P237	P242	1.000
Input signal	P233	P238	-	According application**
Offset	P234	P239	P244	0 %

(*) Consult [Chapter 7 COMMAND AND REFERENCES on page 7-1](#).

(**) For AIx consult [Section 9.1 ANALOG INPUTS on page 9-1](#), for potentiometer this parameter is not available.

Example:

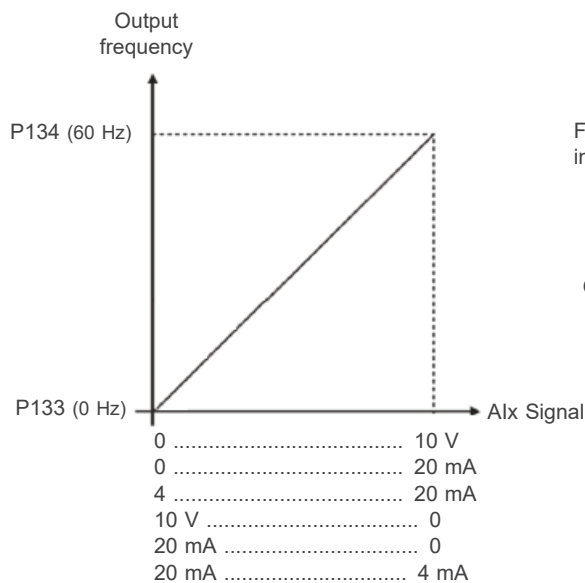

For AI1 set to 0-10 V (P233 = 0) and an analog input of 5 V:

$$P018 (\%) = \left(\frac{5 \text{ V}}{10 \text{ V}} \times (100.0 \%) + 0.0 \% \right) \times 1.000 = 50.0 \%$$

$$\text{Output Freq.} = P018 \times P134 = 50.0\% \times 60.0 \text{ Hz} = 30.0 \text{ Hz}$$

Figure 15.2: Result for application 1

15.1.2 Application 2 - Overspeed

This example describes an application where the analogic input signal corresponds to a frequency reference. The total excursion of analogic signal represents to command the motor to run from its minimum to maximum frequency as presented on Figure 15.3 on page 15-3. In this example, maximum speed is over the nominal speed (or field weakening speed). Table 15.2 on page 15-3 show parameters related to the correct setting.

Requirements:

- Motor: 1 HP, 220 V, 2.9 A, 1725 rpm, 60 Hz
- Min. Frequency = 0 Hz
- Max. Frequency = 80 Hz

Programming:

Table 15.2: Parameters for application 2

Analog Input	AI1	AI2	Potenciometer	Value
Min. Frequency		P133		0.0 Hz
Max. Frequency		P134		80.0 Hz
Max. Output Voltage		P142		100.0 %
Interm. Output Voltage		P143		50.0 %
Field Weak. Freq.		P145		60.0 Hz
Intermediate Freq.		P146		30.0 Hz
Selection source		P220		0
Reference source	P221 = 1	P221 = 2	P221 = 3	According application*
Rotation sel.		P223		0
Signal function	P231	P236	P241	0
Gain	P232	P237	P242	1.000
Input signal	P233	P238	-	According application**
Offset	P234	P239	P244	0 %

(*) Consult Chapter 7 COMMAND AND REFERENCES on page 7-1.

(**) For AIx consult Section 9.1 ANALOG INPUTS on page 9-1, for potentiometer this parameter is not available.

Example:

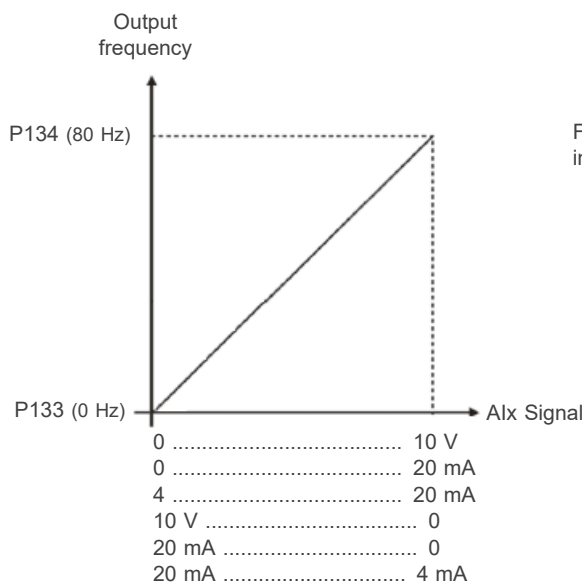

For AI1 set to 0-10 V (P233 = 0) and an analog input of 5 V:

$$P018 (\%) = \left(\frac{5 \text{ V}}{10 \text{ V}} \times (100.0 \%) + 0.0 \% \right) \times 1.000 = 50.0 \%$$

$$\text{Output Freq.} = P018 \times P134 = 50.0 \% \times 80.0 \text{ Hz} = 40.0 \text{ Hz}$$

Figure 15.3: Result for application 2

APPLICATION EXAMPLES

15.1.3 Application 3 - Forward/Reverse using Analog Input

This example describes an application where the analogic input signal corresponds to a frequency reference. The total excursion of analogic signal represents to command the motor to run from its minimum to maximum frequency, reversing the direction of rotation, as presented on [Figure 15.4 on page 15-4](#). [Table 15.3 on page 15-4](#) show parameters related to the correct setting.

Requirements:

- Motor: 1 HP, 220 V, 2.9 A, 1725 rpm, 60 Hz
- Min. Frequency = -60 Hz (Reverse)
- Max. Frequency = 60 Hz

Programming:

Table 15.3: Parameters for application 3

Analog Input	AI1	AI2	Potenciometer	Value
Min. Frequency		P133		0.0 Hz
Max. Frequency		P134		60.0 Hz
Max. Output Voltage		P142		100.0 %
Interm. Output Voltage		P143		50.0 %
Field Weak. Freq.		P145		60.0 Hz
Intermediate Freq.		P146		30.0 Hz
Selection source		P220		0
Reference source	P221 = 1	P221 = 2	P221 = 3	According application*
Rotation sel.		P223		0
Signal function	P231	P236	P241	0
Gain	P232	P237	P242	2.000
Input signal	P233	P238	-	According application**
Offset	P234	P239	P244	-50.0 %

(*) Consult [Chapter 7 COMMAND AND REFERENCES on page 7-1](#).

(**) For AIx consult [Section 9.1 ANALOG INPUTS on page 9-1](#), for potentiometer this parameter is not available.

Example:

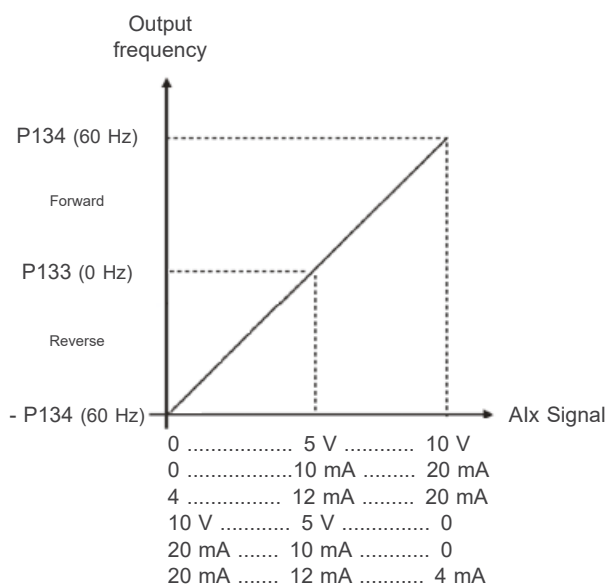

For AI1 set to 0-10 V (P233 = 0):

Analog input of 10 V:

$$P018 (\%) = \left(\frac{10 \text{ V}}{10 \text{ V}} \times (100.0 \%) + (-50.0 \%) \right) \times 2.000 = 100.0 \%$$

$$\text{Output Freq.} = P018 \times P134 = 100.0 \% \times 60.0 \text{ Hz} = 60.0 \text{ Hz}$$

Analog input of 5 V:

$$P018 (\%) = \left(\frac{5 \text{ V}}{10 \text{ V}} \times (100.0 \%) + (-50.0 \%) \right) \times 2.000 = 0.0 \%$$

$$\text{Output Freq.} = P018 \times P134 = 0.0 \% \times 60.0 \text{ Hz} = 0.0 \text{ Hz}$$

Analog input of 0 V:

$$P018 (\%) = \left(\frac{0 \text{ V}}{10 \text{ V}} \times (100.0 \%) + (-50.0 \%) \right) \times 2.000 = -100.0 \%$$

$$\text{Output Freq.} = P018 \times P134 = -100.0 \% \times 60.0 \text{ Hz} = -60.0 \text{ Hz}$$

Figure 15.4: Result for application 3

15.1.4 Application 4 - Analog input with dead zone

In this example, the output stay in 0 Hz through the first 2.5 V of analogic signal. The rotation of the motor (reverse) only happens if the Dead Zone parameter is disable (P230 = 0), as presented on Figure 15.5 on page 15-5. Table 15.4 on page 15-5 show parameters related to the correct setting.

Requirements:

- Motor: 1 HP, 220 V, 2.9 A, 1725 rpm, 60 Hz
- Min. Frequency = 0 Hz
- Max. Frequency = 45 Hz

Programming:

Table 15.4: Parameters for application 4

Analog Input	AI1	AI2	Potenciometer	Value
Min. Frequency		P133		0.0 Hz
Max. Frequency		P134		60.0 Hz
Max. Output Voltage		P142		100.0 %
Interm. Output Voltage		P143		50.0 %
Field Weak. Freq.		P145		60.0 Hz
Intermediate Freq.		P146		30.0 Hz
Selection source		P220		0
Reference source	P221 = 1	P221 = 2	P221 = 3	According application*
Rotation sel.		P223		0
Signal function	P231	P236	P241	0
Gain	P232	P237	P242	1.000
Input signal	P233	P238	-	According application**
Offset	P234	P239	P244	-25.0 %
Dead Zone**		P230		1

(*) Consult Chapter 7 COMMAND AND REFERENCES on page 7-1.

(**) For AIx consult Section 9.1 ANALOG INPUTS on page 9-1 , for potentiometer this parameter is not available.

Example:

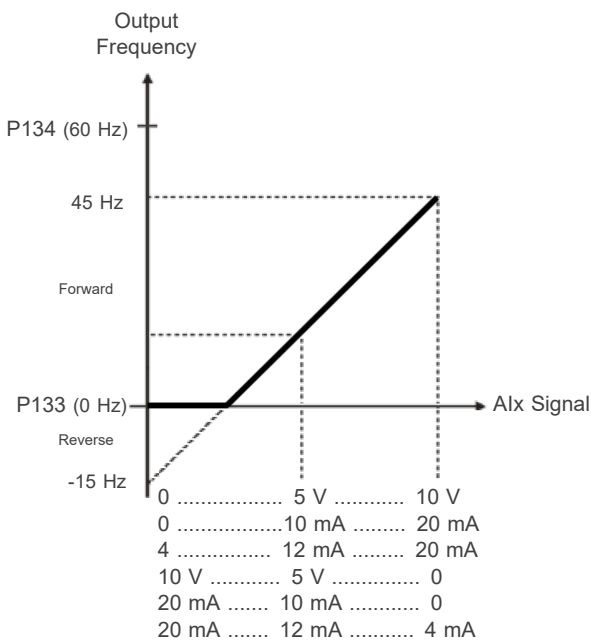

For AI1 set to 0-10 V (P233 = 0):

Analog input 10 V:

$$P018 (\%) = \left(\frac{10 \text{ V}}{10 \text{ V}} \times (100.0 \%) + (-25.0 \%) \right) \times 1.000 = 75.0 \%$$

$$\text{Output Freq.} = P018 \times P134 = 75.0 \% \times 60.0 \text{ Hz} = 45.0 \text{ Hz}$$

Analog input 2.5 V:

$$P018 (\%) = \left(\frac{2.5 \text{ V}}{10 \text{ V}} \times (100.0 \%) + (-25.0 \%) \right) \times 1.000 = 0.0 \%$$

$$\text{Output Freq.} = P018 \times P134 = 0.0 \% \times 60.0 \text{ Hz} = 0.0 \text{ Hz}$$

Analog input 0 V:

$$P018 (\%) = \left(\frac{0 \text{ V}}{10 \text{ V}} \times (100.0 \%) + (-25.0 \%) \right) \times 1.000 = -25.0 \%$$

$$\text{Output Freq.} = P018 \times P134 = -25.0 \% \times 60.0 \text{ Hz} = -15.0 \text{ Hz}$$

Figure 15.5: Result for application 4

APPLICATION EXAMPLES

15.1.5 Application 5 - Reverse reference with Analog input

This example describes an application where the analogic input signal corresponds to a frequency reference. The total excursion of analogic signal represents to command the motor to run from its minimum to maximum frequency as presented on Figure 15.6 on page 15-6. Here the analog input is inverted when compared to Application 1. Table 15.5 on page 15-6 show parameters related to the correct setting.

Requirements:

- Motor: 1 HP, 220 V, 2.9 A, 1725 rpm, 60 Hz
- Min. Frequency = 0 Hz
- Max. Frequency = 60 Hz

Programming:

Table 15.5: Parameters for application 5

Analog Input	AI1	AI2	Potenciometer	Value
Min. Frequency		P133		0.0 Hz
Max. Frequency		P134		60.0 Hz
Max. Output Voltage		P142		100.0 %
Interm. Output Voltage		P143		50.0 %
Field Weak. Freq.		P145		60.0 Hz
Intermediate Freq.		P146		30.0 Hz
Selection source		P220		0
Reference source	P221 = 1	P221 = 2	P221 = 3	According application*
Rotation sel.	P223 = 0	P223 = 0	P223 = 1	According application
Signal function	P231	P236	P241	0
Gain	P232	P237	P242	1.000
Input signal	P233	P238	-	2
Offset	P234 = 0 %	P239 = 0 %	P244 = -100.0 %	According application**

(*) Consult Chapter 7 COMMAND AND REFERENCES on page 7-1.

(**) For AIx consult Section 9.1 ANALOG INPUTS on page 9-1 , for potentiometer this parameter is not available.

Example:

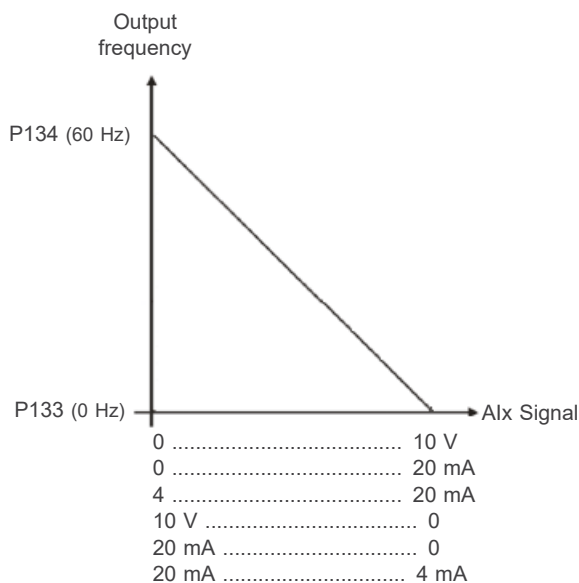

For AI1 set to 10-0 V (P233 = 2) and an analog input of 7.5 V:

$$P018 (\%) = 100.0 \% - \left(\frac{7.5 \text{ V}}{10 \text{ V}} \times (100.0 \%) + 0.0 \% \right) \times 1.000 = 25.0 \%$$

$$\text{Output Freq.} = P018 \times P134 = 25.0 \% \times 60.0 \text{ Hz} = 15.0 \text{ Hz}$$

For potentiometer accessory with an analog input of 7.5 V one need P244 = -100.0 % and P223 = 1:

$$P018 (\%) = \left(\frac{7.5 \text{ V}}{10 \text{ V}} \times (-100.0 \%) + 0.0 \% \right) \times 1.000 = -25.0 \%$$

$$\text{Output Freq.} = P018 \times P134 = -25.0 \% \times 60.0 \text{ Hz} = -15.0 \text{ Hz}$$

Figure 15.6: Result for application 5

15.2 PID CONTROLLER APPLICATION

This example describes an application controlling a process in closed loop (PID Controller), as presented in Figure 15.7 on page 15-7. Table 15.6 on page 15-7 show parameters related to the correct setting.

Requirements:

- The frequency inverter will be configured to operate in the local mode.
- Digital input DI1 will be used for the Run/Stop command in local mode.
- Digital input DI2 will be used to select the PID to Manual/Automatic.
- The PID controller process variable (PV) will be connected to analog input AI1 in the scale of 4-20 mA, where 4 mA is equal to 0 bar (P922) and 20 mA is equal to 4.0 bar (P923).
- The PID controller control setpoint (SP) will be via HMI (keys).

Example:

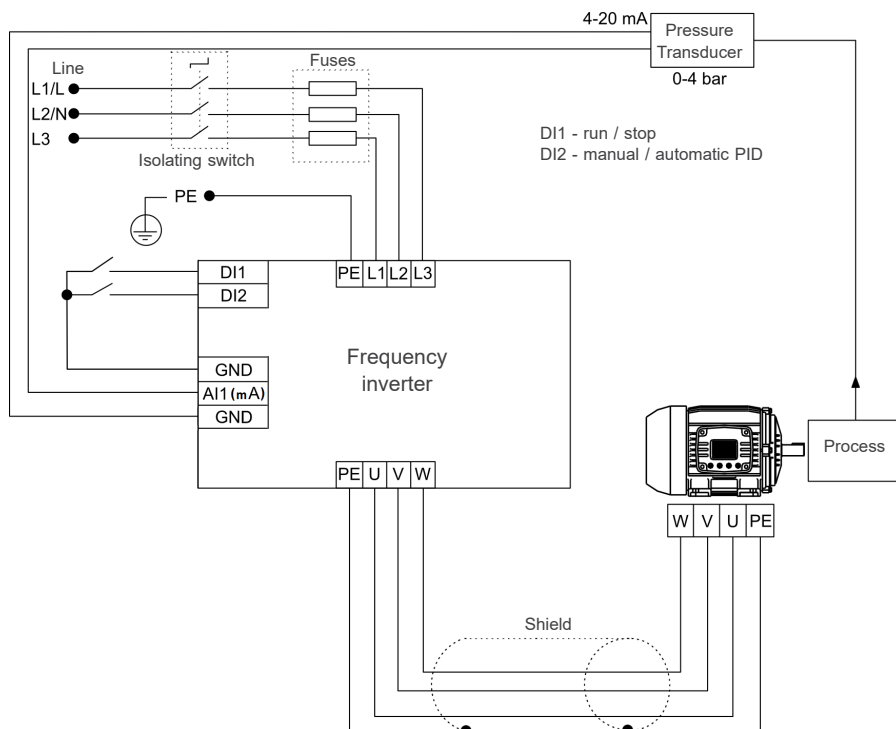

Figure 15.7: Example of the PID controller application

Programming:

Table 15.6: Programming sequence of the PID controller application

Sequence	Setting	Action / Result
P903	1 = PID Controller	It selects the PID controller application in the SoftPLC function of the inverter
P901	1 = Run Application	It enables the execution of the PID controller application
P928	1 = Direct	It selects the PID controller control action, thus enabling its operation and uploading, at this moment the application default setting*
P133	40.0 Hz	Minimum frequency
P134	60.0 Hz	Maximum frequency
P233	1 = 4 to 20 mA	Selection of the AI1 Signal Function
P911	2.00	Setting of the control Setpoint via HMI
P931	1.00	Proportional Gain of the PID controller
P932	5.00	Integral Gain of the PID controller
P933	0.00	Derivative Gain of the PID controller

(*) Consult Table 14.2 on page 14-4.



BRAZIL

WEG DRIVES & CONTROLS - AUTOMAÇÃO LTDA.

Av. Prefeito Waldemar Grubba, 3000

89256-900 - Jaraguá do Sul - SC

Phone: 55 (47) 3276-4000

Fax: 55 (47) 3276-4060

www.weg.net/br