

W12

Technical Catalogue

Industrial Motors

Commercial &
Appliance Motors

Automation

Digital &
Systems

Energy

Transmission &
Distribution

Coatings

Single-phase European Market

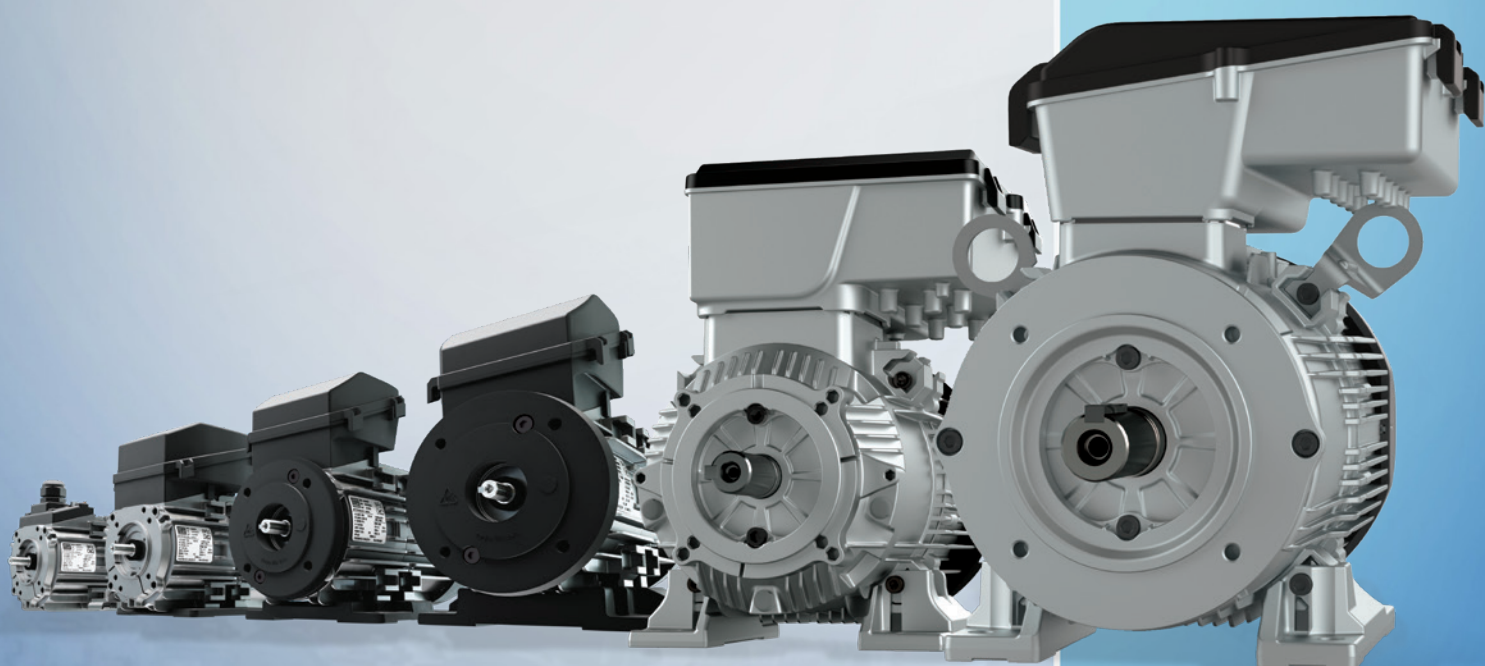

Driving efficiency and sustainability



Index

1. Available versions.....	3
2. Standards.....	3
3. Constructive Details.....	3
3.1. Frame.....	3
3.2. Lifting.....	3
3.3. Feet.....	3
3.4. Terminal Box.....	4
3.5. Grounding Terminals.....	4
3.6. Connecting the Cables Connection.....	5
3.7. Identification Label.....	5
3.8. Flange.....	5
3.9. Drains.....	6
3.10. Fan Cover.....	6
3.11. Canopy.....	7
4. Ventilation / Noise / Vibration.....	7
4.1. Ventilation system.....	7
4.2. Noise level.....	7
4.3. Vibration Levels.....	7
5. Shaft / Bearings.....	7
5.1. Shaft.....	7
5.2. Bearings.....	7
5.3. Loads.....	8
6. Degree of protection / Sealing.....	8
7. Corrosion protection.....	8
8. Mounting.....	9
9. Voltage / frequency.....	9
14. Construction Features.....	10
10. Ambient & Insulation.....	10
11. Motor Thermal Protection.....	10
11.1. Minimum distance from the wall.....	10
12. Tolerances for Electrical Data.....	10
13. Packing.....	10
15. Optional Features.....	11
16. Electrical Data.....	12
16.1 W12 Single-phase - Permanent Capacitor - 50 Hz.....	12
16.2 W12 IE2 Single-phase - Permanent Capacitor - 50 Hz.....	13
17. Mechanical Data.....	14
17.1 Single-phase foot mounted motors.....	14
17.2 C-DIN Flange.....	15
17.3 FF Flange	15

1 . Available versions

W12 motors are asynchronous squirrel cage, fully enclosed single-phase, low voltage.

2 . Standards

Standard	Descriptive
IEC EN 60034-1	Rotating electrical machines – Part 1: Rating and performance
IEC 60034-2-1	Rotating electrical machines – Part 2-1: Standard methods for determining losses and efficiency from tests (excluding machines for traction vehicles)
IEC 60034-5	Rotating electrical machines - Part 5: Degrees of protection provided by the integral design of rotating electrical machines (IP code) - Classification
IEC 60034-6	Rotating electrical machines - Part 6: Methods of cooling (IC Code)
IEC 60034-7	Rotating electrical machines – Part 7: Part 7: Classification of types of construction, mounting arrangements and terminal box position (IM Code)
IEC 60034-8	Rotating electrical machines - Part 8: Terminal markings and direction of rotation
IEC 60034-9	Rotating electrical machines – Part 9: Noise limits
IEC 60034-11	Rotating electrical machines – Part 11: Thermal protection
IEC 60034-12	Rotating electrical machines – Part 12: Starting performance of single-speed three-phase cage induction motors
IEC 60034-14	Rotating electrical machines – Part 14: Mechanical vibration of certain machines with shaft heights 56 mm and higher - Measurement, evaluation and limits of vibration
IEC 60034-30-1	Rotating electrical machines - Part 30-1: Efficiency classes of line operated ac motors (IE code)
IEC 60038	IEC standard voltages
IEC 60072-1	Dimensions and output series for rotating electrical machines. Part 1: Frame numbers 56 to 400 and flange numbers 55 to 1080
IEC 62262	Degrees of Protection Provided by Enclosures for Electrical Equipment Against External Mechanical Impacts (IK CODE)

Table 1 - Standards

3 . Constructive Details

3.1 Frame

The aluminum frame of the W12 motors (Figure 1) is designed to optimize the heat exchange and provide mechanical strength to meet the most critical applications. Its design reduces the accumulation of liquids and dust on the motor. The frame also has guides to ensure the accuracy and rigidity of the assembly after mounting the feet or flanges.

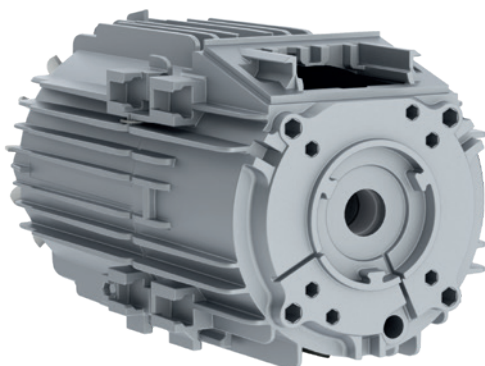

Figure 1 - W12 Frame

3.2 Lifting

W12 motors must be lifted by means of the aluminum frame, flange or foot.

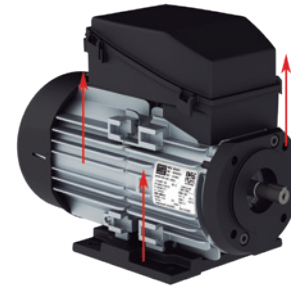

Figure 2 - Points for lifting W12 motors

3.3 Feet

W12 motors, in the frames IEC56/W63/W71 are supplied with a polymeric feet, and for the frames 71/W80/90/W100 are supplied with aluminum feet.

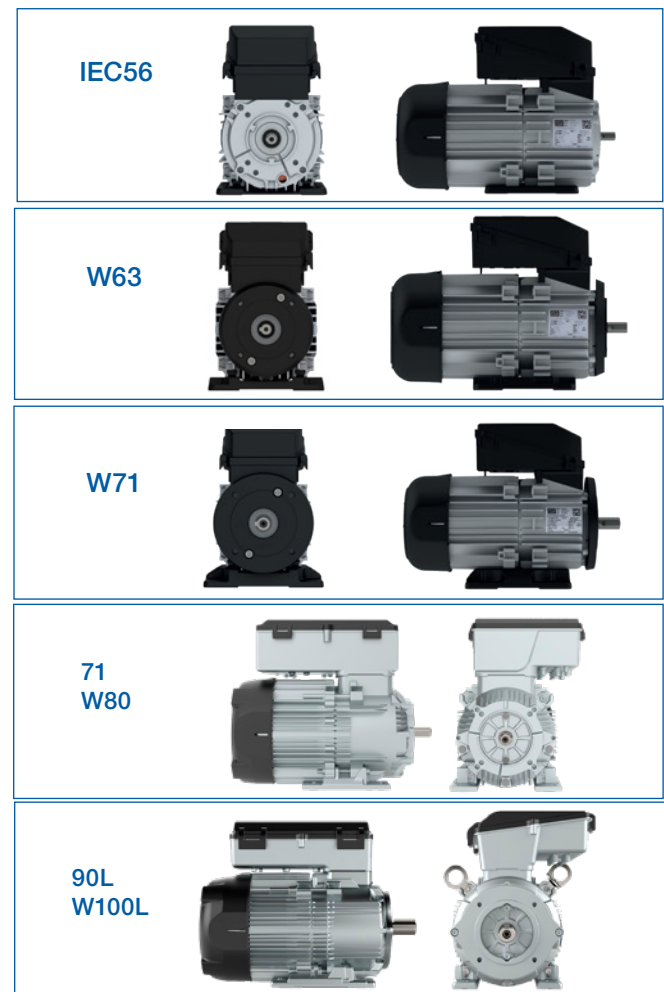

Figure 3 - W12 frame sizes.

For fixing the motor by the foot in the application, the maximum length of the screws must meet the values in Table 2. It is recommended to use a washer to fix the screw.

Frame	Maximum screw length
IEC56	M5x16mm
W63	M5x16mm
W71	M6x16mm
71	M6x20mm
W80	M8x25mm
90	
W100	M10x30mm

Table 2 - Maximum length of the fixing screws.

Note: When the motor is used in a vertical mounting manner with the shaft up and fixed by the foot, the foot must be locked in the axial direction with a countersunk screw with a M5x0.8 thread with a length of 16 mm (W63 and W71) or 12 mm (IEC56).

3.4 Terminal Box

The terminal boxes and covers of the terminal boxes of the W12 IEC56/W63/W71 motors are made of high-strength industrial polymer and for the frames 71/W80/90L/W100L are supplied with aluminum. The terminal box for single-phase motors allows the capacitor housing. The W12 motors can also be supplied without a terminal box, in this case, there will be a "hub" (base) for the output of the power cables, which is ideal for applications where the motor is housed in the ventilation duct, thus increasing the air passage area. Contact us for motors with "hub" (base) mounting.

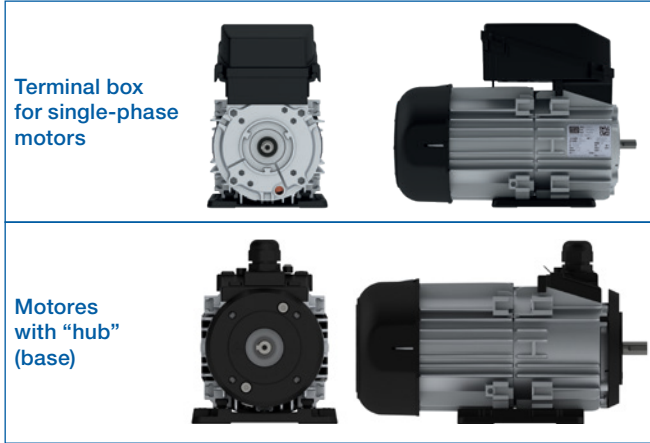

Figure 4 - Terminal box and hub base models

To guarantee the degree of protection, the set is supplied with rubber gaskets between the frame and the terminal box and between the terminal box and the terminal box cover. The terminal box cover and the terminal box are fixed using the Snap Fit quick coupling system, which adds rigidity to the assembly. When assembling the components, it is possible to hear a "click" sound signaling that it is in the correct position.



Figure 5 - Assembly of the terminal box

The terminal box cover can have extra fixation, in this case, the self-tapping screw for polymer with a dimension of 2.9x13 mm.

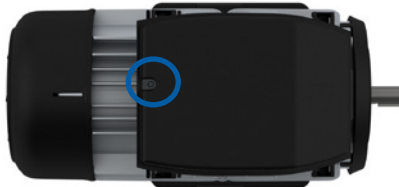

Figure 6 - Extra fastening of the terminal box cover

For the frames 71/W80, 90L and W100L, the terminal box cover also has an extra fixation possibility. It's allowed to use M5x0,8 into 16mm length screws on the hexagonal holes.



Figure 7 - Extra fixation 71/W80, 90L and W100L

The cable entry of the terminal boxes of the W12 motors is always facing the side of the fan cover, regardless of the constructive form of the motor, facilitating and speeding the installation of the cable gland.

The hole size is 22.4 mm, which allows the use of M20, NPT 1/2" cable glands or similar, with counter nut without flange. Terminal boxes are provided with plastic plugs at the cable entry to protect against the entry of solid objects during transport. Hub base motors are supplied with M20 gauge cable glands.

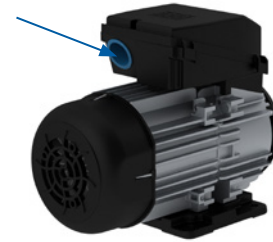

Figure 8 - W12 motor terminal box cable entry

The terminal boxes of W12 motors, 71, W80, 90L and W100L frames, are made of injected aluminum. The capacitor used in the single phase motors can have the maximum dimensions of 46mm diameter into 94mm length (2 capacitors for the 71, W80 frames and 3 capacitors for the 90L, W100L frames). The cable outlet ports are closed, the knockout system allows the usage of M20 and M25 or similar cable gland size.

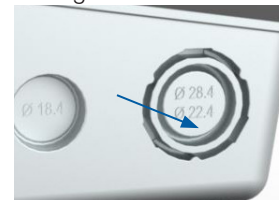

Figure 9 - W12 motor terminal box knockout.

The distance between the terminal box and the "DF" pulley shoulder is shown in Table 3.

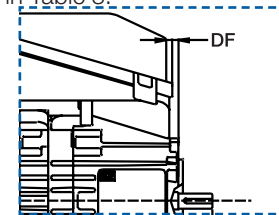

Figure 10 - Distance between the terminal box and the pulley shoulder - Dimension DF

Flange	Distance between terminal box and pulley shoulder "DF"	
	Hub base	Terminal box
C-80	5,7	3,9
C-90 and C-105	14,5	12,7
FF-115		
FF-130	24,5	22,7
FF-165		
C-105		
C-120	24,4	17,3
C-140 and C-160		

Table 3 - Distance from the "DF" pulley terminal box

3.5 Grounding Terminals

As standard, W12 motors are supplied with a connector 6.3 grounding terminal mounted inside the for IEC56/W63/W71 frames.

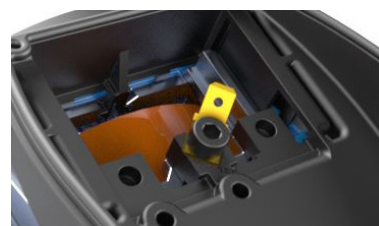

Figure 11 - Grounding terminal inside the terminal box

For 71, W80, 90L and W100L grounding used is a screw plus a washer.



Figure 12 - Grounding terminal 71,W80,90L and W100L the terminal box
Motor power supply leads are marked in accordance with IEC 60034-8 and are connected to a terminal block made from a polyester based resin BMC (Bulk Moulding Compound), duly reinforced with fibre glass.

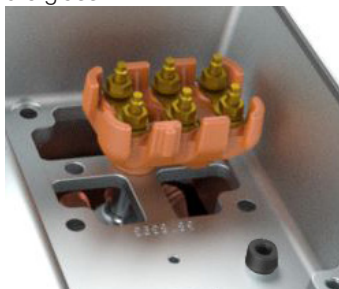

Figure 13 - BMC terminal block with 6-pins

NOTE: Incorrect sizing of the grounding terminals can cause serious damage to the equipment and people involved in the operation of the motor. Before energizing the motor, ensure that the motor is properly grounded and that all grounding components are in perfect working condition.

When the hub is used, as optional, the grounding is located on hub, as shown below.



Figure 14 - Hub grounding polymeric



Figure 15 - Hub grounding aluminum

3.6 Connecting the Cables Connection

The connection and accessory cables are connected to the terminal box. The terminal box cover is provided with the motor connection diagram, the diagram to be used is indicated on the motor identification label. Motors with hub base, are provided with a unique label for the wiring diagram.

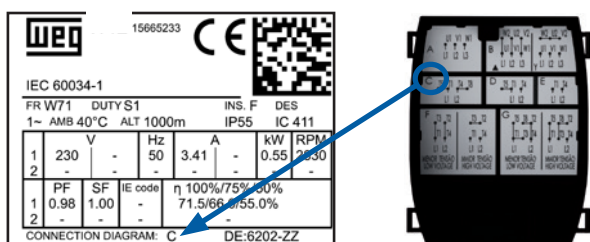

Figure 16 - Diagram of the connection cable connection

3.7 Identification Label

The identification label contains the information of the construction characteristics and the performance of the motors according to IEC 60034-1.

The W12 motors are supplied with a main identification nameplate, which contains the motor performance data in accordance with the regulatory standards in each country (IEC-60034-1, NBR 17094-1).

The dimensions of the nameplate are 30x40mm for frames IEC56/W63/W71, and 60x60mm for frames 71/W80, 90L/W100L. The nameplate layout is according to the picture below:

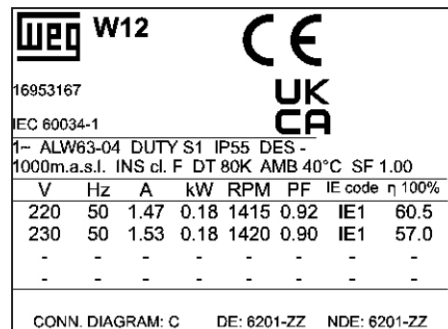

WEG W12		CE	
16953167		UK	
IEC 60034-1		CA	
1~ ALW63-04 DUTY S1 IP55 DES -			
1000m.a.s.l. INS cl. F DT 80K AMB 40°C SF 1.00			
V	Hz	A	kW RPM PF IE code η 100%
220	50	1.47	0.18 1415 0.92 IE1 60.5
230	50	1.53	0.18 1420 0.90 IE1 57.0
-	-	-	- - - -
CONN. DIAGRAM: C		DE: 6201-ZZ NDE: 6201-ZZ	

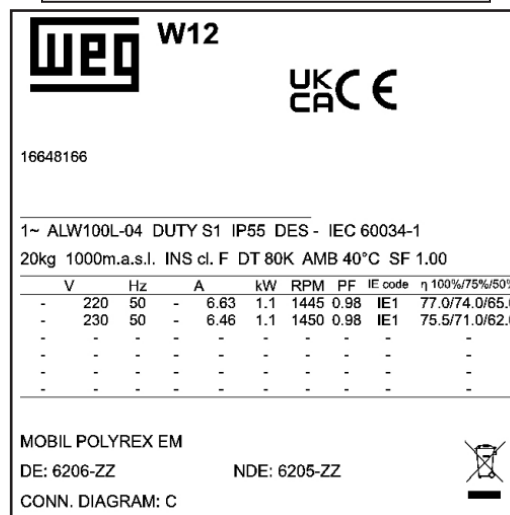

WEG W12		UK	
16648166		CA	
CE			
1~ ALW100L-04 DUTY S1 IP55 DES - IEC 60034-1			
20kg 1000m.a.s.l. INS cl. F DT 80K AMB 40°C SF 1.00			
V	Hz	A	kW RPM PF IE code η 100%/75%/50%
-	220 50	-	6.63 1.1 1445 0.98 IE1 77.0/74.0/65.0
-	230 50	-	6.46 1.1 1450 0.98 IE1 75.5/71.0/62.0
-	-	-	- - - -
-	-	-	- - - -
MOBIL POLYREX EM			
DE: 6206-ZZ		NDE: 6205-ZZ	
CONN. DIAGRAM: C			

Figure 17 - Nameplate W12 Motor

W12 motors can be supplied with additional labels on request. Figure 12 shows the position of the identification labels on the W12 motors.

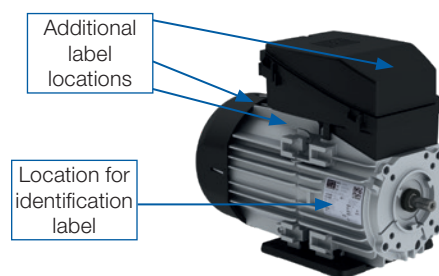

Figure 18 - Location of labels on W12 motors.

3.8 Flange

W12 motors are supplied with a standard C-DIN flange for each frame size. The FF-115 flange is available as an optional from the W63 frame.

The dimensions of the flanges are available in the chapter of mechanical data.

The C-90, C-105 and FF-115 flanges are supplied in highstrength industrial polymer, which, in addition to excellent mechanical properties, withstands temperature conditions of up to 120 ° C, that is, it is able to withstand the conditions of operation of the W12 motor.

Screws used directly in the hexagonal holes of the frame must have class 8.8 (ISO 898/1) or higher, and a cemented finish or better.

The maximum flange runout values for W12 motors are specified in Table 4.

Frame	Flange Material	Runout	Maximum (mm)
IEC56, W63 and W71	Aluminum	Radial	0,18
		Axial	0,11
	Polymeric	Radial	0,50
		Axial	0,90
71,W80,90L,W100L	Aluminum machined	Radial	0,1
		Axial	0,1

Table 4 - Maximum radial and axial runout of the flanges

Flange C-DIN

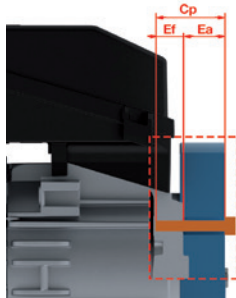

Figure 19 - Maximum threaded hole length

Frame IEC56/W63/W71			
	Flange thickness Ef (mm)	Coupling thickness Ea (mm)	Screw length Cp (mm)
C-80	10	2	12
		4	14
		6	16
		8	18
		10	20
		x	$Y = 9 + x \text{ to } 10 + x$
C-90	8	2	10
		4	12
		6	14
		8	16
		10	18
		x	$Y = 7,5 + x \text{ to } 8,5 + x$
C-105	9	6	25
		11	30
		16	35
		21	40
		26	45
		x	$Y = 18 + x \text{ to } 19 + x$
Frame 71/W80			
C-105 C-120	12	2	14
		4	16
		8	20
		10	22
		12	24
		14	26
Frame 90L/W100L			
C-140 C-160	16	2	18
		4	20
		8	24
		10	26
		12	28
		14	30

Table 5 - Screw length for C-DIN flange

Flange FF

The FF-115 flange is fixed directly to the aluminum frame, has holes to fix the coupling directly to the application. The tightening torque to be applied is 8 Nm.

The FF-115 flange ensures interchangeability with existing applications.

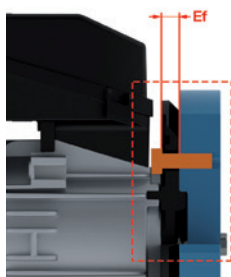

Figure 20 - FF-115 flange thickness

Frame IEC56/W63/W71			
	Flange thickness Ef (mm)	Coupling thickness Ea (mm)	Screw length Cp (mm)
FF-115	7	13	20
		18	25
		23	30
		28	35
		33	40
		38	45
Frame 71/W80			
FF-130 FF-165	9	13	22
		18	27
		23	32
		28	37
		33	42
		28	47
Frame 90L/W100L			
FF-165 FF-215	10,2	13	23
		18	28
		23	33
		28	38
		33	43
		38	48

Table 6 - Screw length for FF flange

3.9 Drains

The drainage system prevents the accumulation of condensed water and the entry of unwanted substances into the motor and us prevents corrosion or damage to internal components. The W12 motors are supplied with an automatic drain that meet all mounting, thus avoiding the need for user intervention during the period of operation of the motor. For vertical mounting with the shaft up, there are drains on the flange that prevent the accumulation of liquids.

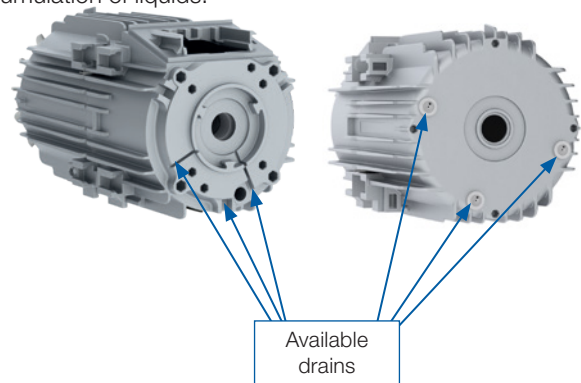

Figure 21 - W12 motor drains

3.10 Fan Cover

The fan covers are made of high-strength industrial polymer, which guarantees high mechanical rigidity and high impact absorption capacity. They comply with the IK08 impact index, according to EN 62262, which guarantees use in more severe applications.

The fan cover is fixed to the housing using the Snap Fit system, which ensures easy assembly of the assembly.



Figure 22 - Fixing the fan cover to the frame

3.11 Canopy

For motors installed in open environments or in vertical applications with shaft ends downwards, the use of additional protection (canopy) is recommended to prevent liquids and / or solid particles from entering the motor. The use of canopy motor causes the increase in the total motor length (L). Table 8 shows this dimension.

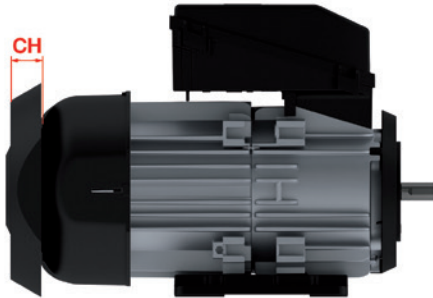

Figure 23 - Motor with canopy

Frame	CH dimension [increase in motor length L (mm)]
IEC56	22
W63	
W71	
71	25
W80	
90L	
W100L	30

Table 7 - W12 motor length with canopy

4 . Ventilation / Noise / Vibration

4.1 Ventilation system

The W12 motors are totally enclosed fan cooled (TEFC) IC 411, according to the IEC 60034-6 standard. The set of the fan cover, fan and finned housing guarantee the best thermal dissipation of the motor, directing the air flow efficiently, thus allowing the motor to reach the best possible energy efficiency level for the project.

4.2 Noise level

The W12 motors meet the IEC 60034-9 sound power levels. Table 9 shows the sound pressure levels in the dB (A) scale obtained experimentally for the W12 motors, at 50 Hz, with sinusoidal supply.

Frame	Sound pressure level - dB (A) - 50 Hz	
	2 Poles	4 Poles
IEC56	55	47
W63	55	47
W71	55	47
71	56	47
W80	56	47
90L	62	49
W100L	62	49

Table 8 - Sound pressure level for 50 Hz motors

4.3 Vibration Levels

The vibration of an electric motor in operation is very dependent on the conditions of the installation. In this way, it is extremely important that the customer ensures a foundation rigid and with dimensional tolerances. Other important information can be found in the topic Installation Features.

To avoid damaging the equipment, vibration levels should be monitored periodically and any abnormal behavior should be reported immediately to the nearest WEG assistance and / or WEG. Motors with rolling bearings are extremely sensitive to vibrations, and can suffer premature wear if subjected to vibrations outside the limits acceptable in standards. Permissible vibration amplitudes, as reference from three-phase motors defined by IEC 60034-14, in vacuum (decoupled), are classified in levels of intensity A and B, as in table 9:

Vibration	Assembly	Displacement [µm]	Velocity [mm/s]	Acceleration [m/s ²]
Grade A	Elastic base	45	2.8	4.4
	Rigid Base	37	2.3	3.6
Grade B	Elastic base	29	1.8	2.8
	Rigid Base	24	1.5	2.4

Table 9 - Vibration speed levels

5 . Shaft / Bearings

5.1 Shaft

As standard, all W12 motors are manufactured in SAE 1040/45 steel and supplied with type A key. The W12 motor shafts can optionally be supplied with a threaded hole in the shaft end according to DIN 332. Special dimensions, double shaft end and other materials only on request. The maximum allowed runout on the shaft is for IEC56/W63/W71 and 0,040mm to 71, W80, 90L and W100L. For special cases, consult WEG.

5.2 Bearings

The service life of the bearing depends on the type and size of the bearing, the radial and axial mechanical loads it is subjected to, the operating conditions (environment, temperature), the rotation and the life of the grease. Thus, the bearing's service life is strictly related to its correct use and maintenance.

W12 motors do not require intervention for relubrication during the bearing's service life, since they have shielding that ensures lubrication throughout the bearing's life cycle.

The service life of the W12 motor bearings is L10h of 20,000 hours, provided that the maximum radial or axial loads described in Table 13, Table 14 and Table 15 are respected. When directly coupled to the load (no radial and axial forces) in the horizontal position, the bearings have an L10h service life of 40,000 hours.

Vertical motors have a 20% reduction in the values indicated for bearings in the horizontal position. Different lifetime values can be provided upon request. Standard bearings for the W12 line are shown in Table 11.

Frame	Poles	DE Bearing	NDE Bearing
IEC56	2-6	6201	6201
W63	2-6	6201	6201
W71	2-6	6202	6201
71	2-6	6203	6202
W80	2-6	6204	6202
90L	2-6	6205	6205
W100L	2-6	6206	6205

Table 10 - Standard bearings for the W12

Notes:

1 - L10 service life means that at least 90% of the bearings subjected to the maximum loads indicated will reach the number of hours reported. The maximum radial load values consider zero axial load. Maximum axial load values consider zero radial load. For bearing life in applications with axial and radial load combinations, contact WEG.

2 - The value of the radial force F_r is usually obtained from information recommended in catalogs of belt / pulley manufacturers. In the absence of an estimate from the belt manufacturer, the force F_r , in the operating condition, can be calculated according to the transmitted power, the dimensional characteristics of the pulley coupling, the belts and the type of application. Like this,

$$F_r = 19,1 \times 10^6 \times P_n \times k_a \text{ (N)}$$

$$n \times d_p$$

Where:

F_r = the radial force generated by the coupling of pulleys and belts [N];

P_n = the rated motor power [kW];

nn = the rated engine speed in revolutions per minute [rpm];

d_p = the primitive diameter of the motor pulley [mm];

k_a = a factor that depends on the belt tension and the type of application.

Basic Groups and Types of Application		Application ka factor	
		Trapezoidal Belts (V)	Belts Flat Planes
1	(Fans, Exhaust Fans, Centrifugal Pumps, Winders, Centrifugal Compressors, Operating Machines) with powers up to 30 HP (22 kW).	2,0	3,1
2	(Fans, Exhaust Fans, Centrifugal Pumps, Winders, Centrifugal Compressors, Operating Machines) with powers greater than 30 HP (22 kW), Mixers, Punches, Shears, Graphic Machines.	2,4	3,3
3	Presses, Oscillating Sieves, Piston and Screw Compressors, Sprayers, Helical Conveyors, Wood Tilling Machines, Textile Machines, Mug Elevators, Kneaders, Ceramic Machines, Grinders for the Paper Industry.	2,7	3,4
4	Overhead Cranes, Hammer Mills, Metal Laminators, Continuous Conveyors, Rotary Crushers, Jaw Crushers, Roller and Cone Crushers, Roller and Ball Mills, Pestle Mills, Rubber Mixers, Mining Machines, Scrap Chippers.	3,0	3,7

Table 11 - Ka factor for groups and basic types of application

Notes:

- 1 - Special applications
Operation in conditions other than normal, such as ambient temperature, altitude. Axial and / or radial loads above those indicated in the tables in this catalog imply specific lubrication intervals, different from those shown here.
- 2 - Motors driven by frequency inverter
Bearing life may be shortened when the motor is driven by a frequency inverter at speeds above the nominal. Rotation is one of the criteria used to define the bearing life.
- 3 - Values for radial efforts
The values shown in Table 13 for the radial forces consider the points of application of the force in the middle of the L/2 shaft end or at the end of the L shaft end.

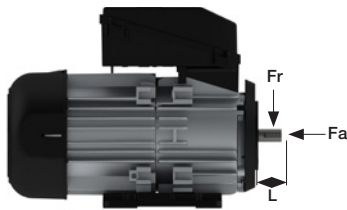

Figure 24 - Radial and axial force on the motor shaft

5.3 Loads

To determine the permissible radial and axial loads, the input data are considered:

- 1 - Normal operating conditions
- 2 - Shaft material Carbon steel SAE 1040/45
- 3 - 2-pole motors: Parabolic torque load (fans, exhaust fans, pumps and centrifugal compressors).
- 4 - 4-pole motors: Constant torque load (piston pumps and compressors, cranes, crushers)

The values consider the application of a standard bearing.

Allowable Radial Loads

Frame	Maximum Radial Load Fr (N)					
	2 Poles		4 Poles		6 Poles	
	L/2	L	L/2	L	L/2	L
IEC56	240	200	200	160	190	130
W63	260	210	220	170	200	140
W71	290	230	240	180	210	150
71	420	390	600	450	600	440
W80	630	580	660	440	970	780
90L	640	580	870	800	-	-
W100L	1000	910	1250	1110	-	-

Table 12 - Maximum radial forces for ball bearings (zero axial force)

Allowable Axial Loads

Frame	Poles	Shaft End Axial Load - Fa (N)	
		Compression (N)	Traction (N)
IEC56	2	140	380
	4	270	510
	6	340	580
W63	2	140	380
	4	270	510
	6	340	580
W71	2	140	440
	4	240	540
	6	310	610
71	2	150	490
	4	250	590
	6	340	680
W80	2	110	510
	4	210	610
	6	300	700
90L	2	370	870
	4	570	1,080
W100L	2	310	910
	4	1,110	510

Table 13 - Maximum axial forces for horizontal mounting

Frame	Poles	Shaft end Axial Load - Vertical - Fa (N)			
		Upwards shaft		Downwards shaft	
		Traction	Compression	Traction	Compression
IEC56	2	420	160	400	180
	4	530	250	490	290
	6	600	330	570	360
W63	2	420	160	400	180
	4	530	250	490	290
	6	600	330	570	360
W71	2	450	130	430	150
	4	560	220	520	260
	6	630	300	600	330
71	2	510	130	470	170
	4	640	220	560	300
	6	730	300	640	390
W80	2	570	070	470	170
	4	680	170	570	280
	6	760	270	670	360
90L	2	940	320	820	440
	4	1,150	520	1,030	650
W100L	2	1,030	230	830	430
	4	1,240	430	1,030	630

Table 14 - Maximum axial forces for vertical mounting

6 . Degree of protection / Sealing























The W12 motors are supplied with a V'Ring sealing on the DE bearing, meeting the IP55 degree of protection as standard. As an option, W12 motors can be supplied without sealing, meeting IP54 degree of protection.

7 . Corrosion protection

W12 motors are supplied unpainted. Its components are manufactured in aluminum or industrial polymer of high resistance, which are materials that resist conditions of closed or open environments, with the presence of SO₂, vapors and solid contaminants, high humidity, splashes of alkaline substances and solvents.

8 . Mounting

Motors are supplied, as standard, in the B14T configuration for IEC56/W63/W71 frames, B34T for 71 and B3T for W80, 90L and W100L frames. The mounting configuration for the W12 motor lines comply with IEC 60034-7 standard, Code I Tables 1 (horizontal mounted motors) and 2 (vertical mound motors). After the code, a characteristic letter is used to define the terminal box position, according to the WEG designation (position of the driven side, looking at the connection box).

Mounting	Configuration								
	Reference	B14T ³	B34D	B34E	B34T	B35D	B35E	B35T	B3D
Details	Frame	Without feet	With feet	With feet	With feet	With feet	With feet	With feet	With feet
	Shaft end	On the right	On the right	On the left	On the right	On the right	On the left	On the right	On the right
	Fixation	C Flange	Base or C Flange	Base or C Flange	Base or C Flange	Base or FF Flange	Base or FF Flange	Base or FF Flange	Base or Rails
Mounting	Configuration								
	Reference	B3E	B3T	B5D	B5E	B5T	V1 ¹	V18	V19 ²
Details	Frame	With feet	With feet	Without feet	Without feet	Without feet	Without feet	Without feet	Without feet
	Shaft end	On the left	On the right	On the right	On the left	On the right	Downward	Downward	Upward
	Fixation	Base or Rails	Base or Rails	FF Flange	FF Flange	FF Flange	FF Flange	C Flange	C Flange
Mounting	Configuration								
	Reference	V3 ²	V36D ^{2,4}	V36E ^{2,4}	V36T ^{2,4}	V6D ^{2,4}	V6E ^{2,4}	V6T ^{2,4}	
Details	Frame	Without feet	With feet	With feet	With feet	With feet	With feet	With feet	
	Shaft end	Upward	Upward	Upward	Upward	Upward	Upward	Upward	
	Fixation	FF Flange	Wall or FF Flange	Wall or FF Flange	Wall or FF Flange	Wall	Wall	Wall	

Notes:

1 - For motors mounted vertically shaft down, is recommended the use of drip cover to prevent ingress of small objects into the fan cover / fan.

2 - For motors mounted vertically with shaft up and installed in environments containing liquids, the use of a rubber slinger is recommended to prevent the ingress of liquid into the motor through the shaft.

3 - The mounting B14, allows the rotation of the motor for installation in the B14T, B14D and B14E configurations.

4 - For motors mounted vertically with shaft up and fixed by the foot, the foot must be locked in the axial direction with a countersunk screw with a M5x0.8 thread with a length of 16 mm (W63 and W71) or 12 mm (IEC56)

The possible combinations of mounting per frame are available in Table 15.

Mounting	Frame						
	IEC56	W63	W71	71	W80	90L	W100
B14T*	S	S	S	0	0	0	0
B34D / B34E	NA	0	0	0	0	0	0
B34T	0	0	0	S	0	0	0
B35D / B35E / B35T	NA	0	0	0	0	0	0
B3D / B3E	NA	0	0	NA	0	0	0
B3T	NA	0	0	NA	S	S	S

Mounting	Frame						
	IEC56	W63	W71	71	W80	90L	W100
B5T*	NA	0	NA	0	0	0	0
V1 / V3	NA	0	NA	0	0	0	0
V18 / V19	0	0	0	0	0	0	0
V36D / V36E / V36T	NA	0	NA	0	0	0	0
V6D / V6E / V6T	NA	0	0	NA	0	0	0

Table 15 - Mounting forms available per frame

Where:

S - Standard

0 - Optional

NA - Not Available

* Footless motors can be rotated to suit the B5 and B14 mounting with terminal box at the top (T), right (D) or left (E). Voltage / Frequency

9 . Voltage / frequency

As defined in IEC 60034-1 the combination of voltage and frequency variations are classified as Zone A or Zone B, figure 21.

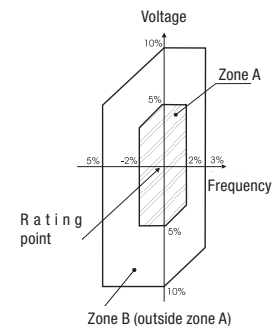

Figure 25 - Rated voltage and frequency limits for electric motors

IEC 60034-1 states that the motor must be suitable to perform its main function (supply torque) continuously within Zone A. However, this motor may not fully meet its performance characteristics due to power supply voltage and frequency variation, which can result in temperature rise above the rated value.

The motor must also be suitable to perform its main function (supply torque) at Zone B. However, the performance characteristic changes will be greater than those operating in Zone A. The temperature rise will also be higher than that at rated voltage and frequency and when operating within Zone A. Prolonged operation near the boundaries of Zone B is not recommended.

10 . Ambient & Insulation

Unless otherwise specified, the rated outputs shown in the electrical data tables within this catalogue refer to continuous duty operation S1, as per IEC 60034-1 and under the following conditions:

- Ambient temperature range -20 °C to +40 °C
- Altitudes up to 1000 metres above sea level

For operating temperatures and altitudes differing from those above, please contact WEG.

All W12 motors are supplied with the exclusive WISE®, insulation system, composed of enamelled wires, meeting the temperature class of 200 °C and impregnated with solvent free resin. The WISE® allows the motor to be driven by a frequency inverter.

11 . Motor Thermal Protection

Continuous duty motors must be protected from overload either by a device integrated into the motor or via an independent protection system, usually a thermal relay with rated or setting current, equal to or below the value obtained when multiplying the power supply rated current (In), as per Table 17.

Table 16 - Relay setting current referred to service factor

Service factor	Relay setting current
1,0 up to 1,15	In x S.F.
≥ 1,15	(In x S.F.) - 5%

Optionally, W12 motors can be supplied with thermostats and thermistors installed on their winding.

14 . Construction Features

Frame	IEC56	W63	W71	71	W80	90L	W100L
Mechanical features							
Nameplate markings	CE / UKCA						
Mounting	B14T			B34T	B3T		
Frame material	Aluminum						
Degree of protection (IP rating)	IP55						
Grounding	Simple grounding - one inside the terminal box						
Cooling method (IC)	TEFC (IC411)						
Fan and fan cover material	Industrial high-performance polymer						
Bearings	Shielded/clearance (DE)		ZZ				
	Shielded/clearance (NDE)		ZZ				
	Drive end	6201	6202	6203 6204	6204	6205 6206	6206
	Non-drive end	6201		6202		6205	
Lubrication	Type of grease	Mobil Polyrex EM					
	Grease fitting	Not applicable					
Drain	Closed plastic drain plug						
Terminal block	None				With		
Terminal box material	Industrial high-performance polymer				Aluminium		
Leads inlet	Main T-box	M20			M20 OR M25		
	Plug	Flat plastic plug for transport and storage				Knockout	
Shaft	Material		SAE 1040/45				
	DE threaded hole		M3	M4	M5	M6	M8
Key	Type A						
Vibration	Grade A						
Nameplate material	Label						
Painting	Type	Without					
	Color	No Finishing Paint					
Electrical features							
Design	N						
Voltage	230 V						
Winding	Impregnation	Immersion					
	Insulation class	F (DT=80K)					
Service factor	1.00						
Ambient temperature	-20 up to +40 °C						
Starting method	DOL						
Rotor	Aluminum die cast						
Thermal protector (Winding)	Not available						

11.1 Minimum distance from the wall

It is necessary to observe that, for the proper operation of the electric motors, it must be ensured that the air inlets are not obstructed and that the space around the motor is sufficient to maintain the air temperature at the entrance of the fan cover is less than the maximum ambient temperature indicated on the motor nameplate.

For motors installed in outdoor, there should be no obstructions at distances less than 22 mm from the fan cover in relation to the air intakes, in order to guarantee sufficient air flow to the ventilation system.

In indoors, the minimum distance of 22 mm from the fan cover in relation to the air inlets and the air temperature at the inlet of the ventilation system must be checked to avoid overheating the motor. For specific conditions, consult WEG.

12 . Tolerances for Electrical Data

The motors follow the performance tolerances established by the standards IEC 60034-1, adopted for single-phase motors.

13 . Packing

The standard packing for W12 motors are pallet. As optional, motors can be supplied with cardboard box. For motors with special dimensions, WEG must be requested to evaluate the packing dimensions.

15 . Optional Features

Feature	IEC56	W63	W71	71	W80	90L	W100L
Certification							
CE	S	S	S	S	S	S	S
Insulation Class							
F DT 105K	0	0	0	0	0	0	0
Thermal Trip Protection							
PTC Thermistor - 155°C - Tripping	0	0	0	0	0	0	0
Cable Gland							
Without	S	S	S	S	S	S	S
Plastic	0	0	0	0	0	0	0
Flange							
Flange FF (IEC) or D (NEMA) FF-115	NA	0	0	NA	NA	NA	NA
Flange FF (IEC) or D (NEMA) FF-130	NA	NA	NA	0	NA	NA	NA
Flange FF (IEC) or D (NEMA) FF-165	NA	NA	NA	NA	0	0	NA
Flange C-80	S	0	0	NA	NA	NA	NA
Flange C-90	0	S	0	NA	NA	NA	NA
Flange C-105	0	0	S	S	0	NA	NA
Flange C- DIN 120	NA	NA	NA	NA	0	NA	NA
Without polymeric flange	NA	0	0	NA	NA	NA	NA
Degree of protection							
IP54	0	0	0	0	0	0	0
IP55	S	S	S	S	S	S	S
Fan							
Plastic	S	S	S	s	s	s	s
Without fan	0	0	0	0	0	0	0
Threaded center hole (shaft)	0	0	0	0	0	0	0
Drive End Bearing Type - Without grease fitting							
ZZ	S	S	S	S	S	S	S
2RS	0	0	0	0	0	0	0
2RS-C3	0	0	0	0	0	0	0
ZZ-C3	0	0	0	0	0	0	0
Non Drive End Bearing Type - Without grease fitting							
2RS	0	0	0	0	0	0	0
2RS-C3	0	0	0	0	0	0	0
ZZ	S	S	S	S	S	S	S
ZZ-C3	0	0	0	0	0	0	0
Balance Type							
Without balance	S	S	S	S	S	S	S
Balance with 1/2 key	NA	NA	NA	S	S	NA	NA
Cooling Method							
TEFC (fan cooled)	S	S	S	S	S	S	S
TEAO (air over)	0	0	0	0	0	0	0
Bolt material							
Carbon steel bolts	S	S	S	S	S	S	S
Direction of Rotation							
Both	S	S	S	S	S	S	S
Counterclockwise	0	0	0	0	0	0	0
Clockwise	0	0	0	0	0	0	0
Packing							
Pallet	S	S	S	0	0	0	0
Cartoon	0	0	0	P	P	P	P

16 . Electrical Data

16.1 W12 Single-phase - Permanent Capacitor - 50 Hz

Output		Frame	Full Load Torque (Nm)	Locked Rotor Current I/In	Locked Rotor Torque Tl/Tn	Break-down Torque Tb/Tn	Inertia J (kgm ²)	Allowable locked rotor time (s)		Weight (kg)	Sound dB(A)	230 V									Full load current In (A)	Dimension L (mm)
								% of full load														
								Efficiency				Power Factor										
kW	HP	Hot	Cold	50	75	100	50	75	100	Rated speed (rpm)	30,0	41,0	51,0	0,92	0,96	0,98	0,783	207,5				
II Poles																						
0,09	0,12	IEC56	0,296	4,6	0,6	2,4	0,0002	6	13	4,0	55	2910	30,0	41,0	51,0	0,92	0,96	0,98	0,783	207,5		
0,09	0,12	W71	0,296	4,6	0,6	2,4	0,0002	6	13	4,0	55	2910	30,0	41,0	51,0	0,92	0,96	0,98	0,783	226,5		
0,09	0,12	W63	0,296	4,6	0,55	2,4	0,0002	6	13	4,0	55	2910	30,0	41,0	51,0	0,92	0,96	0,98	0,783	219,5		
0,12	0,16	IEC56	0,395	4,6	0,45	2,1	0,0002	6	13	4,3	55	2905	36,0	48,0	57,5	0,93	0,96	0,98	0,926	207,5		
0,12	0,16	W71	0,395	4,6	0,45	2,1	0,0002	6	13	4,3	55	2905	36,0	48,0	57,5	0,93	0,96	0,98	0,926	226,5		
0,12	0,16	W63	0,395	4,6	0,45	2,1	0,0002	6	13	4,3	55	2905	36,0	48,0	57,5	0,93	0,96	0,98	0,926	219,5		
0,18	0,25	IEC56	0,595	4,4	0,5	2	0,0002	6	13	4,6	55	2890	41,0	53,0	62,5	0,95	0,97	0,97	1,29	207,5		
0,18	0,25	W71	0,595	4,4	0,5	2	0,0002	6	13	4,6	55	2890	41,0	53,0	62,5	0,95	0,97	0,97	1,29	226,5		
0,18	0,25	W63	0,595	4,4	0,5	2	0,0002	6	13	4,6	55	2890	41,0	53,0	62,5	0,95	0,97	0,97	1,29	219,5		
0,25	0,33	IEC56	0,834	4,1	0,45	1,7	0,0003	6	13	4,9	55	2865	43,0	56,0	65,0	0,94	0,97	0,98	1,70	227,5		
0,25	0,33	W71	0,834	4,1	0,45	1,7	0,0003	6	13	4,9	55	2865	43,0	56,0	65,0	0,94	0,97	0,98	1,70	246,5		
0,25	0,33	W63	0,834	4,1	0,45	1,7	0,0003	6	13	4,9	55	2865	43,0	56,0	65,0	0,94	0,97	0,98	1,70	239,5		
0,37	0,5	IEC56	1,24	4,5	0,4	1,7	0,0003	6	13	5,7	55	2855	49,0	61,0	68,5	0,94	0,97	0,98	2,40	227,5		
0,37	0,5	W71	1,24	4,5	0,4	1,7	0,0003	6	13	5,7	55	2855	49,0	61,0	68,5	0,94	0,97	0,98	2,40	246,5		
0,37	0,5	W63	1,24	4,5	0,4	1,7	0,0003	6	13	5,7	55	2855	49,0	61,0	68,5	0,94	0,97	0,98	2,40	239,5		
0,55	0,75	IEC56	1,87	4,7	0,45	1,65	0,0000	6	13	6,7	55	2810	59,0	68,0	72,5	0,94	0,97	0,98	3,37	227,5		
0,55	0,75	W71	1,87	4,7	0,45	1,65	0,0000	6	13	6,7	55	2810	59,0	68,0	72,5	0,94	0,97	0,98	3,37	246,5		
0,55	0,75	W63	1,87	4,7	0,45	1,65	0,0000	6	13	6,7	55	2810	59,0	68,0	72,5	0,94	0,97	0,98	3,37	239,5		
0,55	0,75	71	1,87	4,1	0,52	1,85	0,0007	6	13	9,2	56	2805	56,5	66,0	70,4	0,94	0,97	0,99	3,43	304,5		
0,55	0,75	W80	1,87	4,1	0,52	1,85	0,0007	6	13	9,2	56	2805	56,5	66,0	70,4	0,94	0,97	0,99	3,43	314,5		
0,75	1	71	2,54	4,3	0,5	1,85	0,0009	6	13	10,2	56	2820	59,5	69,0	72,5	0,96	0,97	0,99	4,54	304,5		
0,75	1	W80	2,54	4,3	0,5	1,85	0,0009	6	13	10,2	56	2820	59,5	69,0	72,5	0,96	0,97	0,99	4,54	314,5		
1,1	1,5	71	3,74	4,4	0,42	1,8	0,0011	6	13	11,6	56	2810	65,0	72,7	75,0	0,92	0,96	0,97	6,57	304,5		
1,1	1,5	W80	3,74	4,4	0,42	1,8	0,0011	6	13	11,6	56	2810	65,0	72,7	75,0	0,92	0,96	0,97	6,57	314,5		
1,5	2	71	5,10	4,6	0,4	1,8	0,0014	6	13	13,3	56	2810	68,7	75,5	76,5	0,93	0,96	0,97	8,79	304,5		
1,5	2	W80	5,10	4,6	0,4	1,8	0,0014	6	13	13,3	56	2810	68,7	75,5	76,5	0,93	0,96	0,97	8,79	314,5		
1,5	2	90L	5,03	5,4	0,4	2	0,0051	6	13	16,5	62	2850	66,0	73,5	76,0	0,96	0,97	0,98	8,76	393,5		
1,5	2	W100L	5,03	5,4	0,4	2	0,0051	6	13	16,5	62	2850	66,0	73,5	76,0	0,96	0,97	0,98	8,76	403,5		
2,2	3	90L	7,41	5,1	0,4	1,9	0,0062	6	13	19,0	62	2835	69,0	76,0	78,0	0,95	0,96	0,97	12,6	393,5		
2,2	3	W100L	7,41	5,1	0,4	1,9	0,0062	6	13	19,0	62	2835	69,0	76,0	78,0	0,95	0,96	0,97	12,6	403,5		
3	4	90L	10,1	5,6	0,4	1,9	0,0079	6	13	23,0	62	2840	72,0	78,5	80,0	0,95	0,96	0,97	16,8	393,5		
3	4	W100L	10,1	5,6	0,4	1,9	0,0079	6	13	23,0	62	2840	72,0	78,5	80,0	0,95	0,96	0,97	16,8	403,5		
4	5,5	90L	13,5	6,5	0,4	2	0,0090	6	13	27,0	62	2840	76,0	81,0	82,0	0,96	0,97	0,98	21,6	393,5		
4	5,5	W100L	13,5	6,5	0,4	2	0,0090	6	13	27,0	62	2840	76,0	81,0	82,0	0,96	0,97	0,98	21,6	403,5		
IV Poles																						
0,09	0,12	IEC56	0,608	2,9	0,6	1,6	0,0004	22	48	4,0	47	1415	29,0	40,0	50,5	0,95	0,97	0,98	0,791	207,5		
0,09	0,12	W71	0,608	2,9	0,6	1,6	0,0004	22	48	4,0	47	1415	29,0	40,0	50,5	0,95	0,97	0,98	0,791	226,5		
0,09	0,12	W63	0,608	2,9	0,6	1,6	0,0004	22	48	4,0	47	1415	29,0	40,0	50,5	0,95	0,97	0,98	0,791	219,5		
0,12	0,16	IEC56	0,816	3,3	0,5	1,5	0,0005	23	51	4,4	47	1405	37,0	50,0	58,5	0,92	0,96	0,98	0,910	207,5		
0,12	0,16	W71	0,816	3,3	0,5	1,5	0,0005	23	51	4,4	47	1405	37,0	50,0	58,5	0,92	0,96	0,98	0,910	226,5		
0,12	0,16	W63	0,816	3,3	0,5	1,5	0,0005	23	51	4,4	47	1405	37,0	50,0	58,5	0,92	0,96	0,98	0,910	219,5		
0,18	0,25	IEC56	1,22	3,6	0,4	1,5	0,0006	15	33	5,5	47	1415	40,0	52,0	60,5	0,77	0,87	0,92	1,41	207,5		
0,18	0,25	W71	1,22	3,6	0,4	1,5	0,0006	15	33	5,5	47	1415	40,0	52,0	60,5	0,77	0,87	0,92	1,41	226,5		
0,18	0,25	W63	1,22	3,6	0,4	1,5	0,0006	15	33	5,5	47	1415	40,0	52,0	60,5	0,77	0,87	0,92	1,41	219,5		
0,25	0,33	IEC56	1,71	4,0	0,55	1,7	0,0007	23	51	6,3	47	1400	48,0	60,0	67,5	0,88	0,94	0,97	1,66	227,5		
0,25	0,33	W71	1,71	4,0	0,55	1,7	0,0007	23	51	6,3	47	1400	48,0	60,0	67,5	0,88	0,94	0,97	1,66	246,5		
0,25	0,33	W63	1,71	4,0	0,55	1,7	0,0007	23	51	6,3	47	1400	48,0	60,0	67,5	0,88	0,94	0,97	1,66	239,5		
0,37	0,5	71	2,50	3,6	0,46	1,65	0,0026	5	11	15,4	47	1415	50,5	61,5	66,5	0,97	0,98	0,99	2,44	304,5		
0,37	0,5	W80	2,50	3,6	0,46	1,65	0,0026	5	11	15,4	47	1415	50,5	61,5	66,5	0,97	0,98	0,99	2,44	314,5		
0,55	0,75	71	3,71	3,9	0,4	1,65	0,0033	5	11	16,8	47	1415	55,5	65,5	69,5	0,93	0,97	0,99	3,47	304,5		
0,55	0,75	W80	3,71	3,9	0,4	1,65	0,0033	5	11	16,8	47	1415	55,5	65,5	69,5	0,93	0,97	0,99	3,47	314,5		
0,75	1	71	5,06	4,0	0,39	1,6	0,0042	5	11	18,5	47	1415	59,5	68,5	71,5	0,96	0,97	0,99	4,61	304,5		
0,75	1	W80	5,06	4,0	0,39	1,6	0,0042	5	11	18,5	47	1415	59,5	68,5	71,5	0,96	0,97	0,99	4,61	314,5		
0,75	1	90L	4,98	5,1	0,39	1,9	0,0054	18	40	14,0	49	1440	62,0	71,0	74,5	0,93	0,96	0,97	4,51	393,5		
0,75	1	W100L	4,98	5,1	0,39	1,9	0,0054	18	40	14,0	49	1440	62,0	71,0	74,5	0,93	0,96	0,97	4,51	403,5		
1,1	1,5	90L	7,27	5,5	0,35	1,9	0,0073	15	33	16,5	49	1445	65,0	74,0	77,0	0,96	0,97	0,98	6,34	393,5		
1,1	1,5	W100L	7,27	5,5	0,35	1,9	0,0073	15	33	16,5	49	1445	65,0	74,0	77,0	0,96	0,97	0,98	6,34	403,5		
1,5	2	90L	9,88	5,7	0,35	1,9	0,0096	12	26	20,0	49	1450	66,0	74,5	78,0	0,96	0,97	0,98	8,53	393,5		
1,5	2	W100L	9,88	5,7	0,35	1,9	0,0096	12	26	20,0	49	1450	66,0	74,5	78,0	0,96	0,97	0,98	8,53	403,5		
2,2	3	90L	14,6	5,3	0,34	1,9	0,0107	15	33	23,0	49	1435	70,0	77,5	80,0	0,93	0,95	0,97	12,3	393,5		
2,2	3	W100L	14,6	5,3	0,34	1,9	0,0107	15	33	23,0	49	1435	70,0	77,5	80,0	0,93	0,95	0,97	12,3	403,5		
3	4	90L*	20,1	5,2	0,31	1,7	0,0123	12	26	26,0	49	1425	75,0	81,0	81,5	0,96	0,97	0,98	16,3	393,5		
3	4	W100L*	20,1	5,2	0,31	1,7	0,0123	12	26	26,0	49	1425	75,0	81,0	81,5	0,96	0,97	0,98	16,3	403,5		

16.2 W12 IE2 Single-phase - Permanent Capacitor - 50 Hz

Output		Frame	Full Load Torque (Nm)	Locked Rotor Current I/In	Locked Rotor Torque Tl/Tn	Break-down Torque Tb/Tn	Inertia J (kgm ²)	Allowable locked rotor time (s)		Weight (kg)	Sound dB(A)	230 V									Dimension L (mm)
								Rated speed (rpm)	% of full load						Full load current In (A)						
									Efficiency			Power Factor									
kW	HP							Hot	Cold			50	75	100	50	75	100				
II Poles																					
0,09	0,12	IEC56	0,297	4,2	0,55	2,35	0,0002	6	13	3,0	55	2895	32,0	42,5	51,0	0,96	0,97	0,99	0,775	207,5	
0,09	0,12	W63	0,297	4,2	0,55	2,35	0,0002	6	13	3,0	55	2895	32,0	42,5	51,0	0,96	0,97	0,99	0,775	219,5	
0,09	0,12	W71	0,297	4,2	0,55	2,35	0,0002	6	13	3,0	55	2895	32,0	42,5	51,0	0,96	0,97	0,99	0,775	226,5	
0,12	0,16	IEC56	0,397	3,9	0,5	2,2	0,0002	6	13	3,2	55	2885	34,5	45,5	53,6	0,96	0,97	0,98	0,993	207,5	
0,12	0,16	W63	0,397	3,9	0,5	2,2	0,0002	6	13	3,2	55	2885	34,5	45,5	53,6	0,96	0,97	0,98	0,993	219,5	
0,12	0,16	W71	0,397	3,9	0,5	2,2	0,0002	6	13	3,2	55	2885	34,5	45,5	53,6	0,96	0,97	0,98	0,993	226,5	
0,18	0,25	IEC56	0,596	3,7	0,5	2,15	0,0003	6	13	3,8	55	2885	39,5	51,5	60,4	0,89	0,90	0,92	1,41	207,5	
0,18	0,25	W63	0,596	3,7	0,5	2,15	0,0003	6	13	3,8	55	2885	39,5	51,5	60,4	0,89	0,90	0,92	1,41	219,5	
0,18	0,25	W71	0,596	3,7	0,5	2,15	0,0003	6	13	3,8	55	2885	39,5	51,5	60,4	0,89	0,90	0,92	1,41	226,5	
0,25	0,33	IEC56	0,835	3,9	0,5	1,8	0,0003	6	13	4,0	55	2860	45,5	56,5	64,8	0,93	0,94	0,95	1,77	227,5	
0,25	0,33	W63	0,835	3,9	0,5	1,8	0,0003	6	13	4,0	55	2860	45,5	56,5	64,8	0,93	0,94	0,95	1,77	239,5	
0,25	0,33	W71	0,835	3,9	0,5	1,8	0,0003	6	13	4,0	55	2860	45,5	56,5	64,8	0,93	0,94	0,95	1,77	246,5	
0,37	0,5	IEC56	1,24	4,1	0,5	1,75	0,0004	6	13	4,8	55	2845	52,0	63,0	69,5	0,96	0,97	0,98	2,36	227,5	
0,37	0,5	W63	1,24	4,1	0,5	1,75	0,0004	6	13	4,8	55	2845	52,0	63,0	69,5	0,96	0,97	0,98	2,36	239,5	
0,37	0,5	W71	1,24	4,1	0,5	1,75	0,0004	6	13	4,8	55	2845	52,0	63,0	69,5	0,96	0,97	0,98	2,36	246,5	
0,55	0,75	IEC56	1,87	4,6	0,5	1,8	0,0004	6	13	5,2	55	2815	60,0	69,5	74,1	0,95	0,97	0,99	3,26	227,5	
0,55	0,75	W63	1,87	4,6	0,5	1,8	0,0004	6	13	5,2	55	2815	60,0	69,5	74,1	0,95	0,97	0,99	3,26	239,5	
0,55	0,75	W71	1,87	4,6	0,5	1,8	0,0004	6	13	5,2	55	2815	60,0	69,5	74,1	0,95	0,97	0,99	3,26	246,5	
0,55	0,75	71	1,84	4,9	0,56	2,2	0,0008	6	13	9,8	56	2855	58,5	68,0	74,1	0,97	0,98	0,99	3,26	304,5	
0,55	0,75	W80	1,84	4,9	0,56	2,2	0,0008	6	13	9,8	56	2855	58,5	68,0	74,1	0,97	0,98	0,99	3,26	314,5	
0,75	1	71	2,51	5,0	0,52	2,2	0,0010	6	13	11,2	56	2860	63,5	72,0	77,4	0,97	0,98	0,99	4,24	304,5	
0,75	1	W80	2,51	5,0	0,52	2,2	0,0010	6	13	11,2	56	2860	63,5	72,0	77,4	0,97	0,98	0,99	4,24	314,5	
1,1	1,5	71	3,67	5,3	0,45	2,1	0,0014	6	13	13,3	56	2860	68,5	76,0	79,6	0,97	0,98	0,99	6,07	304,5	
1,1	1,5	W80	3,67	5,3	0,45	2,1	0,0014	6	13	13,3	56	2860	68,5	76,0	79,6	0,97	0,98	0,99	6,07	314,5	
1,5	2	71	5,08	4,9	0,45	1,95	0,0014	6	13	14,4	56	2820	72,5	79,0	81,3	0,97	0,98	0,99	8,10	304,5	
1,5	2	W80	5,08	4,9	0,45	1,95	0,0014	6	13	14,4	56	2820	72,5	79,0	81,3	0,97	0,98	0,99	8,10	314,5	
1,5	2	90L	4,97	6,1	0,45	2,5	0,0070	6	13	21,0	62	2885	70,0	77,0	81,3	0,84	0,91	0,94	8,53	393,5	
1,5	2	W100L	4,97	6,1	0,45	2,5	0,0070	6	13	21,0	62	2885	70,0	77,0	81,3	0,84	0,91	0,94	8,53	403,5	
2,2	3	90L	7,29	6,3	0,45	2,5	0,0090	6	13	25,0	62	2885	73,0	80,0	83,2	0,79	0,88	0,92	12,5	393,5	
2,2	3	W100L	7,29	6,3	0,45	2,5	0,0090	6	13	25,0	62	2885	73,0	80,0	83,2	0,79	0,88	0,92	12,5	403,5	
3	4	90L	10,0	6,2	0,43	2,3	0,0090	6	13	27,5	62	2855	77,5	83,0	84,6	0,87	0,92	0,95	16,2	393,5	
3	4	W100L	10,0	6,2	0,43	2,3	0,0090	6	13	27,5	62	2855	77,5	83,0	84,6	0,87	0,92	0,95	16,2	403,5	
IV Poles																					
0,09	0,12	IEC56	0,606	2,6	0,6	1,6	0,0004	6	13	3,4	47	1420	33,0	44,5	52,5	0,93	0,94	0,95	0,785	207,5	
0,09	0,12	W63	0,606	2,6	0,6	1,6	0,0004	6	13	3,4	47	1420	33,0	44,5	52,5	0,93	0,94	0,95	0,785	219,5	
0,09	0,12	W71	0,606	2,6	0,6	1,6	0,0004	6	13	3,4	47	1420	33,0	44,5	52,5	0,93	0,94	0,95	0,785	226,5	
0,12	0,16	IEC56	0,805	3,2	0,55	1,75	0,0006	6	13	4,2	47	1425	40,0	51,0	59,1	0,95	0,96	0,97	0,910	207,5	
0,12	0,16	W63	0,805	3,2	0,55	1,75	0,0006	6	13	4,2	47	1425	40,0	51,0	59,1	0,95	0,96	0,97	0,910	219,5	
0,12	0,16	W71	0,805	3,2	0,55	1,75	0,0006	6	13	4,2	47	1425	40,0	51,0	59,1	0,95	0,96	0,97	0,910	226,5	
0,18	0,25	IEC56	1,23	2,6	0,5	1,5	0,0007	6	13	4,8	47	1395	45,0	57,5	64,7	0,91	0,94	0,95	1,27	207,5	
0,18	0,25	W63	1,23	2,6	0,5	1,5	0,0007	6	13	4,8	47	1395	45,0	57,5	64,7	0,91	0,94	0,95	1,27	219,5	
0,18	0,25	W71	1,23	2,6	0,5	1,5	0,0007	6	13	4,8	47	1395	45,0	57,5	64,7	0,91	0,94	0,95	1,27	226,5	
0,25	0,33	IEC56	1,72	3,2	0,55	1,55	0,0007	6	13	5,0	47	1385	52,0	63,0	68,5	0,95	0,96	0,97	1,64	227,5	
0,25	0,33	W63	1,72	3,2	0,55	1,55	0,0007	6	13	5,0	47	1385	52,0	63,0	68,5	0,95	0,96	0,97	1,64	239,5	
0,25	0,33	W71	1,72	3,2	0,55	1,55	0,0007	6	13	5,0	47	1385	52,0	63,0	68,5	0,95	0,96	0,97	1,64	246,5	
0,37	0,5	71	2,48	4,1	0,43	1,75	0,0029	6	13	16,1	47	1425	57,5	67,0	72,7	0,97	0,98	0,99	2,24	304,5	
0,37	0,5	W80	2,48	4,1	0,43	1,75	0,0029	6	13	16,1	47	1425	57,5	67,0	72,7	0,97	0,98	0,99	2,24	314,5	
0,55	0,75	71	3,69	4,0	0,42	1,7	0,0038	6	13	18,1	47	1425	64,5	73,0	77,1	0,97	0,98	0,99	3,13	304,5	
0,55	0,75	W80	3,69	4,0	0,42	1,7	0,0038	6	13	18,1	47	1425	64,5	73,0	77,1	0,97	0,98	0,99	3,13	314,5	
0,75	1	71	5,08	4,4	0,42	1,7	0,0042	6	13	19,3	47	1410	70,0	77,0	79,6	0,97	0,98	0,99	4,14	304,5	
0,75	1	W80	5,08	4,4	0,42	1,7	0,0042	6	13	19,3	47	1410	70,0	77,0	79,6	0,97	0,98	0,99	4,14	284,5	
0,75	1	90L	4,91	6,3	0,42	2,4	0,0084	6	13	18,5	49	1460	65,0	74,5	79,6	0,89	0,95	0,96	4,27	393,5	
0,75	1	W100L	4,91	6,3	0,42	2,4	0,0084	6	13	18,5	49	1460	65,0	74,5	79,6	0,89	0,95	0,96	4,27	403,5	
1,1	1,5	90L	7,20	6,5	0,4	2,4	0,0096	6	13	20,5	49	1460	68,5	77,0	81,4	0,91	0,95	0,97	6,06	393,5	
1,1	1,5	W100L	7,20	6,5	0,4	2,4	0,0096	6	13	20,5	49	1460	68,5	77,0	81,4	0,91	0,95	0,97	6,06	403,5	
1,5	2	90L	9,82	6,4	0,38	2,4	0,0123	6	13	25,0	49	1460	70,5	78,5	82,8	0,83	0,91	0,94	8,38	393,5	
1,5	2	W100L	9,82	6,4	0,38	2,4	0,0123	6	13	25,0	49	1460	70,5	78,5	82,8	0,83	0,91	0,94	8,38	403,5	
2,2	3	90L	14,5	5,8	0,35	2,1	0,0123	6	13	26,0	49	1445	75,0	81,5	84,3	0,87	0,93	0,96	11,8	393,5	
2,2	3	W100L	14,5	5,8	0,35	2,1	0,0123	6	13	26,0	49	1445	75,0	81,5	84,3	0,87	0,93	0,96	11,8	403,5	

17 . Mechanical Data

17.1 Single-phase foot mounted motors

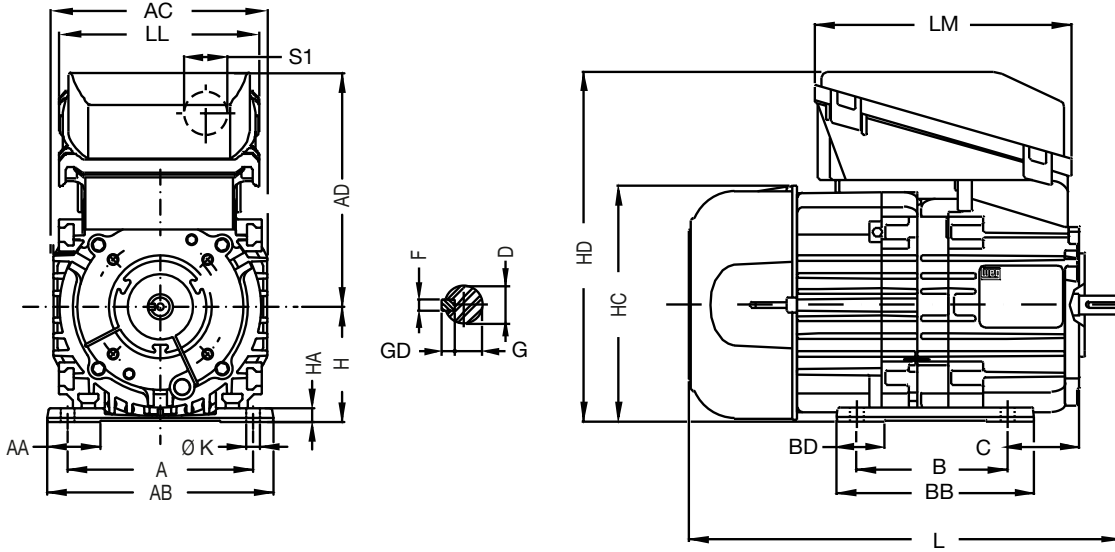

Frame	A	AA	AB	AC	AD	K	H	HA
IEC56	90	26	110	105	110,6	6,6	56	6,5
W63	100	32	120			7	63	6,7
W71	112	38	132			7	71	7,5
71		36	147	7	7			
W80	125	41	155	140	153,8	10	80	8
90L	140	40	171	180	183,8	10	90	11,5
W100L	160	45	187			12	100	

Frame	L	B	BB	BD	C	HC	HD	LL	LM	S1
IEC56	See the electric table	71	95	14,3	36	114	167	123	96	22,4
W63		80	104	11	40	124	176			
W71		90	117	16	45	129	184			
71			115	10		141	215			
W80		100	125	10	50	150	224	194	154	
90L		125	155	16,25	56	185	250	250	199	28,4 / 22,4
W100L		140	175	18	63	190	260			

1) All dimensions are in mm.

3) Dimensions AD for footless motors.

Note: IEC56, 71 and W80 frames, the frame has a spigot on DE Endshield.

17.2 C-DIN Flange

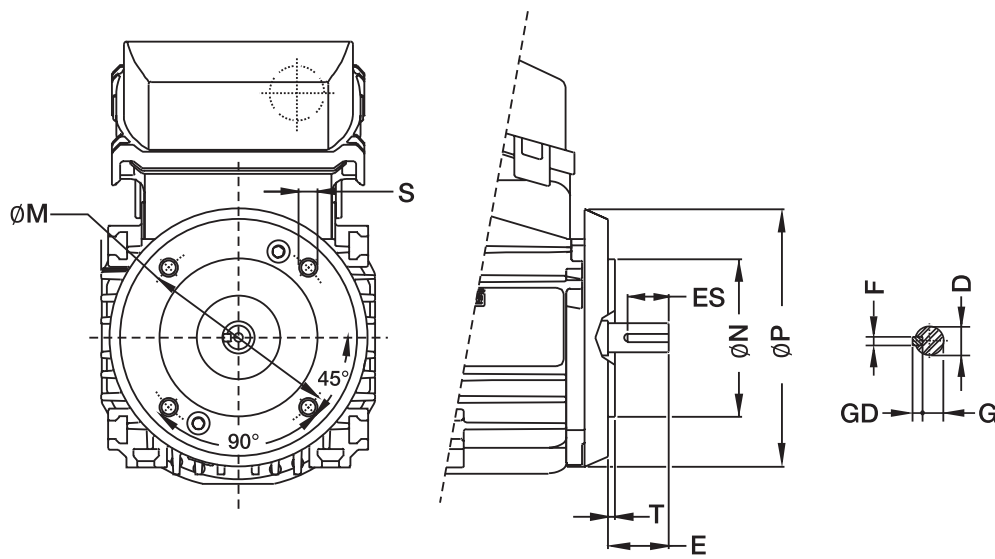

Frame	Flange	Flange					Shaft					
		M	S	N	P	T	D	E	ES	F	G	GD
IEC56	C-80	65	M5 ²⁾	50 ³⁾	95	2,5	9	20	12	3	7,2	3
W63	C-90	75	M5	60 ³⁾	98		11	23	14	4	8,5	4
W71 71	C-105	85	M6 ²⁾	70 ³⁾	108 111		14	30	18	5	11	5
W80	C-120	100		80 ³⁾	111	3	19	40	28	6	15,5	6
90L	C-140	115	M8	95 ³⁾	170,5		24	50	36	8	20	7
W100L	C-160	130		110 ³⁾	170,5	3,5	28	60	45		24	

- 1) All dimensions are in mm.
- 2) Holes fit for screw
- 3) Tolerance -0,075mm for aluminum flanges and -0,5mm for polymeric.

17.3 FF Flange

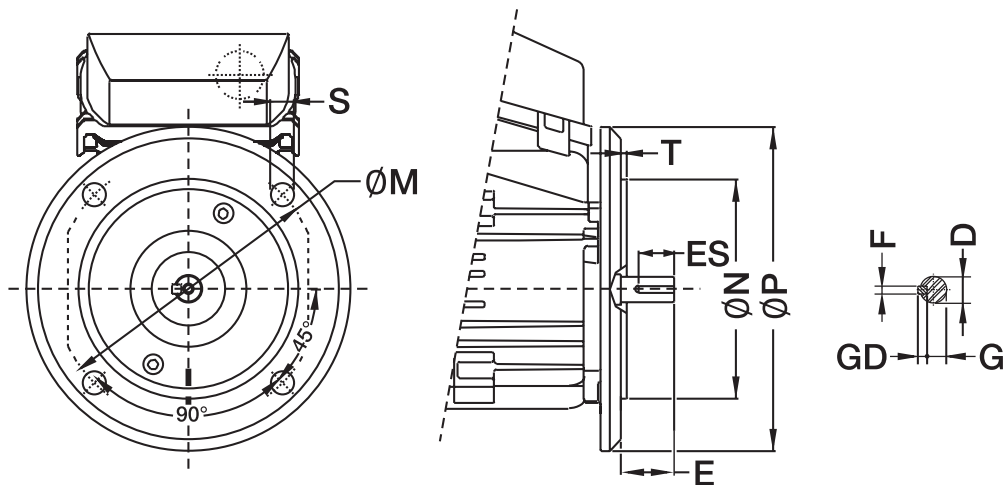

Frame	Flange	Flange					Shaft					
		S	M	N	P	T	D	E	ES	F	G	GD
W63	FF-115	10	115	95 ³⁾	140	3	11	23	14	4	8,5	4
71	FF-130		130	110 ³⁾	160	3,5	14	30	18	5	11	5
W80	FF-165	12	165	130 ³⁾	200		3,5	19	40	28	6	15,5
90L						24		50	36	8		
W100L	FF-215	15	215	180 ³⁾	250	4	28	60	45	8	24	7

- 1) All dimensions are in mm.
- 3) Tolerance -0,075mm for aluminum flanges and -0,5mm for polymeric.

The scope of WEG Group solutions is not limited to products and solutions presented in this catalogue.

To see our portfolio, contact us.

For WEG's worldwide operations visit our website



www.weg.net



 +55 47 3276.4000

 motores@weg.net

 Jaraguá do Sul - SC - Brasil

Cód: 50107015 | Rev: 03 | Date (m/a): 03/2023.

The values shown are subject to change without prior notice.
The information contained is reference values.