

**ATENÇÃO:**  
 -Desconecte da rede elétrica antes de proceder qualquer trabalho neste equipamento.  
 -Somente profissionais qualificados podem efetuar a instalação e manutenção.  
 -Obedecer normas nacionais, estaduais, locais e instruções de operação.

**WARNING:**  
 -Installation and maintenance to be performed by authorized personnel only.  
 -User is cautioned to observe all recommendations, warnings and cautions relating to safety of personnel and equipment as well as general and local health and safety laws, codes and procedures.

**ATENCIÓN:**  
 - Desconectar de la red eléctrica antes de hacer cualquier trabajo en este equipamiento.  
 -Recomiendase instalación por profesional calificado.  
 -Respetar normas nacionales y locales.  
 - Producto destinado a utilización en instalaciones eléctricas de baja tensión.

**WARNING:**  
 - Bevor irgend eine Arbeit am Gerät vorgenommen wird, muss sichergestellt sein, dass die Einheit stromlos und freigeschaltet ist.  
 - Sämtliche Arbeiten an der Einheit dürfen daher ausschließlich nur von Fachpersonal vorgenommen werden.  
 - Die jeweils geltenden nationalen, örtlichen und anlagenspezifischen Bestimmungen und Erfordernisse sind zu berücksichtigen.

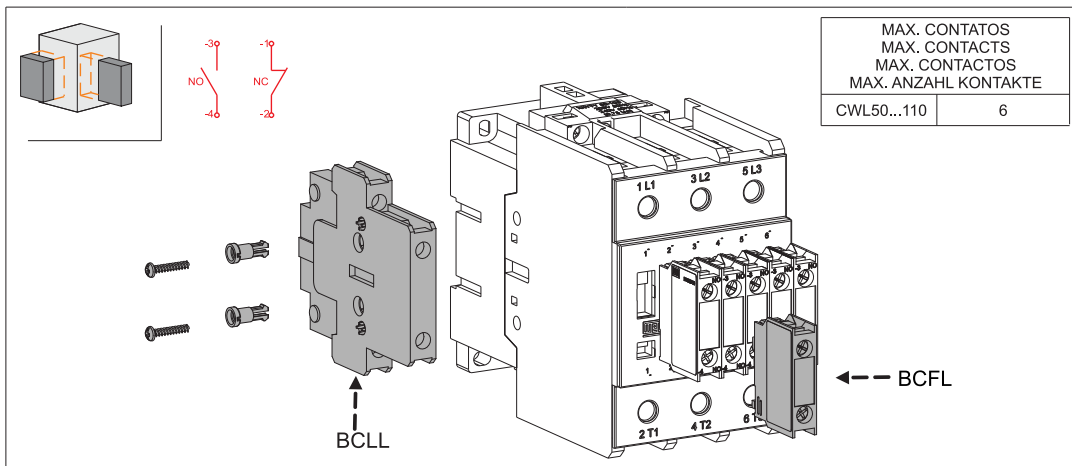
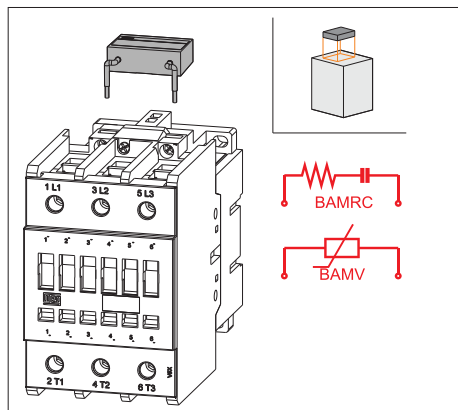
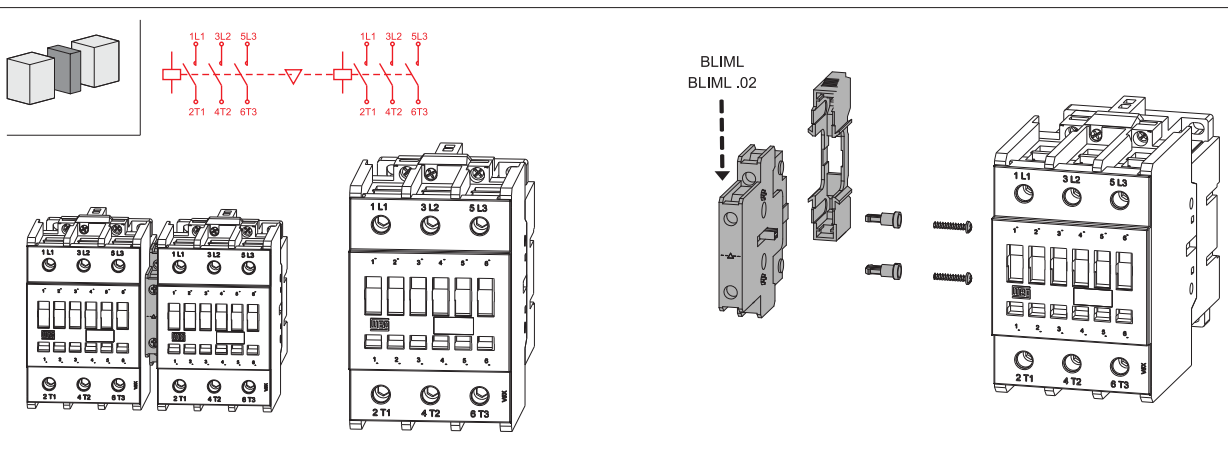

|  |   |
|--|---|
| MAX. CONTATOS<br>MAX. CONTACTS<br>MAX. CONTACTOS<br>MAX. ANZAHL KONTAKTE | 6 |
| CWL50...110  |   |

**WEG IMPORTERS IN THE EUROPEAN UNION**  
 AUSTRIA - WATT DRIVE ANTRIEBSTECHNIK GMBH - Wöllersdorfer Str. 68, 2753 Markt Piesting, Wiener, Austria; **BELGIUM** - WEG BENELUX S.A. - Rue de l'Industrie 30/D, 1400 Nivelles, Belgium; **FRANCE** - WEG FRANCE SAS - 13 Rue du Moreillon, 38297 Saint Quentin Fallavier, France; **GERMANY** - WEG GERMAN GMBH - Geisigerstraße 7, 50169 Industriepark Tümmel 3, Kerpen, Germany; **ITALY** - WEG ITALIA S.R.L. - Via Viganò di Vizzi, 93/95, 20092 Cinisello Balsamo, Milano, Italy; **NETHERLANDS** - WEG NETHERLANDS - Hanzspoor 23C, 7975 DB Oldenzaal, Netherlands; **PORTUGAL** - WEG EURO-INDUSTRIA ELECTRICA S.A. - R. Eng. Frederico Ulrich 605, 4471-908 Maia, Portugal; **SPAIN** - WEG IBERIA INDUSTRIAL S.L. - O Tierra de Barros, 5-7, 28823 Coslada, Madrid, Spain; **SCANDINAVIA** - WEG SCANDINAVIA AB - Box 27, 435 21, 43533 Mölndal, Sweden; **UNITED KINGDOM** - WEG (UK) LTD - Broad Ground Road, Redditch B988YP, Worcestershire, United Kingdom.  
 Information valid for WEG Group Importers.

**GARANTIA / WARRANTY / GARANTÍA / GEWÄHRLEISTUNG:**  
 A WEG oferece garantia limitada contra defeitos de fabricação ou de materiais de seus produtos. Para mais informações acesse nosso site: [www.weg.net](http://www.weg.net)  
 WEG provides a limited warranty for its products against defects in materials and workmanship. For more information access our site: [www.weg.net](http://www.weg.net)  
 WEG ofrece garantía limitada contra defectos de fabricación o de materiales de sus productos. Para más informaciones acceda al WEG sitio: [www.weg.net](http://www.weg.net)  
 WEG bietet eine beschränkte Gewährleistung für ihre Produkte gegen Herstellungs- und Materialfehler. Für weitere Informationen besuchen Sie bitte unsere Webseite: [www.weg.net](http://www.weg.net)  
[www.weg.net/warranty-automation](http://www.weg.net/warranty-automation)

10006204065.01  
**WEG Automação**  
[www.weg.net](http://www.weg.net)

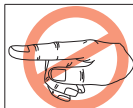
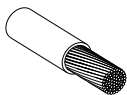

-PROIBIDO ACCIONAMIENTO MANUAL.  
 -MANUAL ACTIVATION IS PROHIBITED.  
 -ACTIVACION MANUAL ESTÁ PROHIBIDA.  
 -MANUAL ACTIVATION IS FORBIDDEN.

|  |                 | CWL50...95 |          |          | CWL110   |          |          |
|--|-----------------|------------|----------|----------|----------|----------|----------|
|  |                 |            |          |          |          |          |          |
|  | mm <sup>2</sup> | 2,5...25   | 6...35   | 2,5...35 | 4...35   | 6...35   | 4...35   |
|  | mm <sup>2</sup> | 1...25     | 1,5...35 | 1...35   | 1,5...50 | 2,5...50 | 1,5...50 |
|  | mm <sup>2</sup> | 2,5...35   | 6...35   | 2,5...35 | 4...35   | 6...35   | 4...35   |
|  | mm <sup>2</sup> | 1...35     | 1,5...35 | 1...35   | 1,5...50 | 2,5...50 | 1,5...50 |
|  | <i>N.m</i>      | 4...6      |          |          | 5...6,5  |          |          |

|  |                 | CWL50...110                              |                        |  |
|--|-----------------|--|------------------------|--|
|  |                 |  |                        |  |
|  | mm <sup>2</sup> | 1X 0,5...4<br>2X 0,5...1,5<br>2X 1...2,5 | 1X 1...4<br>2X 1...2,5 | 1X 0,5...4<br>2X 0,5...1,5<br>2X 1...2,5 |
|  | <i>N.m</i>      | 0,8...1,1                                |                        |  |

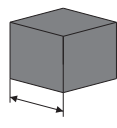

mm  
in

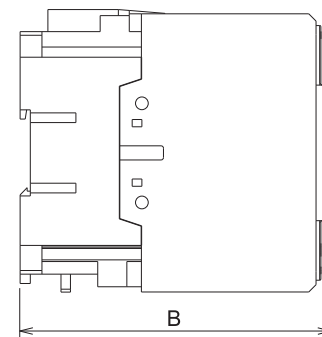
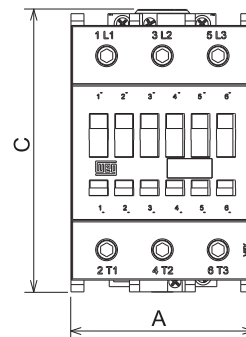

| CWL     | A             | B              | C              |
|---------|---------------|----------------|----------------|
| 50...95 | 66,04<br>2.04 | 115,06<br>4.53 | 116,33<br>4.58 |
| 110     | 75,44<br>2.97 | 126,24<br>4.97 | 116,33<br>4.58 |

