

DeviceNet

SSW900-CAN-W V1.6X

User's Guide

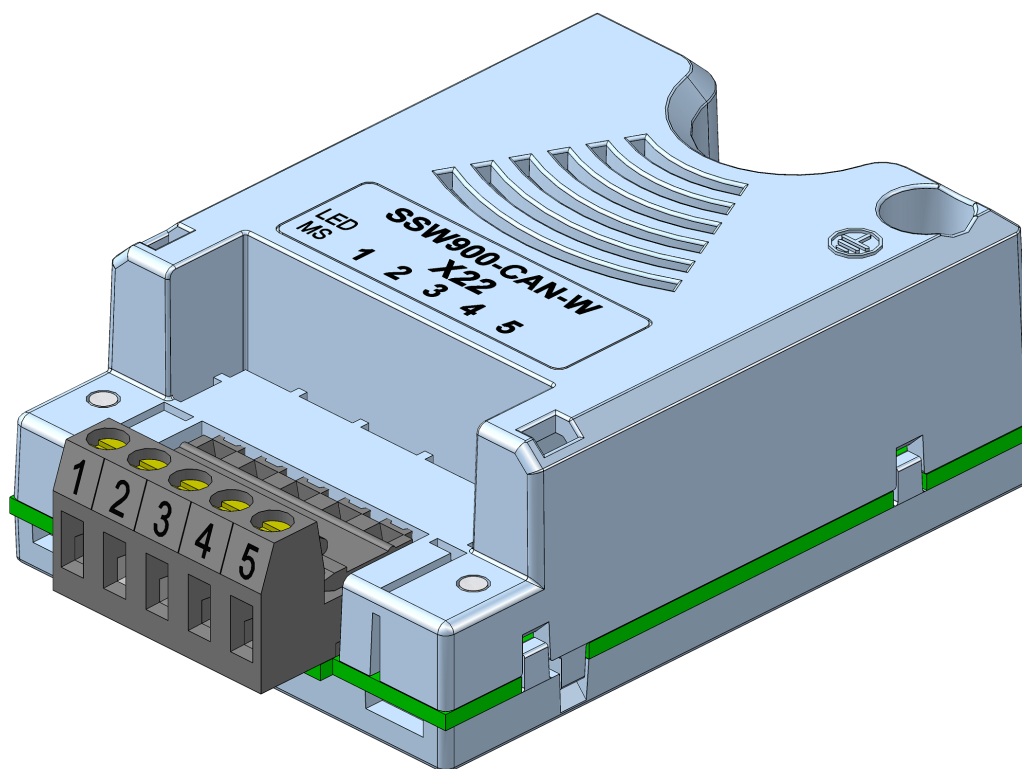



User's Guide

SSW900-CAN-W

Software version: 1.6X

Document: 10006223733

Revision: 04

Publication Date: 10/2024

SUMMARY OF REVISIONS

The information below describes the reviews made in this manual.

Version	Revision	Description	Date
V1.2X	R00	First edition.	01/2019
V1.3X	R01	Parameters related to the SSW900-CETH-W accessory. Parameter for adjusting the contrast of the HMI display. Text corrections.	02/2021
V1.4X	R02	C6.2.1, C11.4. Text corrections.	11/2021
V1.5X	R03	General Revision.	09/2022
V1.6X	R04	C8.3.11, C8.5.11	10/2024

CONTENTS

ABOUT THE MANUAL	0-1
ABBREVIATIONS AND DEFINITIONS	0-1
NUMERICAL REPRESENTATION	0-1
DOCUMENTS	0-1
IMPORTANT NOTICE	0-2
TRADEMARKS	0-2
1 MAIN CHARACTERISTICS	1-1
2 INTERFACE DESCRIPTION	2-1
2.1 DEVICENET ACCESSORY	2-1
2.2 CONNECTOR	2-1
2.3 POWER SUPPLY	2-2
2.4 INDICATION LEDS	2-2
3 DEVICENET NETWORK INSTALLATION	3-1
3.1 BAUD RATE	3-1
3.2 ADDRESS IN THE DEVICENET NETWORK	3-1
3.3 TERMINATION RESISTOR	3-1
3.4 CABLE	3-1
3.5 CONNECTION IN THE NETWORK	3-1
4 S STATUS	4-1
S5 COMMUNICATIONS	4-1
S5.1 Status Word	4-1
S5.2 Command Word	4-1
S5.3 Value for Outputs	4-2
S5.3.2 Value for AO	4-2
S5.7 CANopen/DeviceNet	4-3
5 C CONFIGURATIONS	5-1
C8 COMMUNICATIONS	5-1
C8.1 I/O Data	5-1
C8.1.1 Data Read	5-1
C8.1.2 Data Write	5-2
C8.4 CANopen/DeviceNet	5-4
C8.4.5 CAN Error	5-5
6 OPERATION IN THE DEVICENET NETWORK	6-1
6.1 CYCLIC DATA	6-1
6.1.1 Input words	6-1
6.1.2 Output Words	6-2
6.2 ACYCLIC DATA	6-3
6.3 EDS FILE	6-3
6.4 SUPPORTED OBJECT CLASSES	6-3
6.4.1 Identity Class (01h)	6-3
6.4.2 Message Router Class (02h)	6-3
6.4.3 DeviceNet Class (03h)	6-4
6.4.4 Assembly Class (04h)	6-4
6.4.5 Connection Class (05h)	6-4
6.4.5.1 Instance 1: Explicit Message	6-5
6.4.5.2 Instance 2: Polled	6-5
6.4.5.3 Instance 4: Change of State/Cyclic	6-6
6.4.6 Acknowledge Handler Class (2Bh)	6-6
6.4.7 Manufacturer Specific Classes (64h, 65h and 66h)	6-6

7	STARTUP GUIDE	7-1
7.1	INSTALLING THE ACCESSORY	7-1
7.2	CONFIGURING THE EQUIPMENT	7-1
7.3	CONFIGURING THE MASTER	7-1
7.4	COMMUNICATION STATUS	7-2
7.5	OPERATION USING PROCESS DATA	7-2
7.6	ACCESS TO PARAMETERS – ACYCLIC MESSAGES	7-2
8	FAULTS AND ALARMS	8-1
9	QUICK REFERENCES	9-1
9.1	PARAMETER STRUCTURE	9-1
9.2	PARAMETERS	9-3

ABOUT THE MANUAL

This manual supplies the necessary information for the operation of the SSW900 soft-starter using the DeviceNet protocol. This manual must be used together with the SSW900 user's manual and programming manual.

ABBREVIATIONS AND DEFINITIONS

ASCII	American Standard Code for Information Interchange
CiA	CAN in Automation
CIP	Common Industrial Protocol
CRC	Cycling Redundancy Check
HMI	Human-Machine Interface
ODVA	Open DeviceNet Vendor Association
PLC	Programmable Logic Controller
ro	Read only
rw	Read/write

NUMERICAL REPRESENTATION

Decimal numbers are represented by means of digits without suffix. Hexadecimal numbers are represented with the letter 'h' after the number. Binary numbers are represented with the letter 'b' after the number.

DOCUMENTS

The DeviceNet protocol was developed based on the following specifications and documents:

Document	Version	Source
CAN Specification	2.0	CiA
Volume One - Common Industrial Protocol (CIP) Specification	3.2	ODVA
Volume Three - DeviceNet Adaptation of CIP	1.4	ODVA
Planning and Installation Manual - DeviceNet Cable System	PUB00027R1	ODVA

In order to obtain this documentation, consult ODVA, which is nowadays the organization that keeps, publishes and updates the information related to the DeviceNet network.

IMPORTANT NOTICE ABOUT CYBERSECURITY AND COMMUNICATIONS

This product/equipment can connect and exchange information through networks and communication protocols. It has been designed and subjected to tests to ensure correct operation with other automation systems using the protocols mentioned in this manual. Therefore, it is essential that the customer understands the responsibilities in connection with information and cybersecurity when using this equipment.

Consequently, it is the exclusive obligation of the customer to adopt in-depth defense strategies and implement policies and measures to ensure the security of the system as a whole, including with regard to communications sent and received by the equipment. Among such measures, we can point out the installation of firewalls, antivirus and malware protection applications, data encryption, authentication control and physical user access.

WEG and its affiliates take no liability for damages or losses arising from cybersecurity breaches, including, but not limited to, unauthorized access, intrusion, information, or data leak and/or theft, denial-of-service attacks, or any other form of security breach. Using this product under conditions for which it was not specifically designed is not recommended and may result in damage to the product, the network, and the automation system. Thus, it is essential that the customer understand that the external intervention by third-party software applications, such as sniffers or applications with similar actions, has the potential to cause interruptions or restrictions in the functionality of the equipment.

TRADEMARKS

DeviceNet is a trademark of ODVA, Inc.

All other trademarks are the property of their respective holders.

1 MAIN CHARACTERISTICS

Below are the main characteristics for communication of the soft-starter SSW900 with DeviceNet accessory.

- Uses the Set of Predefined Master/Slave Connections (Group 2 Only Server).
- It is supplied with an EDS file for the network master configuration.
- Allows up to 50 input words and 20 output words for cyclic data communication.
- Acyclic data available for parameterization (Explicit Messages).

2 INTERFACE DESCRIPTION

The SSW900 soft-starter has two Slots for accessories (Figura 2.1). Parameters S3.5.1 and S3.5.2 present which accessory was recognized by Slot.

The accessories can be connected to any Slot, but only one type of each communication accessory is allowed.

Read the user's manual of the SSW900 soft-starter before installing or using this accessory.

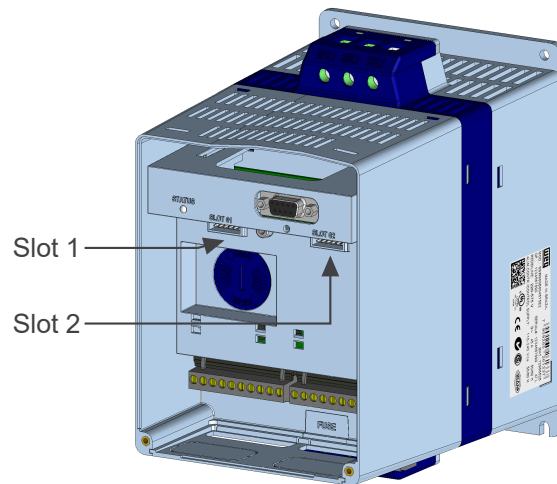
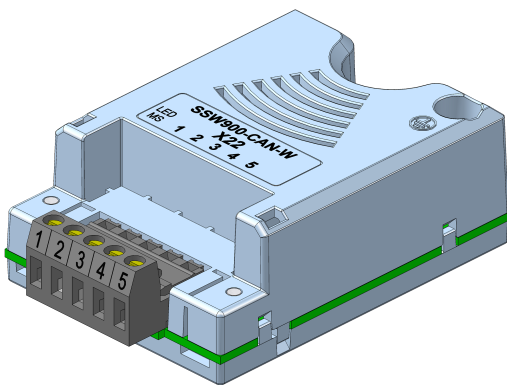

Figure 2.1: Slots for accessories

2.1 DEVICENET ACCESSORY



SSW900-CAN-W:

■ Supplied items:

- Installation guide.
- CANopen/DeviceNet communication module.

2.2 CONNECTOR

The DeviceNet communication module has a 5-wire plug-in connector with the following pin assignment:

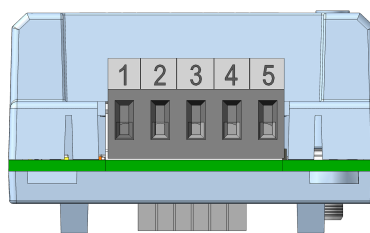

INTERFACE DESCRIPTION

Table 2.1: Pin assignment of connector for DeviceNet interface

Pin	Name	Function
1	V-	Negative pole of the power supply
2	CAN_L	Communication signal CAN_L
3	Shield	Cable shield
4	CAN_H	Communication signal CAN_H
5	V+	Positive pole of the power supply

2.3 POWER SUPPLY

The power supply of the network must be able to supply enough current to power up the equipments and interfaces connected to the network. The data for individual consumption and input voltage are presented in tables 2.2 and 2.3.

Table 2.2: Power Supply (Vdc)

Minimum	Maximum	Recommended
11 V	30 V	24 V

Table 2.3: Current

Typical	Maximum
30 mA	50 mA

2.4 INDICATION LEDS

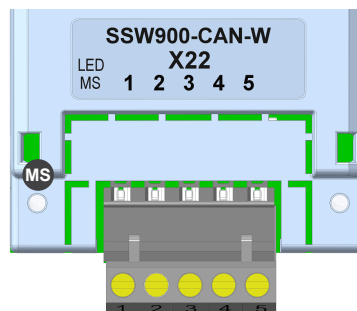

The MS LED indicates the conditions of the module itself. That is, whether it is able to work or not. The table below shows the possible states.

Table 2.4: State of the DeviceNet module

Status	Description	Comments
Off	No power	-
Green	Module operating and in normal conditions	-
Red	Module in error	Reinitializing the equipment is required.
Flashing green/red	Equipment performing self-diagnosis	It occurs during initialization.

3 DEVICENET NETWORK INSTALLATION

The DeviceNet network, such as several industrial communication networks, for being many times applied in aggressive environments with high exposure to electromagnetic interference, requires that certain precautions be taken in order to guarantee a low communication error rate during its operation. Recommendations to perform the connection of the product in this network are presented next.



NOTE!

Detailed recommendations on how to perform the installation are available at document "Planning and Installation Manual" (item DOCUMENTS).

3.1 BAUD RATE

Equipments with DeviceNet interface generally allow the configuration of the desired baud rate, ranging from 125 kbit/s até 500 kbit/s. The baud rate that can be used by the equipment depends on the length of the cable used in the installation. The table 3.1 shows the baud rates and the maximum cable length that can be used in the installation, according to the protocol recommendation.

Table 3.1: Supported baud rates and cable length

Baud Rate	Cable length
125 kbit/s	500 m
250 kbit/s	250 m
500 kbit/s	100 m

All network equipment must be programmed to use the same communication baud rate.

3.2 ADDRESS IN THE DEVICENET NETWORK

Each DeviceNet network device must have an address or MAC ID, and may range from 0 to 63. This address must be unique for each equipment.

3.3 TERMINATION RESISTOR

The use of termination resistors at the ends of the bus is essential to avoid line reflection, which can impair the signal and cause communication errors. Termination resistors of 121 Ω | 0.25 W must be connected between the signals CAN_H and CAN_L at the ends of the main bus.

3.4 CABLE

The connection of CAN_L and CAN_H signals must be done with shielded twisted pair cable. The following table shows the recommended characteristics for the cable.

Table 3.2: DeviceNet cable characteristics

Cable Length (m)	Resistance per Meter (m Ω /m)	Conductor Cross Section (mm ²)
0 ... 40	70	0.25 ... 0.34
40 ... 300	<60	0.34 ... 0.60
300 ... 600	<40	0.50 ... 0.60
600 ... 1000	<26	0.75 ... 0.80

It is necessary to use a twisted pair cable to provide additional 24Vdc power supply to equipments that need this signal. It is recommended to use a certified DeviceNet cable.

3.5 CONNECTION IN THE NETWORK

In order to interconnect the several network nodes, it is recommended to connect the equipment directly to the main line without using derivations. If you use derivations, the limits of length for derivation defined by the

DEVICENET NETWORK INSTALLATION

DeviceNet specification must be observed. During the cable installation the passage near to power cables must be avoided, because, due to electromagnetic interference, this makes the occurrence of transmission errors possible.

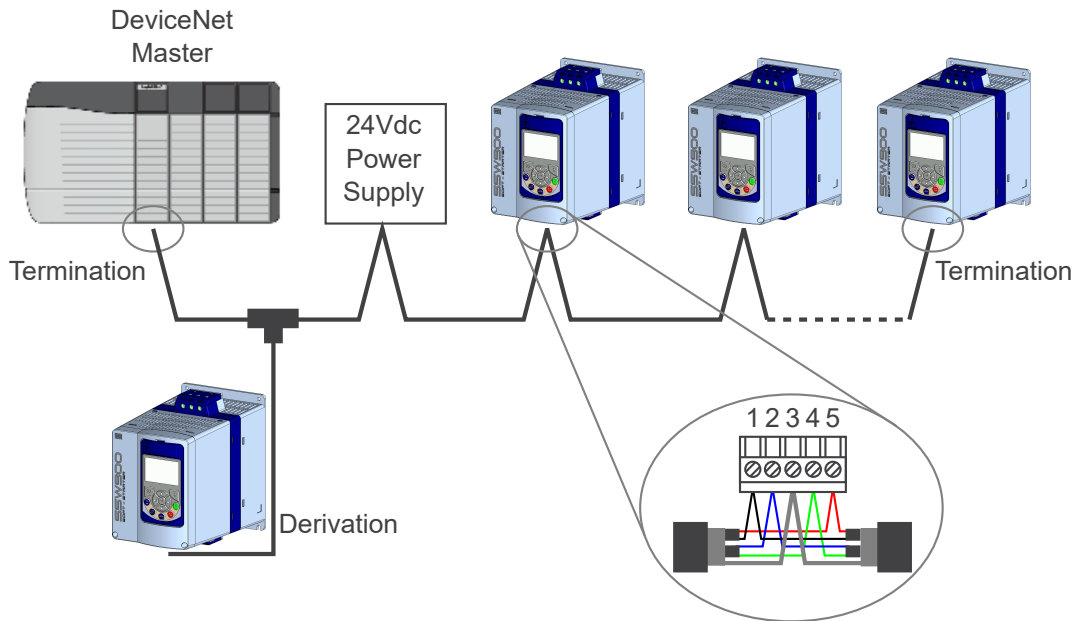

Figure 3.1: DeviceNet network installation example

In order to avoid problems with current circulation caused by difference of potential among ground connections, it is necessary that all the devices be connected to the same ground point.

To avoid voltage difference problems between the power supplies of the network devices, it is recommended that the network is fed by only one power supply and the signal is provided to all devices through the cable. If it is required more than one power supply, these should be referenced to the same point. Use the power supply to power the bus cable system only.

The maximum number of devices connected to a single segment of the network is limited to 64. Repeaters can be used for connecting a bigger number of devices.

4 S STATUS

Allows viewing of the SSW reading variables.

S5 COMMUNICATIONS

HMI monitoring parameters of the communication interfaces.

For a detailed description, refer to the Anybus-CC, CANopen, DeviceNet, Ethernet and Modbus RTU User's Manuals of the SSW according to the interface used.

S5.1 Status Word

.1 SSW 0 ... 15 Bit

Description:

Word of SSW status.

.1 SSW Word of SSW status.

Bit	Value/Description
Bit 0 Running	0: The motor is not enabled. 1: The motor is enabled.
Bit 1 Gener. Enabled	0: When it is general disabled by any mean. 1: When it is general enabled by all the means.
Bit 2 JOG	0: The JOG function is inactive. 1: The JOG function is active.
Bit 3 Initial Test	0: None. 1: During the initial tests before the motor starting.
Bit 4 Ramp Up	0: It is not accelerating. 1: During the whole acceleration.
Bit 5 Full Voltage	0: There is no full voltage applied to the motor. 1: Full voltage is being applied to the motor.
Bit 6 Bypass	0: With open bypass. 1: With closed bypass.
Bit 7 Ramp Down	0: It is not decelerating. 1: During the whole deceleration.
Bit 8 Remote	0: Local. 1: Remote.
Bit 9 Braking	0: It is not executing braking. 1: During the braking process.
Bit 10 FWD/REV	0: It is not reverting the rotation direction. 1: During the rotation reversion process.
Bit 11 Reverse	0: Forward rotation. 1: Reverse rotation.
Bit 12 Ton	0: None. 1: Time before start (C5.7.2).
Bit 13 Toff	0: None. 1: Time after stop (C5.7.3).
Bit 14 Alarm	0: The SSW is not in alarm condition. 1: The SSW is in alarm condition. Note: The active alarm codes can be read by means of the menu D2.1.
Bit 15 Fault	0: The SSW is not in fault condition. 1: The SSW is in fault condition. Note: The active fault code can be read by means of the menu D1.1.

S5.2 Command Word

.5 Slot1 0 ... 15 Bit

.6 Slot2 0 ... 15 Bit

S STATUS

Description:

Command word of all sources of the SSW. The RUN/STOP and JOG commands of the sources which are not active will be reset.

.5 Slot1 Control word via any communication accessory connected to Slot 1.

.6 Slot2 Command word via any communication accessory connected to Slot 2.

Bit	Value/Description
Bit 0 Start/Stop	0 : stopping by ramp. 1 : starting by ramp.
Bit 1 Gener. Enabled	0 : general disable. 1 : general enable.
Bit 2 JOG	0 : no JOG. 1 : with JOG.
Bit 3 FWD/REV	0 : clockwise CW. 1 : counterclockwise CCW.
Bit 4 LOC/REM	0 : local. 1 : remote.
Bit 5 ... 6 Reserved	
Bit 7 Reset	0 → 1 : execute fault reset (if a fault is active). Note: Only in the 0 to 1 transition command.
Bit 8 ... 15 Reserved	



NOTE!

If the RUN/STOP and JOG commands are by a certain source and it is active, only these commands can be viewed in S5.2. For security reasons, all the other commands of the other sources which are not active will be reset.

S5.3 Value for Outputs

.1 DO Value 0 ... 15 Bit

Description:

Value for digital and analog outputs via communication.

.1 DO Value Value for the digital outputs via network interfaces.

Bit	Value/Description
Bit 0 DO1	0 : Inactive. 1 : Active.
Bit 1 DO2	0 : Inactive. 1 : Active.
Bit 2 DO3	0 : Inactive. 1 : Active.
Bit 3 ... 15 Reserved	

S5.3.2 Value for AO

.1 AO in 10 bits 0 ... 1023

Description:

Value for the analog output via network interfaces.

.1 AO in 10 bits Value for the analog output via network interfaces: 0...1023. 0=0% and 1023=100%.

S5.7 CANopen/DeviceNet

.1 CAN Controller Status	0 ... 6
.2 Received Telegram	0 ... 65535
.3 Transmitted Telegram	0 ... 65535
.4 Bus Off Counter	0 ... 65535
.5 Lost Messages	0 ... 65535
.8 DNet Network Status	0 ... 5
.9 DeviceNet Master Status	0 ... 1

Description:

Status of the CAN communication accessory and the protocols that use this interface.

.1 CAN Controller Status It allows identifying if the CAN interface board is properly installed and if the communication presents errors.

Indication	Description
0 = Disabled	Inactive CAN interface. It occurs when CAN protocol is not programmed at C8.4.1.
1 = Auto-baud	CAN controller is trying to detect baud rate of the network (only for DeviceNet communication protocol).
2 = CAN Enabled	CAN interface is active and without errors.
3 = Warning	CAN controller has reached the warning state.
4 = Error Passive	CAN controller has reached the error passive state.
5 = Bus Off	CAN controller has reached the bus off state.
6 = No Bus Power	CAN interface does not have power supply between the pins 1 and 5 of the connector.

.2 Received Telegram This parameter works as a cyclic counter that is incremented every time a CAN telegram is received. It informs the operator if the device is being able to communicate with the network.

.3 Transmitted Telegram This parameter works as a cyclic counter that is incremented every time a CAN telegram is transmitted. It informs the operator if the device is being able to communicate with the network.

.4 Bus Off Counter It is a cyclic counter that indicates the number of times the device entered the bus off state in the CAN network.

.5 Lost Messages It is a cyclic counter that indicates the number of messages received by the CAN interface, but could not be processed by the device. In case that the number of lost messages is frequently incremented, it is recommended to reduce the baud rate used in the CAN network.



NOTE!

This counter is reset every time the device is switched off, a reset is performed or the parameter maximum limit is reached.

.8 DNet Network Status It indicates the status of the DeviceNet network.

Indication	Description
0 = Offline	Device without power supply or not online. Communication cannot be established.
1 = OnLine,NotConn	Device online, but not connected. The slave has successfully completed the MacID verification procedure. This means that the configured baud rate is correct (or it has been detected correctly in case of autobaud) and that there are no other network nodes with the same address. However, there is no communication with the master yet in this stage.
2 = OnLine,Conn	The device is operational and in normal conditions. The master has allocated a set of I/O type connections with the slave. In this stage the effective exchange of data by means of I/O type connections occurs.
3 = Conn.Timed-out	One or more I/O type connections have expired.
4 = Link Failure	It indicates that the slave was not able to enter the network due to addressing problems or due to the occurrence of bus off. Make sure the configured address is not used by other device, verify if the chosen baud rate is correct and make sure there are no installation problems.
5 = Auto-Baud	The equipment is executing the autobaud mechanism.

S STATUS

.9 DeviceNet Master Status It indicates the DeviceNet network master status. It may be in operation mode (Run) or in configuration mode (Idle).

Indication	Description
0 = Run	Reading and writing telegrams are processed normally and updated by the master.
1 = Idle	Only the reading telegrams from the slaves are updated by the master. Writing, in this case, remains disabled.



NOTE!

When communication is disabled this parameter does not represent the actual state of the master.

5 C CONFIGURATIONS

This menu allows the programming of all SSW configuration parameters.

C8 COMMUNICATIONS

To change information via communication network, the SSW has several standard protocols.

The following necessary accessories and protocols are available:

Protocol	Accessory
CANopen	SSW900-CAN-W
DeviceNet	SSW900-CDN-N, SSW900-CAN-W
EtherNet/IP	SSW900-CETH-IP-N, SSW900-CETH-W
Modbus RTU	SSW900-CRS485-W
Modbus TCP	SSW900-CMB-TCP-N, SSW900-CETH-W
Profibus DP	SSW900-CPDP-N
PROFINET IO	SSW900-CPN-IO-N
PROFINET S2	SSW900-CPN-S2-N

For further details regarding the SSW configuration to operate these protocols, refer to the SSW Communication Manual.

C8.1 I/O Data

Configure network data exchange area.

Use this for cyclic communication over SSW900-CAN-W module (DeviceNet), SSW900-CPDP-N, SSW900-CDN-N, SSW900-CETH-IP-N, SSW900-CPN-IO-N and SSW900-CETH-W (EtherNet/IP). For SSW900-CRS485-W using Modbus RTU protocol or modules SSW900-CMB-TCP-N and SSW900-CETH-W using Modbus TCP protocol, a contiguous area of holding registers (@1500-@1549 and @1600-@1619) can be accessed using standard Modbus functions.

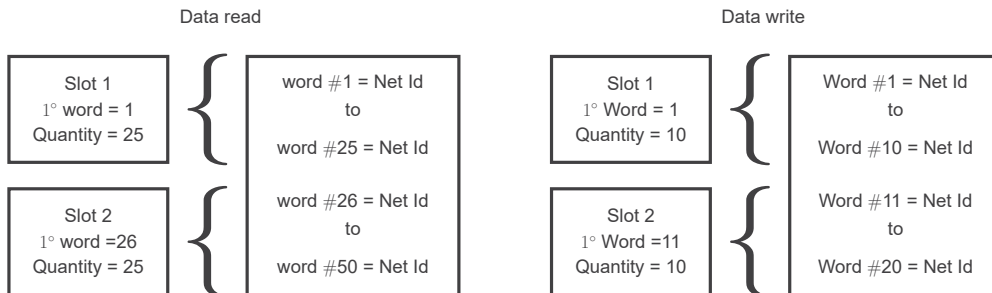

Figure 5.1: Example of data setting

C8.1.1 Data Read

Configure a set of 16 bit parameters to read over the network.

C8.1.1 Data Read		
C8.1.1.1 Slot 1 1st Word		
Range:	1 ... 50	Default: 1
Properties:	Stopped	

Description:

It sets the index of the first programmable read word for data communication (inputs for master).

C CONFIGURATIONS

C8.1.1 Data Read

C8.1.1.2 Slot 1 Quantity

Range:	1 ... 50	Default: 1
Properties:	Stopped	

Description:

It sets the number of read words for data communication (inputs for master), from the first word on.

C8.1.1 Data Read

C8.1.1.3 Slot 2 1st Word

Range:	1 ... 50	Default: 26
Properties:	Stopped	

Description:

It sets the index of the first programmable read word for data communication (inputs for master).

C8.1.1 Data Read

C8.1.1.4 Slot 2 Quantity

Range:	1 ... 50	Default: 1
Properties:	Stopped	

Description:

It set the number of read words for data communication (inputs for master), from the first word on.

C8.1.1 Data Read

C8.1.1.5 Word #1

C8.1.1.5 to C8.1.1.54

C8.1.1 Data Read

C8.1.1.54 Word #50

Range:	0 ... 65535	Default: 0
Properties:	Stopped	

Description:

Select the net address of other parameter, which content will be available as reading data for fieldbus interfaces (inputs: sent to master).

The data size of the referenced parameter must be considered. If data size is bigger than 16 bits, the next data read word configuration must be set to the same net address.

C8.1.2 Data Write

Configure a set of 16 bit parameters to write over the network.

C8.1.2 Data Write

C8.1.2.1 Slot 1 1st Word

Range:	1 ... 20	Default: 1
Properties:	Stopped	

Description:

It sets the index of the first programmable write word for data communication (outputs for master).

C8.1.2 Data Write

C8.1.2.2 Slot 1 Quantity

Range:	1 ... 20	Default: 1
Properties:	Stopped	

Description:

It sets the number of write words for data communication (outputs for master), from the first word on.

C8.1.2 Data Write		
C8.1.2.3 Slot 2 1st Word		
Range:	1 ... 20	Default: 11
Properties:	Stopped	

Description:

It sets the index of the first programmable write word for data communication (outputs for master).

C8.1.2 Data Write		
C8.1.2.4 Slot 2 Quantity		
Range:	1 ... 20	Default: 1
Properties:	Stopped	

Description:

It sets the number of write words for data communication (outputs for master), from the first word on.

C8.1.2 Data Write		
C8.1.2.5 Update Delay		
Range:	0.0 ... 999.9 s	Default: 0.0
Properties:		

Description:

Whenever there is a transition from offline (without cyclic data) to online (with cyclic write data), the data received via communication networks (write words) is ignored during this programmed time, remaining in the state it was before the beginning of the reception.

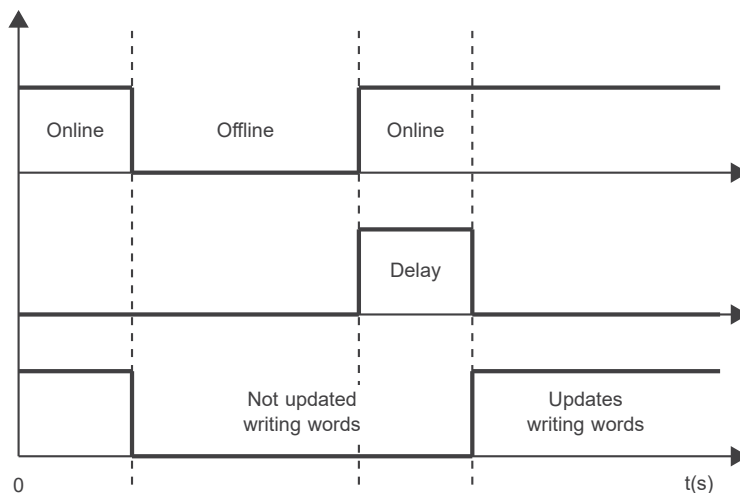

Figure 5.2: Delay in the update of the I/O words

C8.1.2 Data Write		
C8.1.2.6 Word #1		

C8.1.2.6 to C8.1.2.25

C8.1.2 Data Write		
C8.1.2.25 Word #20		
Range:	0 ... 65535	Default: 0
Properties:	Stopped	

C CONFIGURATIONS

Description:

Select the net address of other parameter, which content will be available as writing data for fieldbus interfaces (outputs: received from master).

The data size of the referenced parameter must be considered. If data size is bigger than 16 bits, the next data write word configuration must be set to the same net address.

C8.4 CANopen/DeviceNet

Configuration for the SSW900-CAN-W communication accessory and protocols that use this interface.

C8.4 CANopen/DeviceNet

C8.4.1 Protocol

Range: 0 ... 2 **Default: 2**

Properties:

Description:

It allows selecting the desired protocol for the CAN interface.

Indication	Description
0 = Disabled	Disable CAN interface.
1 = CANopen	Enable CAN interface with CANopen protocol.
2 = DeviceNet	Enable CAN interface with DeviceNet protocol.

C8.4 CANopen/DeviceNet

C8.4.2 Address

Range: 0 ... 127 **Default: 63**

Properties:

Description:

It allows programming the address used for the CAN communication. It is necessary that each element of the network has an address different from the others. The valid addresses for this parameter depend on the protocol programmed in P0700:

- P0700 = 1 (CANopen): valid addresses: 1 to 127.
- P0700 = 2 (DeviceNet): valid addresses: 0 to 63.



NOTE!

After changing this configuration, for the modification to be effective, the change takes effect only if the CAN interface is not exchanging cyclic data with the network.

C8.4 CANopen/DeviceNet

C8.4.3 Baud Rate

Range: 0 ... 8 **Default: 0**

Properties:

Description:

It allows programming the desired baud rate for the CAN interface, in bits per second. This rate must be the same for all the devices connected to the network. The supported baud rates for the device depend on the protocol programmed in the parameter C8.4.1:

- C8.4.1 = 1 (CANopen): It is possible to use any rate specified in this parameter, but it does not have the automatic baud rate detection function – autobaud.
- C8.4.1 = 2 (DeviceNet): only the 500, 250 and 125 Kbit/s rates are supported. Other options will enable the automatic baud rate detection function – autobaud.

After a successful detection, the baud rate parameter (C8.4.3) changes automatically to the detected rate. In order to execute the autobaud function again, it is necessary to change the parameter C8.4.3 to one of the 'Autobaud' options.

Indication	Description
0 = 1 Mbps/Auto	CAN baud rate (automatic detection for DeviceNet).
1 = Reserved	Reserved
2 = 500 Kbps	CAN baud rate.
3 = 250 Kbps	CAN baud rate.
4 = 125 Kbps	CAN baud rate.
5 = 100 Kbps/Auto	CAN baud rate (automatic detection for DeviceNet).
6 = 50 Kbps/Auto	CAN baud rate (automatic detection for DeviceNet).
7 = 20 Kbps/Auto	CAN baud rate (automatic detection for DeviceNet).
8 = 10 Kbps/Auto	CAN baud rate (automatic detection for DeviceNet).



NOTE!

After changing this configuration, for the modification to be effective, the change takes effect only if the CAN interface is not exchanging cyclic data with the network.

C8.4 CANopen/DeviceNet

C8.4.4 Bus Off Reset

Range: 0 ... 1

Default: 1

Properties:

Description:

It allows programming the inverter behavior when detecting a bus off error at the CAN interface.

Indication	Description
0 = Manual	If bus off occurs, the A134/F134 alarm will be indicated on the HMI and the communication will be disabled. In case of alarm, the action programmed in parameter C8.4.5.2 will be executed. In order that the inverter communicates again through the CAN interface, it will be necessary to disable and enable the interface, or reinitiate the device.
1 = Automatic	If bus off occurs, the communication will be reinitiated automatically and the error will be ignored. In this case the alarm will not be indicated on the HMI and the inverter will not execute the action programmed in C8.4.5.2.

C8.4.5 CAN Error

Protection against interruption in the CAN communication.

If for some reason there is an interruption in the CAN communication, a communication error will be indicated, alarm A133...A137 or fault F133...F137 will be shown on the HMI, depending on the programming of C8.4.5.1, and the action programmed in C8.4.5.2 will be executed.

It only occurs after the equipment is online. This error is only generated for the SSW900-CAN-W module.

C CONFIGURATIONS

C8.4.5 CAN Error

C8.4.5.1 Mode

Range: 0 ... 2

Default: 2

Properties:

Description:

It allows configuring the tripping mode of the protection against interruption in the CAN communication.

Indication	Description
0 = Inactive	No tripping.
1 = Fault	Trips as fault. Disables the motor.
2 = Alarm	Trips as alarm. Action described in C8.4.5.2.

C8.4.5 CAN Error

C8.4.5.2 Alarm Action

Range: 0 ... 4

Default: 2

Properties:

Description:

Action for the CAN communication interruption alarm.

The actions described in this parameter are executed through the writing of the respective bits in the control word of the SLOT to which the accessory SSW900-CAN-W is connected. Thus, for the commands to be effective, the equipment must be programmed to be controlled by the network interface used. This programming is done through menu C3.

Indication	Description
0 = Indicates Only	No action is taken; the equipment remains in the current state.
1 = Ramp Stop	The stop by ramp command is executed, and the motor stops according to the programmed deceleration ramp.
2 = General Disable	The equipment is general disabled, and the motor stops by inertia.
3 = Change to LOC	The equipment is commanded to local mode.
4 = Change to REM	The equipment is commanded to remote mode.



NOTE!

The alarm action will only have a function if the error tripping mode C8.4.5.1 is programmed for Alarm.

6 OPERATION IN THE DEVICENET NETWORK

6.1 CYCLIC DATA

Cyclic data is the data normally used for status monitoring and equipment control. For DeviceNet protocol, the interface supports an I/O connection that allows communication up to 50 input words and 20 output words.

It is necessary the configuration to be made both at the slave and master.

6.1.1 Input words

The SSW900 soft-starter has a reading area with 50 16-bit words available for cyclic data exchange of communication networks. The data available in the reading area (Input) is sent to the master of the network. This area is shared between the two Slots.

To map an object in the reading area, follow the steps below.

1. Configure parameter C8.1.1.1 (Slot 1) or C8.1.1.3 (Slot 2). Those parameters indicate which of the reading words starts the input area for the specific Slot.
2. Configure on parameter C8.1.1.2 (Slot 1) or C8.1.1.4 (Slot 2) the quantity of input words which must be transmitted via network.
3. Parameters C8.1.1.5 to C8.1.1.54 enable to configure the data that must be provided on the reading words. Those parameters must contain the network addresses (Net Id) of the data that must be transmitted on the respective reading words. The Net Id list is available on the table 9.2. Consider the size of each parameter mentioned in this list when programming each word.

Example

The example below presents a configuration for Slot 2. Considering the following parameters to be mapped:

- S3.1.3.1 Status Word SSW.
- S1.2.4 Main Line Voltage Average.
- S1.1.4 Current Average.
- S1.5.4 Output Power & P.F. P. F..

Searching parameter information on the table 9.2:

Mapped Parameter	Net Id	Size	Qty Mapped Words	Example Value
S3.1.3.1 Status Word SSW	680	16bit	1	99
S1.2.4 Main Line Voltage Average	4	16bit	1	2186 (218.6 V)
S1.1.4 Current Average	24	32bit	2	23 (2.3 A)
S1.5.4 Output Power & P.F. P. F.	8	8bit	1	14 (0.14)

Therefore, the configuration must be performed as shown below:

1. C8.1.1.3 Data Read Slot 2 1st Word = 26 → first word transmitted via network is the word #26.
2. C8.1.1.4 Data Read Slot 2 Quantity = 5 → sum of the column “Qty mapped words”.
3. Table 6.1 presents the configuration parameters of the words and the content of the reading words.

Table 6.1: Example of configuration of the writing words.

Configuration Parameter	Mapped Parameter	Net Id	Input Area Value
C8.1.1.30 Data Read Word #26	S3.1.3.1	680	0063h
C8.1.1.31 Data Read Word #27	S1.2.4	4	088Ah
C8.1.1.32 Data Read Word #28	S1.1.4	24	0017h (S1.1.4 low word)
C8.1.1.33 Data Read Word #29	S1.1.4	24	0000h (S1.1.4 high word)
C8.1.1.34 Data Read Word #30	S1.5.4	8	000Eh

OPERATION IN THE DEVICENET NETWORK



NOTE!

- Mapping of invalid parameters or not available will return zero value.
- The data is transmitted as an integer value, without the indication of the decimal places.
- To obtain the network address (Net Id) of the parameters and the number of decimal places, refer to the item 9.

6.1.2 Output Words

The SSW900 soft-starter has a writing area with 20 16-bit words available for cyclic data exchange of communication networks. The data available in the write area (Output) is received from the network master. This area is shared between the two Slots.

To map an object in the writing area, follow the steps below.

1. Configure parameter C8.1.2.1 (Slot 1) or C8.1.2.3 (Slot 2). Those parameters indicate which of the writing words starts the output area for the specific Slot.
2. Configure on parameter C8.1.2.2 (Slot 1) or C8.1.2.4 (Slot 2) the quantity of reading words which must be transmitted via network.
3. Parameters C8.1.2.6 to C8.1.2.25 enable to configure the data that must be provided on the writing words. Those parameters must contain the network address (Net Id) of the data that must be transmitted on the respective writing words. The Net Id list is available on the table 9.2. Consider the size of each parameter mentioned in list when programming each word.

Exemplo

The example below presents a configuration for Slot 1. Considering the following parameters to be mapped:

- S5.2.5 Command Word Slot1.
- S5.3.1 Value for Outputs DO Value.
- S5.3.2.1 Value for AO AO in 10 bits.

Searching parameter information on the table 9.2:

Mapped Parameter	Net Id	Size	Qty Mapped Words	Example Value
S5.2.5 Command Word Slot1	685	16bit	1	19 = 0013h
S5.3.1 Value for Outputs DO Value	695	16bit	1	7 = 0007h
S5.3.2.1 Value for AO AO in 10 bits	696	16bit	1	1023 = 03FFh

Therefore, the configuration must be performed as shown below:

1. C8.1.2.1 Data Write Slot 1 1st Word = 1 → first word transmitted via network is the word #1.
2. C8.1.2.2 Data Write Slot 1 Quantity = 3 → sum of column “Qty mapped words”.
3. The table 6.2 presents the configuration parameters of the words and the content of the writing words.

Table 6.2: Example of configuration of the writing words.

Configuration Parameter	Mapped Parameter	Net Id	Output Area Value
C8.1.2.6 Data Write Word #1	S5.2.5	685	0013h
C8.1.2.7 Data Write Word #2	S5.3.1	695	0007h
C8.1.2.8 Data Write Word #3	S5.3.2.1	696	03FFh



NOTE!

- Mapping of readonly parameters (status, diagnostics) or invalid parameters will have no effect.
- Parameters that have the property *Stopped*, when mapped on the writing words, are only changed when the motor is stopped.
- The parameters written using these words are not saved in non-volatile memory. Thus, if the equipment is turned off and back on, these parameters will return to their original value.
- The data is transmitted as an integer value, without the indication of the decimal places.
- To obtain the network address (Net Id) of the parameters, refer to the item 9.

6.2 ACYCLIC DATA

In addition to the cyclic data, the interface also provides acyclic data via explicit messaging. Using this type of communication, you can access any equipment parameter. Access to this type of data is commonly done using instructions for reading or writing data, which should indicate the class, instance, and attribute to the desired parameter. The Manufacturer Specific Classes (64h, 65h and 66h) describe how to address the parameters for SSW900 soft-starter.

6.3 EDS FILE

Each device on an DeviceNet network has an EDS configuration file, which contains information about the device functions on the network. This file is used by a master or configuration software to program devices present at DeviceNet network.

The EDS file is available from WEG website (<http://www.weg.net>). It is important to note if the EDS configuration file is compatible with the firmware version of the SSW900 soft-starter.

6.4 SUPPORTED OBJECT CLASSES

Any DeviceNet equipment is modeled as a set of objects. The objects are responsible for defining the function that each device will have. The following sections present detailed information about these object classes.

6.4.1 Identity Class (01h)

Provides general information about the device identity such as VendorID, Product Name, Serial Number, etc.. The following attributes are implemented:

Table 6.3: Identity Class instance attributes

Attribute	Method	Name	Default	Description
1	GET	Vendor ID	355h	Manufacturer identifier.
2	GET	Device Type	2Bh	Product Type.
3	GET	Product Code	1700h	Product Code.
4	GET	Revision		Firmware revision.
5	GET	Status		Device status.
6	GET	Serial Number		Serial Number.
7	GET	Product Name	SSW900	Product name.

6.4.2 Message Router Class (02h)

Provides information on the explicit message router object. This class does not have any attribute implemented in the SSW900.

OPERATION IN THE DEVICENET NETWORK

6.4.3 DeviceNet Class (03h)

This class is responsible for maintaining the configuration and the state of the physical connections of the DeviceNet node. The following attributes are implemented:

Table 6.4: DeviceNet Class attributes

Atributte	Method	Name	Min/Max	Default	Description
1	GET	Revision	1 - 65535		Revision of the DeviceNet Object Class definition upon which the implementation is based.

Table 6.5: DeviceNet Class instance attributes

Atributte	Method	Name	Min/Max	Default	Description
1	GET/SET	MAC ID	0 - 63	63	Node address.
2	GET/SET	Baud Rate	0 - 2	0	Communication baud rate.
3	GET/SET	Bus-Off Interrupt	0 - 1	1	Bus-off reset.
4	GET/SET	Bus-Off Counter	0 - 255		Bus-off counter.
5	GET	Allocation Information			Information about allocation byte.

6.4.4 Assembly Class (04h)

This class is responsible for grouping several attributes in only one connection. Only the attribute Data (3) is implemented in the SSW900.

Table 6.6: Assembly class instance attributes

Atributte	Method	Name	Description
3	GET	Data	Data contained in the assembly object.

The Assembly class contains the following instances in the SSW900:

Table 6.7: Assembly class instances

Instance	Size	Description
100	2 bytes	Producing Instance.
101	4 bytes	Producing Instance.
...	...	Producing Instance.
149	100 bytes	Producing Instance.
150	2 bytes	Consuming Instance.
151	4 bytes	Consuming Instance.
...	...	Consuming Instance.
169	40 bytes	Consuming Instance.

6.4.5 Connection Class (05h)

This class allocates and manages the internal resources associated with both I/O and Explicit Messaging connections. The following attributes are implemented:

6.4.5.1 Instance 1: Explicit Message

Table 6.8: Connection Class – Instance 1: Explicit Message

Attribute	Method	Name	Description
1	GET	State	Object state.
2	GET	Instance Type	I/O or explicit.
3	GET	Transport Class trigger	Defines the connection behavior.
4	GET	Produced Connection ID	ID field for transmission.
5	GET	Consumed Connection ID	ID field value representing received msg.
6	GET	Initial Comm. Charac.	Defines message groups related to this connection.
7	GET	Produced Connection Size	Maximum size (bytes) of this transmission connection.
8	GET	Consumed Connection Size	Maximum size (bytes) of this reception connection.
9	GET/SET	Expected Packet Rate	Defines timing associated to this connection.
12	GET/SET	Watchdog Timeout Action	Action for inactivity/watchdog timeout.
13	GET	Produced Connection Path Length	Number of bytes in the producer connection.
14	GET	Produced Connection Path	Specifies the path of the data producer objects.
15	GET	Consumed Connection Path Length	Number of bytes in the consumer connection.
16	GET	Consumed Connection Path	Specifies the path of the data consumer objects.
17	GET	Production Inhibit Time	Defines the minimum time between new data production.
18	GET/SET	Connection Timeout Multiplier	

6.4.5.2 Instance 2: Polled

Table 6.9: Connection Class – Instance 2: Polled

Attribute	Method	Name	Description
1	GET	State	Object state.
2	GET	Instance Type	I/O or explicit.
3	GET	Transport Class trigger	Defines the connection behavior.
4	GET	Produced Connection ID	ID field for transmission.
5	GET	Consumed Connection ID	ID field value representing received msg.
6	GET	Initial Comm. Charac.	Defines message groups related to this connection.
7	GET	Produced Connection Size	Maximum size (bytes) of this transmission connection.
8	GET	Consumed Connection Size	Maximum size (bytes) of this reception connection.
9	GET/SET	Expected Packet Rate	Defines timing associated to this connection.
12	GET	Watchdog Timeout Action	Action for inactivity/watchdog timeout.
13	GET	Produced Connection Path Length	Number of bytes in the producer connection.
14	GET	Produced Connection Path	Specifies the path of the data producer objects.
15	GET	Consumed Connection Path Length	Number of bytes in the consumer connection.
16	GET	Consumed Connection Path	Specifies the path of the data consumer objects.
17	GET	Production Inhibit Time	Defines the minimum time between new data production.
18	GET/SET	Connection Timeout Multiplier	

OPERATION IN THE DEVICENET NETWORK

6.4.5.3 Instance 4: Change of State/Cyclic

Table 6.10: Connection Class – Instance 4: Change of State/Cyclic

Attribute	Method	Name	Description
1	GET	State	Object state.
2	GET	Instance Type	I/O or explicit.
3	GET	Transport Class trigger	Defines the connection behavior.
4	GET	Produced Connection ID	ID field for transmission.
5	GET	Consumed Connection ID	ID field value representing received msg.
6	GET	Initial Comm. Charac.	Defines message groups related to this connection.
7	GET	Produced Connection Size	Maximum size (bytes) of this transmission connection.
8	GET	Consumed Connection Size	Maximum size (bytes) of this reception connection.
9	GET/SET	Expected Packet Rate	Defines timing associated to this connection.
12	GET	Watchdog Timeout Action	Action for inactivity/watchdog timeout.
13	GET	Produced Connection Path Length	Number of bytes in the producer connection.
14	GET	Produced Connection Path	Specifies the path of the data producer objects.
15	GET	Consumed Connection Path Length	Number of bytes in the consumer connection.
16	GET	Consumed Connection Path	Specifies the path of the data consumer objects.
17	GET	Production Inhibit Time	Defines the minimum time between new data production.
18	GET/SET	Connection Timeout Multiplier	

6.4.6 Acknowledge Handler Class (2Bh)

This class is responsible for managing the reception of acknowledgment messages.

Table 6.11: Acknowledge Handler Class instance attributes

Attribute	Method	Name
1	GET/SET	Acknowledge Timer
2	GET/SET	Retry Limit
3	GET	COS Production Connection Instance

6.4.7 Manufacturer Specific Classes (64h, 65h and 66h)

The Manufacturer Specific Classes are used for mapping all SSW900 parameters. This classes allow the user to read from and write to any parameter through the network. The Manufacturer Specific Class use DeviceNet explicit messages.



NOTE!

- The data is transmitted as an integer value, without the indication of the decimal places.
- To obtain the class, instance and attribute of each parameter, refer to the item 9.

7 STARTUP GUIDE

The main steps to start up the SSW900 soft-starter in DeviceNet network are described below. These steps represent an example of use. Check out the specific chapters for details on the indicated steps.

7.1 INSTALLING THE ACCESSORY

1. Install the communication accessory, as indicated in the installation guide supplied with the accessory.
2. With the module installed, during the recognition stage, the MS LED test routine will be performed. After this stage, the MS LED must turn on in green.
3. Connect the cable to the accessory, considering the recommended instructions in network installation, as described in item 3.5:
 - Use shielded cable.
 - Properly ground network equipment.
 - Avoid laying communication cables next to power cables.

7.2 CONFIGURING THE EQUIPMENT

1. Follow the recommendations described in the user manual to program the device parameters related to the motor parameterization, desired functions for the I/O signals, etc.
2. Program the command sources as desired for the application in menu C3.
3. Configure communication parameters, such as address and baudrate in C8.4.
4. Program the desired action for the equipment in case of communication fault in C8.4.5.
5. Define which data will be read and written at soft-starter SSW900 using menu C8.1. Among the main parameters that can be used to control the device, we can mention:
 - S3.1.3.1 Status Word SSW (read)
 - S5.2.5 Command Word Slot1 (write)
 - S5.2.6 Command Word Slot2 (write)

7.3 CONFIGURING THE MASTER

The way the network configuration is done depends greatly on the used client and the configuration tool. It is essential to know the tools used to perform this activity. In general, the following steps are necessary to perform the network configuration.

1. Load the EDS file¹ to the list of devices in the network configuration tool.
2. Select SSW900 soft-starter from the available list of devices on the network configuration tool. This can be done manually or automatically, if allowed by the tool.
3. During the configuration of the network, it is necessary to define the quantity of I/O data communicated between master and slave, as well as the transmission method of these data. The DeviceNet protocol defines different methods of data exchange, seeing that the module supports the following methods:

Polled: communication method in which the master sends a telegram to each of the slaves of its list (*scan list*). As soon as it receives the request, the slave immediately answers the request of the master. This process is repeated until all slaves are polled, restarting the cycle.

Change of State: communication method in which the data exchange between master and slave only occurs when there are changes in the values monitored/controlled up to a certain time limit. When this limit is reached, the transmission and reception will take place even if changes have not occurred.

Cyclic: another communication method very similar to the previous one. The only difference is the production and consumption of messages. In this type of communication, every data exchange occurs at regular time intervals, no matter if they have been changed or not.

¹The EDS file is available from WEG website (<http://www.weg.net>). It is important to note if the EDS configuration file is compatible with the firmware version of the SSW900 soft-starter.

Once configured, the network status S5.7.8 indicates OnLine,Conn and the master status S5.7.9 indicates Run. It is in this condition that cyclic data exchange effectively occurs between the slave and the master of the network.

7.4 COMMUNICATION STATUS

Once the network is assembled and the client programmed, it is possible to use the MS LED and parameters of the equipment to identify some status related to the communication.

- The MS LED provide information about the status of the interface.
- The parameters S5.7.8 and S5.7.9 indicate the status of communication between the device and the network master.

The master of the network must also supply information about the communication with the slave.

7.5 OPERATION USING PROCESS DATA

Once the communication is established, the data mapped in the I/O area is automatically updated between master and slave. Among the main parameters that can be used to control the device, we can mention:

- S3.1.3.1 Status Word SSW
- S5.2.5 Command Word Slot1
- S5.2.6 Command Word Slot2

It is important to know these parameters to program the master as desired for the application.

7.6 ACCESS TO PARAMETERS – ACYCLIC MESSAGES

Besides the I/O data (cyclic) communication, the DeviceNet protocol also defines a kind of acyclic telegram (*explicit messages*), used especially in asynchronous tasks, such as parameter setting and configuration of the equipment.

The EDS file provides the full parameter list of the equipment, which can be accessed via *explicit messages*. The item 6.2 how to address the parameters of the soft-starter SSW900 via acyclic messages.

8 FAULTS AND ALARMS

Fault/Alarm	Description	Possible Causes
F133/A133: CAN Interface without Power Supply	It indicates that the CAN interface does not have power supply between the pins 1 and 5 of the connector. It actuates when the CAN interface is connected to the power supply and the absence of power is detected.	<ul style="list-style-type: none"> ■ Measure the voltage between the pins 1 and 5 of the CAN interface connector. ■ Verify if the power supply cables have not been changed or inverted. ■ Make sure there is no contact problem in the cable or in the CAN interface connector.
F134/A134: Bus Off	The bus off error in the CAN interface has been detected. If the number of reception or transmission errors detected by the CAN interface is too high, the CAN controller can be taken to the bus off state, where it interrupts the communication and disables the CAN interface. In order that the communication be reestablished, it will be necessary to cycle the power of the product, or remove the power supply from the CAN interface and apply it again, so that the communication be reinitiated.	<ul style="list-style-type: none"> ■ Verify if there is any short-circuit between the CAN circuit transmission cables. ■ Verify if the cables have not been changed or inverted. ■ Verify if all the network devices use the same baud rate. ■ Verify if termination resistors with the correct values were installed only at the extremes of the main bus. ■ Verify if the CAN network installation was carried out in proper manner.
F136/A136: Idle Master	It actuates when communicating with the master of the DeviceNet network in Run mode and a transition to Idle mode is detected.	<ul style="list-style-type: none"> ■ Adjust the switch that commands the master operation mode for execution (Run) or set the correspondent bit in the configuration word of the master software. In case of doubts, referer to used master documentation.
F137/A137: DeviceNet Connection Timeout	It indicates that one or more DeviceNet I/O connections have expired. It occurs when, for any reason, after the cyclic communication of the master with the product is started, this communication is interrupted.	<ul style="list-style-type: none"> ■ Check the status of the network master. ■ Check the network installation, broken cable or failed/bad contact in the network connections.

9 QUICK REFERENCES

9.1 PARAMETER STRUCTURE

Level 1	Level 2	Level 3	Page	
S Status	S1 Measurements	S1.1 Current	9-3	
		S1.2 Main Line Voltage		
		S1.3 Output Voltage		
		S1.4 SCR Blocking Voltage		
		S1.5 Output Power & P.F.		
		S1.6 P.L.L.		
S2 I/O	S2.1 Digital	S2.2 Analog Output	9-4	
				S2.1 Digital
S3 SSW900	S3.1 SSW Status	S3.2 Software Version	9-4	
				S3.3 SSW Model
				S3.4 Fan Status
				S3.5 Accessories
				S3.5 Accessories
S4 Temperatures	S4.1 SCRs Temperature	S4.2 Thermal Class Status	9-7	
				S4.2 Thermal Class Status
				S4.3 Motor Temperature
S5 Communications	S5.1 Status Word	S5.2 Command Word	9-7	
				S5.3 Value for Outputs
				S5.4 RS485 Serial
				S5.5 Anybus-CC
				S5.6 Configuration Mode
				S5.7 CANopen/DeviceNet
				S5.8 Ethernet
				S5.9 Bluetooth
				S5.9 Bluetooth
S6 SoftPLC	S6.1 SoftPLC Status	S6.2 Scan Cycle Time	9-12	
				S6.2 Scan Cycle Time
				S6.3 Value for Outputs
				S6.4 Parameter
D Diagnostics	D1 Fault	D1.1 Actual	9-14	
		D1.2 Fault History		
	D2 Alarms	D2.1 Actual	9-14	
		D2.2 Alarm History		
	D3 Events	D4.1 Start Current	9-14	
	D4 Motor On			D4.2 Real Start Time
				D4.3 Current Full Voltage
				D4.4 Main Line Voltage
				D4.5 Main Line Frequency
				D4.6 kWh Counter
				D4.7 Number Start
	D5 Temperatures	D5.1 SCRs Maximum	9-14	
		D5.2 Motor Maximum		
	D6 Hours Control		9-15	
D7 Changed Parameters		9-15		

QUICK REFERENCES

Level 1	Level 2	Level 3	Page	
C Configurations	C1	Starting and Stopping	9-15	
	C2	Nominal Motor Data	9-16	
	C3	LOC/REM Selection	9-16	
	C4	I/O	9-16	
			C4.1 Digital Inputs	
			C4.2 Digital Outputs	
			C4.3 Analog Output	
	C5	Protections	9-20	
			C5.1 Voltage Protections	
			C5.2 Current Protections	
			C5.3 Torque Protections	
			C5.4 Power Protections	
			C5.5 Phase Sequence	
			C5.6 Bypass Protections	
			C5.7 Time Protections	
			C5.8 Motor Thermal Protection	
		C5.9 Motor Thermal Class		
		C5.10 SSW Short Circuit		
		C5.11 Fault Auto-Reset		
C6	HMI	9-27		
		C6.1 Password		
		C6.2 Language		
		C6.3 Date and Time		
		C6.4 Main Screen		
		C6.5 LCD Display		
		C6.6 Communication Timeout		
C7	Special Functions	9-28		
		C7.1 Forward/Reverse		
		C7.2 Kick Start		
		C7.3 Jog		
		C7.4 Braking		
C8	Communications	9-28		
		C8.1 I/O Data		
		C8.2 RS485 Serial		
		C8.3 Anybus-CC		
		C8.4 CANopen/DeviceNet		
		C8.5 Ethernet		
		C8.6 Bluetooth		
C9	SSW900	9-35		
		C9.1 Nominal Data		
		C9.2 Types of Connections		
		C9.3 Accessories Config.		
		C9.4 Fan Configuration		
C10	Load / Save Parameters	9-37		
		C10.1 Load / Save User		
		C10.2 Copy Function HMI		
		C10.3 Erase Diagnostics		
		C10.4 Load Factory Default		
		C10.5 Save Changed Param.		
C11	SoftPLC	9-38		
		C11.3 Parameter		
A Assistant	A1 Oriented Start-up	9-39		

9.2 PARAMETERS

Table 9.2: Characteristics of the parameters for the communication protocol

Parameter	Description	Range of values	Decimal places	Class	Instance	Attribute	CIP data type	Net Id	Size	Qty mapped words
S1 Status\Measurements										
S1.1	Current									
S1.1.1	R Phase	0.0 to 14544.0 A	1	64h	01h	7Eh	UDINT	26	32bit	2
S1.1.2	S Phase	0.0 to 14544.0 A	1	64h	01h	80h	UDINT	28	32bit	2
S1.1.3	T Phase	0.0 to 14544.0 A	1	64h	01h	82h	UDINT	30	32bit	2
S1.1.4	Average	0.0 to 14544.0 A	1	64h	01h	7Ch	UDINT	24	32bit	2
S1.1.5	Motor %In	0.0 to 999.9 %	1	64h	01h	66h	UINT	2	16bit	1
S1.1.6	SSW %In	0.0 to 999.9 %	1	64h	01h	65h	UINT	1	16bit	1
S1.2	Main Line Voltage									
S1.2.1	R-S Line	0.0 to 999.9 V	1	64h	01h	85h	UINT	33	16bit	1
S1.2.2	S-T Line	0.0 to 999.9 V	1	64h	01h	86h	UINT	34	16bit	1
S1.2.3	T-R Line	0.0 to 999.9 V	1	64h	01h	87h	UINT	35	16bit	1
S1.2.4	Average	0.0 to 999.9 V	1	64h	01h	68h	UINT	4	16bit	1
S1.2.5	Motor %Vn	0.0 to 999.9 %	1	64h	01h	67h	UINT	3	16bit	1
S1.2.6	SSW %Vn	0.0 to 999.9 %	1	64h	01h	69h	UINT	5	16bit	1
S1.3	Output Voltage									
S1.3.1	Average	0.0 to 999.9 V	1	64h	01h	6Bh	UINT	7	16bit	1
S1.3.2	Motor %Vn	0.0 to 999.9 %	1	64h	01h	6Ah	UINT	6	16bit	1
S1.4	SCR Blocking Voltage									
S1.4.1	R-U Blocking	0.0 to 999.9 V	1	64h	01h	79h	UINT	21	16bit	1
S1.4.2	S-V Blocking	0.0 to 999.9 V	1	64h	01h	7Ah	UINT	22	16bit	1
S1.4.3	T-W Blocking	0.0 to 999.9 V	1	64h	01h	7Bh	UINT	23	16bit	1
S1.5	Output Power & P.F.									
S1.5.1	Active	0.0 to 11700.0 kW	1	64h	01h	6Eh	UDINT	10	32bit	2
S1.5.2	Apparent	0.0 to 11700.0 kVA	1	64h	01h	70h	UDINT	12	32bit	2
S1.5.3	Reactive	0.0 to 11700.0 kVAr	1	64h	01h	72h	UDINT	14	32bit	2
S1.5.4	P. F.	0.00 to 1.00	2	64h	01h	6Ch	USINT	8	8bit	1
S1.6	P.L.L.									
S1.6.1	Status	0 = Off 1 = Ok		64h	01h	74h	USINT	16	enum	1
S1.6.2	Frequency	0.0 to 99.9 Hz	1	64h	01h	75h	UINT	17	16bit	1
S1.6.3	Sequence	0 = Invalid 1 = RST / 123 2 = RTS / 132		64h	01h	76h	USINT	18	enum	1
S1.7	Motor Torque									
S1.7.1	Motor %Tn	0.0 to 999.9 %	1	64h	01h	6Dh	UINT	9	16bit	1

Parameter	Description	Range of values	Decimal places	Class	Instance	Attribute	CIP data type	Net Id	Size	Qty mapped words
S1.8	Control Voltage									
S1.8.1	Input	0.0 to 999.9 V	1	64h	01h	ABh	UINT	71	16bit	1
S1.8.2	+5V	0.00 to 9.99 V	2	64h	01h	ACh	UINT	72	16bit	1
S1.8.3	+12V	0.0 to 99.9 V	1	64h	01h	ADh	UINT	73	16bit	1
S1.8.4	+Vbat	0.00 to 9.99 V	2	64h	01h	AFh	UINT	75	16bit	1
S1.8.5	+48V	0.0 to 99.9 V	1	64h	01h	B0h	UINT	76	16bit	1
S2 Status\I/O										
S2.1	Digital									
S2.1.1	Inputs	Bit 0 = DI1 Bit 1 = DI2 Bit 2 = DI3 Bit 3 = DI4 Bit 4 = DI5 Bit 5 = DI6 Bit 6 ... 15 = Reserved		64h	07h	B1h	WORD	677	16bit	1
S2.1.2	Outputs	Bit 0 = DO1 Bit 1 = DO2 Bit 2 = DO3 Bit 3 ... 15 = Reserved		64h	07h	B2h	WORD	678	16bit	1
S2.2	Analog Output									
S2.2.1	Percent	0.00 to 100.00 %	2	64h	07h	ADh	UINT	673	16bit	1
S2.2.2	Current	0.000 to 20.000 mA	3	64h	07h	ACh	UINT	674	16bit	1
S2.2.3	Voltage	0.000 to 10.000 V	3	64h	07h	AFh	UINT	675	16bit	1
S2.2.4	10 bits	0 to 1023	0	64h	07h	B0h	UINT	676	16bit	1
S3 Status\SSW900										
S3.1	SSW Status									
S3.1.1	Actual	0 = Ready 1 = Initial Test 2 = Fault 3 = Ramp Up 4 = Full Voltage 5 = Bypass 6 = Reserved 7 = Ramp Down 8 = Braking 9 = FWD/REV 10 = Jog 11 = Start Delay		64h	07h	B3h	USINT	679	enum	1

Parameter	Description	Range of values	Decimal places	Class	Instance	Attribute	CIP data type	Net Id	Size	Qty mapped words
S3.1.2	Active Command Source	12 = Re-start Delay 13 = General Disabled 14 = Configuration 0 = HMI Keys LOC 1 = HMI Keys REM 2 = Dlx LOC 3 = Dlx REM 4 = USB LOC 5 = USB REM 6 = SoftPLC LOC 7 = SoftPLC REM 8 = Slot 1 LOC 9 = Slot 1 REM 10 = Slot 2 LOC 11 = Slot 2 REM		64h	03h	84h	USINT	232	enum	1
S3.1.3	Status Word									
S3.1.3.1	SSW	Bit 0 = Running Bit 1 = Gener. Enabled Bit 2 = JOG Bit 3 = Initial Test Bit 4 = Ramp Up Bit 5 = Full Voltage Bit 6 = Bypass Bit 7 = Ramp Down Bit 8 = Remote Bit 9 = Braking Bit 10 = FWD/REV Bit 11 = Reverse Bit 12 = Ton Bit 13 = Toff Bit 14 = Alarm Bit 15 = Fault		64h	07h	B4h	WORD	680	16bit	1
S3.1.4	Configuration Mode									
S3.1.4.1	Status	Bit 0 = System Initialization Bit 1 = Firmware Download Bit 2 = Oriented Start-Up Bit 3 = Incompatible Bit 4 = Reset Needs		64h	07h	C0h	WORD	692	16bit	1

Parameter	Description	Range of values	Decimal places	Class	Instance	Attribute	CIP data type	Net Id	Size	Qty mapped words
		Bit 5 = Copy HMI Bit 6 = Test Mode Bit 7 ... 15 = Reserved								
S3.2	Software Version									
S3.2.1	Package	0.00 to 99.99	2	64h	04h	80h	UINT	328	16bit	1
S3.2.2	Details									
S3.2.2.1	Control 1 V	0.00 to 99.99	2	64h	04h	82h	UINT	330	16bit	1
S3.2.2.2	Control 1 rev.	-32768 to 32767	0	64h	04h	7Fh	INT	327	s16bit	1
S3.2.2.3	Bootloader V	0.00 to 99.99	2	64h	04h	81h	UINT	329	16bit	1
S3.2.2.4	Bootloader rev.	-32768 to 32767	0	64h	04h	7Bh	INT	323	s16bit	1
S3.2.2.5	HMI rev.	-32768 to 32767	0	64h	04h	7Ah	INT	322	s16bit	1
S3.2.2.6	Control 2 V	0.00 to 99.99	2	64h	04h	83h	UINT	331	16bit	1
S3.2.2.7	Control 2 rev.	-32768 to 32767	0	64h	04h	7Eh	INT	326	s16bit	1
S3.2.2.8	Accessory 1 V	0.00 to 99.99	2	64h	04h	85h	UINT	333	16bit	1
S3.2.2.9	Accessory 1 rev.	-32768 to 32767	0	64h	04h	7Ch	INT	324	s16bit	1
S3.2.2.10	Accessory 2 V	0.00 to 99.99	2	64h	04h	86h	UINT	334	16bit	1
S3.2.2.11	Accessory 2 rev.	-32768 to 32767	0	64h	04h	7Dh	INT	325	s16bit	1
S3.3	SSW Model									
S3.3.1	Current	0 = 10 to 30 A 1 = 45 to 105 A 2 = 130 to 200 A 3 = 255 to 412 A 4 = 480 to 670 A 5 = 820 to 950 A 6 = 1100 to 1400 A		64h	03h	C2h	USINT	294	enum	1
S3.3.2	Voltage	0 = 220 to 575 V 1 = 380 to 690 V		64h	03h	C4h	USINT	296	enum	1
S3.3.3	Control Voltage	0 = 110 to 240 V 1 = 110 to 130 V 2 = 220 to 240 V 3 = 24 V		64h	03h	C5h	USINT	297	enum	1
S3.3.4	Serial Number	0 to 4294967295	0	64h	03h	C6h	UDINT	298	32bit	2
S3.4	Fan Status									
S3.4.1	Actual	0 = Off 1 = On		64h	03h	C1h	USINT	293	enum	1
S3.5	Accessories									
S3.5.1	Slot 1			64h	04h	87h	USINT	335	enum	1

Parameter	Description	Range of values	Decimal places	Class	Instance	Attribute	CIP data type	Net Id	Size	Qty mapped words
		0 = Without 1 = Anybus-CC 2 = RS-485 3 = PT100 4 = I/Os Exp. 5 = Profibus 6 = CAN 7 = Ethernet 8 = External Current Acqu.								
S3.5.2	Slot 2	0 = Without 1 = Anybus-CC 2 = RS-485 3 = PT100 4 = I/Os Exp. 5 = Profibus 6 = CAN 7 = Ethernet 8 = External Current Acqu.		64h	04h	88h	USINT	336	enum	1
S4 Status/Temperatures										
S4.1	SCRs Temperature									
S4.1.1	Actual	-22 to 260 °C	0	64h	01h	A0h	INT	60	s16bit	1
S4.2	Thermal Class Status									
S4.2.1	Of Maximum	0.0 to 100.0 %	1	64h	01h	96h	UINT	50	16bit	1
S4.3	Motor Temperature									
S4.3.1	Channel 1	-20 to 260 °C	0	64h	01h	A3h	INT	63	s16bit	1
S4.3.2	Channel 2	-20 to 260 °C	0	64h	01h	A4h	INT	64	s16bit	1
S4.3.3	Channel 3	-20 to 260 °C	0	64h	01h	A5h	INT	65	s16bit	1
S4.3.4	Channel 4	-20 to 260 °C	0	64h	01h	A6h	INT	66	s16bit	1
S4.3.5	Channel 5	-20 to 260 °C	0	64h	01h	A7h	INT	67	s16bit	1
S4.3.6	Channel 6	-20 to 260 °C	0	64h	01h	A8h	INT	68	s16bit	1
S5 Status/Communications										
S5.1	Status Word									
S5.1.1	SSW	Bit 0 = Running Bit 1 = Gener. Enabled Bit 2 = JOG Bit 3 = Initial Test Bit 4 = Ramp Up Bit 5 = Full Voltage Bit 6 = Bypass		64h	07h	B4h	WORD	680	16bit	1

Parameter	Description	Range of values	Decimal places	Class	Instance	Attribute	CIP data type	Net Id	Size	Qty mapped words
		Bit 7 = Ramp Down Bit 8 = Remote Bit 9 = Braking Bit 10 = FWD/REV Bit 11 = Reverse Bit 12 = Ton Bit 13 = Toff Bit 14 = Alarm Bit 15 = Fault								
S5.2	Command Word									
S5.2.1	Dlx	Bit 0 = Start/Stop Bit 1 = Gener. Enabled Bit 2 = JOG Bit 3 = FWD/REV Bit 4 = LOC/REM Bit 5 ... 6 = Reserved Bit 7 = Reset Bit 8 = Brake Bit 9 = Emergency Start Bit 10 ... 15 = Reserved		64h	07h	B7h	WORD	683	16bit	1
S5.2.2	HMI Key	Bit 0 = Start/Stop Bit 1 = Gener. Enabled Bit 2 = JOG Bit 3 = FWD/REV Bit 4 = LOC/REM Bit 5 ... 6 = Reserved Bit 7 = Reset Bit 8 ... 15 = Reserved		64h	07h	B5h	WORD	681	16bit	1
S5.2.3	USB	Bit 0 = Start/Stop Bit 1 = Gener. Enabled Bit 2 = JOG Bit 3 = FWD/REV Bit 4 = LOC/REM Bit 5 ... 6 = Reserved Bit 7 = Reset Bit 8 ... 15 = Reserved		64h	07h	B6h	WORD	682	16bit	1
S5.2.4	SoftPLC	Bit 0 = Start/Stop		64h	07h	B8h	WORD	684	16bit	1

Parameter	Description	Range of values	Decimal places	Class	Instance	Attribute	CIP data type	Net Id	Size	Qty mapped words
		Bit 1 = Gener. Enabled Bit 2 = JOG Bit 3 = FWD/REV Bit 4 = LOC/REM Bit 5 ... 6 = Reserved Bit 7 = Reset Bit 8 ... 15 = Reserved								
S5.2.5	Slot1	Bit 0 = Start/Stop Bit 1 = Gener. Enabled Bit 2 = JOG Bit 3 = FWD/REV Bit 4 = LOC/REM Bit 5 ... 6 = Reserved Bit 7 = Reset Bit 8 ... 15 = Reserved		64h	07h	B9h	WORD	685	16bit	1
S5.2.6	Slot2	Bit 0 = Start/Stop Bit 1 = Gener. Enabled Bit 2 = JOG Bit 3 = FWD/REV Bit 4 = LOC/REM Bit 5 ... 6 = Reserved Bit 7 = Reset Bit 8 ... 15 = Reserved		64h	07h	BAh	WORD	686	16bit	1
S5.3	Value for Outputs									
S5.3.1	DO Value	Bit 0 = DO1 Bit 1 = DO2 Bit 2 = DO3 Bit 3 ... 15 = Reserved		64h	07h	C3h	WORD	695	16bit	1
S5.3.2	Value for AO									
S5.3.2.1	AO in 10 bits	0 to 1023	0	64h	07h	C4h	UINT	696	16bit	1
S5.4	RS485 Serial									
S5.4.1	Interface Status	0 = Off 1 = On 2 = Timeout Error		64h	08h	87h	USINT	735	enum	1
S5.4.2	Received Telegram	0 to 65535	0	64h	08h	88h	UINT	736	16bit	1
S5.4.3	Transmitted Telegram	0 to 65535	0	64h	08h	89h	UINT	737	16bit	1
S5.4.4	Telegram with Error	0 to 65535	0	64h	08h	8Ah	UINT	738	16bit	1

Parameter	Description	Range of values	Decimal places	Class	Instance	Attribute	CIP data type	Net Id	Size	Qty mapped words
S5.4.5	Reception Errors	0 to 65535	0	64h	08h	8Bh	UINT	739	16bit	1
S5.5	Anybus-CC									
S5.5.1	Identification	0 = Disabled 1 ... 15 = Reserved 16 = Profibus DP 17 = DeviceNet 18 = Reserved 19 = EtherNet/IP 20 = Reserved 21 = Modbus TCP 22 = Reserved 23 = PROFINET IO 24 = PROFINET S2 25 = Reserved		64h	08h	96h	USINT	750	enum	1
S5.5.2	Comm. Status	0 = Setup 1 = Init 2 = Wait Comm 3 = Idle 4 = Data Active 5 = Error 6 = Reserved 7 = Exception 8 = Access Error		64h	08h	97h	USINT	751	enum	1
S5.6	Configuration Mode									
S5.6.1	Status	Bit 0 = System Initialization Bit 1 = Firmware Download Bit 2 = Oriented Start-Up Bit 3 = Incompatible Bit 4 = Reset Needs Bit 5 = Copy HMI Bit 6 = Test Mode Bit 7 ... 15 = Reserved		64h	07h	C0h	WORD	692	16bit	1
S5.6.2	Control	Bit 0 = Abort Startup Bit 1 ... 15 = Reserved		64h	07h	C1h	WORD	693	16bit	1
S5.7	CANopen/DeviceNet									
S5.7.1	CAN Controller Status	0 = Disabled		64h	08h	69h	USINT	705	enum	1

Parameter	Description	Range of values	Decimal places	Class	Instance	Attribute	CIP data type	Net Id	Size	Qty mapped words
		1 = Auto-baud 2 = CAN Enabled 3 = Warning 4 = Error Passive 5 = Bus Off 6 = No Bus Power								
S5.7.2	Received Telegram	0 to 65535	0	64h	08h	6Ah	UINT	706	16bit	1
S5.7.3	Transmitted Telegram	0 to 65535	0	64h	08h	6Bh	UINT	707	16bit	1
S5.7.4	Bus Off Counter	0 to 65535	0	64h	08h	6Ch	UINT	708	16bit	1
S5.7.5	Lost Messages	0 to 65535	0	64h	08h	6Dh	UINT	709	16bit	1
S5.7.6	CANopen Comm. Status	0 = Disabled 1 = Reserved 2 = Comm. Enabled 3 = ErrorCtrl.Enab 4 = Guarding Error 5 = HeartbeatError		64h	08h	79h	USINT	721	enum	1
S5.7.7	CANopen Node State	0 = Disabled 1 = Initialization 2 = Stopped 3 = Operational 4 = PreOperational		64h	08h	7Ah	USINT	722	enum	1
S5.7.8	DNet Network Status	0 = Offline 1 = OnLine,NotConn 2 = OnLine,Conn 3 = Conn.Timed-out 4 = Link Failure 5 = Auto-Baud		64h	08h	74h	USINT	716	enum	1
S5.7.9	DeviceNet Master Status	0 = Run 1 = Idle		64h	08h	75h	USINT	717	enum	1
S5.8	Ethernet									
S5.8.1	MBTCP: Communication Status	0 = Disabled 1 = No connection 2 = Connected 3 = Timeout Error		64h	09h	A0h	USINT	860	enum	1
S5.8.2	MBTCP: Active Connections	0 to 4	0	64h	09h	A3h	USINT	863	8bit	1
S5.8.3	EIP Master Status			64h	09h	A9h	USINT	869	enum	1

Parameter	Description	Range of values	Decimal places	Class	Instance	Attribute	CIP data type	Net Id	Size	Qty mapped words
S5.8.4	EIP Communication Status	0 = Run 1 = Idle		64h	09h	AAh	USINT	870	enum	1
S5.8.5	Interface Status	0 = Disabled 1 = No connection 2 = Connected 3 = Timeout in I/O Connection 4 = Duplicated IP		64h	09h	BDh	WORD	889	16bit	1
S5.8.6	Current IP Address	0.0.0.0 to 255.255.255.255		64h	09h	92h	UDINT	846	ip_address	2
S5.9	Bluetooth									
S6 Status\SoftPLC										
S6.1	SoftPLC Status									
S6.1.1	Actual	0 = No Application 1 = Install. App. 2 = Incompat. App. 3 = App. Stopped 4 = App. Running		64h	0Ch	64h	USINT	1100	enum	1
S6.2	Scan Cycle Time									
S6.2.1	Actual	0 to 65535 ms	0	64h	0Ch	66h	UINT	1102	16bit	1
S6.3	Value for Outputs									
S6.3.1	DO Value	Bit 0 = DO1 Bit 1 = DO2 Bit 2 = DO3 Bit 3 ... 15 = Reserved		64h	07h	C5h	WORD	697	16bit	1
S6.3.2	AO Value									
S6.3.2.1	AO in 10 bits	0 to 1023	0	64h	07h	C6h	UINT	698	16bit	1
S6.4	Parameter									
S6.4.1	User #1	-10000 to 10000	0	64h	0Ch	6Eh	DINT	1110	s32bit	2
S6.4.2	User #2	-10000 to 10000	0	64h	0Ch	70h	DINT	1112	s32bit	2
S6.4.3	User #3	-10000 to 10000	0	64h	0Ch	72h	DINT	1114	s32bit	2
S6.4.4	User #4	-10000 to 10000	0	64h	0Ch	74h	DINT	1116	s32bit	2
S6.4.5	User #5	-10000 to 10000	0	64h	0Ch	76h	DINT	1118	s32bit	2
S6.4.6	User #6	-10000 to 10000	0	64h	0Ch	78h	DINT	1120	s32bit	2
S6.4.7	User #7	-10000 to 10000	0	64h	0Ch	7Ah	DINT	1122	s32bit	2
S6.4.8	User #8	-10000 to 10000	0	64h	0Ch	7Ch	DINT	1124	s32bit	2

Parameter	Description	Range of values	Decimal places	Class	Instance	Attribute	CIP data type	Net Id	Size	Qty mapped words
S6.4.9	User #9	-10000 to 10000	0	64h	0Ch	7Eh	DINT	1126	s32bit	2
S6.4.10	User #10	-10000 to 10000	0	64h	0Ch	80h	DINT	1128	s32bit	2
S6.4.11	User #11	-10000 to 10000	0	64h	0Ch	82h	DINT	1130	s32bit	2
S6.4.12	User #12	-10000 to 10000	0	64h	0Ch	84h	DINT	1132	s32bit	2
S6.4.13	User #13	-10000 to 10000	0	64h	0Ch	86h	DINT	1134	s32bit	2
S6.4.14	User #14	-10000 to 10000	0	64h	0Ch	88h	DINT	1136	s32bit	2
S6.4.15	User #15	-10000 to 10000	0	64h	0Ch	8Ah	DINT	1138	s32bit	2
S6.4.16	User #16	-10000 to 10000	0	64h	0Ch	8Ch	DINT	1140	s32bit	2
S6.4.17	User #17	-10000 to 10000	0	64h	0Ch	8Eh	DINT	1142	s32bit	2
S6.4.18	User #18	-10000 to 10000	0	64h	0Ch	90h	DINT	1144	s32bit	2
S6.4.19	User #19	-10000 to 10000	0	64h	0Ch	92h	DINT	1146	s32bit	2
S6.4.20	User #20	-10000 to 10000	0	64h	0Ch	94h	DINT	1148	s32bit	2
S6.4.21	User #21	-10000 to 10000	0	64h	0Ch	96h	DINT	1150	s32bit	2
S6.4.22	User #22	-10000 to 10000	0	64h	0Ch	98h	DINT	1152	s32bit	2
S6.4.23	User #23	-10000 to 10000	0	64h	0Ch	9Ah	DINT	1154	s32bit	2
S6.4.24	User #24	-10000 to 10000	0	64h	0Ch	9Ch	DINT	1156	s32bit	2
S6.4.25	User #25	-10000 to 10000	0	64h	0Ch	9Eh	DINT	1158	s32bit	2
S6.4.26	User #26	-10000 to 10000	0	64h	0Ch	A0h	DINT	1160	s32bit	2
S6.4.27	User #27	-10000 to 10000	0	64h	0Ch	A2h	DINT	1162	s32bit	2
S6.4.28	User #28	-10000 to 10000	0	64h	0Ch	A4h	DINT	1164	s32bit	2
S6.4.29	User #29	-10000 to 10000	0	64h	0Ch	A6h	DINT	1166	s32bit	2
S6.4.30	User #30	-10000 to 10000	0	64h	0Ch	A8h	DINT	1168	s32bit	2
S6.4.31	User #31	-10000 to 10000	0	64h	0Ch	AAh	DINT	1170	s32bit	2
S6.4.32	User #32	-10000 to 10000	0	64h	0Ch	ACh	DINT	1172	s32bit	2
S6.4.33	User #33	-10000 to 10000	0	64h	0Ch	A Eh	DINT	1174	s32bit	2
S6.4.34	User #34	-10000 to 10000	0	64h	0Ch	B0h	DINT	1176	s32bit	2
S6.4.35	User #35	-10000 to 10000	0	64h	0Ch	B2h	DINT	1178	s32bit	2
S6.4.36	User #36	-10000 to 10000	0	64h	0Ch	B4h	DINT	1180	s32bit	2
S6.4.37	User #37	-10000 to 10000	0	64h	0Ch	B6h	DINT	1182	s32bit	2
S6.4.38	User #38	-10000 to 10000	0	64h	0Ch	B8h	DINT	1184	s32bit	2
S6.4.39	User #39	-10000 to 10000	0	64h	0Ch	BAh	DINT	1186	s32bit	2
S6.4.40	User #40	-10000 to 10000	0	64h	0Ch	BCh	DINT	1188	s32bit	2
S6.4.41	User #41	-10000 to 10000	0	64h	0Ch	BEh	DINT	1190	s32bit	2
S6.4.42	User #42	-10000 to 10000	0	64h	0Ch	C0h	DINT	1192	s32bit	2
S6.4.43	User #43	-10000 to 10000	0	64h	0Ch	C2h	DINT	1194	s32bit	2
S6.4.44	User #44	-10000 to 10000	0	64h	0Ch	C4h	DINT	1196	s32bit	2
S6.4.45	User #45	-10000 to 10000	0	64h	0Ch	C6h	DINT	1198	s32bit	2
S6.4.46	User #46	-10000 to 10000	0	64h	0Dh	64h	DINT	1200	s32bit	2
S6.4.47	User #47	-10000 to 10000	0	64h	0Dh	66h	DINT	1202	s32bit	2
S6.4.48	User #48	-10000 to 10000	0	64h	0Dh	68h	DINT	1204	s32bit	2
S6.4.49	User #49	-10000 to 10000	0	64h	0Dh	6Ah	DINT	1206	s32bit	2
S6.4.50	User #50	-10000 to 10000	0	64h	0Dh	6Ch	DINT	1208	s32bit	2

Parameter	Description	Range of values	Decimal places	Class	Instance	Attribute	CIP data type	Net Id	Size	Qty mapped words
D1 Diagnostics\Fault										
D1.1	Actual									
D1.1.1	Fxxx	0 to 999	0	64h	01h	BEh	UINT	90	16bit	1
D1.2	Fault History									
D2 Diagnostics\Alarms										
D2.1	Actual									
D2.1.1	Axxx 1	0 to 999	0	64h	01h	BFh	UINT	91	16bit	1
D2.1.2	Axxx 2	0 to 999	0	64h	01h	C0h	UINT	92	16bit	1
D2.1.3	Axxx 3	0 to 999	0	64h	01h	C1h	UINT	93	16bit	1
D2.1.4	Axxx 4	0 to 999	0	64h	01h	C2h	UINT	94	16bit	1
D2.1.5	Axxx 5	0 to 999	0	64h	01h	C3h	UINT	95	16bit	1
D2.2	Alarm History									
D3 Diagnostics\Events										
D4 Diagnostics\Motor On										
D4.1	Start Current									
D4.1.1	Maximum	0.0 to 14544.0 A	1	64h	01h	88h	UDINT	36	32bit	2
D4.1.2	Average	0.0 to 14544.0 A	1	64h	01h	8Ah	UDINT	38	32bit	2
D4.2	Real Start Time									
D4.2.1	Actual	0 to 999 s	0	64h	01h	94h	UINT	48	16bit	1
D4.2.2	Final	0 to 999 s	0	64h	01h	95h	UINT	49	16bit	1
D4.3	Current Full Voltage									
D4.3.1	Maximum	0.0 to 14544.0 A	1	64h	01h	8Ch	UDINT	40	32bit	2
D4.4	Main Line Voltage									
D4.4.1	Maximum	0.0 to 999.9 V	1	64h	01h	9Ah	UINT	54	16bit	1
D4.4.2	Minimum	0.0 to 999.9 V	1	64h	01h	9Bh	UINT	55	16bit	1
D4.5	Main Line Frequency									
D4.5.1	Maximum	0.0 to 99.9 Hz	1	64h	01h	9Ch	UINT	56	16bit	1
D4.5.2	Minimum	0.0 to 99.9 Hz	1	64h	01h	9Dh	UINT	57	16bit	1
D4.6	kWh Counter									
D4.6.1	Total	0.0 to 429496729.5 kWh	1	64h	01h	98h	UDINT	52	32bit	2
D4.7	Number Start									
D4.7.1	Total	0 to 65535	0	64h	01h	9Fh	UINT	59	16bit	1
D5 Diagnostics\Temperatures										
D5.1	SCRs Maximum									
D5.1.1	Total	-22 to 260 °C	0	64h	01h	B1h	INT	77	s16bit	1
D5.2	Motor Maximum									
D5.2.1	Channel 1	-20 to 260 °C	0	64h	01h	B4h	INT	80	s16bit	1
D5.2.2	Channel 2	-20 to 260 °C	0	64h	01h	B5h	INT	81	s16bit	1
D5.2.3	Channel 3	-20 to 260 °C	0	64h	01h	B6h	INT	82	s16bit	1
D5.2.4	Channel 4	-20 to 260 °C	0	64h	01h	B7h	INT	83	s16bit	1

Parameter	Description	Range of values	Decimal places	Class	Instance	Attribute	CIP data type	Net Id	Size	Qty mapped words
D5.2.5	Channel 5	-20 to 260 °C	0	64h	01h	B8h	INT	84	s16bit	1
D5.2.6	Channel 6	-20 to 260 °C	0	64h	01h	B9h	INT	85	s16bit	1
D6 Diagnostics\Hours Control										
D6.1	Powered	0 to 4294967295 s	0	64h	01h	8Eh	UDINT	42	TIME	2
D6.2	Enabled	0 to 4294967295 s	0	64h	01h	90h	UDINT	44	TIME	2
D6.3	Fan ON	0 to 4294967295 s	0	64h	01h	92h	UDINT	46	TIME	2
D7 Diagnostics\Changed Parameters C1 Configurations\Starting and Stopping										
C1.1	Types of Control	0 = Voltage Ramp 1 = Voltage Ramp + Current Limit 2 = Current Limit 3 = Current Ramp 4 = Pump Control 5 = Torque Control 6 = D.O.L. SCR		64h	03h	66h	USINT	202	enum	1
C1.2	Initial Start Voltage	25 to 90 %	0	64h	02h	65h	USINT	101	8bit	1
C1.3	Maximum Start Time	1 to 999 s	0	64h	02h	66h	UINT	102	16bit	1
C1.4	Start End Detection	0 = Time 1 = Automatic		64h	02h	6Ah	USINT	106	enum	1
C1.5	Initial Current Ramp	150 to 600 %	0	64h	02h	6Fh	UINT	111	16bit	1
C1.6	Current Ramp Time	1 to 99 %	0	64h	02h	70h	USINT	112	8bit	1
C1.7	Current Limit	150 to 600 %	0	64h	02h	6Eh	UINT	110	16bit	1
C1.8	Start Torque Chara.	1 = Constant 2 = Linear 3 = Square		64h	02h	78h	USINT	120	enum	1
C1.9	Initial Start Torque	10 to 300 %	0	64h	02h	79h	UINT	121	16bit	1
C1.10	End Start Torque	10 to 300 %	0	64h	02h	7Ah	UINT	122	16bit	1
C1.11	Minimum Start Torque	10 to 300 %	0	64h	02h	7Bh	UINT	123	16bit	1
C1.12	Min.Start Torq. Time	1 to 99 %	0	64h	02h	7Ch	USINT	124	8bit	1
C1.13	Stop Time	0 to 999 s	0	64h	02h	68h	UINT	104	16bit	1
C1.14	Step Down Volt. Stop	60 to 100 %	0	64h	02h	67h	USINT	103	8bit	1
C1.15	End Voltage Stop	30 to 55 %	0	64h	02h	69h	USINT	105	8bit	1
C1.16	Stop Torque Characte.	1 = Constant 2 = Linear 3 = Square		64h	02h	7Dh	USINT	125	enum	1
C1.17	End Stop Torque	10 to 100 %	0	64h	02h	7Eh	USINT	126	8bit	1
C1.18	Minimum Stop Torque	10 to 100 %	0	64h	02h	7Fh	USINT	127	8bit	1
C1.19	Min. Stop Torque Time	1 to 99 %	0	64h	02h	80h	USINT	128	8bit	1

Parameter	Description	Range of values	Decimal places	Class	Instance	Attribute	CIP data type	Net Id	Size	Qty mapped words
C4.1.1	DI1	0 = Not Used 1 = Start / Stop 2 = Start (3 Wires) 3 = Stop (3 Wires) 4 = General Enable 5 = LOC / REM 6 = JOG 7 = FWD / REV 8 = No External Fault 9 = No External Alarm 10 = Brake 11 = Reset 12 = Load User 1/2 13 ... 16 = Reserved		64h	03h	A3h	USINT	263	enum	1
C4.1.2	DI2	0 = Not Used 1 = Start / Stop 2 = Start (3 Wires) 3 = Stop (3 Wires) 4 = General Enable 5 = LOC / REM 6 = JOG 7 = FWD / REV 8 = No External Fault 9 = No External Alarm 10 = Brake 11 = Reset 12 = Load User 1/2 13 ... 16 = Reserved		64h	03h	A4h	USINT	264	enum	1
C4.1.3	DI3	0 = Not Used 1 = Start / Stop 2 = Start (3 Wires) 3 = Stop (3 Wires) 4 = General Enable 5 = LOC / REM 6 = JOG 7 = FWD / REV 8 = No External Fault 9 = No External Alarm 10 = Brake		64h	03h	A5h	USINT	265	enum	1

Parameter	Description	Range of values	Decimal places	Class	Instance	Attribute	CIP data type	Net Id	Size	Qty mapped words
		11 = Reset 12 = Load User 1/2 13 = Reserved 14 = Emergency Start 15 ... 16 = Reserved								
C4.1.4	DI4	0 = Not Used 1 = Start / Stop 2 = Start (3 Wires) 3 = Stop (3 Wires) 4 = General Enable 5 = LOC / REM 6 = JOG 7 = FWD / REV 8 = No External Fault 9 = No External Alarm 10 = Brake 11 = Reset 12 = Load User 1/2 13 ... 16 = Reserved		64h	03h	A6h	USINT	266	enum	1
C4.1.5	DI5	0 = Not Used 1 = Start / Stop 2 = Start (3 Wires) 3 = Stop (3 Wires) 4 = General Enable 5 = LOC / REM 6 = JOG 7 = FWD / REV 8 = No External Fault 9 = No External Alarm 10 = Brake 11 = Reset 12 = Load User 1/2 13 ... 16 = Reserved		64h	03h	A7h	USINT	267	enum	1
C4.1.6	DI6	0 = Not Used 1 = Start / Stop 2 = Start (3 Wires) 3 = Stop (3 Wires) 4 = General Enable 5 = LOC / REM		64h	03h	A8h	USINT	268	enum	1

Parameter	Description	Range of values	Decimal places	Class	Instance	Attribute	CIP data type	Net Id	Size	Qty mapped words
		6 = JOG 7 = FWD / REV 8 = No External Fault 9 = No External Alarm 10 = Brake 11 = Reset 12 = Load User 1/2 13 ... 14 = Reserved 15 = Mot. Thermistor A032 16 = Mot. Thermistor F032								
C4.2	Digital Outputs									
C4.2.1	DO1	0 = Not Used 1 = Running 2 = Full Voltage 3 = Bypass 4 = FWD / REV K1 5 = DC Braking 6 = Without Fault 7 = With Fault 8 = Without Alarm 9 = With Alarm 10 = No Fault / Alarm 11 = SoftPLC 12 = Communication 13 = I motor % > Value 14 = Breaker Shunt Trip		64h	03h	AFh	USINT	275	enum	1
C4.2.2	DO2	0 = Not Used 1 = Running 2 = Full Voltage 3 = Bypass 4 = FWD / REV K2 5 = DC Braking 6 = Without Fault 7 = With Fault 8 = Without Alarm 9 = With Alarm 10 = No Fault / Alarm 11 = SoftPLC 12 = Communication 13 = I motor % > Value		64h	03h	B0h	USINT	276	enum	1

Parameter	Description	Range of values	Decimal places	Class	Instance	Attribute	CIP data type	Net Id	Size	Qty mapped words
C4.2.3	DO3	14 = Breaker Shunt Trip 0 = Not Used 1 = Running 2 = Full Voltage 3 = Bypass 4 = Not Used 5 = DC Braking 6 = Without Fault 7 = With Fault 8 = Without Alarm 9 = With Alarm 10 = No Fault / Alarm 11 = SoftPLC 12 = Communication 13 = I motor % > Value 14 = Breaker Shunt Trip		64h	03h	B1h	USINT	277	enum	1
C4.2.4	DO Comparison Value	10.0 to 500.0 %	1	64h	03h	B2h	UINT	278	16bit	1
C4.3	Analog Output									
C4.3.1	Function	0 = Not Used 1 = SSW Current % 2 = Line Voltage % 3 = Output Voltage % 4 = Power Factor 5 = Thermal Class Prot. 6 = Output Power W 7 = Output Power VA 8 = Motor Torque % 9 = Value to AO 10 = SCRs Temperature 11 = SoftPLC		64h	03h	97h	USINT	251	enum	1
C4.3.2	Gain	0.000 to 9.999	3	64h	03h	98h	UINT	252	16bit	1
C4.3.3	Signal	0 = 0 to 20mA 1 = 4 to 20mA 2 = 20mA to 0 3 = 20 to 4mA 4 = 0 to 10V 5 = 10V to 0		64h	03h	99h	USINT	253	enum	1

Parameter	Description	Range of values	Decimal places	Class	Instance	Attribute	CIP data type	Net Id	Size	Qty mapped words
C5.1	Voltage Protections									
C5.1.1	Motor Undervoltage									
C5.1.1.1	Mode	0 = Inactive 1 = Fault F002 2 = Alarm A002		64h	0Ah	64h	USINT	900	enum	1
C5.1.1.2	Level	0 to 30 %Vn	0	64h	0Ah	65h	USINT	901	8bit	1
C5.1.1.3	Time	0.1 to 10.0 s	1	64h	0Ah	66h	USINT	902	8bit	1
C5.1.2	Motor Overvoltage									
C5.1.2.1	Mode	0 = Inactive 1 = Fault F016 2 = Alarm A016		64h	0Ah	67h	USINT	903	enum	1
C5.1.2.2	Level	0 to 20 %Vn	0	64h	0Ah	68h	USINT	904	8bit	1
C5.1.2.3	Time	0.1 to 10.0 s	1	64h	0Ah	69h	USINT	905	8bit	1
C5.1.3	Motor Voltage Imbalance									
C5.1.3.1	Mode	0 = Inactive 1 = Fault F001 2 = Alarm A001		64h	0Ah	6Ah	USINT	906	enum	1
C5.1.3.2	Level	0 to 30 %Vn	0	64h	0Ah	6Bh	USINT	907	8bit	1
C5.1.3.3	Time	0.1 to 10.0 s	1	64h	0Ah	6Ch	USINT	908	8bit	1
C5.2	Current Protections									
C5.2.1	Motor Undercurrent									
C5.2.1.1	Mode	0 = Inactive 1 = Fault F065 2 = Alarm A065		64h	0Ah	6Eh	USINT	910	enum	1
C5.2.1.2	Level	0 to 99 %In	0	64h	0Ah	6Fh	USINT	911	8bit	1
C5.2.1.3	Time	1 to 99 s	0	64h	0Ah	70h	USINT	912	8bit	1
C5.2.2	Motor Overcurrent									
C5.2.2.1	Mode	0 = Inactive 1 = Fault F066 2 = Alarm A066		64h	0Ah	71h	USINT	913	enum	1
C5.2.2.2	Level	0 to 99 %In	0	64h	0Ah	72h	USINT	914	8bit	1
C5.2.2.3	Time	1 to 99 s	0	64h	0Ah	73h	USINT	915	8bit	1
C5.2.3	Current Imbalance									
C5.2.3.1	Mode	0 = Inactive 1 = Fault F074		64h	0Ah	74h	USINT	916	enum	1

Parameter	Description	Range of values	Decimal places	Class	Instance	Attribute	CIP data type	Net Id	Size	Qty mapped words
C5.2.3.2	Level	2 = Alarm A074 0 to 30 %In	0	64h	0Ah	75h	USINT	917	8bit	1
C5.2.3.3	Time	1 to 99 s	0	64h	0Ah	76h	USINT	918	8bit	1
C5.3	Torque Protections									
C5.3.1	Undertorque									
C5.3.1.1	Mode	0 = Inactive 1 = Fault F078 2 = Alarm A078		64h	0Ah	96h	USINT	950	enum	1
C5.3.1.2	Level	0 to 99 %Tn	0	64h	0Ah	97h	USINT	951	8bit	1
C5.3.1.3	Time	1 to 99 s	0	64h	0Ah	98h	USINT	952	8bit	1
C5.3.2	Overtorque									
C5.3.2.1	Mode	0 = Inactive 1 = Fault F079 2 = Alarm A079		64h	0Ah	99h	USINT	953	enum	1
C5.3.2.2	Level	0 to 99 %Tn	0	64h	0Ah	9Ah	USINT	954	8bit	1
C5.3.2.3	Time	1 to 99 s	0	64h	0Ah	9Bh	USINT	955	8bit	1
C5.4	Power Protections									
C5.4.1	Underpower									
C5.4.1.1	Mode	0 = Inactive 1 = Fault F080 2 = Alarm A080		64h	0Ah	A0h	USINT	960	enum	1
C5.4.1.2	Level	0 to 99 %Pn	0	64h	0Ah	A1h	USINT	961	8bit	1
C5.4.1.3	Time	1 to 99 s	0	64h	0Ah	A2h	USINT	962	8bit	1
C5.4.2	Overpower									
C5.4.2.1	Mode	0 = Inactive 1 = Fault F081 2 = Alarm A081		64h	0Ah	A3h	USINT	963	enum	1
C5.4.2.2	Level	0 to 99 %Pn	0	64h	0Ah	A4h	USINT	964	8bit	1
C5.4.2.3	Time	1 to 99 s	0	64h	0Ah	A5h	USINT	965	8bit	1
C5.5	Phase Sequence									
C5.5.1	Mode	0 = Inactive 1 = RST - Fault F067 2 = RTS - Fault F068		64h	0Ah	82h	USINT	930	enum	1
C5.6	Bypass Protections									
C5.6.1	Undercurrent	0 = Inactive		64h	0Ah	77h	USINT	919	enum	1

Parameter	Description	Range of values	Decimal places	Class	Instance	Attribute	CIP data type	Net Id	Size	Qty mapped words
C5.6.2	Overcurrent	1 = Fault F076		64h	0Ah	78h	USINT	920	enum	1
C5.6.3	Closed	0 = Inactive 1 = Fault F063		64h	0Ah	79h	USINT	921	enum	1
C5.7	Time Protections									
C5.7.1	Before Start	0.5 to 999.9 s	1	64h	0Ah	83h	UINT	931	16bit	1
C5.7.2	After Stop	2.0 to 999.9 s	1	64h	0Ah	84h	UINT	932	16bit	1
C5.7.3	Between Start	2 to 9999 s	0	64h	0Ah	85h	UINT	933	16bit	1
C5.8	Motor Thermal Protection									
C5.8.1	Ch1 Installed Sensor									
C5.8.1.1	Mode	0 = Off 1 = On 2 = On Stator		64h	0Bh	6Ah	USINT	1006	enum	1
C5.8.2	Ch1 Sensor Fault									
C5.8.2.1	Mode	0 = Fault F109 and F117 1 = Alarm A109 and A117		64h	0Ah	C6h	USINT	998	enum	1
C5.8.3	Ch1 Overtemperature									
C5.8.3.1	Mode	0 = Fault F101 1 = Alarm A101 2 = F101 and A101		64h	0Ah	A6h	USINT	966	enum	1
C5.8.3.2	Fault Level	0 to 250 °C	0	64h	0Ah	A7h	USINT	967	8bit	1
C5.8.3.3	Alarm Level	0 to 250 °C	0	64h	0Ah	A8h	USINT	968	8bit	1
C5.8.3.4	Alarm Reset	0 to 250 °C	0	64h	0Ah	A9h	USINT	969	8bit	1
C5.8.4	Ch2 Installed Sensor									
C5.8.4.1	Mode	0 = Off 1 = On 2 = On Stator		64h	0Bh	6Bh	USINT	1007	enum	1
C5.8.5	Ch2 Sensor Fault									
C5.8.5.1	Mode	0 = Fault F110 and F118 1 = Alarm A110 and A118		64h	0Ah	C7h	USINT	999	enum	1
C5.8.6	Ch2 Overtemperature									
C5.8.6.1	Mode	0 = Fault F102		64h	0Ah	AAh	USINT	970	enum	1

Parameter	Description	Range of values	Decimal places	Class	Instance	Attribute	CIP data type	Net Id	Size	Qty mapped words
		1 = Alarm A102 2 = F102 and A102								
C5.8.6.2	Fault Level	0 to 250 °C	0	64h	0Ah	ABh	USINT	971	8bit	1
C5.8.6.3	Alarm Level	0 to 250 °C	0	64h	0Ah	ACh	USINT	972	8bit	1
C5.8.6.4	Alarm Reset	0 to 250 °C	0	64h	0Ah	ADh	USINT	973	8bit	1
C5.8.7	Ch3 Installed Sensor									
C5.8.7.1	Mode	0 = Off 1 = On 2 = On Stator		64h	0Bh	6Ch	USINT	1008	enum	1
C5.8.8	Ch3 Sensor Fault									
C5.8.8.1	Mode	0 = Fault F111 and F119 1 = Alarm A111 and A119		64h	0Bh	64h	USINT	1000	enum	1
C5.8.9	Ch3 Overtemperature									
C5.8.9.1	Mode	0 = Fault F103 1 = Alarm A103 2 = F103 and A103		64h	0Ah	A Eh	USINT	974	enum	1
C5.8.9.2	Fault Level	0 to 250 °C	0	64h	0Ah	AFh	USINT	975	8bit	1
C5.8.9.3	Alarm Level	0 to 250 °C	0	64h	0Ah	B0h	USINT	976	8bit	1
C5.8.9.4	Alarm Reset	0 to 250 °C	0	64h	0Ah	B1h	USINT	977	8bit	1
C5.8.10	Ch4 Installed Sensor									
C5.8.10.1	Mode	0 = Off 1 = On 2 = On Stator		64h	0Bh	6Dh	USINT	1009	enum	1
C5.8.11	Ch4 Sensor Fault									
C5.8.11.1	Mode	0 = Fault F112 and F120 1 = Alarm A112 and A120		64h	0Bh	65h	USINT	1001	enum	1
C5.8.12	Ch4 Overtemperature									
C5.8.12.1	Mode	0 = Fault F104 1 = Alarm A104 2 = F104 and A104		64h	0Ah	B2h	USINT	978	enum	1
C5.8.12.2	Fault Level	0 to 250 °C	0	64h	0Ah	B3h	USINT	979	8bit	1
C5.8.12.3	Alarm Level	0 to 250 °C	0	64h	0Ah	B4h	USINT	980	8bit	1
C5.8.12.4	Alarm Reset	0 to 250 °C	0	64h	0Ah	B5h	USINT	981	8bit	1
C5.8.13	Ch5 Installed Sensor									
C5.8.13.1	Mode			64h	0Bh	6Eh	USINT	1010	enum	1

Parameter	Description	Range of values	Decimal places	Class	Instance	Attribute	CIP data type	Net Id	Size	Qty mapped words
		0 = Off 1 = On 2 = On Stator								
C5.8.14	Ch5 Sensor Fault									
C5.8.14.1	Mode	0 = Fault F113 and F121 1 = Alarm A113 and A121		64h	0Bh	66h	USINT	1002	enum	1
C5.8.15	Ch5 Overtemperature									
C5.8.15.1	Mode	0 = Fault F105 1 = Alarm A105 2 = F105 and A105		64h	0Ah	B6h	USINT	982	enum	1
C5.8.15.2	Fault Level	0 to 250 °C	0	64h	0Ah	B7h	USINT	983	8bit	1
C5.8.15.3	Alarm Level	0 to 250 °C	0	64h	0Ah	B8h	USINT	984	8bit	1
C5.8.15.4	Alarm Reset	0 to 250 °C	0	64h	0Ah	B9h	USINT	985	8bit	1
C5.8.16	Ch6 Installed Sensor									
C5.8.16.1	Mode	0 = Off 1 = On 2 = On Stator		64h	0Bh	6Fh	USINT	1011	enum	1
C5.8.17	Ch6 Sensor Fault									
C5.8.17.1	Mode	0 = Fault F114 and F122 1 = Alarm A114 and A122		64h	0Bh	67h	USINT	1003	enum	1
C5.8.18	Ch6 Overtemperature									
C5.8.18.1	Mode	0 = Fault F106 1 = Alarm A106 2 = F106 and A106		64h	0Ah	BAh	USINT	986	enum	1
C5.8.18.2	Fault Level	0 to 250 °C	0	64h	0Ah	BBh	USINT	987	8bit	1
C5.8.18.3	Alarm Level	0 to 250 °C	0	64h	0Ah	BCh	USINT	988	8bit	1
C5.8.18.4	Alarm Reset	0 to 250 °C	0	64h	0Ah	BDh	USINT	989	8bit	1
C5.9	Motor Thermal Class									
C5.9.1	Programming Mode	0 = Standard 1 = Custom		64h	0Ah	86h	USINT	934	enum	1
C5.9.2	Action Mode	0 = Inactive 1 = Fault F005 2 = Alarm A005 3 = F005 and A005		64h	0Ah	87h	USINT	935	enum	1

Parameter	Description	Range of values	Decimal places	Class	Instance	Attribute	CIP data type	Net Id	Size	Qty mapped words
C5.9.3	Alarm Level	0 to 100 %	0	64h	0Ah	88h	USINT	936	8bit	1
C5.9.4	Alarm Reset	0 to 100 %	0	64h	0Ah	89h	USINT	937	8bit	1
C5.9.5	Motor Temperature	0 = T.C. + PT100 1 = T.C. + Th.Im.		64h	0Ah	8Ah	USINT	938	enum	1
C5.9.6	Thermal Class	0 = Automatic 1 = Class 10 2 = Class 15 3 = Class 20 4 = Class 25 5 = Class 30 6 = Class 35 7 = Class 40 8 = Class 45		64h	0Ah	8Bh	USINT	939	enum	1
C5.9.7	Motor Data									
C5.9.7.1	Insulation Class	0 = Class A 105°C 1 = Class E 120°C 2 = Class B 130°C 3 = Class F 155°C 4 = Class H 180°C 5 = Class N 200°C 6 = Class R 220°C 7 = Class S 240°C 8 = Class 250°C		64h	0Ah	8Ch	USINT	940	enum	1
C5.9.7.2	Temperature Rise	0 to 200 °C	0	64h	0Ah	8Eh	USINT	942	8bit	1
C5.9.7.3	Ambient Temperature	0 to 200 °C	0	64h	0Ah	8Dh	USINT	941	8bit	1
C5.9.7.4	Locked Rotor Time	1 to 100 s	0	64h	0Ah	8Fh	USINT	943	8bit	1
C5.9.7.5	Locked Rotor Current	2.0 to 10.0 x	1	64h	0Ah	90h	USINT	944	8bit	1
C5.9.7.6	Heating Time Constant	1 to 2880 min	0	64h	0Ah	91h	UINT	945	16bit	1
C5.9.7.7	Cooling Time Constant	1 to 8640 min	0	64h	0Ah	92h	UINT	946	16bit	1
C5.9.8	Thermal Image									
C5.9.8.1	Reset	0 to 8640 min	0	64h	0Ah	93h	UINT	947	16bit	1
C5.10	SSW Short Circuit									
C5.10.1	Motor Off	0 = Inactive 1 = Fault F019		64h	0Ah	7Ah	USINT	922	enum	1
C5.10.2	Motor On	0 = Inactive 1 = Fault F020		64h	0Ah	7Bh	USINT	923	enum	1

Parameter	Description	Range of values	Decimal places	Class	Instance	Attribute	CIP data type	Net Id	Size	Qty mapped words
C5.11	Fault Auto-Reset									
C5.11.1	Mode	0 = Off 1 = On		64h	03h	6Bh	USINT	207	enum	1
C5.11.2	Time	3 to 600 s	0	64h	03h	6Ch	UINT	208	16bit	1
C6 Configurations\HMI										
C6.1	Password									
C6.1.1	Password	0 to 9999	0	64h	03h	6Eh	UINT	210	16bit	1
C6.1.2	Password Options	0 = Off 1 = On 2 = Change Password		64h	03h	64h	USINT	200	enum	1
C6.2	Language									
C6.2.1	Language	0 = Português 1 = English 2 = Español 3 = Français 4 = Downloaded		64h	03h	65h	USINT	201	enum	1
C6.3	Date and Time									
C6.3.1	Date and Time	yy/mm/dd and hh:mm:ss		64h	02h	C4h	SHORT_STRING	196	date	4
C6.3.2	Day of the Week	0 = Sunday 1 = Monday 2 = Tuesday 3 = Wednesday 4 = Thursday 5 = Friday 6 = Saturday		64h	02h	C3h	USINT	195	enum	1
C6.4	Main Screen									
C6.5	LCD Display									
C6.5.1	Backlight	1 to 15	0	64h	03h	76h	USINT	218	8bit	1
C6.5.2	Contrast	0 to 100 %	0	64h	03h	77h	USINT	219	8bit	1
C6.6	Communication Timeout									
C6.6.1	Mode	0 = Inactive 1 = Fault F127 2 = Alarm A127		64h	02h	BEh	USINT	190	enum	1
C6.6.2	Alarm Action	0 = Indicates Only 1 = Ramp Stop		64h	02h	BFh	USINT	191	enum	1

Parameter	Description	Range of values	Decimal places	Class	Instance	Attribute	CIP data type	Net Id	Size	Qty mapped words
C6.6.3	Time	2 = General Disable 3 = Change to LOC 4 = Change to REM 1 to 999 s	0	64h	02h	C0h	UINT	192	16bit	1
C7 Configurations\Special Functions										
C7.1	Forward/Reverse									
C7.1.1	Mode	0 = Inactive 1 = By Contactor 2 = Only for JOG		64h	03h	80h	USINT	228	enum	1
C7.2	Kick Start									
C7.2.1	Mode	0 = Off 1 = On		64h	06h	78h	USINT	520	enum	1
C7.2.2	Time	0.1 to 2.0 s	1	64h	06h	79h	USINT	521	8bit	1
C7.2.3	Voltage	70 to 90 %	0	64h	06h	7Ah	USINT	522	8bit	1
C7.2.4	Current	300 to 700 %	0	64h	06h	7Bh	UINT	523	16bit	1
C7.3	Jog									
C7.3.1	Mode	0 = Off 1 = On		64h	06h	6Eh	USINT	510	enum	1
C7.3.2	Level	10 to 100 %	0	64h	06h	6Fh	USINT	511	8bit	1
C7.4	Braking									
C7.4.1	Mode	0 = Inactive 1 = Reverse 2 = Optimal 3 = DC		64h	06h	64h	USINT	500	enum	1
C7.4.2	Time	1 to 299 s	0	64h	06h	65h	UINT	501	16bit	1
C7.4.3	Level	30 to 70 %	0	64h	06h	66h	USINT	502	8bit	1
C7.4.4	End	0 = Inactive 1 = Automatic		64h	06h	67h	USINT	503	enum	1
C8 Configurations\Communications										
C8.1	I/O Data									
C8.1.1	Data Read									
C8.1.1.1	Slot 1 1st Word	1 to 50	0	64h	08h	70h	USINT	712	8bit	1
C8.1.1.2	Slot 1 Quantity	1 to 50	0	64h	08h	71h	USINT	713	8bit	1
C8.1.1.3	Slot 2 1st Word	1 to 50	0	64h	08h	99h	USINT	753	8bit	1
C8.1.1.4	Slot 2 Quantity	1 to 50	0	64h	08h	9Ah	USINT	754	8bit	1
C8.1.1.5	Word #1	0 to 65535	0	64h	0Eh	64h	UINT	1300	16bit	1

Parameter	Description	Range of values	Decimal places	Class	Instance	Attribute	CIP data type	Net Id	Size	Qty mapped words
C8.1.1.6	Word #2	0 to 65535	0	64h	0Eh	65h	UINT	1301	16bit	1
C8.1.1.7	Word #3	0 to 65535	0	64h	0Eh	66h	UINT	1302	16bit	1
C8.1.1.8	Word #4	0 to 65535	0	64h	0Eh	67h	UINT	1303	16bit	1
C8.1.1.9	Word #5	0 to 65535	0	64h	0Eh	68h	UINT	1304	16bit	1
C8.1.1.10	Word #6	0 to 65535	0	64h	0Eh	69h	UINT	1305	16bit	1
C8.1.1.11	Word #7	0 to 65535	0	64h	0Eh	6Ah	UINT	1306	16bit	1
C8.1.1.12	Word #8	0 to 65535	0	64h	0Eh	6Bh	UINT	1307	16bit	1
C8.1.1.13	Word #9	0 to 65535	0	64h	0Eh	6Ch	UINT	1308	16bit	1
C8.1.1.14	Word #10	0 to 65535	0	64h	0Eh	6Dh	UINT	1309	16bit	1
C8.1.1.15	Word #11	0 to 65535	0	64h	0Eh	6Eh	UINT	1310	16bit	1
C8.1.1.16	Word #12	0 to 65535	0	64h	0Eh	6Fh	UINT	1311	16bit	1
C8.1.1.17	Word #13	0 to 65535	0	64h	0Eh	70h	UINT	1312	16bit	1
C8.1.1.18	Word #14	0 to 65535	0	64h	0Eh	71h	UINT	1313	16bit	1
C8.1.1.19	Word #15	0 to 65535	0	64h	0Eh	72h	UINT	1314	16bit	1
C8.1.1.20	Word #16	0 to 65535	0	64h	0Eh	73h	UINT	1315	16bit	1
C8.1.1.21	Word #17	0 to 65535	0	64h	0Eh	74h	UINT	1316	16bit	1
C8.1.1.22	Word #18	0 to 65535	0	64h	0Eh	75h	UINT	1317	16bit	1
C8.1.1.23	Word #19	0 to 65535	0	64h	0Eh	76h	UINT	1318	16bit	1
C8.1.1.24	Word #20	0 to 65535	0	64h	0Eh	77h	UINT	1319	16bit	1
C8.1.1.25	Word #21	0 to 65535	0	64h	0Eh	78h	UINT	1320	16bit	1
C8.1.1.26	Word #22	0 to 65535	0	64h	0Eh	79h	UINT	1321	16bit	1
C8.1.1.27	Word #23	0 to 65535	0	64h	0Eh	7Ah	UINT	1322	16bit	1
C8.1.1.28	Word #24	0 to 65535	0	64h	0Eh	7Bh	UINT	1323	16bit	1
C8.1.1.29	Word #25	0 to 65535	0	64h	0Eh	7Ch	UINT	1324	16bit	1
C8.1.1.30	Word #26	0 to 65535	0	64h	0Eh	7Dh	UINT	1325	16bit	1
C8.1.1.31	Word #27	0 to 65535	0	64h	0Eh	7Eh	UINT	1326	16bit	1
C8.1.1.32	Word #28	0 to 65535	0	64h	0Eh	7Fh	UINT	1327	16bit	1
C8.1.1.33	Word #29	0 to 65535	0	64h	0Eh	80h	UINT	1328	16bit	1
C8.1.1.34	Word #30	0 to 65535	0	64h	0Eh	81h	UINT	1329	16bit	1
C8.1.1.35	Word #31	0 to 65535	0	64h	0Eh	82h	UINT	1330	16bit	1
C8.1.1.36	Word #32	0 to 65535	0	64h	0Eh	83h	UINT	1331	16bit	1
C8.1.1.37	Word #33	0 to 65535	0	64h	0Eh	84h	UINT	1332	16bit	1
C8.1.1.38	Word #34	0 to 65535	0	64h	0Eh	85h	UINT	1333	16bit	1
C8.1.1.39	Word #35	0 to 65535	0	64h	0Eh	86h	UINT	1334	16bit	1
C8.1.1.40	Word #36	0 to 65535	0	64h	0Eh	87h	UINT	1335	16bit	1
C8.1.1.41	Word #37	0 to 65535	0	64h	0Eh	88h	UINT	1336	16bit	1
C8.1.1.42	Word #38	0 to 65535	0	64h	0Eh	89h	UINT	1337	16bit	1
C8.1.1.43	Word #39	0 to 65535	0	64h	0Eh	8Ah	UINT	1338	16bit	1
C8.1.1.44	Word #40	0 to 65535	0	64h	0Eh	8Bh	UINT	1339	16bit	1
C8.1.1.45	Word #41	0 to 65535	0	64h	0Eh	8Ch	UINT	1340	16bit	1
C8.1.1.46	Word #42	0 to 65535	0	64h	0Eh	8Dh	UINT	1341	16bit	1
C8.1.1.47	Word #43	0 to 65535	0	64h	0Eh	8Eh	UINT	1342	16bit	1

Parameter	Description	Range of values	Decimal places	Class	Instance	Attribute	CIP data type	Net Id	Size	Qty mapped words
C8.1.1.48	Word #44	0 to 65535	0	64h	0Eh	8Fh	UINT	1343	16bit	1
C8.1.1.49	Word #45	0 to 65535	0	64h	0Eh	90h	UINT	1344	16bit	1
C8.1.1.50	Word #46	0 to 65535	0	64h	0Eh	91h	UINT	1345	16bit	1
C8.1.1.51	Word #47	0 to 65535	0	64h	0Eh	92h	UINT	1346	16bit	1
C8.1.1.52	Word #48	0 to 65535	0	64h	0Eh	93h	UINT	1347	16bit	1
C8.1.1.53	Word #49	0 to 65535	0	64h	0Eh	94h	UINT	1348	16bit	1
C8.1.1.54	Word #50	0 to 65535	0	64h	0Eh	95h	UINT	1349	16bit	1
C8.1.2	Data Write									
C8.1.2.1	Slot 1 1st Word	1 to 20	0	64h	08h	72h	USINT	714	8bit	1
C8.1.2.2	Slot 1 Quantity	1 to 20	0	64h	08h	73h	USINT	715	8bit	1
C8.1.2.3	Slot 2 1st Word	1 to 20	0	64h	08h	9Bh	USINT	755	8bit	1
C8.1.2.4	Slot 2 Quantity	1 to 20	0	64h	08h	9Ch	USINT	756	8bit	1
C8.1.2.5	Update Delay	0.0 to 999.9 s	1	64h	09h	C7h	UINT	899	16bit	1
C8.1.2.6	Word #1	0 to 65535	0	64h	0Fh	64h	UINT	1400	16bit	1
C8.1.2.7	Word #2	0 to 65535	0	64h	0Fh	65h	UINT	1401	16bit	1
C8.1.2.8	Word #3	0 to 65535	0	64h	0Fh	66h	UINT	1402	16bit	1
C8.1.2.9	Word #4	0 to 65535	0	64h	0Fh	67h	UINT	1403	16bit	1
C8.1.2.10	Word #5	0 to 65535	0	64h	0Fh	68h	UINT	1404	16bit	1
C8.1.2.11	Word #6	0 to 65535	0	64h	0Fh	69h	UINT	1405	16bit	1
C8.1.2.12	Word #7	0 to 65535	0	64h	0Fh	6Ah	UINT	1406	16bit	1
C8.1.2.13	Word #8	0 to 65535	0	64h	0Fh	6Bh	UINT	1407	16bit	1
C8.1.2.14	Word #9	0 to 65535	0	64h	0Fh	6Ch	UINT	1408	16bit	1
C8.1.2.15	Word #10	0 to 65535	0	64h	0Fh	6Dh	UINT	1409	16bit	1
C8.1.2.16	Word #11	0 to 65535	0	64h	0Fh	6Eh	UINT	1410	16bit	1
C8.1.2.17	Word #12	0 to 65535	0	64h	0Fh	6Fh	UINT	1411	16bit	1
C8.1.2.18	Word #13	0 to 65535	0	64h	0Fh	70h	UINT	1412	16bit	1
C8.1.2.19	Word #14	0 to 65535	0	64h	0Fh	71h	UINT	1413	16bit	1
C8.1.2.20	Word #15	0 to 65535	0	64h	0Fh	72h	UINT	1414	16bit	1
C8.1.2.21	Word #16	0 to 65535	0	64h	0Fh	73h	UINT	1415	16bit	1
C8.1.2.22	Word #17	0 to 65535	0	64h	0Fh	74h	UINT	1416	16bit	1
C8.1.2.23	Word #18	0 to 65535	0	64h	0Fh	75h	UINT	1417	16bit	1
C8.1.2.24	Word #19	0 to 65535	0	64h	0Fh	76h	UINT	1418	16bit	1
C8.1.2.25	Word #20	0 to 65535	0	64h	0Fh	77h	UINT	1419	16bit	1
C8.2	RS485 Serial									
C8.2.1	Serial Protocol	0 ... 1 = Reserved 2 = Modbus RTU		64h	08h	82h	USINT	730	enum	1
C8.2.2	Address	1 to 247	0	64h	08h	83h	USINT	731	8bit	1
C8.2.3	Baud Rate	0 = 9600 bits/s 1 = 19200 bits/s		64h	08h	84h	USINT	732	enum	1

Parameter	Description	Range of values	Decimal places	Class	Instance	Attribute	CIP data type	Net Id	Size	Qty mapped words
C8.2.4	Bytes Config.	2 = 38400 bits/s 3 = 57600 bits/s 0 = 8 bits, no, 1 1 = 8 bits, even, 1 2 = 8 bits, odd, 1 3 = 8 bits, no, 2 4 = 8 bits, even, 2 5 = 8 bits, odd, 2		64h	08h	85h	USINT	733	enum	1
C8.2.5	Timeout									
C8.2.5.1	Mode	0 = Inactive 1 = Fault F128 2 = Alarm A128		64h	08h	8Ch	USINT	740	enum	1
C8.2.5.2	Alarm Action	0 = Indicates Only 1 = Ramp Stop 2 = General Disable 3 = Change to LOC 4 = Change to REM		64h	08h	8Dh	USINT	741	enum	1
C8.2.5.3	Timeout	0.0 to 999.9 s	1	64h	08h	86h	UINT	734	16bit	1
C8.3	Anybus-CC									
C8.3.1	Update Configuration	0 = Normal Operation 1 = Update configuration		64h	08h	95h	USINT	749	enum	1
C8.3.2	Address	0 to 255	0	64h	08h	9Dh	USINT	757	8bit	1
C8.3.3	Baud Rate	0 = 125 kbps 1 = 250 kbps 2 = 500 kbps 3 = Autobaud		64h	08h	9Eh	USINT	758	enum	1
C8.3.4	IP Address Configuration	0 = Parameters 1 = DHCP 2 = DCP		64h	08h	A0h	USINT	760	enum	1
C8.3.5	IP Address	0.0.0.0 to 255.255.255.255		64h	08h	A2h	UDINT	762	ip_address	2
C8.3.6	CIDR	0 = Reserved 1 = 128.0.0.0 2 = 192.0.0.0 3 = 224.0.0.0		64h	08h	A1h	USINT	761	enum	1

Parameter	Description	Range of values	Decimal places	Class	Instance	Attribute	CIP data type	Net Id	Size	Qty mapped words
		4 = 240.0.0.0 5 = 248.0.0.0 6 = 252.0.0.0 7 = 254.0.0.0 8 = 255.0.0.0 9 = 255.128.0.0 10 = 255.192.0.0 11 = 255.224.0.0 12 = 255.240.0.0 13 = 255.248.0.0 14 = 255.252.0.0 15 = 255.254.0.0 16 = 255.255.0.0 17 = 255.255.128.0 18 = 255.255.192.0 19 = 255.255.224.0 20 = 255.255.240.0 21 = 255.255.248.0 22 = 255.255.252.0 23 = 255.255.254.0 24 = 255.255.255.0 25 = 255.255.255.128 26 = 255.255.255.192 27 = 255.255.255.224 28 = 255.255.255.240 29 = 255.255.255.248 30 = 255.255.255.252 31 = 255.255.255.254								
C8.3.7	Gateway	0.0.0.0 to 255.255.255.255		64h	08h	A6h	UDINT	766	ip_address	2
C8.3.8	Station Name Suffix	0 to 254	0	64h	08h	AAh	USINT	770	8bit	1
C8.3.9	Modbus TCP Timeout									
C8.3.9.1	Mode	0 = Inactive 1 = Fault F131 2 = Alarm A131		64h	08h	ABh	USINT	771	enum	1
C8.3.9.2	Alarm Action	0 = Indicates Only 1 = Ramp Stop 2 = General Disable 3 = Change to LOC 4 = Change to REM		64h	08h	ACh	USINT	772	enum	1
C8.3.9.3	Modbus TCP Timeout	0.0 to 999.9 s	1	64h	08h	9Fh	UINT	759	16bit	1

Parameter	Description	Range of values	Decimal places	Class	Instance	Attribute	CIP data type	Net Id	Size	Qty mapped words
C8.3.10	Off Line Error									
C8.3.10.1	Mode	0 = Inactive 1 = Fault F129 2 = Alarm A129		64h	09h	C5h	USINT	897	enum	1
C8.3.10.2	Alarm Action	0 = Indicates Only 1 = Ramp Stop 2 = General Disable 3 = Change to LOC 4 = Change to REM		64h	09h	C6h	USINT	898	enum	1
C8.3.11	Web Server Config	0 = Disabled 1 = Enabled		64h	08h	C6h	USINT	798	enum	1
C8.4	CANopen/DeviceNet									
C8.4.1	Protocol	0 = Disabled 1 = CANopen 2 = DeviceNet		64h	08h	64h	USINT	700	enum	1
C8.4.2	Address	0 to 127	0	64h	08h	65h	USINT	701	8bit	1
C8.4.3	Baud Rate	0 = 1 Mbps/Auto 1 = Reserved 2 = 500 Kbps 3 = 250 Kbps 4 = 125 Kbps 5 = 100 Kbps/Auto 6 = 50 Kbps/Auto 7 = 20 Kbps/Auto 8 = 10 Kbps/Auto		64h	08h	66h	USINT	702	enum	1
C8.4.4	Bus Off Reset	0 = Manual 1 = Automatic		64h	08h	67h	USINT	703	enum	1
C8.4.5	CAN Error									
C8.4.5.1	Mode	0 = Inactive 1 = Fault 2 = Alarm		64h	08h	7Bh	USINT	723	enum	1
C8.4.5.2	Alarm Action	0 = Indicates Only 1 = Ramp Stop		64h	08h	7Ch	USINT	724	enum	1

Parameter	Description	Range of values	Decimal places	Class	Instance	Attribute	CIP data type	Net Id	Size	Qty mapped words
		2 = General Disable 3 = Change to LOC 4 = Change to REM								
C8.5	Ethernet									
C8.5.1	IP Address Config	0 = Parameters 1 = DHCP		64h	09h	96h	USINT	850	enum	1
C8.5.2	IP Address	0.0.0.0 to 255.255.255.255		64h	09h	98h	UDINT	852	ip_address	2
C8.5.3	CIDR Sub-net	0 = Reserved 1 = 128.0.0.0 2 = 192.0.0.0 3 = 224.0.0.0 4 = 240.0.0.0 5 = 248.0.0.0 6 = 252.0.0.0 7 = 254.0.0.0 8 = 255.0.0.0 9 = 255.128.0.0 10 = 255.192.0.0 11 = 255.224.0.0 12 = 255.240.0.0 13 = 255.248.0.0 14 = 255.252.0.0 15 = 255.254.0.0 16 = 255.255.0.0 17 = 255.255.128.0 18 = 255.255.192.0 19 = 255.255.224.0 20 = 255.255.240.0 21 = 255.255.248.0 22 = 255.255.252.0 23 = 255.255.254.0 24 = 255.255.255.0 25 = 255.255.255.128 26 = 255.255.255.192 27 = 255.255.255.224 28 = 255.255.255.240 29 = 255.255.255.248 30 = 255.255.255.252 31 = 255.255.255.254		64h	09h	9Bh	USINT	855	enum	1
C8.5.4	Gateway	0.0.0.0 to 255.255.255.255		64h	09h	9Ch	UDINT	856	ip_address	2

Parameter	Description	Range of values	Decimal places	Class	Instance	Attribute	CIP data type	Net Id	Size	Qty mapped words
C8.5.5	MBTCP: TCP Port	0 to 65535	0	64h	09h	A5h	UINT	865	16bit	1
C8.5.7	EIP Data Profile	0 ... 9 = Reserved 10 = 110/160-Configurable I/O		64h	09h	ABh	USINT	871	enum	1
C8.5.9	Modbus TCP Error									
C8.5.9.1	Mode	0 = Inactive 1 = Fault F149 2 = Alarm A149		64h	09h	C1h	USINT	893	enum	1
C8.5.9.2	Alarm Action	0 = Indicates Only 1 = Ramp Stop 2 = General Disable 3 = Change to LOC 4 = Change to REM		64h	09h	C2h	USINT	894	enum	1
C8.5.9.3	Timeout	0.0 to 999.9 s	1	64h	09h	A8h	UINT	868	16bit	1
C8.5.10	EtherNet/IP Error									
C8.5.10.1	Mode	0 = Inactive 1 = Fault F147 2 = Alarm A147		64h	09h	C3h	USINT	895	enum	1
C8.5.10.2	Alarm Action	0 = Indicates Only 1 = Ramp Stop 2 = General Disable 3 = Change to LOC 4 = Change to REM		64h	09h	C4h	USINT	896	enum	1
C8.5.11	Web Server Config	0 = Disabled 1 = Enabled		64h	08h	C6h	USINT	798	enum	1
C8.6	Bluetooth									
C8.6.1	Mode	0 = Off 1 = On		64h	09h	64h	USINT	800	enum	1
C9 Configurations\SSW900										
C9.1	Nominal Data									
C9.1.1	Current	0 = 10 A 1 = 17 A 2 = 24 A 3 = 30 A		64h	03h	C3h	USINT	295	enum	1

Parameter	Description	Range of values	Decimal places	Class	Instance	Attribute	CIP data type	Net Id	Size	Qty mapped words
		4 = 45 A 5 = 61 A 6 = 85 A 7 = 105 A 8 = 130 A 9 = 171 A 10 = 200 A 11 = 255 A 12 = 312 A 13 = 365 A 14 = 412 A 15 = 480 A 16 = 604 A 17 = 670 A 18 = 820 A 19 = 950 A 20 = 1100 A 21 = 1400 A								
C9.2	Types of Connections									
C9.2.1	Delta Inside	0 = Off 1 = On		64h	02h	96h	USINT	150	enum	1
C9.2.2	External Bypass	0 = Without 1 = With		64h	02h	8Ch	USINT	140	enum	1
C9.3	Accessories Config.									
C9.3.1	Slot 1	0 = Automatic 1 = Anybus-CC 2 = RS-485 3 = PT100 4 = I/Os Exp. 5 = Profibus 6 = CAN 7 = Ethernet 8 = External Current Acqu.		64h	04h	89h	USINT	337	enum	1
C9.3.2	Slot 2	0 = Automatic 1 = Anybus-CC 2 = RS-485 3 = PT100		64h	04h	8Ah	USINT	338	enum	1

Parameter	Description	Range of values	Decimal places	Class	Instance	Attribute	CIP data type	Net Id	Size	Qty mapped words
		4 = I/Os Exp. 5 = Profibus 6 = CAN 7 = Ethernet 8 = External Current Acqu.								
C9.4	Fan Configuration									
C9.4.1	Mode	0 = Always Off 1 = Always On 2 = Controlled		64h	03h	67h	USINT	203	enum	1
C10 Configurations\Load / Save Parameters										
C10.1	Load / Save User									
C10.1.1	Mode	0 = Not Used 1 = Load User 1 2 = Load User 2 3 = Reserved 4 = Save User 1 5 = Save User 2 6 = Reserved		64h	03h	6Ah	USINT	206	enum	1
C10.2	Copy Function HMI									
C10.2.1	Mode	0 = Off 1 = SSW -> HMI 2 = HMI -> SSW		64h	04h	77h	USINT	319	enum	1
C10.3	Erase Diagnostics									
C10.3.1	Mode	0 ... 1 = Not Used 2 = Fault 3 = Alarms 4 = Events 5 = Motor ON 6 = Temperaturas 7 = Hours Control 8 = Thermal Class Status		64h	03h	69h	USINT	205	enum	1
C10.4	Load Factory Default									
C10.4.1	Mode	0 = No 1 = Yes		64h	03h	68h	USINT	204	enum	1
C10.5	Save Changed Param.									
C10.5.1	Mode			64h	03h	6Dh	USINT	209	enum	1

Parameter	Description	Range of values	Decimal places	Class	Instance	Attribute	CIP data type	Net Id	Size	Qty mapped words
		0 = No 1 = Yes								
C11 Configurations\SoftPLC										
C11.1	Mode	0 = Stop Program 1 = Run Program		64h	0Ch	65h	USINT	1101	enum	1
C11.2	Action App. Not Running	0 = Inactive 1 = Alarm A708 2 = Fault F708		64h	0Ch	67h	USINT	1103	enum	1
C11.3	Parameter									
C11.3.1	User #1	-10000 to 10000	0	64h	0Ch	6Eh	DINT	1110	s32bit	2
C11.3.2	User #2	-10000 to 10000	0	64h	0Ch	70h	DINT	1112	s32bit	2
C11.3.3	User #3	-10000 to 10000	0	64h	0Ch	72h	DINT	1114	s32bit	2
C11.3.4	User #4	-10000 to 10000	0	64h	0Ch	74h	DINT	1116	s32bit	2
C11.3.5	User #5	-10000 to 10000	0	64h	0Ch	76h	DINT	1118	s32bit	2
C11.3.6	User #6	-10000 to 10000	0	64h	0Ch	78h	DINT	1120	s32bit	2
C11.3.7	User #7	-10000 to 10000	0	64h	0Ch	7Ah	DINT	1122	s32bit	2
C11.3.8	User #8	-10000 to 10000	0	64h	0Ch	7Ch	DINT	1124	s32bit	2
C11.3.9	User #9	-10000 to 10000	0	64h	0Ch	7Eh	DINT	1126	s32bit	2
C11.3.10	User #10	-10000 to 10000	0	64h	0Ch	80h	DINT	1128	s32bit	2
C11.3.11	User #11	-10000 to 10000	0	64h	0Ch	82h	DINT	1130	s32bit	2
C11.3.12	User #12	-10000 to 10000	0	64h	0Ch	84h	DINT	1132	s32bit	2
C11.3.13	User #13	-10000 to 10000	0	64h	0Ch	86h	DINT	1134	s32bit	2
C11.3.14	User #14	-10000 to 10000	0	64h	0Ch	88h	DINT	1136	s32bit	2
C11.3.15	User #15	-10000 to 10000	0	64h	0Ch	8Ah	DINT	1138	s32bit	2
C11.3.16	User #16	-10000 to 10000	0	64h	0Ch	8Ch	DINT	1140	s32bit	2
C11.3.17	User #17	-10000 to 10000	0	64h	0Ch	8Eh	DINT	1142	s32bit	2
C11.3.18	User #18	-10000 to 10000	0	64h	0Ch	90h	DINT	1144	s32bit	2
C11.3.19	User #19	-10000 to 10000	0	64h	0Ch	92h	DINT	1146	s32bit	2
C11.3.20	User #20	-10000 to 10000	0	64h	0Ch	94h	DINT	1148	s32bit	2
C11.3.21	User #21	-10000 to 10000	0	64h	0Ch	96h	DINT	1150	s32bit	2
C11.3.22	User #22	-10000 to 10000	0	64h	0Ch	98h	DINT	1152	s32bit	2
C11.3.23	User #23	-10000 to 10000	0	64h	0Ch	9Ah	DINT	1154	s32bit	2
C11.3.24	User #24	-10000 to 10000	0	64h	0Ch	9Ch	DINT	1156	s32bit	2
C11.3.25	User #25	-10000 to 10000	0	64h	0Ch	9Eh	DINT	1158	s32bit	2
C11.3.26	User #26	-10000 to 10000	0	64h	0Ch	A0h	DINT	1160	s32bit	2
C11.3.27	User #27	-10000 to 10000	0	64h	0Ch	A2h	DINT	1162	s32bit	2
C11.3.28	User #28	-10000 to 10000	0	64h	0Ch	A4h	DINT	1164	s32bit	2
C11.3.29	User #29	-10000 to 10000	0	64h	0Ch	A6h	DINT	1166	s32bit	2
C11.3.30	User #30	-10000 to 10000	0	64h	0Ch	A8h	DINT	1168	s32bit	2

Parameter	Description	Range of values	Decimal places	Class	Instance	Attribute	CIP data type	Net Id	Size	Qty mapped words
C11.3.31	User #31	-10000 to 10000	0	64h	0Ch	AAh	DINT	1170	s32bit	2
C11.3.32	User #32	-10000 to 10000	0	64h	0Ch	ACh	DINT	1172	s32bit	2
C11.3.33	User #33	-10000 to 10000	0	64h	0Ch	A Eh	DINT	1174	s32bit	2
C11.3.34	User #34	-10000 to 10000	0	64h	0Ch	B0h	DINT	1176	s32bit	2
C11.3.35	User #35	-10000 to 10000	0	64h	0Ch	B2h	DINT	1178	s32bit	2
C11.3.36	User #36	-10000 to 10000	0	64h	0Ch	B4h	DINT	1180	s32bit	2
C11.3.37	User #37	-10000 to 10000	0	64h	0Ch	B6h	DINT	1182	s32bit	2
C11.3.38	User #38	-10000 to 10000	0	64h	0Ch	B8h	DINT	1184	s32bit	2
C11.3.39	User #39	-10000 to 10000	0	64h	0Ch	BAh	DINT	1186	s32bit	2
C11.3.40	User #40	-10000 to 10000	0	64h	0Ch	BCh	DINT	1188	s32bit	2
C11.3.41	User #41	-10000 to 10000	0	64h	0Ch	BEh	DINT	1190	s32bit	2
C11.3.42	User #42	-10000 to 10000	0	64h	0Ch	C0h	DINT	1192	s32bit	2
C11.3.43	User #43	-10000 to 10000	0	64h	0Ch	C2h	DINT	1194	s32bit	2
C11.3.44	User #44	-10000 to 10000	0	64h	0Ch	C4h	DINT	1196	s32bit	2
C11.3.45	User #45	-10000 to 10000	0	64h	0Ch	C6h	DINT	1198	s32bit	2
C11.3.46	User #46	-10000 to 10000	0	64h	0Dh	64h	DINT	1200	s32bit	2
C11.3.47	User #47	-10000 to 10000	0	64h	0Dh	66h	DINT	1202	s32bit	2
C11.3.48	User #48	-10000 to 10000	0	64h	0Dh	68h	DINT	1204	s32bit	2
C11.3.49	User #49	-10000 to 10000	0	64h	0Dh	6Ah	DINT	1206	s32bit	2
C11.3.50	User #50	-10000 to 10000	0	64h	0Dh	6Ch	DINT	1208	s32bit	2
C11.4	SoftPLC Application	0 = User 1 = Timer Control 2 = Pump Cleaning		64h	0Ch	68h	USINT	1104	enum	1
A1 Assistant\Oriented Start-up										
A1.1	Mode	0 = No 1 = Yes		64h	04h	75h	USINT	317	enum	1

QUICK REFERENCES

Table 9.3: Description of the parameter data types

Data Type	Description
enum	Enumerated type (unsigned 8-bit) contains a list of values with function description for each item.
8bit	Unsigned 8-bit integer, ranges from 0 to 255.
16bit	Unsigned 16-bit integer, ranges from 0 to 65,535.
s16bit	Signed 16-bit integer, ranges from -32,768 to 32,767.
32bit	Unsigned 32-bit integer, ranges from 0 to 4,294,967,295.
s32bit	Signed 32-bit integer, ranges from -2,147,483,648 to 2,147,483,647.
date	Displays the date and time value in the format below: second (1 byte) minute (1 byte) hour (1 byte) day (1 byte) month (1 byte) reserved (1 byte) year (2 bytes)
TIME	Displays the time in the format hh:mm:ss. For network protocols, this data type is transferred as an unsigned 32-bit integer value representing the number of seconds.
ip_address	Unsigned 32-bit integer representing the octets of the IP address.
MAC_ADDRESS	48-bit identifier displayed in XX:XX:XX:XX:XX:XX format.
STRING_ASCII	Text string. For network protocols, this data type is transferred as a string filled with zeros (0) to the end (maximum parameter size plus one).



BRAZIL

WEG DRIVES & CONTROLS - AUTOMAÇÃO LTDA.

Av. Prefeito Waldemar Grubba, 3000

89256-900 - Jaraguá do Sul - SC

Phone: 55 (47) 3276-4000

Fax: 55 (47) 3276-4060

www.weg.net/br