

CPTW Series

Control Power Transformers

Compact and Economical Solutions



www.weg.net | 1-800-ASK-4WEG

VOLTAGE TABLE

VA	Primary Voltage	Secondary Voltage	Part Number
1000	220 x 440, 230 x 460, 240 x 480	110, 115, 120	CPTW1K0-ASC
Max Depth	Max Width	Max Height	Mounting Depth
6.61"	7.00"	5.65"	4.00"
Mounting Width	Mounting Hole Depth	Mounting Hole Width	Phase
6.13"	0.31"	1.06"	1
Frequency	Shipping Weight	Voltage Group	
50/60 Hz	29.8 lbs.	A	

0.0K

▽ R {] ^ / S a \ a a 0 • ^ A j a @ a @ A [o a & ~ a ^ a
 ▽ O a a A B I + A A @ A O ^] c O C D A @ } A • ^ A j a • A e ^ A a & ~ a ^ a A C E A @ A I E X O D
 ▽ O a a A B I + A A @ A P a @ A O D A @ } A • ^ A j a [& A A a & ~ a ^ a A F E C A a A A [I • D C E A @ A I E X O D
 ▽ O a a A B I + A A @ A P a @ A O D A @ } A • ^ A j a [& A A a & ~ a ^ a A F E C A a A A [I • D C E A @ A I E X O D

DIAGRAM

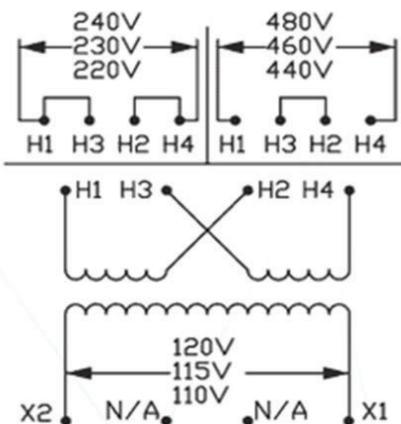

SPECIFICATIONS

- Class 180°C (356°F) insulation system with 115°C (239°F) temperature rise.
- All transformers up to 750VA come with pre-installed secondary fuse kits, ready to accept 13/32" x 1 1/2" midget or Class CC fuses.
- Two parallel jumper links come standard with transformers with dual primary voltages.
- All transformers up to 3kVA include a built-in mounting adapter for fuse blocks.