



GARANTIA / WARRANTY / GARANTÍA / GEWÄHRLEISTUNG:

A WEG oferece garantia limitada contra defeitos de fabricação ou de materiais de seus produtos. Para mais informações acesse nosso site:

WEG provides a limited warranty for its products against defects in materials and workmanship. For more information access our site:

WEG ofrece garantía limitada contra defectos de fabricación o de materiales de sus productos. Para más informaciones acceda al WEB sitio:

WEG bietet eine beschränkte Gewährleistung für ihre Produkte gegen Herstellungs- und Materialfehler. Für weitere Informationen besuchen Sie bitte unsere Webseite:

www.weg.net/warranty-automation

WEG IMPORTERS IN THE EUROPEAN UNION

AUSTRIA - WATT DRIVE ANTRIEBSTECHNIK GMBH - Wöllersdorfer Str. 68, 2753 Markt Piesting, Wiener, Austria; **BELGIUM** - WEG BENELUX S.A. - Rue de l'Industrie 30/D, 1400 Nivelles, Belgium; **FRANCE** - WEG FRANCE SAS - 13 Rue du Moreillon, 38297 Saint Quentin Fallavier, France; **GERMANY** - WEG GERMANY GMBH - Geigerstraße 7, 50169 Industriegebiet Türrich 3, Kerpen, Germany; **ITALY** - WEG ITALIA S.R.L. - Via Viganò de Vizzi, 93/95, 20092 Cinisello Balsamo, Milano, Italy; **NETHERLANDS** - WEG NETHERLANDS - Hanzepoort 23C, 7575 DB Oldenzaal, Netherlands; **PORTUGAL** - WEG EURO-INDUSTRIA ELECTRICA S.A. - R. Eng. Frederico Ulrich 605, 4471-908 Maia, Portugal; **SPAIN** - WEG IBERIA INDUSTRIAL S.L. - C/ Tierra de Barros, 5-7, 28823 Coslada, Madrid, Spain; **SCANDINAVIA** - WEG SCANDINAVIA AB - Box 27, 435 21, 43533 Mölnlycke, Sweden; **UNITED KINGDOM** - WEG (UK) LTD - Broad Ground Road, Redditch B988YP, Worcestershire, United Kingdom.

Information valid for WEG Group Importers.

ATENÇÃO:

-Desconecte da rede elétrica antes de proceder qualquer trabalho neste equipamento.

-Somente profissionais qualificados podem efetuar a instalação e manutenção.

-Obedecer normas nacionais, estaduais, locais e instruções de operação.

WARNING:

-Installation and maintenance to be performed by authorized personnel only.

-User is cautioned to observe all recommendations, warnings and cautions relating to safety of personnel and equipment as well as general and local health and safety laws, codes and procedures.

ATENCIÓN:

- Desconectar de la red eléctrica antes de hacer cualquier trabajo en este equipamiento.

- Recomendase instalación por profesional calificado.

- Respetar normas nacionales y locales.

- Producto destinado a utilización en instalaciones eléctricas de baja tensión.

WARNING:

- Bevor irgend eine Arbeit am Gerät vorgenommen wird, muss sichergestellt sein, dass die Einheit stromlos und freigeschaltet ist.

- Sämtliche Arbeiten an der Einheit dürfen daher ausschließlich nur von Fachpersonal vorgenommen werden.

- Die jeweils geltenden nationalen, örtlichen und anlagenspezifischen Bestimmungen und Erfordernisse sind zu berücksichtigen.

DANGER

RISK OF ELECTRIC SHOCK,
BURN OR EXPLOSION



1) TURN OFF AND LOCK OUT ALL POWER SUPPLYING THIS EQUIPMENT BEFORE WORKING ON OR INSIDE EQUIPMENT.

2) REPLACE ALL DEVICES, DOORS, AND COVERS BEFORE TURNING ON POWER TO THIS EQUIPMENT.

3) ALWAYS VERIFY THAT NO VOLTAGE IS PRESENT BEFORE WORKING ON OR INSIDE EQUIPMENT, AND ALWAYS FOLLOW GENERALLY ACCEPTED SAFETY PROCEDURES.

FAILURE TO FOLLOW THESE INSTRUCTIONS WILL RESULT IN DEATH OR SEVERE INJURY.

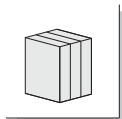

**DWB600 3P
DWB800 3P
DWB1000 3P**

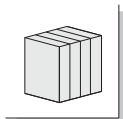
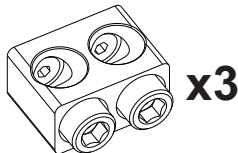

**DWB800 4P
DWB1000 4P**

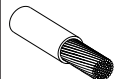
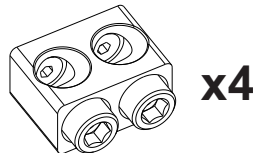

**DWB600
DWB800
DWB1000**

UL connector
temperature - 75 °C
Cooper wire
325...600 A
3/0 AWG ... 400 kcmil

28 mm

1.1"

320...800 A
95...240 mm²



Allen #5
20 N.m - 177 lb.in

Allen #10
55 N.m - 487 lb.in

UL	CE
DWB600 - 3P	DWB800 - 3P / 4P DWB1000 - 3P / 4P

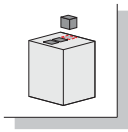
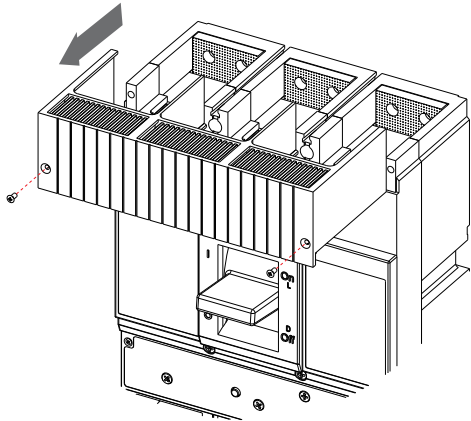
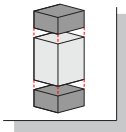

Allen #5
20 N.m - 177 lb.in

Allen #10
55 N.m - 487 lb.in

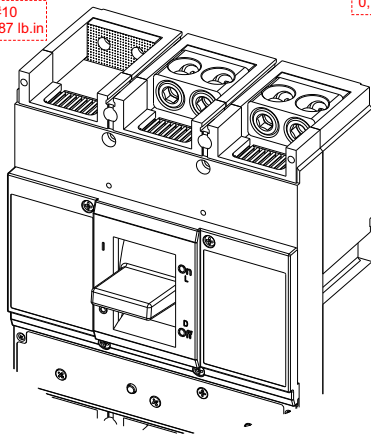
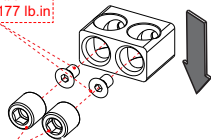

Phillips #1
0,7 N.m - 6,2 lb.in

