

# TOMADAS & INTERRUPTORES LINHA EQUILLE



equille

Motores | Automação | Energia | Transmissão & Distribuição | Tintas





Forma e função em pleno  
**equilíbrio.**

# equille



Com um design prático, a linha de Tomadas & Interruptores **Equille** traz funcionalidade e agilidade para o seu projeto.

O nome traz o conceito de equilíbrio, valorizando as linhas retas associadas aos cantos com arredondamentos suaves. Esses detalhes associados ao formato slim, compõem um design com pleno equilíbrio entre forma e função.

# Acabamentos

## A sutileza está nos detalhes

Os melhores projetos sempre prezam pela simplicidade e trazem pequenos detalhes que se tornam diferenciais importantes para o usuário, como os traços da linha **Equille**, que combinam com todos os tipos de ambientes.



- Superfície polida
- Proteção UV contra amarelamento
- Cantos arredondados
- Placa slim
- Ângulos que trazem suavidade e leveza ao conjunto



# Modularidade

## O módulo ideal para sua necessidade

Os conjuntos da linha **Equille** são formados por placa e módulos, unindo a flexibilidade de uma linha modular com a praticidade do suporte integrado. Assim, você desfruta da linha completa de módulos e ganha velocidade na instalação.

### Facilidade na instalação:

- Suporte integrado
- Facilidade na colocação e retirada dos módulos
- Velocidade na instalação



# Conectividade









Mantendo o equilíbrio entre simplicidade e tecnologia, além de todos os módulos essenciais para sua instalação, na linha Equille você também encontra o módulo carregador USB com corrente de saída de 2 A, capaz de carregar seus dispositivos móveis.



# Módulos

	Descrição	Cor	Embalagem (peças)	Código
	Interruptor simples 10 A - 250 V~ 1 módulo	Branco	50	14232335
	Interruptor paralelo 10 A - 250 V~ 1 módulo	Branco	50	14232337
	Pulsador p/ campainha 10 A 250 V~ 1 módulo	Branco	20	14232359
	Pulsador universal s/ gravação 10 A - 250 V~ 1 módulo	Branco	20	14232362
	Tomada 2P+T 10 A 250 V~ 1 módulo	Branco	50	14232388
	Tomada 2P+T 20 A 250 V~ 1 módulo	Branco	50	14232395
	Tomada 2P+T 10 A 250 V~ vermelha para identificação de circuitos - 1 módulo	Vermelha	20	14232429
	Tomada 2P+T 20 A 250 V~ vermelha para identificação de circuitos - 1 módulo	Vermelha	20	14232434
	Tomada com 1 RJ11 4 fios 1 módulo	Branco	20	14235630
	Tomada RJ45 com Keystone CAT 5E 1 módulo	Branco	20	14235633
	Tomada para antena de TV Terminal coaxial 75 Ω 1 módulo	Branco	20	14235635
	Campainha Cigarra Bivolt 127/220 V ca 1 módulo	Branco	20	14232329
	Carregador USB Bivolt 127/220 V ca 1 módulo	Branco	20	14232332
	Módulo cego (2 unidades por emb.) 1 módulo	Branco	20	14232262
	Módulo saída de fio (2 unidades por emb.) 1 módulo	Branco	20	14232266
	Módulo para conector RJ45 (2 unidades por emb.) 1 módulo	Branco	20	14232301

# Placas

Descrição	Cor	Embalagem (peças)	Código
 <p>Placa 4x2" cega</p>	Branco	25	14232450
 <p>Placa 4x2" cega</p>	Cinza	25	14232451
 <p>Placa 4x2" 1 posição</p>	Branco	25	14232454
 <p>Placa 4x2" 1 posição</p>	Cinza	25	14232457
 <p>Placa 4x2" 2 posições</p>	Branco	25	14232534
 <p>Placa 4x2" 2 posições</p>	Cinza	25	14232571
 <p>Placa 4x2" 3 posições</p>	Branco	25	14232572
 <p>Placa 4x2" 3 posições</p>	Cinza	25	14232574



# Placas

Descrição	Cor	Embalagem (peças)	Código
 Placa 4x4" cega	Branco	20	14232575
 Placa 4x4" cega	Cinza	20	14234203
 Placa 4x4" 6 posições	Branco	20	14234204
 Placa 4x4" 6 posições	Cinza	20	14234205







**Placas** nas cores branco e cinza

# Conjuntos Montados

Descrição	Cor	Embalagem (peças)	Código
 1 interruptor simples 10 A - 250 V~ + placa 4x2" com suporte integrado	Branco	15	14234206
 1 interruptor paralelo 10 A - 250 V~ + placa 4x2" com suporte integrado	Branco	15	14234207
 2 interruptores simples 10 A - 250 V~ + placa 4x2" com suporte integrado	Branco	15	14234278
 2 interruptores paralelos 10 A - 250 V~ + placa 4x2" com suporte integrado	Branco	15	14234279
 1 interruptor simples + 1 interruptor paralelo 10 A - 250 V~ + placa 4x2" com suporte integrado	Branco	15	14234280
 3 interruptores simples 10 A - 250 V~ + placa 4x2" com suporte integrado	Branco	15	14234281
 1 interruptor simples + 1 tomada 2P+T 10 A - 250 V~ + placa 4x2" com suporte integrado	Branco	15	14235637
 1 interruptor paralelo + 1 tomada 2P+T 10 A - 250 V~ + placa 4x2" com suporte integrado"	Branco	15	14235688
 1 interruptor simples + 1 tomada 2P+T 20 A - 250 V~ + placa 4x2" com suporte integrado	Branco	15	14235691
 2 interruptores simples + 1 tomada 2P+T 10 A - 250 V~ + placa 4x2" com suporte integrado	Branco	15	14235689
 1 tomada 2P+T 10 A - 250 V~ + placa 4x2" com suporte integrado	Branco	15	14237021
 1 tomada 2P+T 20 A - 250 V~ + placa 4x2" com suporte integrado	Branco	15	14237023
 2 tomadas 2P+T 10 A - 250 V~ + placa 4x2" com suporte integrado	Branco	15	14237022
 2 tomadas 2P+T 20 A - 250 V~ + placa 4x2" com suporte integrado	Branco	15	14237024

# Conjuntos Montados

Descrição	Cor	Embalagem (peças)	Código
 1 tomada RJ11 + placa 4x2" com suporte integrado	Branco	15	14237128
 1 tomada para antena de TV terminal coaxial 75 Ω + placa 4x2" com suporte integrado	Branco	15	14237129
 1 pulsador para campainha 10 A - 250 V~ + placa 4x2" com suporte integrado	Branco	15	14235697
 1 cigarra bivolt (127/220 V ca) + placa 4x2" com suporte integrado	Branco	15	14236078
 1 módulo saída de fio + Placa 4x2" com suporte integrado	Branco	15	14606478

## Sistema de Encaixe e Retirada dos Módulos

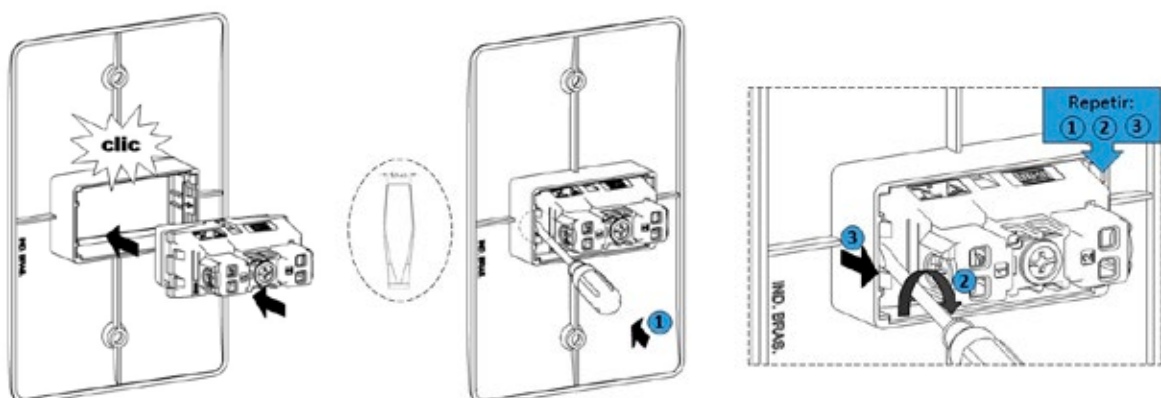

# Dimensões (mm)

## Interruptores

### Interruptor Simples e Paralelo

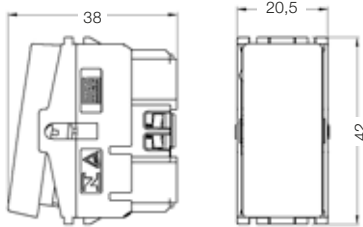

## Pulsadores

### Pulsador Campanha

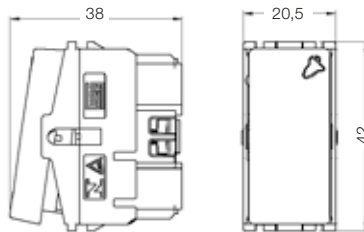

### Pulsador Universal

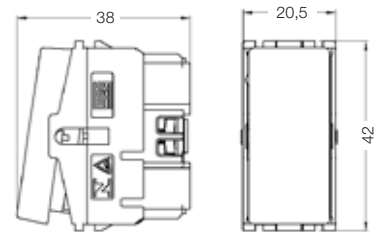

## Tomadas

### Tomada 2P+T 10 A

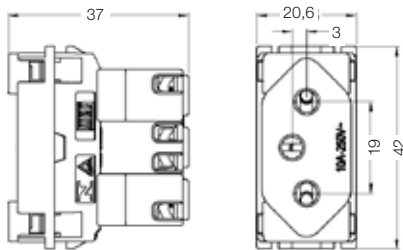

### Tomada 2P+T 20 A

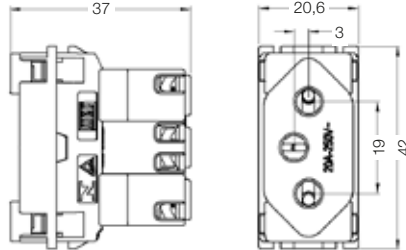

## Campainha

### Módulo Cigarra

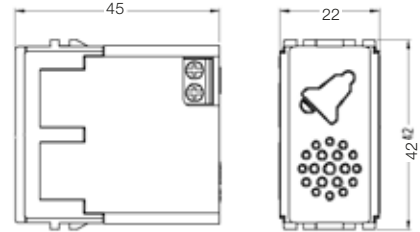

## Comunicação

### Módulo Antena

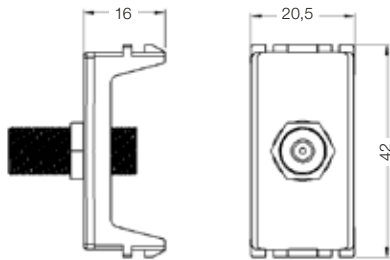

### Módulo RJ11

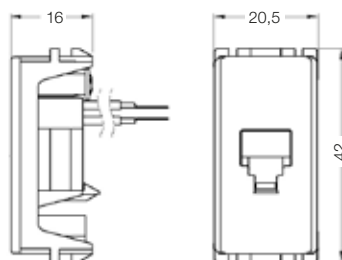

### Módulo RJ45

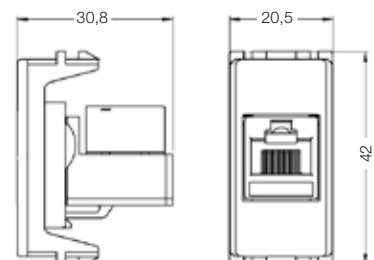

## Eletrônicos

### Módulo Carregador USB

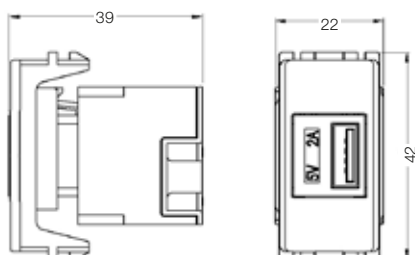

## Módulos Complementares

### Módulo Cego

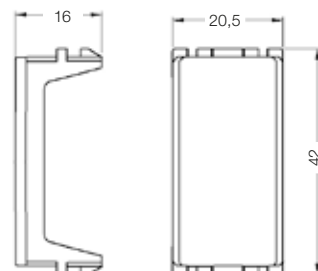

### Módulo Saída de Fio

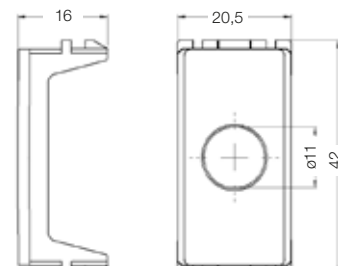

# Dimensões (mm)

## Placas

**Placa 4x2 - 1 Posição**

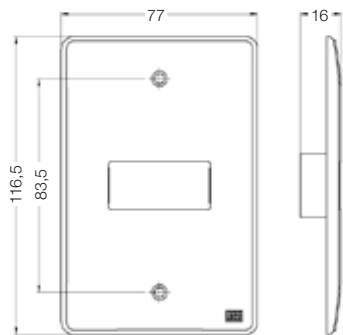

**Placa 4x2 - 2 Posições**

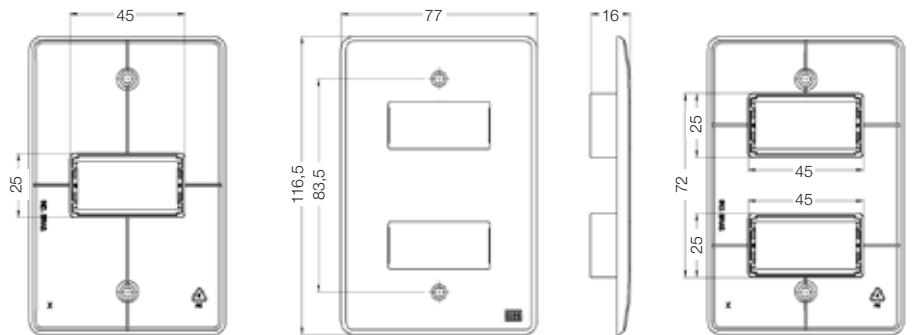

**Placa 4x2 - 3 Posições**

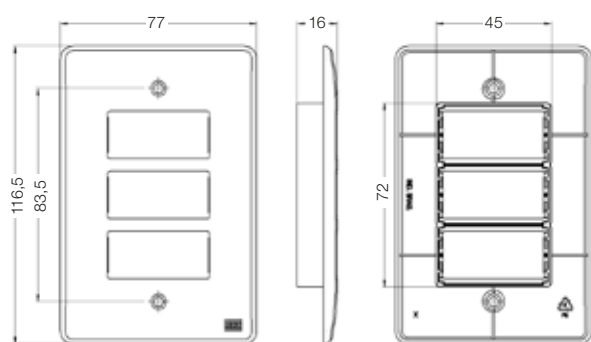

**Placa 4x2 - Cega**

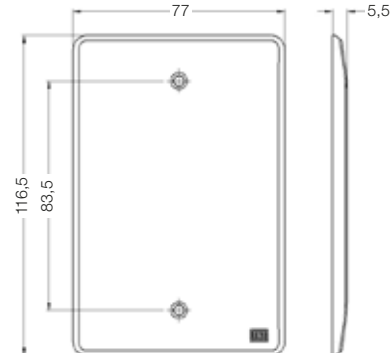

**Placa 4x4 - Cega**

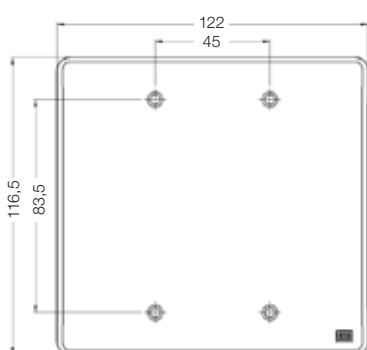

**Placa 4x4 - 6 Posições**

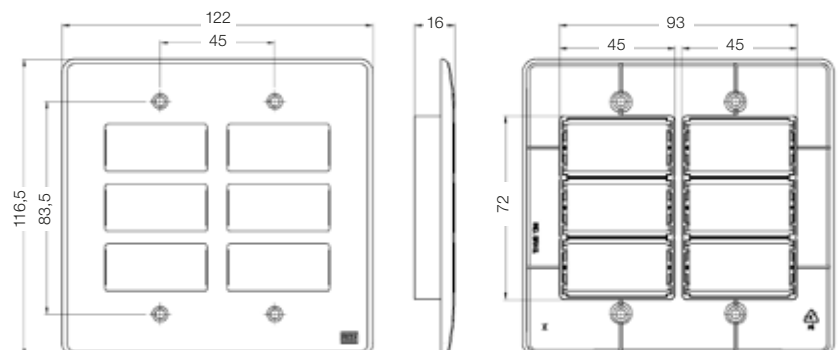

# Presença global é essencial. Entender o que você precisa também.

## Presença Global

Com mais de 30.000 colaboradores por todo o mundo, somos um dos maiores produtores mundiais de motores elétricos, equipamentos e sistemas eletroeletrônicos. Estamos constantemente expandindo nosso portfólio de produtos e serviços com conhecimento especializado e de mercado. Criamos soluções integradas e customizadas que abrangem desde produtos inovadores até assistência pós-venda completa.

Com o *know-how* da WEG, as **Tomadas e Interruptores Equille** são a escolha certa para sua aplicação e seu negócio, com segurança, proteção e confiabilidade.



**Disponibilidade** é possuir uma rede global de serviços



**Parceria** é criar soluções que atendam suas necessidades



**Competitividade** é unir tecnologia e inovação

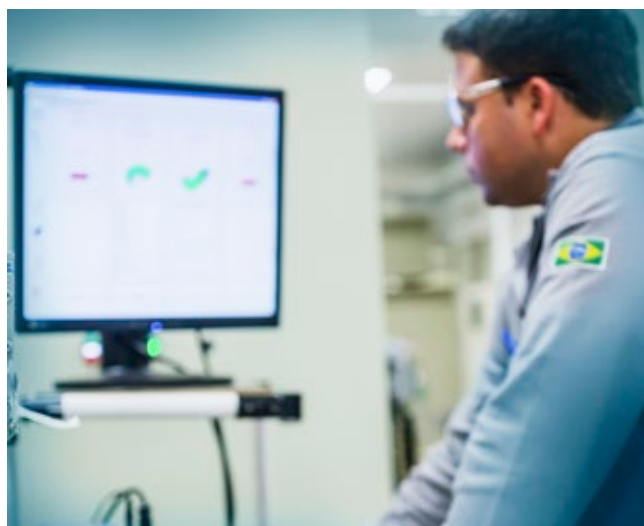

# Conheça



Produtos de alto desempenho e confiabilidade,  
para melhorar o seu processo produtivo

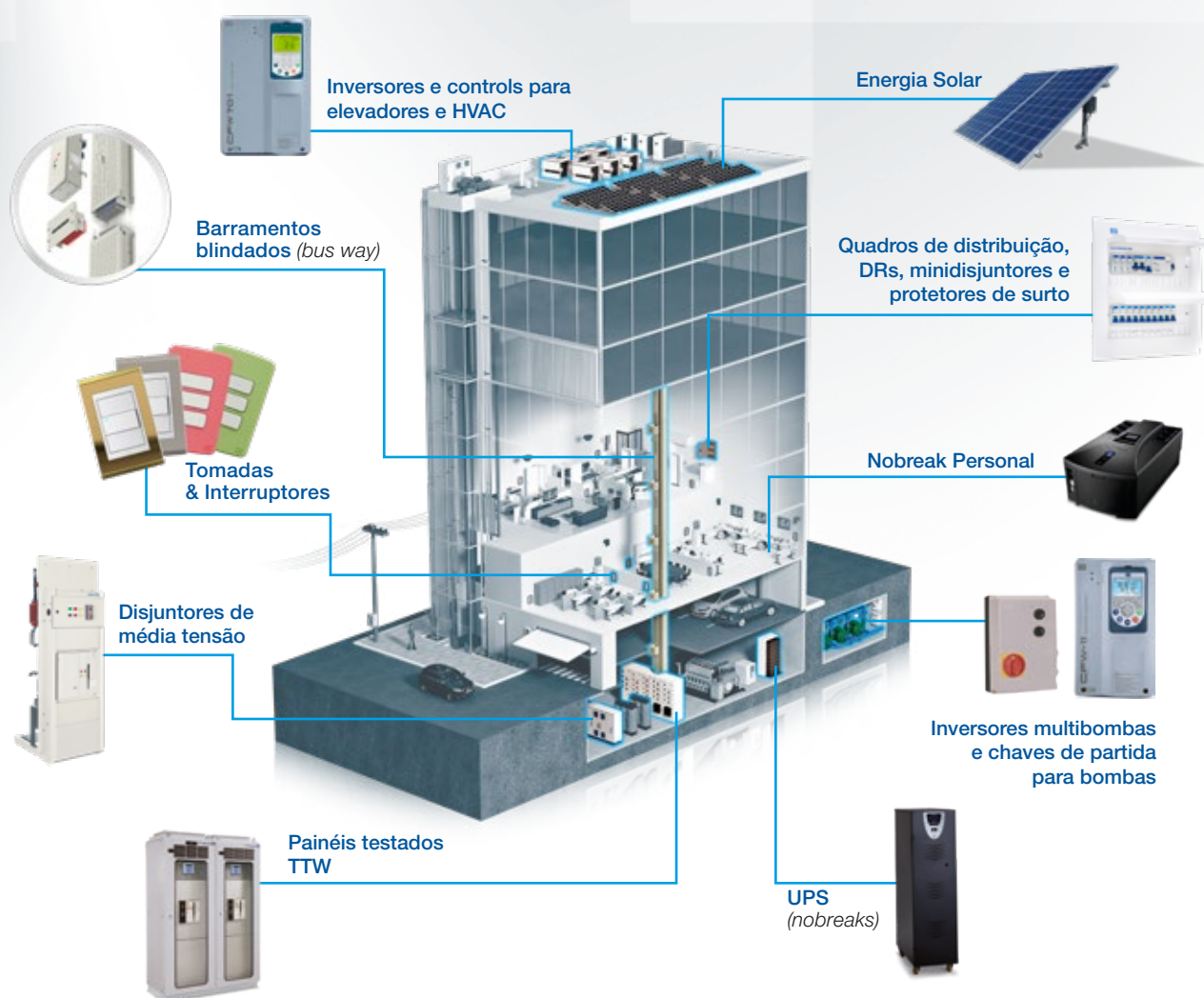

Excelência é desenvolver soluções que aumentem a produtividade de nossos clientes, com uma linha completa para automação industrial.

Acesse: [www.weg.net](http://www.weg.net)

 [youtube.com/wegvideos](https://youtube.com/wegvideos)



Grupo WEG - Unidade Automação  
Jaraguá do Sul - SC - Brasil  
Telefone: (47) 3276-4000  
[automacao@weg.net](mailto:automacao@weg.net)  
[www.weg.net](http://www.weg.net)  
[www.youtube.com/wegvideos](http://www.youtube.com/wegvideos)  
[@weg\\_wr](https://www.instagram.com/weg_wr)

