

KN1A-01

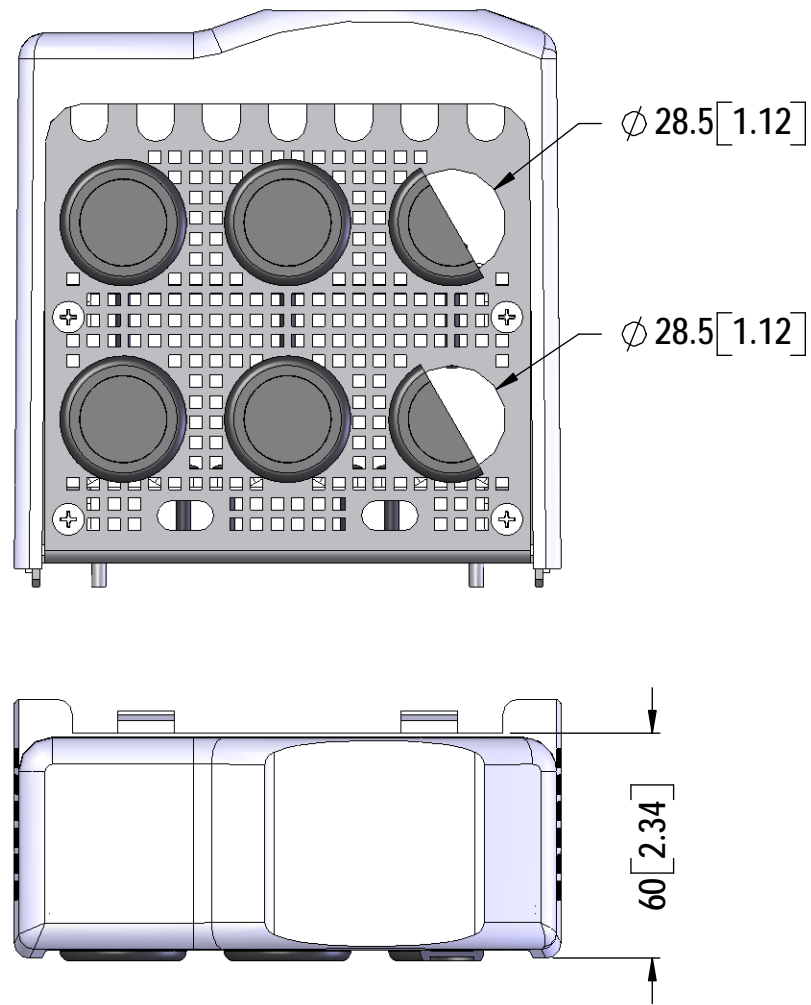

KN1B-01

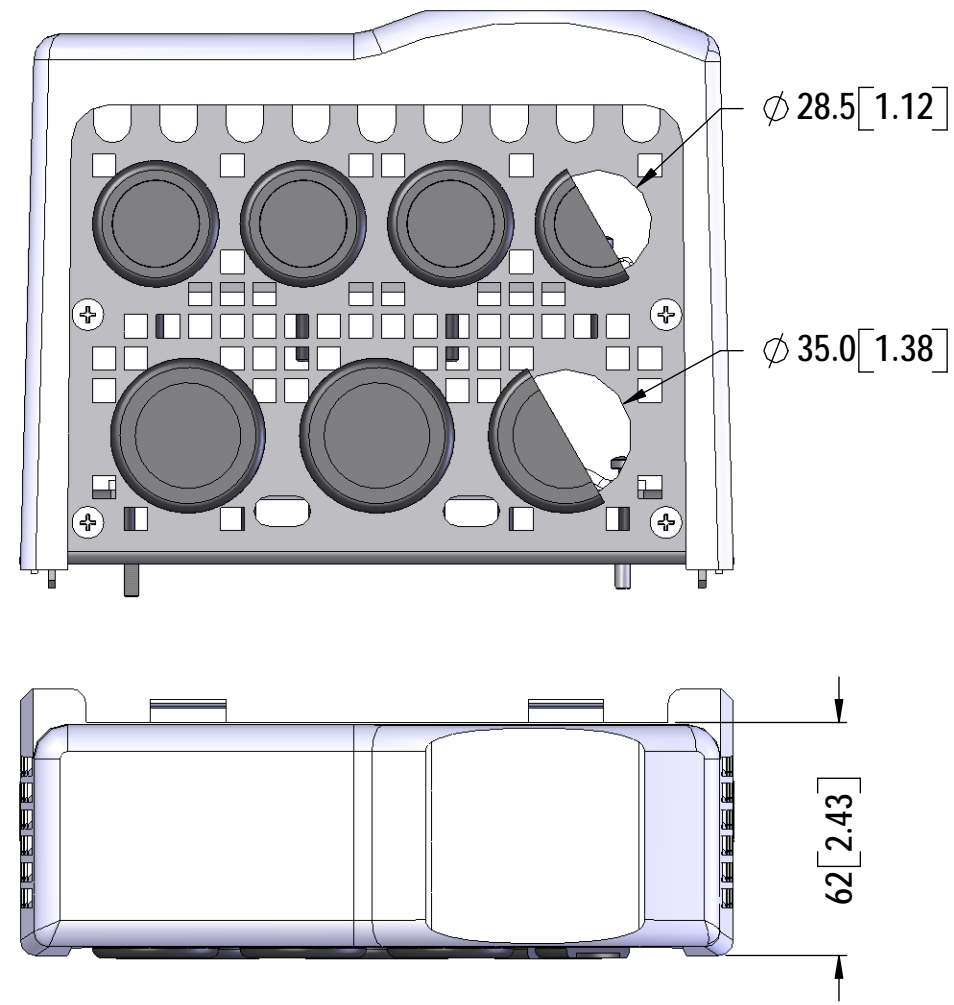

KN1C-01

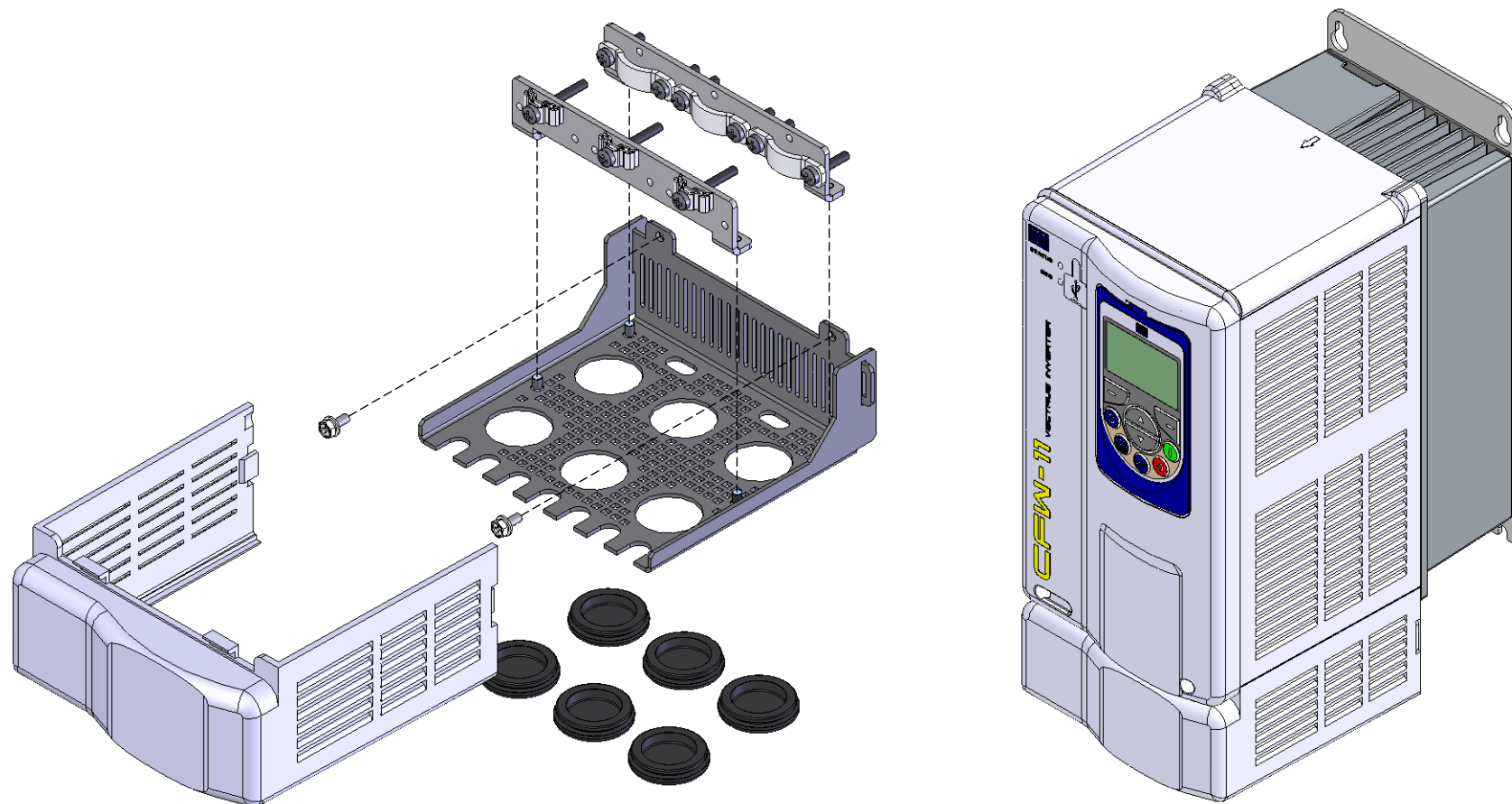
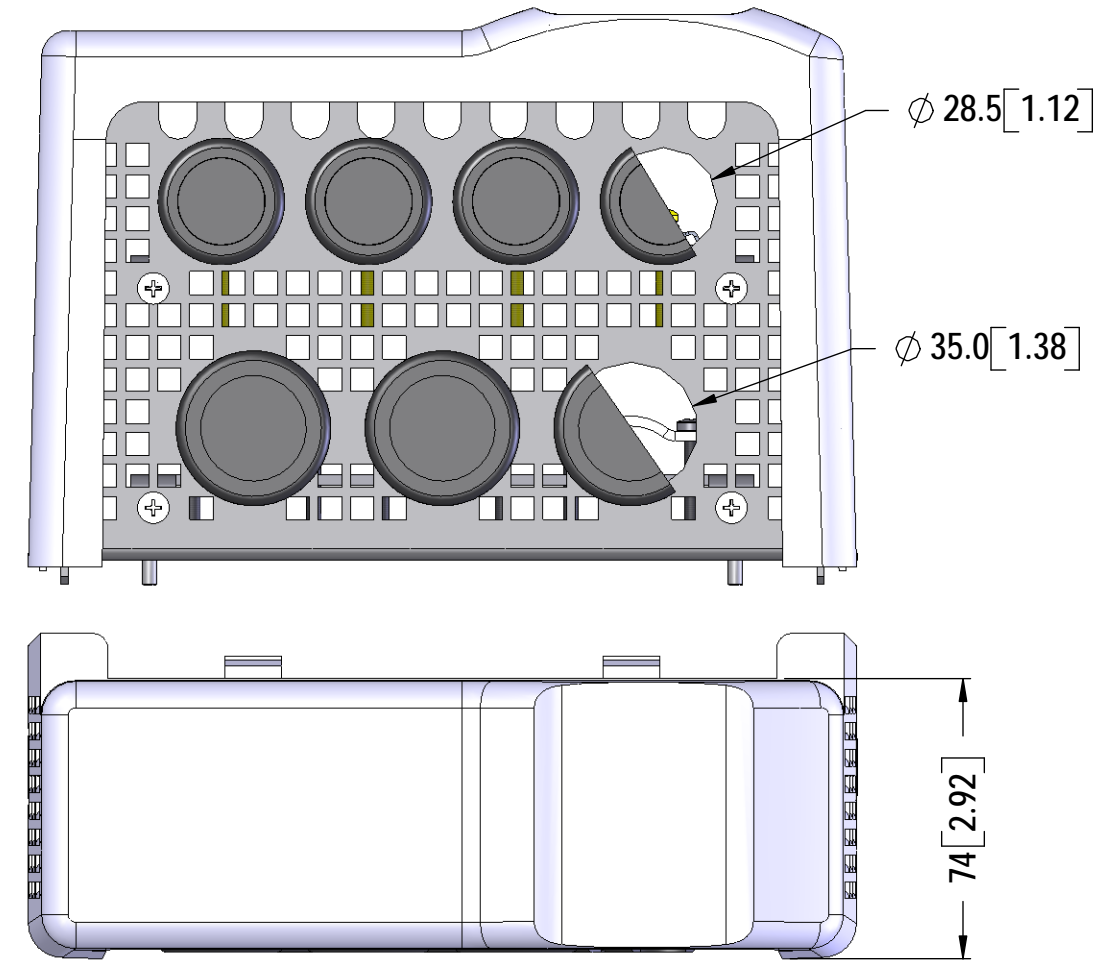

Instructions / Instrucciones / Instruções

- For fixing the kit first remove the HMI and front cover.
- Para fijar el kit, primero quitar el HMI y la tapa frontal.
- Para fixar o kit, primeiro retire a HMI e a tampa frontal.