

Regenerative Converter Convertidor Regenerativo Conversor Regenerativo



CFW 09



User's
Guide

Guía del
Usuario

Manual do
Usuário

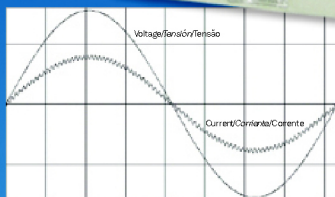

Motoring/Motorización/Motorização

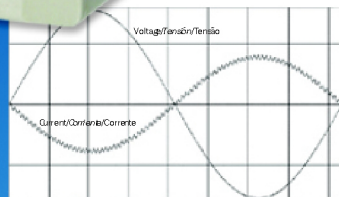

Braking/Frenado/Frenagem

REGENERATIVE CONVERTER MANUAL

Series: CFW-09RB

Software: version 1.2X

0899.4789 E/5

04/2004



ATTENTION!

It is very important to check if the inverter software is the same as indicated above.

Summary of Revisions

The Table below describes all revisions made to this Manual.

Revision	Description	Pages
1	First Edition	-
2	Change pre-charge	2
3	Included currents up 600A	5
4	Change RL 1 software-programming	5

Quick Parameter Reference, Fault and Status Messages

1	Parameters	05
2	Fault Messages	09
3	Other Messages	09

CHAPTER 1

General Information

1.1	About this Manual	10
	1.1.1 Harmonics	10
	1.1.2 Braking	18
	1.1.3 Application	21
1.2	CFW-09RB Simplified Block Diagram	24

CHAPTER 2

Electrical Installation

2.1	European EMC Directive	27
-----	------------------------------	----

CHAPTER 3

Start-up

3.1	Pre-Power Checks	28
3.2	Initial Power-up	28

CHAPTER 4

Keypad (HMI) Operation

4.1	Description of the CFW-09RB-LCD Keypad	30
4.2	Use of the Keypad (HMI)	31
	4.2.1 Use of the Keypad (HMI)	32
	4.2.2 Signalling/Indication on the HMI Displays	32
4.3	Parameter Programming	33
	4.3.1 Parameter Selection/Programming	33

CHAPTER 5

Detailed Parameter Description

5.1	Access and Read Only Parameter - P000...P099	35
5.2	Regulation Parameters - P100...P199	38
5.3	Configuration Parameters - P200...P399	40

CHAPTER 6

Diagnostics and Troubleshooting

6.1	Faults and Possible Causes	47
-----	----------------------------------	----

Table of Contents

CHAPTER 7

Technical Characteristics

7.1	Power Data	50
	7.1.1 220 - 230V Power Supply	50
	7.1.2 380 - 480V Power Supply	50

APPENDIX A

Switching Frequency Filter

.....	52
-------	----

APPENDIX B

CFW-09RB Line Reactor

.....	53
-------	----

QUICK PARAMETER REFERENCE, FAULT AND STATUS MESSAGES

Software: V1.2X

Application:

Model:

Serial Number:

Responsible:

Date: / / .

1. Parameters

Parameter	Description	Adjustable Range	Factory Setting	User's Setting	Page
P000	Parameter Access	0...999	0		35
Read Only Parameters LEITURA P001 ... P099					
P002	Line Voltage	0...600			35
P003	Input Current	0...2600 A			35
P004	DC Link Voltage	0...1077 V			35
P006	Rectifier Status	<ul style="list-style-type: none"> • rdy • run • Sub • EXY 			35
P010	Input Power	0.0...1200 kW			35
P012	DI1...DI2 Status	<ul style="list-style-type: none"> • A = Active • I = Inactive 			36
P013	DO1, DO2, RL1, RL2, RL3 Status	<ul style="list-style-type: none"> • A = Ativa • I = Inativa 			36
P014	Last Fault	E00...E41			36
P015	Second Previous Fault	E00...E41			36
P016	Third Previous Fault	E00...E41			36
P017	Fourth Previous Fault	E00...E41			36
P022	WEG use	0%...100%			37
P023	Software Version	1.0X			37
P025	A/D Iv value	0...1023			37
P026	A/D Iw value	0...1023			37
P027	WEG use	-999...999			37
P028	WEG use	0...2100			37
P029	WEG use	0...2100			37
P042	Time powered	0...65530 h			37
P043	Time Enabled	0...6553 h			37
Regulation Parameters P120 ... P199					
Reactive Current Reference					
P121	Reactive Current Reference	-100%...100%	0.0%		37
DC Voltage Regulation					
P151	DC Voltage Level	<ul style="list-style-type: none"> • 322V...394V (P296=0) • 556V...680V (P296=1) • 585V...715V (P296=2) • 646V...790V (P296=3) • 695V...825V (P296=4) 	358V 618V 650V 718V 750V		38
Overload Currents					
P156	Overload Current - 100%	0...1.3xP295	1.1xP295		38

Parameter	Description	Adjustable Range	Factory Setting	User's Setting	Page
DC Link Voltage Regulation					
P161	Proportional Gain	0.0...63.9	5.0		38
P162	Integral Gain	0.000...9.999	0.009		39
Input Current Regulation					
P167	Proportional Gain	0.00...1.99	0.7		40
P168	Integral Gain	0.000...1.999	0.250		40
P169	Maximum Braking Current	0...150%xP295	100% (P295)		40
P170	Maximum Motoring Current	0...150%xP295	100% (P295)		40
Input Reactive Current regulation					
P175	Proportional Gain	0.0...31.9	3.3		40
P176	Integral Gain	0.000...9.999	0.067		40
P179	Maximum Reactive Current	0...120%	120%		40
P180	Ractive Generation Point	0...120%	120%		40
CONFIGURATION					
Parameters		P200 ... P399			
P200	Password	0=Off 1=On	1=On		40
P201	Language Selection	0=Portuguese 1=English 2=Spanish	To be defined by the user		41
P204 (1)	Load/save Parameters	0=Not used 1=Not used 2=Not used 3=Reset P043 4=Not used 5=Loads factory default	0		41
P205	Display Default Selection	0=P002 1=P003 2=P004 3=P006 4=P010 5=P042 6=P043	2=P002		41
P206	Auto-Reset Time	0...255s	0s		41
P218	LCD Display Contrast Adjustment	0...150	127		41
Analog Outputs					
P251	Analog Output AO1 Function	0=Line Voltage 1=Input Current 2=Link Voltage 3=Input Power	0=Line Voltage		42
P252	Analog Output AO1 Gain	0.000 ... 9.999	1.000		42
P253	Analog Output AO2 Function	0=Line Voltage 1=Input Current 2=Link Voltage 3=INput Power	0=Line Voltage		42
P254	Analog Output AO2 Gain	0.000 ... 9.999	1.000		42
P255	Analog Output AO3 Function (Requires optional I/O expansion board EBA or EBB)	0=Line Voltage 1=Input Current 2=Link Voltage 3=INput Power More than 21 signals for exclusive WEG use	0=Line Voltage		42

Parameter	Description	Adjustable Range	Factory Setting	User's Setting	Page
P256	Analog Output AO3 Gain	0.000 ... 9.999	1.000		42
P257	Analog Output AO4 Function (requires optional I/O expansion board EBA or EBB)	0=Line Voltage 1=Input Current 2=DC Link Voltage 3=INout Power More than 21signals for exclusive WEG use	0=Line Voltage		42
P258	Analog Output AO4 Gain	0.000 ... 9.999	1.000		42
Digital Inputs					
P263 (1)	Digital Input DI1 Function	2=General Enable	2=General Enable		43
P264 (1)	Digital Input DI2 Function	4=Without external Fault	4=Without ext. Fault		43
Saídas Digitais					
P275 (1)	Output DO1 Function (requires opr=tional I/O expansion board EBA or EBB)	0...10=Not used 11=run 12=ready 13=No Fuault 14=No E00 15=No E01+E02+E03 16=No E04 17=No E05 18...23=Not used 24=Preload OK 25=With fault 26=Not used	0=Not used		44
P276 (1)	Output DO2 Function (requires optional I/O expansion Board EBA or EBB)	0...10=Not used 11=run 12=ready 13=No fault 14=No E00 15=No E01+E02+E03 16=No E04 17=No E05 18...23=Not used 24=Preload OK 25=With Fault 26=Not used	0=Not used		44
P277 (1)	Relay RL1 Function	0...10=Not used 11=run 12=ready 13=No fault 14=No E00 15=No E01+E02+E03 16=No E04 17=No E05 18...23=Not used 24=Preload OK 25=No fault 26=Not used	24=Preload OK		44

CFW-09RB - QUICK PARAMETER REFERENCE

Parameter	Description	Adjustable Range	Factory Setting	User's Setting	Page
P279 (1)	Relay RL2 Function	0...10=Not used 11=run 12=ready 13=No fault 14=No E00 15=No E01+E02+E03 16=No E04 17=No E05 18...23=Not used 24=Preload OK 25=No fault 26=Not used	13=No fault		44
P280 (1)	Relay RL3 Function	0...10=Not used 11=run 12=ready 13=No fault 14=No E00 15=No E01+E02+E03 16=No E04 17=No E05 18...23=Not used 24=Preload OK 25=Wiuth fualt 26=Not used	11=run		44
Rectifier Data					
P295 (1)	Rated Current	17=86.0A 18=105.0A 19=130.0A 20=142.0A 21=180.0A 22=240.0A 23=361.0A 24=450.0A 25=600.0A 26=650.0A 27=810.0A 28=1080.0A 29=1215.0A 30=1620.0A	According to the rated rectifier current		45
P296 (1)	Rated Voltage	0=220V/230V 1=380V 2=400V/415V 3=440V/460V 4=480V	According to the rated rectifier voltage		46
P297 (1)	Switching Frequency	1=2.5 kHz 2=5.0 kHz	2=5.0 kHz		46

(1) Parameters can be changed only when rectifier is disabled

2. Fault Messages

Display	Description	Page
E00	Overcurrent at the Input	47
E01	DC Link Overvoltage	47
E02	DC Link Undervoltage	47
E03	Power Supply Undervoltage/Phase Loss	48
E04(*)	Inverter Overtemperature/ Pre-charge Circuit Failure	
E05	Output Overload (lxt function)	48
E06	External Fault	48
E08	CPU Error (watchdog)	48
E09	Program Memory Error	48
E16	Line Overvoltage	48
E31	Keypad Connection Fault	48
E41	Self-Diagnosis Fault	48

(*) O E04 can be "Preload Circuit Fault" only for the following models:
86A/105A/142A (380V-480V) e 70A/ 86A/105A/130A (220V-230V).

3. Other Messages

Display	Description
rdy	Rectifier is ready to be Enabled
run	Rectifier is Enabled
Sub	Rectifier with too low Voltage for Inverter Operation (undervoltage)

GENERAL INFORMATION

This purpose of this Manual is to provide information about the CFW-09RB regenerative converter. Before reading this manual, read the CFW-09 Frequency Inverter Manual. All information regarding Safety Notices, Version of Software, Nameplate, Receiving and Storing, Mechanical Installation and Warranty Terms described in that Manual should also be considered for this rectifier line.

1.1 ABOUT THE CFW-09RB

Figure 1 shows a standard induction motor drive with its main components: the input reactance, the rectifier bridge, the DC link, the DC link inductor, the output IGBT inverter bridge, the induction motor and the load.

The input reactance and the DC link inductor may be present simultaneously or not.

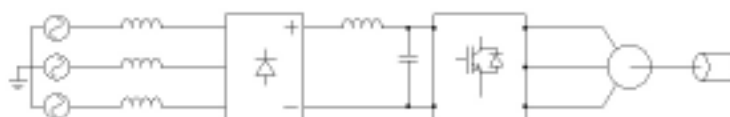

Figure 1.1 - Induction Motor Drive System

This kind of system has two major drawbacks: the increase of the harmonic content on the line and braking loads with high inertia, or loads running at high speeds and requiring short braking times. The increase of the harmonic content at the line occurs with any load type. The braking problem occurs with loads such as sugar centrifuges, dynamometers, overhead cranes and web winders.

The CFW-09 inverter with RB option (Regenerative Braking) is WEG solution for these problems (Fig.1.2).



Figure 1.2 - CFW-09 with RB Option

1.1.1 Harmonics

For the electrical system sake, the resistive load is the ideal one. This because all the transmitted energy is converted into useful work.

Always when inductive loads, such as motors, are coupled, part of the transmitted energy is used to create the electromagnetic fields inherent in the load functioning. A correct application of the capacitive banks will solve this problem. With the increasing use of frequency inverters both in the industrial and the appliance sectors, another phenomenon becomes important: the harmonics

Please refer to Figure 1.3.

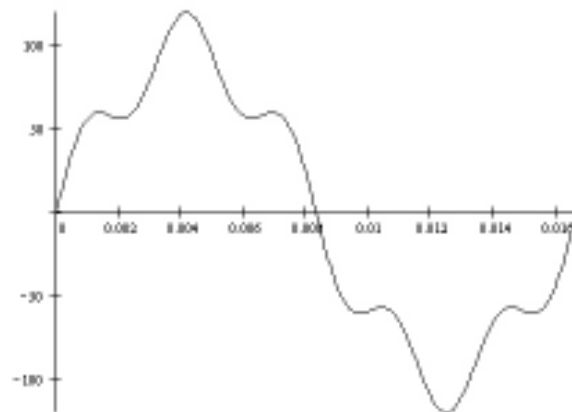

Figure 1.3 - Complex Wave Form

It seems to be a sine wave with large distortion. Through the mathematics one can prove that the signal from Fig. 1.3 is formed by the sum of several sine waves of different frequencies and amplitudes. (Fig. 1.4).

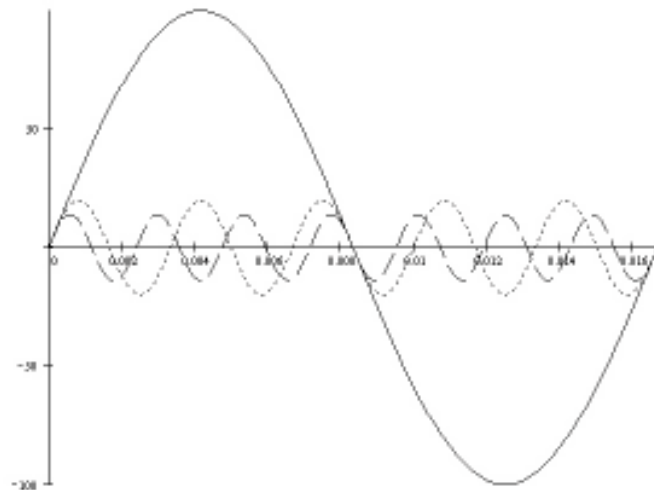

Figure 1.4 - Harmonic Decomposition of the signal of the Figure 1.3.

By analyzing the Fig. 1.4, one can note that there is a sine wave of larger amplitude, known as fundamental harmonic or first harmonic.

In this case it has a peak value equal to 100 and a frequency of 60 Hz. Other sine waves (harmonics) are analysed relating to the fundamental harmonic: one of these waves has a peak of 20 Volts (or 20% of the fundamental) and a frequency of 300 Hz (five times the fundamental, therefore the name fifth harmonic): the other wave has a peak of 14 Volts (approx. 14% of the fundamental) and a frequency of 420 Hz (seven times the fundamental, thus the seventh harmonic). One can say that the more complex the signal, more harmonics form this signal, i.e., there can be present the eleventh harmonic, the thirteenth harmonic and so on. There are also even harmonics (second, fourth, etc.), but in a general way these harmonics are not present in the signals of our interest or they have a very low value.

The diode rectifiers operate in such a way that the line energy is transferred only to the output capacitor bank when the line voltage is higher than the capacitor bank voltage. Therefore the current drained by the rectifier bridge is pulsed.

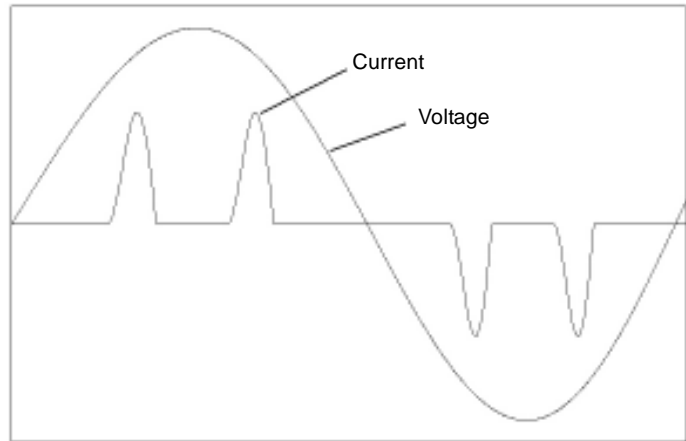

Figure 1.5 - Wave Form of the Phase Voltage and the Input Current of a Three-Phase Diode Bridge.

The rectifier input current harmonics have been extensively studied and it is known that the harmonic order is given by the following formula:

$$\eta = P \cdot k \pm 1 \quad (1)$$

where k can assume values as 1, 2, 3...and P is the number of pulses of the rectifier bridge.

A complete three-phase bridge has 6 pulses, thus P=6. 5th, 7th, 11th, etc. harmonics will be present. Thus in a single-phase bridge P=2 and we will have additionally the third harmonic. Consequently in a bridge with twelve pulse we won't have the third, the fifth and the seventh harmonics.

Which will be the problem when we have a high harmonic content in the input current? The problem will be that only the first harmonic contributes to the energy transference between the source and the load, i.e., only this harmonic produces a useful work. The other harmonics will produce only losses in the system, causing overheating on equipment such as generators and transformers. Thus in order to compensate this effect, the equipment must be oversized, and consequently increasing the end costs. Figure 1.6 shows another effect of these harmonics: the current drained by the non-linear load (in this case, the rectifier) has harmonics that produces proportional system impedance drops, causing harmonics in the line voltage that supplies the motor. Also the motor will drain a current with some harmonic content. Besides this distorted supply will generate an additional motor overheating. Although the figure shows only one motor as linear load, we must consider that this load may be in the same installation or even in adjacent factories.

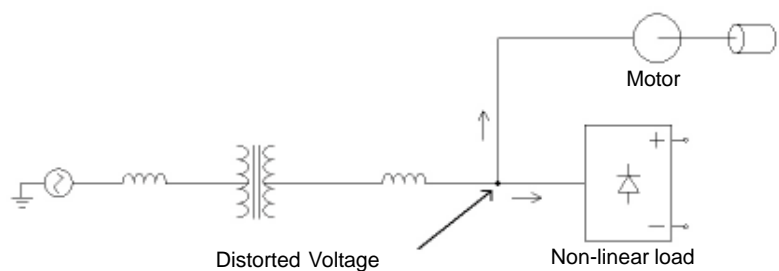

Figure 1.6 - Effects of the harmonics in the system

Although we had discussed only uncontrolled rectifier bridges, we can say that the effects of thyristor bridges are very similar. The main difference is as the triggering angle increases the delay between the voltage and the fundamental component of the input current also increases. To consider the harmonic effects in the system, a new concept of power factor had to be developed. In the past, when the loads were only capacitive, inductive and resistive, the power factor was defined as the cosine of the angle between the voltage and the current. This angle is measured considering that the period of the voltage of a 60 Hz line is a little more than 16 ms, corresponding to 360 degrees. Fig. 1.7a shows a voltage advanced in some milliseconds relating to the current. The circuit is inductive and the cosine of the angle converted from milliseconds to grades is positive and smaller than 1. Fig. 1.7b shows a current advanced relating to the voltage. The circuit is capacitive and the cosine of the angle is smaller than zero and larger than a negative value. If this circuit would be only resistive, the voltage would be in phase with the current, providing an angle equal to zero and a cosine equal to 1.

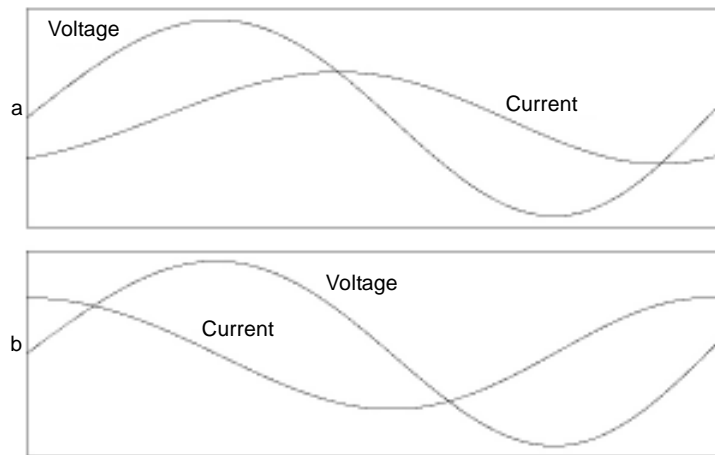

Figure 1.7 - Inductive and Capacitive Circuit

This former power factor has been redefined as displacement factor. This difference is that in this new factor the angle is measured between the fundamental of the voltage and the fundamental of the current. To consider the harmonic content of the current, another factor, designated as harmonic current distortion rate, has been created. This factor is calculated by adding the rms value of all harmonics after that extracting the square root of this sum and dividing the result by the fundamental rms value.

$$TDH (I)\% = \frac{\sqrt{\sum_{h=2}^n I_h^2}}{I_1} \tag{2}$$

Formula 3 shows how are combined the displacement factor and the harmonic current distortion rate in the new power factor definition:

$$FP = \frac{\cos \phi_1}{\sqrt{1 + TDH^2}} \tag{3}$$

The method selection to minimize the harmonic content depends basically on the costs and the standards that have to be met. The standards change from country to country and the distortion levels are generally established according to the involved power or according to the effects on the system. There are even some standards about EMC that deal with this subject. One of the most used method is the introduction in the supply of a serial inductance, also know as line reactance. This line reactance is generally specified according to the percentual line voltage drop. As the inductance increases, the transference of the line energy to the capacitor bank will become less abrupt, thus resulting in smaller current pulse amplitudes and consequently decreasing the harmonic content. As the reactances generate drops higher than 4%, there will no be a perceptible effect (Fig. 1.8). Through this method it is possible to obtain distortion rates in the order of 39%.

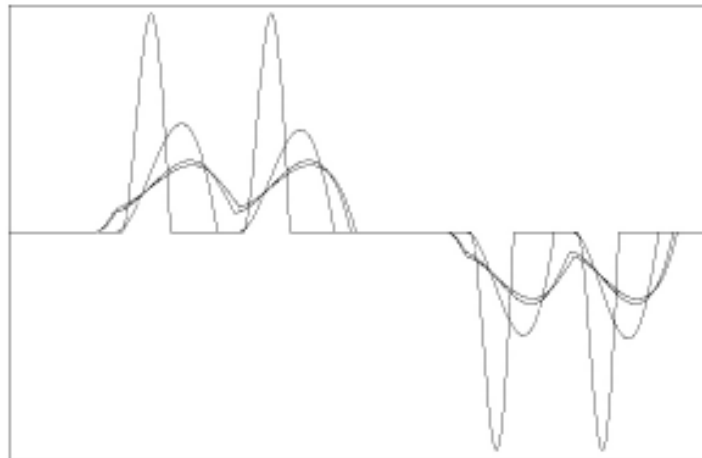

Figure 1.8 - Currents with Input Reactance

Another applied method adds an inductor in the inverter DC link. The effects are the same, but the shape of the input current wave is slight different (Fig. 1.9).

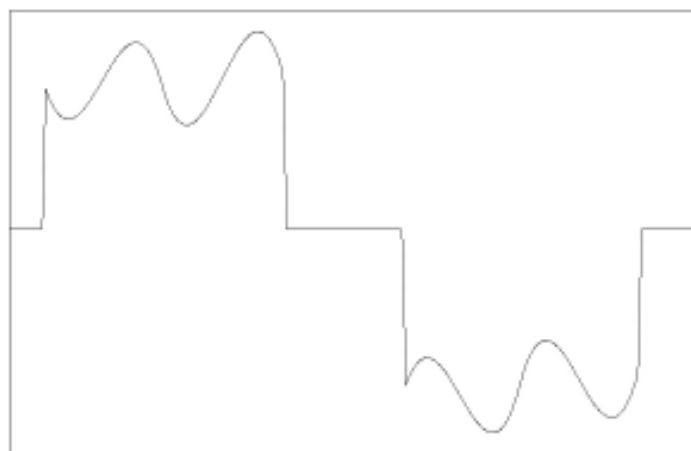

Figure 1.9 - Input Current with Inductor in the Link

There are advantages and disadvantages by applying these methods. The line reactance reduces the rms current of the diodes on the rectifier bridge, reduces the current ripples in the capacitor of the DC link circuit (thus increasing their useful life) and delimits the “notches” area,

caused by transitory short-circuits in the electric network during the commutation of the diodes with different arms in the rectifier bridge. These “notches” are deformations in the line voltage which depth and area are regulated by some standards. (Fig. 1.10 and 1.11).

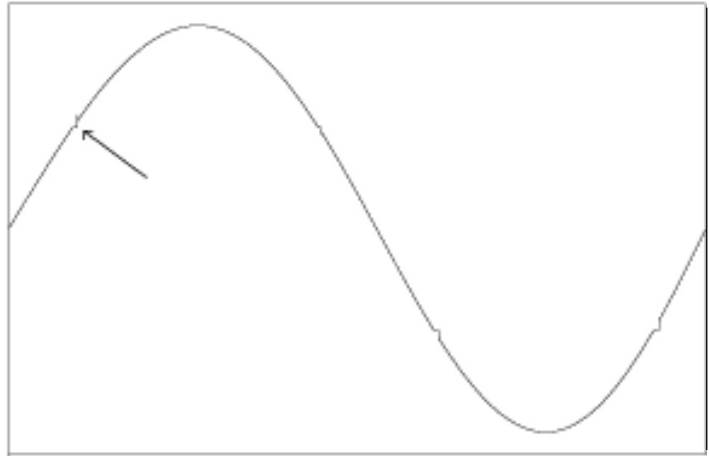

Figure 1.10 - A “NOTCH”

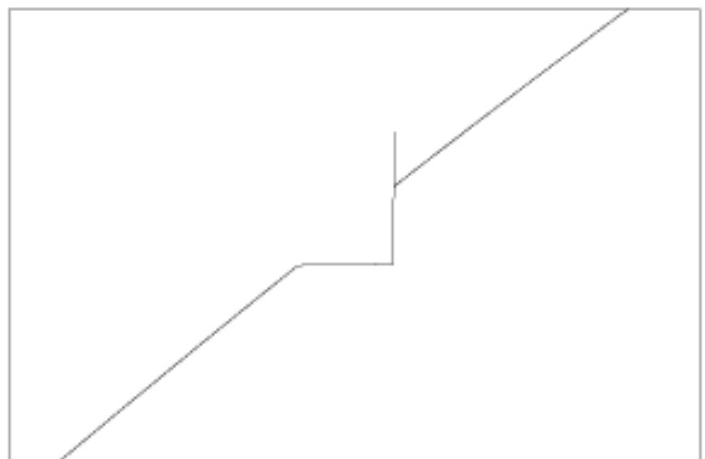

Figure 1.11 - Close to a NOTCH

The line reactance also reduces the effects of the line voltage peaks on the inverter. These peaks cause a locking due to overvoltages in the DC link. The disadvantages of the line reactance are the volume and the drop in the average voltage of the inverter DC link, thus limiting the maximum voltage of the driven motor and consequently its torque.

The link inductor has a smaller volume and does not cause drop in the average DC link voltage, but it does not have the same limiting effect of the line peaks, when compared with the line reactance. The link inductor promotes the introduction of “notches” in the line, as well as produces undesired oscillations due to resonances with elements of the system. Another solution is the association of rectifiers to obtain a higher number of pulses (12, 18 and 24 pulses, higher numbers are less usual). The most used solution is the configuration for 12 pulses that may have the rectifier bridges series or parallel connected. In addition, these bridges can be of controlled or uncontrolled type.

The functioning principle is the same: a transformer with two secondary windings, one winding wye connected and the other delta connected with the voltage shifted in thirty degrees, or with two transformers, one transformer with the secondary winding wye connected and the other transformer with the secondary winding Delta connected (Fig. 1.12). The effect is the same. Each rectifier generates the same harmonic level, but the input voltage phase shift realizes that the harmonics of the order below the eleventh are cancelled in the primary winding. The reactances at the rectifier inputs may exist physically or may be only the dispersion of the transformers. Other important information: as the harmonics cancel only each other in the primary winding, the transformers must be oversized to support the harmonics.

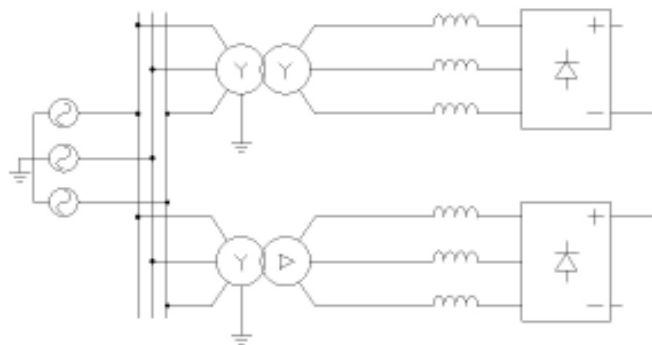

Figure 1.12 - 12 Pulse Rectifier with two transformers

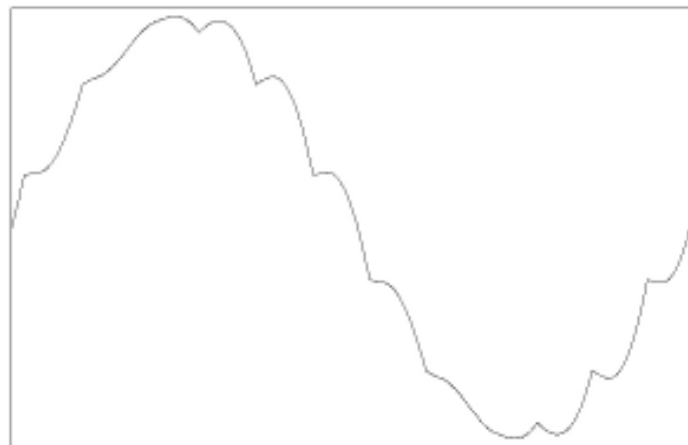

Figure 1.13 - 12 Pulse Rectifier with two transformers

The theoretical harmonic distortion rate in the primary winding of a 12 pulse rectifier lies near 6% (Fig.1.13). However a line unbalance around 2.5% and a difference of only one degree in the voltage phase shift already increases distortion in simulations to around 10%. Nevertheless in the practice these values can increase up to 14%, probably due to dispersion unbalance of the transformers combined with the factors mentioned above.

Another solutions can be adopted to solve this problem. All these solutions introduce some device that is serial or parallel connected to the rectifier supply. Among these solutions are low-pass filters combined with transformers and capacitors connected in series with the line. These filters result in distortion rates in the range from 8 to 10% and power factors in the order of 0.9 to 0.95.

Another solution is the application of an active filter, another kind of converter connected at the inverter input. This converter absorbs to some extent the harmonic content that is generated by the rectifier. With this solution distortion rates in the order of 4% can be achieved, but this solution is very expensive.

Also filters tuned to a serial harmonic and producing significant reduction at that harmonic can be used, but this alternative will also generate a significant drop of the average voltage in the DC link. The tuned filter can be also connected parallel to the supply, but here they can generate oscillations due to the resonance with other elements of the system.

Another additional undesirable effect can be generated: as the filter offers to the harmonics a path of low impedance, it can drain the harmonics from a nearby factory, for instance, producing filter overload. To minimize these effects, you must add a serial reactance.

But this solution will increase still more the costs of the installation that are already high.

Fig. 1.14 shows the main components of a CFW-09 RB drive.

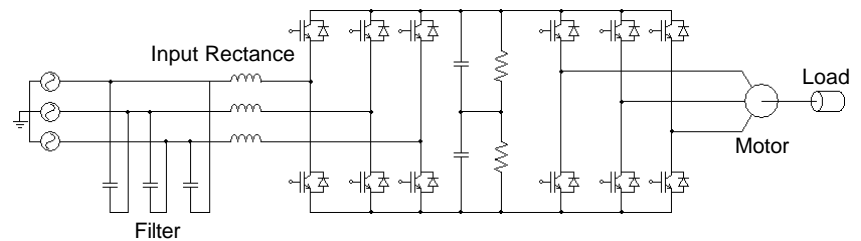

Figure 1.14 - Simplified Diagram of a CFW-09 RB Drive

As shown in the Figure above, the CFW-09RB unit has a capacitor bank and a IGBT bridge. Externally is mounted a line reactance and a capacitive filter. Through the switching of the IGBT bridge, a controlled energy transfer from the line to the capacitor bank is enabled. One can say that through this switching process, the CFW-09RB emulates a resistive load. To avoid the interference of the bridge switching process on other line loads, a capacitive filter is provided. To complete this drive, the application of a CFW-09HD is required to control the motor speed and its load. Fig. 1.14 shows this option through the second IGBT bridge.

Fig. 1.15 shows the shapes of the voltage wave and the input current of a drive for a 50 HP motor, where the motor at the drive output is at normal operation.

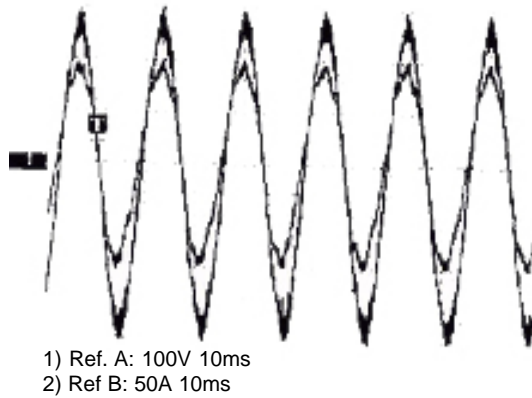

Figure 1.15 - Input Voltage and Current of a CFW-09RB

1.1.2 Braking

Fig. 1.16 shows two possible conditions of a conventional drive. In case "a", the inverter drives the motor to reach the speed that is transmitted to the load. This load has a characteristic known as inertia, which has the tendency to resist to every change in the movement status. But when the load stops, or even a reduction of the speed is required, the inverter supplies the motor with a lower voltage frequency and amplitude, thus lowering the speed of the electromagnetic rotating field inside the motor and consequently, reducing the motor speed. However, the load does not change its speed instantaneously, and now the load runs at a higher speed than the field (the slip becomes negative).

In this condition, the motor runs as generator (Fig. 1.16b), the voltage that is induced into the rotor has a higher amplitude than the supply. Part of the generated energy is dissipated by the IGBT bridge part by the motor itself.

Another part is rectified in the IGBT diode bridge and accumulated in the DC link capacitor bank and so the input diode bridge becomes inversely polarized, thus interrupting the line power flow to the DC link capacitor bank. Part of this energy is feedback through the IGBT's to magnetize the motor.

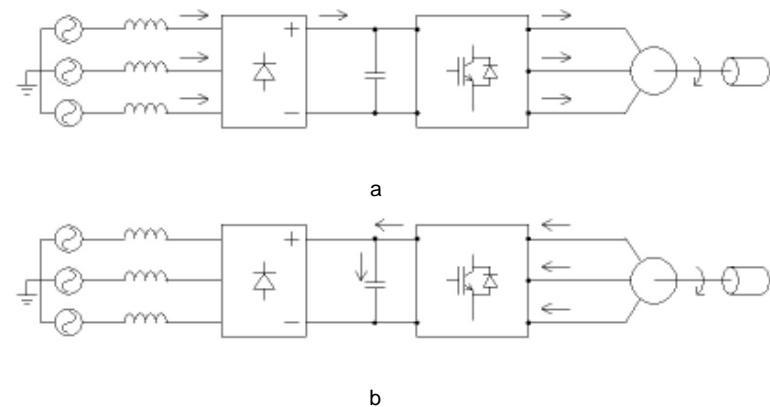

Figure 1.16 - Braking with a conventional Drive

If nothing is done, the voltage in the capacitors will increase until the overvoltage protection device in the DC link trips out. So the IGBT's output pulses are shut down, the motor demagnetizes and stops to operate as generator. The mechanical losses of the system (such as friction losses) will bring the load to standstill (this time is proportional to the system inertia). Many drives require a speed reduction or even a standstill within a predetermined time without the presence of overvoltage in the DC link.

As the inertia acts as an energy accumulator, one can say that the faster the energy generated by the motor is drained, the higher will be the braking torque. Depending on the application (time to bring the motor to standstill, or speed reduction) and on the cost of the energy that is returned to the DC link circuit, there are several alternatives.

The first alternative is the DC current injection into the motor stator. The inverter supplies the motor stator with DC current and as there is no rotating field, no energy is returned. The currents induced into the rotor generates resistive losses and the braking torque will be proportional to these losses. As these losses are very low, this method is seldom used.

Other alternative is the injection of harmonics into the stator. As this method generates high noises and as it shows a braking torque with high ripples, it is not used so often.

The CFW-09 inverter line offers an additional option, that is the Optimal Braking. When a braking is needed in the vector control mode, the inverter maximize the motor losses, thus offering a high braking torque.

The most applied alternative is the rheostatic braking Fig. 1.17.

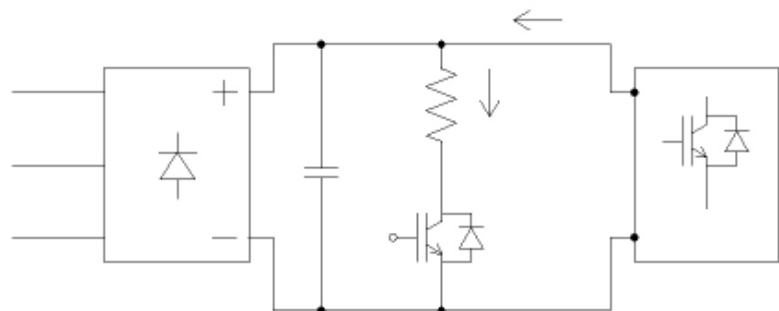

Figure 1.17 - Rheostatic braking

This alternative consists in connecting a resistor through a DC link at the instant of the braking. Thus the energy that would be returned to the DC link will be dissipated in the form of heat. This is a simple solution, but depending on the involved energy, it will be very expensive.

A more efficient solution is the return of the energy to the line. This can be realized through the use of two antiparallel connected totally controlled rectifier bridges, or through diode and thyristor bridges (Fig. 1.18).

The main disadvantage of this method is the harmonic distortion rate and the variation of the displacement factor under load and all associated problems.

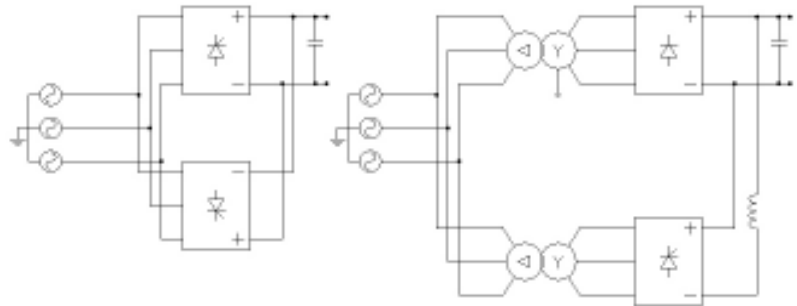

Figure 1.18 - Regeneration with thyristor bridges

CFW-09RB also enables the return of the energy to the line during the braking process (Fig. 1.19).

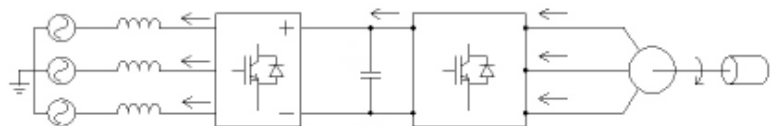

Figure 1.19 - CFW-09RB returning the energy to the line

Figure 1.20 shows the functioning principle. During the braking process, CFW-09RB operates as generator, by applying at its input a voltage with higher amplitude than the line voltage. This causes the reversion of the power flow. You can make an analogy with the electric system (Fig. 1.19).



Figure 1.20 - Electric System

In Fig. 1.20, V1 is equivalent to the line and V2 is equivalent to the CFW-09RB, thus as in the electric system, V1 and V2 are equivalent to two generators. The power flow is given by formula 4.

$$P = \frac{V1 \cdot V2}{XI} \cdot \text{sen } \delta \tag{4}$$

It is directly proportional to the product of the two generator voltages, divided by the impedance between them and multiplied by sine of the difference of the phase angle between the two sources. The CFW-09RB can change only the input amplitude or phase angle to return the energy to the line. The easiest solution is to change the amplitude (by increasing it). Fig. 1.21 shows the result of this alternative.

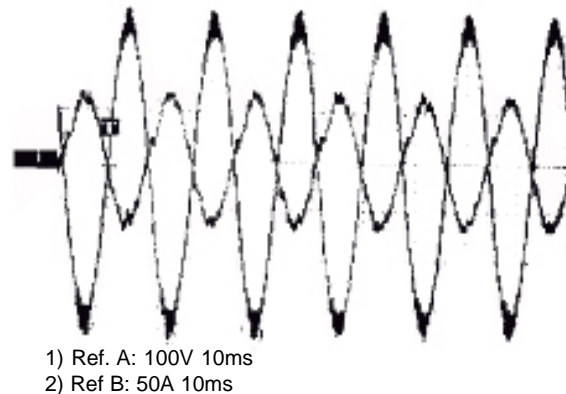

Figure 1.21 - Voltage and Current of a regenerating CFW-09RB

Fig. 1.21 shows the voltage and current wave shapes of a 50 HP drive, regenerating with 70% of the rated load.

1.1.3 Applications

As has been already mentioned, the CFW-09RB sizing should consider the output inverter. CFW-09RB is able to regenerate the same energy that it drains. But there are some additional details that can result into additional applications, for instance, by driving a motor with a higher voltage than the supply line in some models.

This is caused due to the fact that for generating a sine wave higher than the line and so regenerating the energy, the DC link voltage must be higher than that obtained with a conventional diode rectifier.

This is obtained through the switching of the input IGBTs, that gathers the energy into the input reactance and then is "pumps" it to the DC link.

Thus the input inverter has a voltage range to drive a motor with higher voltage. But this can be done only with the 380 V models that can supply 440 V motors and with the 400 to 460 V models that can supply 480 V motors. This product characteristic can be explored only after a more carefully analysis of the application.

A typical application of the CFW-09RB is sugar centrifuges. In this application, large part of the energy is consumed for the load acceleration within a predetermined time required to obtain a certain number of load cycles and consequently ensure the productivity. After the centrifuge has been accelerated to its maximum speed, only enough energy to compensate the system losses has to be supplied. As the load has a very high inertia, during the deceleration, all accumulated energy has to be dissipated somewhere or returned to the line. As there is still time restriction, a high braking torque is required. Figure 1.22 shows an example of a typical cycle of a sugar centrifuge.

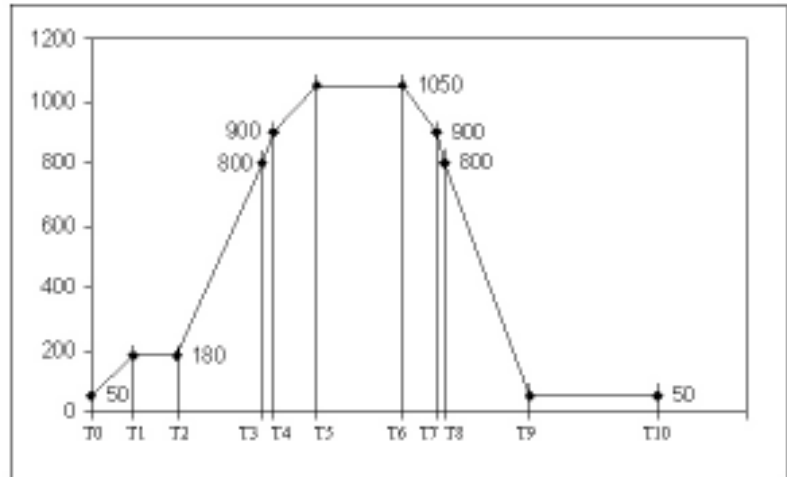

Figure 1.22 - Cycle of a Sugar Centrifuge

In the beginning, the centrifuge runs at 50 rpm, that is the "end of discharge" speed (T0). Then the centrifuge has to be accelerated up to the charging speed (T1-T2) within the shortest possible time in order to not delay the production cycle. In this case the speed increases from 50 to 180 rpm. After the charging speed is reached, starts the charging of the mass into the centrifuge and the inertia increases proportionally. The speed is maintained constant. After the charging process has been concluded (T2), the centrifuge is accelerated to the maximum speed, in this case, up to 1050 rpm (T5) and the inertia decreases due to the liquid phase separation process.

Though the speed increases linearly between T2 and T5, we will highlight other two important aspects from the Figure 1.22: first point as the centrifuge reaches the speed of 800 rpm (T3), and the liquid should be removed completely from the mass. The second point (T4), as the centrifuge reaches the rated motor speed, since we are considering the use of a VIII pole motor supplied with 440 V, 60 Hz. During certain time of the cycle the motor operates at constant power (field weakening). After the speed of 1050 rpm has been reached, the centrifuge can remain at this speed during a short time, when no mechanical restriction is present.

Then the machine is decelerated (T6-T9), and the speed decreases from 1050 rpm to 50 rpm, where occurs the energy regeneration to the line. At this speed is realized the discharging of the crystallized sugar (through steam injection) and the system inertia decreases. In this stage can be added also the device to scrape the sugar from the internal centrifuge walls. This process can generate a resistive torque of approx. 40% of the motor torque.

We suppose that for a charge of 2000 kg mass 20 s are required and that the centrifuge remains during 10 s at the maximum speed and that 40 s are required for the discharge of the crystallized sugar.

We suppose also that 22 cycles/hour are required.

We need also the system inertia during the cycle: 897 kg.m² for the centrifuge without load; 1875 kg.m² after the charging of 2000 kg mass and 1494 kg.m² after the centrifuging process and liquid removal. The motor inertia will not be considered, since it is very low when compared with the machine inertia. A 350 HP, VIII pole motor has an inertia of 20 kg.m², while a 500 HP motor has an inertia of 30 kg.m². Thus in the worst case, the motor will have an inertia lower than 5% of the centrifuge without load.

With 22 cycles/hour, we will have 163 s per cycle. When the known values are discounted (charging, discharging, etc.), we will have a net value of 93 s. Disregarding the acceleration time from the end of the discharging up to the charging speed (T0-T1), we may suppose that both the acceleration and the deceleration times last only 46 s. The equation 5 calculates the acceleration time of a load:

$$t_a = \frac{\omega \cdot (J_m + J_{CE})}{(C_{mm} - C_{rm})} \quad (5)$$

where:

- ω - rated speed in rad/s
- J_m - moment of inertia of the motor in kg.m²
- J_{CE} - moment of inertia of the load related to the shaft in kg.m²
- C_{mm} - Average motor torque in N.m
- C_{rm} - Resistive load torque in N.m

To convert from rpm into rad/second, multiply the rpm value by 0.105, that is the same as the multiplication by 2 and then the division of the value by 60. The motor inertia can be disregarded and the resistive load torque is supposed at max. 5% of the motor torque, due to the mechanical characteristics of the load. We suppose that the motor accelerates the max. inertia within 46 s, disregarding the time it operates in the area of constant power, where the torque is lower.

This assumption simplifies the estimation and the error will be in the order of 0.5%. In the case where the centrifuge reaches speeds above the rated speed (for instance, 1200 rpm), the sizing effects should be checked carefully.

The load should be accelerated from 180 rpm to 1050 rpm. This acceleration represents an increase of 870 rpm, that is equal to 91 rad/s. Thus:

$$46 = \frac{91 \cdot 1875}{(C_{mm} - 0.05 \cdot C_{mm})}$$

$$C_{mm} = \frac{91 \cdot 1875}{46 \cdot 0.95}$$

$$C_{mm} = 3909 \text{ N.m}$$

By looking in the catalog for a motor with this torque, we will find out a 500 HP (4000 N.m) motor, i. e., a 373 kW motor.

By verifying the value through Eq. 5, considering the motor inertia and the field weakening we will determine a time of 37.9 s to accelerate the load up to 900 rpm and a time of 7.7 s to accelerate the load from 900 to 1050 rpm. The total acceleration time will be of 45.6 s.

Thus we can conclude that the required CFW-9 should be the 600A, HD version (supplied by the DC link) to drive the motor and the RB (regenerative braking) to interface with the line.

1.2 CFW-09RB
SIMPLIFIED
BLOCK DIAGRAM

Figure 1.23 shows a simplified CFW-09RB block diagram.

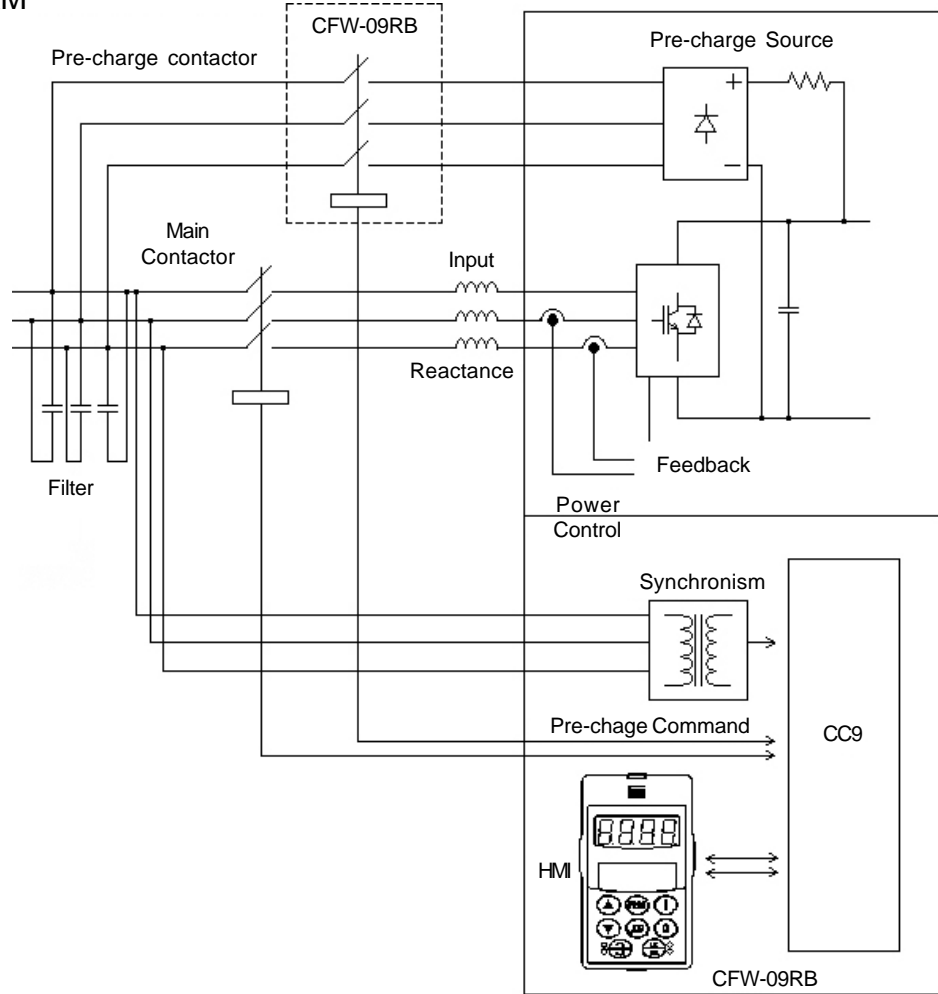

Figure 1.23 - Simplified CFW-09RB Block Diagram

ELECTRICAL INSTALLATION

- ☑ All information relating to the power/grounding connections, wire cross sections and voltage selection described in the CFW-09 Manual are also valid for the CFW-09RB unit.
- ☑ The CFW-09RB terminal connection are similar to the CFW-09 terminal connection, but their identification and use are different (Fig. 2.1).

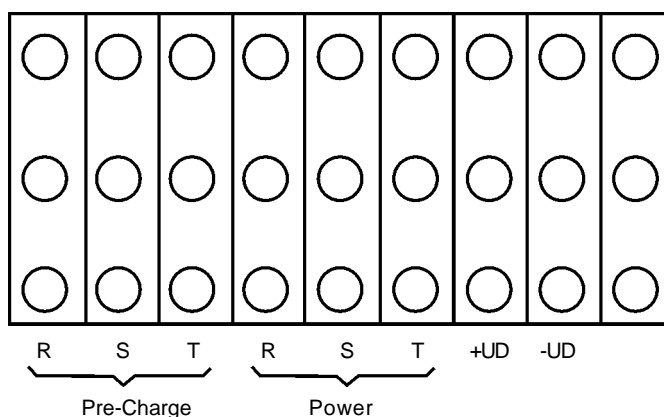

Figure 2.1 - Typical CFW-09RB terminal

- ☑ The first three terminals at the left of Figure 2.1 are used for the pre-charge and cooling supply. It is very important that this supply connection comes from the capacitive filter connection (see figure 1.23) and not from the power connection, where the IGBT's switching will interfere in the fan operation and give rise to overheating of the system.
- ☑ The next three terminals are required for the power connection, i. e., the input reactance is here connected.
- ☑ By following this order (from left to right), the next two terminals are used for the DC link outputs for the supply of other inverter(s). The last terminal is not used.
- ☑ The sizes 6 and 7 have the BR terminal that is not used.
- ☑ Figure 2.2 shows the Signal and the Control connections. The XC1 connector is used for the digital and analog signal connections and the XC1A connector is used for the relays.
- ☑ Figure 2.3 shows the synchronization connection details.
- ☑ Figure 2.4 shows more details about the pre-charge auxiliary relay connections. The auxiliary contactor of the pre-charge internal to the CFW-09RB is commanded by using the internal 220 V command and an external auxiliary contactor. This 220V circuit is galvanically isolated and is also used for the fan supply. As the internal transformer is not sized to supply other loads, another external isolated 220 V source is required to control the main contactor.
- ☑ In case of a complete unit, the external auxiliary pre-charge contactor must be fitted with a NC-contact for commanding the internal pre-charge contactor, a NO contact to command the main contactor and a NC-contact for commanding the pre-charge contactor internal to the CFW-09 HD.

Terminal	XC1	Factory Default Function	Specifications
1	DI1	General enabling	2 isolated digital inputs Min. high level: 18 Vdc Min. low level: 3 Vdc Max. voltage: 30 Vdc Input current: 11mA @ 24Vcc
2	DI2	Without external error	
3	-	Not used	
4	-	Not used	
5	-	Not used	
6	-	Not used	
7	COM	Digital common input	
8	COM	Digital common input	
9	24Vcc	Digital Input supply	24 Vdc ± 5%, Capacity: 2 mA
10	DGND*	0 V reference of the 24 Vdc source	Grounded through a 249 Ω resistor
11	-	Not used	Signals coming from the CSR2 board
12	AI1+	VAB synchronism input	
13	AI1-	Synchronism Off-Set Input	
14	- REF	Synchronism Off-Set	
15	AI2+	VCA synchronism input	
16	AI2-	Synchronism Offset input	
17	AO1	Analog Output 1: Power input	0 to + 10V, $R_L \geq 10k\Omega$ (max. load) resolution: 11bits
18	DGND	0 V Reference for the Analog Output	Grounded via 5.1Ω resistor
19	AO2	Analog Output 2: input current	0 to + 10V, $R_L \geq 10k\Omega$ (max. load) resolution: 11bits
20	DGND	0 V Reference for the analog output	Grounded via 5,1Ω resistor
Terminal	XC1A	Factory Default function	Specifications
21	RL1 NF	Command for Auxiliary pre-charge Contactor	Contact capacity: 1A 240VAC
22	RL1 NA	Command of the main contactor	
23	RL2 NA	Relay output - No fault	
24	RL1 C	Contactor Command	
25	RL2 C	Relay Output - N>Nx	
26	RL2 NF		
27	RL3 NA	Relay Output - N>Nx	
28	RL3 C		

Note: NC = Normally Closed contact, NO = Normally Open contact, C = Common

Figure 2.2 - Description of the XC1/XC1A terminal (CC9 board)

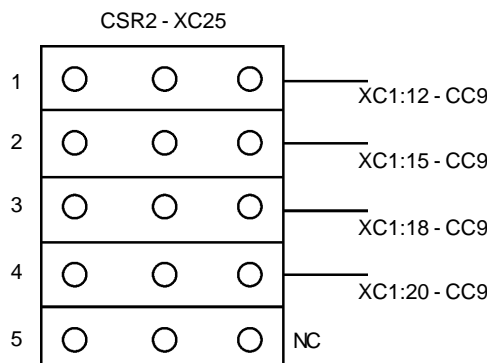

Figure 2.3 - Details of the Synchronism connection between the CSR2 and the CC9 board

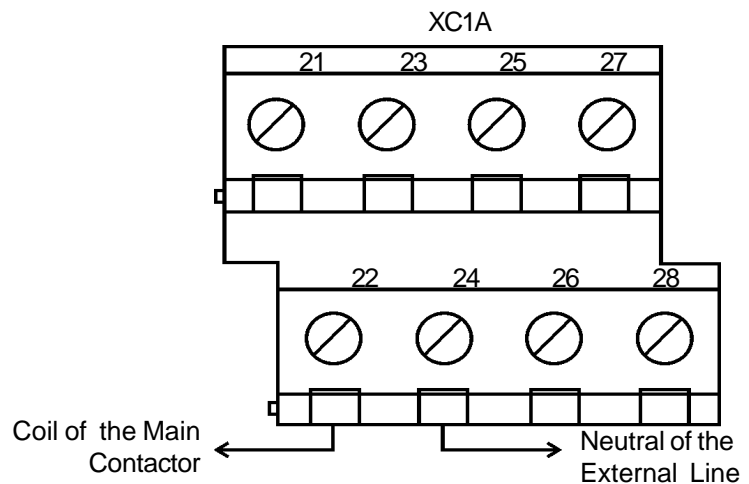

Figure 2.4 - Connection of the pre-charge commands (XC1A terminal of the CC9 board)

- ☑ An important detail to be noted is the connection of the No Fault Relay Output at one of the digital inputs of the inverter output. The function of this connection is to avoid that the inverter operates only when the CFW-09RB is not operating correctly and not regulating the DC Link.
- ☑ It is very important that during the power-up process a time-delayed relay is in the CFW-09 RB enabling string. This relay must be commanded through an auxiliary contact of the main contactor. This relays has the function to delay the CFW-0 RB enabling sufficiently, so no network disturb caused by the closing of the main contactor affects the synchronization signal. If this happens, the wrong fault message E00 may be displayed.

2.1 EUROPEAN EMC DIRECTIVE

CFW-09RB should be used in industrial networks - second enviroment - according to the standard EN61800-3: EMC Product Standard for Power Driver Systems.

It can cause inteference when used in public low voltage networks
The EMC filters specified in Item 3.3 of the CFW-09 Inverter Manual do not apply to the CFW-09RB.

START-UP

This Section provides following information:

- ☑ How to check and prepare the rectifier before powering-up;
- ☑ How to check power-up and how to check for proper operation;
- ☑ How to operate the rectifier when installed according to typical drivings (see Electrical Installation).

3.1 PRE-POWER CHECKS

The rectifier should be already installed according to Chapter 2: Electrical Installation. If the driving design is different from the suggested typical drivings, follow following steps.



DANGER!

Disconnect the AC input power before making any connection.

1) Check all connections

Check if the power, grounding and control connections are correct and well tightened.

2) Clean the inside of the rectifier

Remove all shipping material from the inside of the rectifier or cabinet.

3) Check if the selected inverter AC power is correct (Refer to Section 3.2.3)

4) Check the inductor

Check all inductor connections and verify if its voltage, current and frequency match the rectifier specifications.

6) Close the inverter cover or cabinet doors

3.2 INITIAL POWER-UP (required parameter settings)

After pre-power checks have been made, AC power can be applied:

1) Check the supply voltage

Measure the line voltage and check if it is within the specified range (Rated Voltage + 10% / - 15%).







2) Power-up the AC input

Close the input circuit breaker.

3) Check if the power-up has been successful

When the rectifier is powered up for the first time or when the factory default parameter values are loaded (P204 = 5), programming routine of the language is started.

Start-up - Programming via Keypad (HMI)

ACTION	DISPLAY HMI LED DISPLAY HMI LCD	DESCRIPTION
After power-up, the display shows following message		Language Selection: 0=Portuguese 1=English 2=Spanish
Use the keys  and  to select the language		Selected language: Portuguese (already selected value is maintained)
Press  to save the selected option and exit the programming mode		Exit the programming mode.



NOTES!

- To repeat the initial power-up procedures:
Set parameter P204 = 5 (this loads the factory default parameters) and then follow the initial power-up routine;



DANGER

Many components may be charged with high voltages, even after the incoming AC power supply has been switched Off. Wait at least 10 minutes for the total discharge of the power capacitors.

- Rectifier must be already installed according to Chapter 2 - Electrical Installation.
- User should read Chapter 4 and 5 to become familiarized with the HMI and to learn about the parameter organization.



After powering-up, rectifier starts automatically operation. When disabled, rectifier operates as a conventional diode bridge. This last operation mode should not be used.

Settings during Start-up

Although the factory default settings had been selected to meet the most applications, the setting of some parameters could be required during the start-up.

Check the table of the Quick Parameter Reference if parameter settings are required. Set the parameters according to the specific application and record the last value in the corresponding column of the User's Setting. This information may be helpful for future checks.

KEYPAD (HMI) OPERATION

This Chapter describes the standard Human-Machine-Interface (HMI), of the rectifier and its operation mode providing the following information:

- ☑ General Keypad Description;
- ☑ Use of the Keypad;
- ☑ Rectifier Parameter Organization;
- ☑ Parameter Programming mode;
- ☑ Description of the status displays and signalings.

4.1 DESCRIPTION OF THE KEYPAD HMI-CFW09-LCD

The standard CFW-09RB Keypad has a 4 digit, seven-segment display and an LCD display with two lines of 16 alphanumeric characters. There are also 4 indicator LED's and 8 keys.

Figure 4.1 shows the front view of the Keypad and indicates the position of the displays and status LED's.

Functions of the LED Display:

The LED Display shows the fault codes and status (see Quick Parameter Reference, Fault and Status Messages. The LED display at the right side indicates the unit of the variable:

- : A → current (Amps)
- . U → voltage (Volts)
- H → frequency (Hertz)
- Blank → speed and other parameters



When the value is equal to or higher than 1000 (Amps or Volts), the variable unit will not be shown (ex.: 568.U, 999.A, 1000., 1023., etc.)

Functions of the LCD Display:

The LCD Display shows the parameter number and its value simultaneously, without requiring the toggling of the  key. It also provides a brief description of each parameter function, indicating the respective units (A, Hz, V, s, %, etc.). It also provide a brief description of the rectifier error or status.

LOCAL and REMOTE LED's

Rectifier always in Local Mode:
Green LED ON and Red LED OFF.

Direction of Rotation (FWD / REV) LED's:

It indicates if the rectifier is motorizing (red LED ON) or regenerating (green LED ON). See Fig. 4.1.

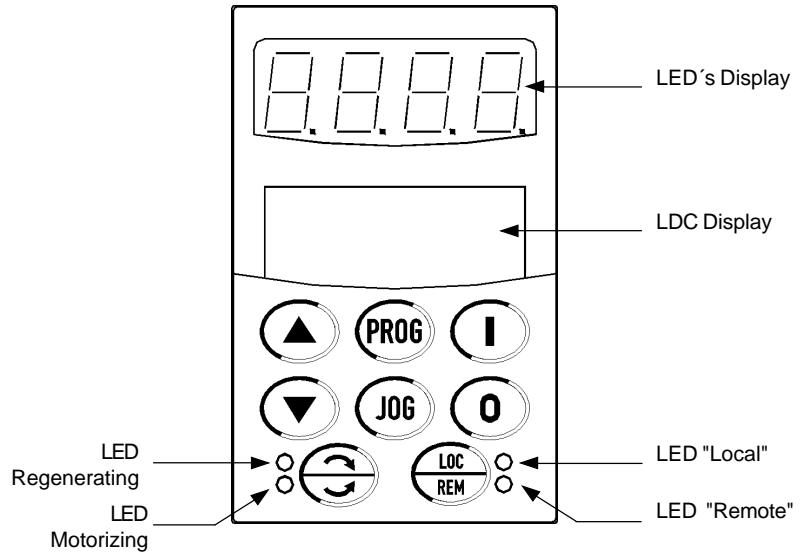
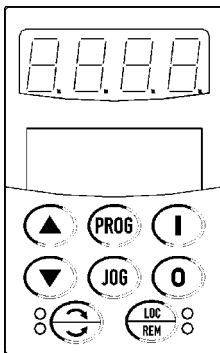









Figure 4.1 - HMI-CFW09-LCD



Basic Functions of the Keys:



-  Not used.
-  Resets the inverter after fault status.
-  Selects (toggles) display between the parameter number and its value (position/content).
-  Increases the number or the value of the parameter.
-  Decreases the number or the value of the parameter.
-  Not used.
-  Not used.
-  Not used.

4.2 USE OF THE KEYPAD (HMI)

The keypad (HMI) is used for programming and operating of the rectifier, allowing the following functions:

- Indication of the rectifier operation status and the main operation variables;
- Fault indications;
- Viewing and programming of the setable parameters;
- Operation of the rectifier (key ) and parameter programming (keys  and ).

4.2.1 Use of the Keypad (HMI)

All functions relating to the rectifier operation can be executed through the HMI.

Description of the Keypad Keys for the Rectifier Operation:

All functions relating to the rectifier operation can be executed through the HMI.

These functions can also be executed jointly or individually by means of digital and analog inputs. Thus program the parameter related to these functions and to these corresponding inputs.

Please find below description of the HMI Keypad keys used for the rectifier operation:



Not used.



Not used.



“0”: It resets the reCtifier after a fault trip (Always active).



Not used.



Not used.



When pressed, it increases the parameter number or its content.



When pressed, it decreases the parameter number or its content.

**4.2.2 Signallings/
Indications on the HMI
Displays**

a) Monitoring variables:

The monitoring variable to be shown after AC power is applied to the rectifier is defined in Parameter P205:

P205	Initial Monitoring Parameter
0	P002 (Line voltage)
1	P003 (Input current)
2	P004 (DC voltage)
3	P006 (Rectifier voltage)
4	P010 (Input power)
5	P042 (hours energized)
6	P043 (hours enabled)

b) Rectifier status:



Inverter is READY to be started

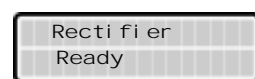

Inverter is enabled ('Run')

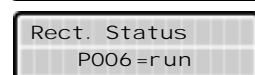



Line voltage is too low for inverter operation (Undervoltage condition)



c) LED display flashes:
The display flashes in the following conditions:

- trying to change a parameter value when this is not permitted.
- rectifier in overload condition (refer to chapter - Maintenance)
- Rectifier in Fault condition (refer to chapter - Maintenance)

4.3 PARAMETER PROGRAMMING

All RECTIFIER settings are made through the parameters. The parameters are shown on the display with the letter **P** followed by a number:
Example (P151):



151 = Parameter number

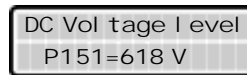









Each parameter is associated to a numerical value (parameter content).

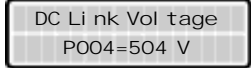

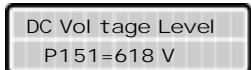

The parameter values define the rectifier programming or the variable value (ex.: current, frequency, voltage).

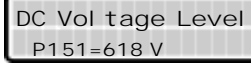
For rectifier programming, parameter (s) content(s) must be changed.

4.3.1 Parameter Selection/Programmin:

ACTION	DISPLAY HMI LED DISPLAY HMI LCD	Comments
Press the key 	 	
Use the keys  and 	 	Selects the desired parameter
Press the key 	 	Numeric value associated to the parameter

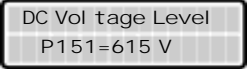
KEYPAD (HMI) OPERATION

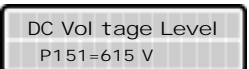
ACTION	DISPLAY HMI LED DISPLAY HMI LCD	Comments
Use the keys  and 	 	Sets the new desired value *1
Press the key 	 	*1, *2, *3

*1 - For parameters that can be changed with enabled rectifier, the rectifier will use the new value immediately after it has been set. For the parameters that can be changed only with rectifier disabled, the rectifier will use this new set value only after the  key is pressed.

*2 - By pressing the key  after the reprogramming, the last set value will be stored automatically in the non-volatile memory until a new value is programmed.

*3 - To allow the reprogramming of any parameter value it is required to change parameter P000 to the password value. The factory default password value is 5. Otherwise you can only read the parameter values and not reprogram them.

For more details see P000 description in Chapter 5.

DETAILED PARAMETER DESCRIPTION

This Chapter describes in detail all rectifier parameters. In order to simplify the explanation, the parameters have been grouped by characteristics and functions:

Read Only Parameters	Variables that can only be viewed on the display but can not be not changed by the user.
Regulation Parameters	Programmable values to be used by the rectifier functions.
Configuration Parameters	They define the rectifier characteristics, the functions to be executed, as well as the input/output functions of the control board.



Symbols and definitions used in the text below:

'(1)' indicates that the parameter can be changed only with the rectifier disabled.

5.1 ACCESS AND READ ONLY PARAMETERS - P000....P099

Parameter	Range [Factory Setting] Unit	Description/Notes
P000 Access Parameter/ Password value Setting	0...999 [0] -	<input checked="" type="checkbox"/> This parameter releases the access to change the parameter content. With the factory default password is [P200= 1 (Password active)] you must set P000=5 to change the parameter contents, i. e., the password value is equal to 5.
P002 Line Voltage	0 ... 600 [-] 1V	<input checked="" type="checkbox"/> Indicates the input line voltage in Volts
P003 Input Current	0...2600 A [-] 0,1A (<100)-1A (>99,9)	<input checked="" type="checkbox"/> Indicates the rectifier input current in Amps.
P004 DC Link Voltage	0...1077 [-] 1V	<input checked="" type="checkbox"/> Indicates the DC Link voltage in Volts.
P006 Rectifier Status	Rdy, run, sub, Exy	<input checked="" type="checkbox"/> Indicates the rectifier status: 'rdy' rectifier is ready to be started or enabled; 'run' rectifier is enabled; 'Sub' rectifier is disabled and line voltage is too low for operation (undervoltage). It does not receive enabling controls; 'Exy' inverter is in a fault condition, 'xy' is the number of the Fault code
P010 Input Power	0.0...1200 kW [-] 0,1kW	<input checked="" type="checkbox"/> Indicates the instantaneous input power in kW.

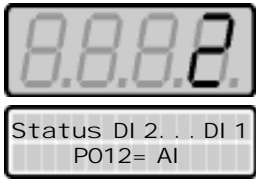
DETAILED PARAMETER DESCRIPTION

Parameter	Range [Factory Setting] Unit	Description/Notes
P012 Status DI1...DI2	LCD= A, I LED= 0 ... 255 [-] -	<p><input checked="" type="checkbox"/> Indicates on the Keypad LCD display the status of the 2 digital inputs of the control board (DI1 to DI2). Letter A stands for Active and letter I stands for Inactive in the following order: DI2, DI1</p> <p><input checked="" type="checkbox"/> The LED display of the HMI Keypad shows a decimal value related to the 2 Digital Inputs, where the status of each input is considered one bit in the specified sequence: Active = 1, Inactive = 0 and the DI2 status is the most significant bit (MSB). Example: DI2=Active (+24V); DI1=Inactive (0V) This is equivalent to the bit sequence: 10 which corresponds to the decimal number 2. Thus the keypad displays will be as follows:</p> 
P013 Digital and Relay Outputs DO1, DO2 RL1, RL2 and RL3 Status	LCD = A, I LED = 0...255 [-] -	<p><input checked="" type="checkbox"/> Indicates on the Keypad LCD Display the status of the 2 Digital Outputs of the I/O Expansion Board (D01, D02) and the 3 Relay Outputs of the control board. Letter A stands for Active and letter I stands for Inactive, in the following order: D01, D02, RL1, RL2, RL3.</p> <p><input checked="" type="checkbox"/> The LED display shows a decimal value related to the status of the 5 Digital Outputs, where the status of each output is considered one bit of a binary number where Active = 1, Inactive = 0 and the status of DO1 is the most significant bit (MSB). The 3 least significant bits are always '0'. Example: DO1=Inactive; DO2=Inactive RL1=Active; RL2=Inactive; RL3=active This is equivalent to the binary sequence: 00101000 Which corresponds to the decimal number 40. The Keypad displays will be:</p> 
P014 Last Fault	E00...E41 [-] -	<input checked="" type="checkbox"/> Indicate the code of the last, second, third and fourth previous Faults. Fault Sequence:
P015 Second Previous Fault	E00...E41 [-] -	<input checked="" type="checkbox"/> Systematic record Exy → P014 → P015 → P016 → P017
P016 Third Previous Fault	E00...E41 [-] -	
P017 Fourth Previous Fault	E00...E41 [-] -	

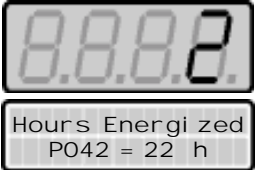
Parameter	Range [Factory Setting] Unit	Description/Notes
P022 WEG Use	- [-] -	
P023 Software Version	XXX [-] -	☑ Indicates the Software version stored in the microcontroller memory configured on the control board.
P024 A/D Conversion Value of the Analog Input AI4	LCD: -32768...32767 LED: 0...FFFFH [-] -	☑ Indicates the A/D conversion result of the analog input A14 located on the I/O Expansion Board. ☑ The LCD display indicates the conversion value as a decimal number and the LED display as a hexadecimal number with negative values in supplement of 2.
P025 A/D Conversion Value of Iv Current	0...1023 [-] -	☑ P025 and P026 indicate the A/D conversion result, in module, of the V and W phase currents, respectively.
P026 A/D Conversion Value of Iw Current	0...1023 [-] -	
P027 WEG Use	- [-] -	
P028 WEG Use	- [-] -	
P029 WEG Use	- [-] -	
P042 Time Powered	LCD: 0...65530h LED: 0...6553h (x10) [-] -	☑ Indicates the total number of hours that the rectifier was powered. ☑ The LED Display shows the total number of hours that the rectifier was energized divided by 10. ☑ This value remains stored even when the rectifier is turned OFF. Example: Indication of 22 hours powered.
		
P043 Time Enabled	0...6553h [-] -	☑ Indicates the total number of hours that the rectifier was enabled. ☑ Indicates up to 6553 hours, rolls over to 0000. ☑ If P204=3 is set to 3, the Parameter P043 is reset to zero. ☑ This value remains stored even when the rectifier is turned OFF.
P121 Reactive Current Reference	-100%...100% [0.0] 1%	☑ The value of P121 is the reactive current reference. If negative, the input current will be advanced relating to the voltage (capacitive). If positive, the input current will be delayed relating to the voltage (inductive). ☑ If maintained at zero, the current will be in phase with the voltage. The standard factory setting is P121=0. This setting ensures a power factor near to zero at the rectifier input. Do not change this value before contacting WEG Automação.

5.2 REGULATION PARAMETERS - P100P199

Parameter	Range [Factory Setting] Unit	Description/Notes
P151 DC Voltage Level	322V... 394V (P296=0) [358V] 1V	<input checked="" type="checkbox"/> The standard value of this parameters changes with P296.
	556V...680V (P296=1) [618V] 1V	
	585V...715V (P296=2) [650V] 1V	
	646V...790V (P296=3) [718V] 1V	
	675V...825V (P296=4) [750V] 1V	
P156 Overload Current	0- ... 1.3xP295 [1.1x 295] 0,1A(<100) - 1A(>99.9)	<input checked="" type="checkbox"/> Used for protection against overload (Ixt - E05). <input checked="" type="checkbox"/> The Overload Current (P156, P157 and P158) is the current level above which the rectifier will consider the inductor operating under overload. The higher the difference between the inductor current and the overload current, the sooner the Overload Fault E05 will occur. <input checked="" type="checkbox"/> The Parameter P156 (overload current) must be set 10% higher than the used rated rectifier current (P295).
P161 Proportional DC Gain	0.0...63.9 [5.0] -	<input checked="" type="checkbox"/> The standard values of the gains of P161 and P162 meet the most cases and do not require any setting. <input checked="" type="checkbox"/> By increasing the P161 gain, we will have a faster DC Link regulation with less increase.

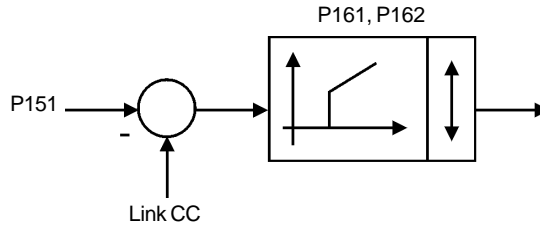

Figure 5.1 - Block Diagram of the DC Link Voltage

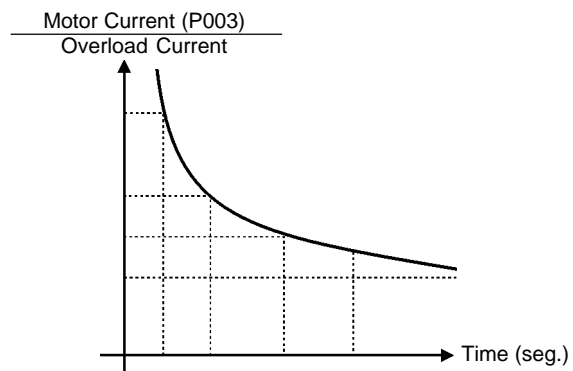

Figure 5.2 - Ixt Function - Overload detection

Parameter	Range [Factory Setting] Unit	Description/Notes
P162 DC Proportional Gain	0.000...9.999 [0.009] -	<ul style="list-style-type: none"> ☑ By increasing the P162 gain, we will have a better DC Link regulation with faster response, increasing the overshoot during enabling, which may cause overcurrent in this condition. ☑ Figure 5.3a shows the effect by increasing P162, thus changing the DC Link voltage level during enabling. According to P162, the voltage increase tends to exceed the rated value, thus causing an overcurrent. ☑ Figure 5.3b shows the effect of the proportional gain by changing the DC Link voltage level during enabling. The increase of the proportional gain causes a faster response time. A too high proportional gain can cause an overcurrent. ☑ Figure 5.3c shows what happens with the DC Link voltage, when the load increases suddenly, and the proportional gain changes. Increasing the proportional gain, will has a faster response and less undershoot voltage. A too low gain may cause undervoltage in the DC link circuit. ☑ Figure 5.3d shows the effect on the DC link voltage when a load is applied on the rectifier and the integral gain is varied. By increasing the integral gain will cause a faster recover of the DC link voltage. ☑ A higher P162 Parameter will decrease the error between the DC link voltage and the reference (P151). ☑ It is recommended to vary the gains proportionally. Thus when P161 is increased also increase P162 proportionally. The same procedures should be adopted when the gains are reduced.

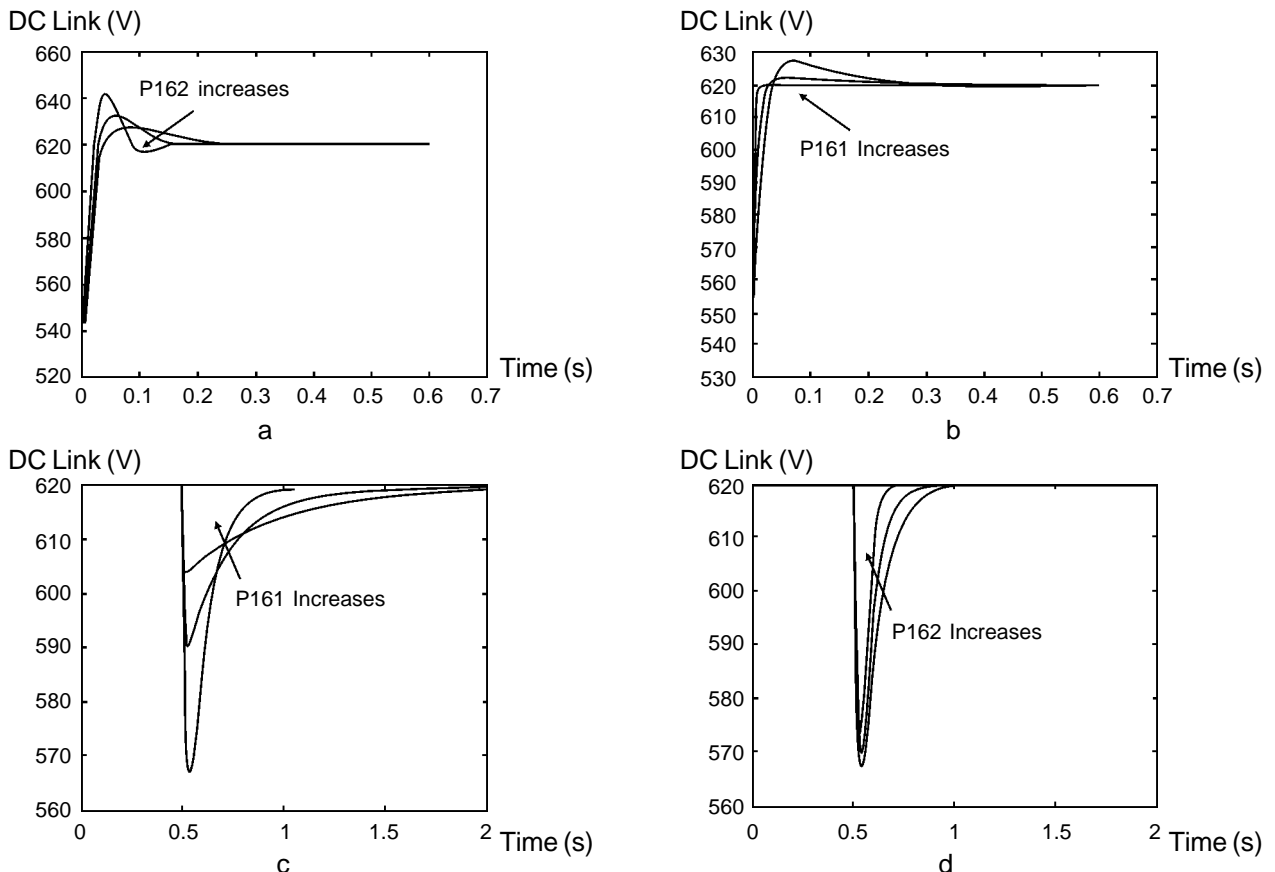

Figure 5.3 - Effect of the Gain Change



DETAILED PARAMETER DESCRIPTION

Parameter	Range [Factory Setting] Unit	Description/Notes
P167 Current Regulator Proportional Gain	0.00... 1.99 [0.7] -	<input checked="" type="checkbox"/> The gains of P167 and P168 are already set. User shall maintain the standard values. <input checked="" type="checkbox"/> If the standard inductance is used that is supplied with the product, please change these gains.
P168 Current Regulator Integral Gain	0.000... 1.999 [0.250] -	
P169 Max. Braking Current	0 ... 150% [100%] 1%	<input checked="" type="checkbox"/> It limits the maximum line current in the braking condition (energy is returned to the line) <input checked="" type="checkbox"/> In this condition the current has a 180° offset relating the input current.
P170 Max. Motorizing Current	0 ... 150% [100%] 1%	<input checked="" type="checkbox"/> It limits the maximum line current in the motorizing condition (line energy absorption). <input checked="" type="checkbox"/> The motorizing current is the current that flows from the line to the DC Link. <input checked="" type="checkbox"/> In this condition the current will be in phase with the input voltage.
P175 Proportional Gain of the Reactive Regulator	0.0...31.9 [3.3] -	<input checked="" type="checkbox"/> The gains of P175 and P176 are already set. User shall maintain the standard values.
P176 Integral Gain of the Reactive Regulator	0.000... 9.999 [0.067] -	
P179 Maximum Reactive	0...120% [120%] 1%	<input checked="" type="checkbox"/> Parameters P179 and P180 are associated to the reactive generation by the rectifier. When the line voltage exceeds percentually the value set at P180 (the rated voltage of the rectifier corresponds to 100%), the rectifier starts to inject reactives. The reactive injection ensures that the DC Link voltage remains at the value set at P151. The reactive injection is the offset of the input current relating to the voltage and the current will be delayed by 90° (inductive). These parameters are useful for minimizing the line transient effects that could cause overvoltages. The voltage "excess" is transferred to the input reactance.
P180 Point of Reactive Generation	0...120% [120%] 1%	

5.3 CONFIGURATION PARAMETERS - P200P399

P200 Password (activates/deactivates the password)	0...1 [1] -	P200	Result
		0 (Off)	It permits to change the parameters content independently of P000
1 (On)	It permits only to change the parameters content when P000 is equal to the value of the password.		

With factory setting, the password is P000=5.
 To change the password, see P000.

Parameter	Range [Factory Setting] Unit	Description/Notes								
P201 Language Selection	0...2 [to be defined by the user] -	0=Portuguese 1=English 2=Spanish								
P204 Loads / Saves Parameters (1)	0...11 [0] -	<p><input checked="" type="checkbox"/> The parameters P295 (Rated Current) and P296 (Rated Voltage), P297 (Switching Frequency) are not changed when the factory default parameters are loaded through P204 = 5.</p> <div style="text-align: center;">  <pre> graph LR A[Factory Default (WEG standard)] -- P204 = 5 --> B[Current Inverter Parameters] </pre> </div> <p>Figure 5.4 – Parameter Transfer</p> <table border="1" style="margin-left: auto; margin-right: auto;"> <thead> <tr> <th></th> <th>P204 Action</th> </tr> </thead> <tbody> <tr> <td>0, 1, 2, 4, 6, 9</td> <td>Not Used: No action</td> </tr> <tr> <td>3</td> <td>Reset P043: Resets the Time Enabled hour meter to zero.</td> </tr> <tr> <td>5</td> <td>Load WEG: Resets all parameters to the factory default values.</td> </tr> </tbody> </table> <p><input checked="" type="checkbox"/> NOTE! The parameter load/save action will be effected only after the parameters have been set and key  is pressed.</p>		P204 Action	0, 1, 2, 4, 6, 9	Not Used: No action	3	Reset P043: Resets the Time Enabled hour meter to zero.	5	Load WEG: Resets all parameters to the factory default values.
	P204 Action									
0, 1, 2, 4, 6, 9	Not Used: No action									
3	Reset P043: Resets the Time Enabled hour meter to zero.									
5	Load WEG: Resets all parameters to the factory default values.									
P205 Selection of the indicated Read Parameter	0...6 [2] -	<p><input checked="" type="checkbox"/> Selects which of the read parameters listed below will be shown on the display, after the rectifier is powered up:</p> <ul style="list-style-type: none"> 0=P002 (line Voltage) 1=P003 (Input Current) 2=P004 (DC Link Voltage) 3=P006 (Rectifier Status) 4=P010 (Input Power) 5=P042 (Time ON) 6=P043 (Time enabled) 								
P206 Auto-Reset Time	0...255 [0] 1s	<p><input checked="" type="checkbox"/> In the event of a fault trip, except when E09, E31 or E41, the rectifier can initiate an automatic reset after the time given by P206 is elapsed.</p> <p><input checked="" type="checkbox"/> If P206 ≤ 2 Auto-Reset does not occur.</p> <p><input checked="" type="checkbox"/> If after Auto-Reset the same fault is repeated three times consecutively, the Auto-Reset function will be disabled. A fault is considered consecutive if it happens again within 30 seconds after Auto-Reset. Thus if a fault occurs four times consecutive, this fault will be displayed permanently (and the rectifier will be disabled).</p>								
P218 LCD Display Contrast Adjustment	0 ... 150 [127]	<p><input checked="" type="checkbox"/> This parameter is useful only for rectifiers provided with a keypad (HMI) with LCD display.</p> <p><input checked="" type="checkbox"/> It allows the adjustment of the LCD Display contrast to obtain a better visualization.</p>								

DETAILED PARAMETER DESCRIPTION

Parameter	Range [Factory Setting] Unit	Description/Notes
P251 A01 Output Function	0 ... 3 [0] -	<input checked="" type="checkbox"/> Check in Table 5.1 all possible options.
P252 A01 Output Gian	0.000 ... 9.999 [1.000] 0.001	
P253 A02 Output Function	0 ... 3 [0] -	<input checked="" type="checkbox"/> Check in Table 5.1 all possible options.
P254 A02 Output Gain	0.000 ... 9.999 [1.000] 0.001	
P255 A03 Ouput Function (located on the optional EBA board)	0 ... 25 [0] -	<input checked="" type="checkbox"/> Check in Table 5.1 all possible options. For more information about the AO3 output, check items 8.1.1 and 8.1.3 of the CFW-09 Frequency Inverter Manual.
P256 A03 Output Gain	0.000 ... 9.999 [1.000] 0.001	
P257 A04 Ouput Function (located on the optional EBA board)	0 ... 25 [0] -	<input checked="" type="checkbox"/> Check in Table 5.1 all possible options. For more information about the AO3 output, check items 8.1.1 and 8.1.3 of the CFW-09 Frequency Inverter Manual.
P258 A04 Output Gain	0.000 ... 9.999 [1.000] 0.001	

	Line Voltage	Input Current	DC Lin Voltage	Input Power	Exclusive use of WEG
P251 (AO1)	0	1	2	3	-
P253 (AO2)	0	1	2	3	-
P255 (AO3)	0	1	2	3	4...25
P257 (AO4)	0	1	2	3	4...25

Table 5.1 - Functions of the Analog Outputs

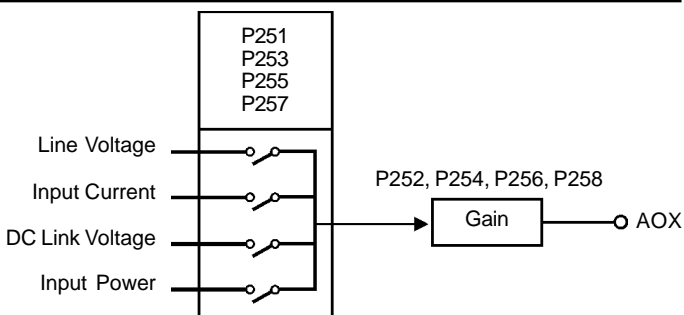
Parameter	Range [Factory Setting] Unit	Description/Notes
		 <p>Figure 5.5 - Block diagram of the Analog Outputs</p> <p> <input checked="" type="checkbox"/> Scale of the Analog Outputs indications: - Full scale = 10V: Line Voltage: full scale = 1,4 x P296 Input Current: full scale = 1,6 x P295 DC Link Voltage: full scale = $\sqrt{2}$ x P296 Input Power: full scale = $2,04 \times \sqrt{3} \phi$ P295 x P296 </p>
P263 DI1 Digital Input Function	2...2 [2 (Gen. enabling)] -	<input checked="" type="checkbox"/> The status of the digital inputs can be monitored at parameter P012.
P264 DI2 Digital INput Function	4...4 [4 (without ext. fault)] -	

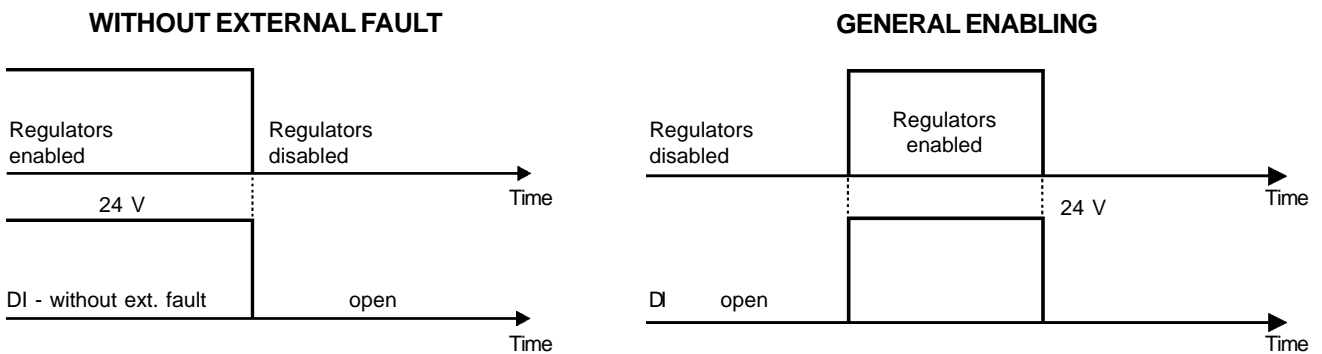
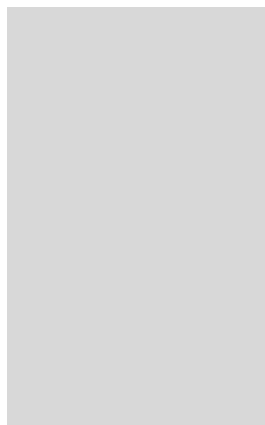

Figure 5.6 - Details about the operation of the Digital Inputs Functions



DETAILED PARAMETER DESCRIPTION

Parameter	Range [Factory Setting] Unit	Description/Notes
P275 DO1 Digital Output Function (located on the opt. expansion board) (1)	0...26 [0 (Not used)] -	<input checked="" type="checkbox"/> Check possible options on Table 5.3 and details about each function's operation on Figure 5.7. <input checked="" type="checkbox"/> The status of the Digital Outputs can be monitored at Parameter P013. <input checked="" type="checkbox"/> The Digital Output will be activated when the condition stated by its function becomes true, i.e. DOx = transistor saturated and/or RLx = relay with energized coil.
P276 DO2 Digital Output Function (located on the opt. expansion board) (1)	0...26 [0 (Not used)] -	<input checked="" type="checkbox"/> Additional Notes about the Digital Output Functions: -'Run' rectifier is disabled. -'Ready' rectifier is enabled. -'No Fault' rectifier is not in any fault condition. -'Fault' rectifier is disabled due to any fault condition. -'No E00' rectifier is disabled due to E00 fault condition. -'No E00+E02+E03N' rectifier is not disabled due to E01 or E02 or E03 fault condition. -'No E04' rectifier is disabled due to E04 fault condition. -'No E05' rectifier is disabled due to E05 fault condition. -'Not used' Digital Outputs remains always inactive, i.e., DOx=transistor cut and RLx=r relay with energized coil. -'Preload OK' the voltage in the DC Link circuit is higher than the preload voltage level.
P277 RL1 Relay Output Function- (1)	24...24 [24 (Preload OK)]	
P279 RL2 Relay Output Function (1)	0...26 [13 (No Fault)] -	
P280 RL3 Relay Output Function (1)	0...26 [11 (Run)] -	

Parameter	Range [Factory Setting] Unit	Description/Notes					
		Parameter Function	P275 (DO1)	P276 (DO2)	P277 (RL1)	P279 (RL2)	P280 (RL3)
		Not used	0	0	24	0	0
		Not used	1	1	24	1	1
		Not used	2	2	24	2	2
		Not used	3	3	24	3	3
		Not used	4	4	24	4	4
		Not used	5	5	24	5	5
		Not used	6	6	24	6	6
		Not used	7	7	24	7	7
		Not used	8	8	24	8	8
		Not used	9	9	24	9	9
		Not used	10	10	24	10	10
		run	11	11	24	11	11
		ready	12	12	24	12	12
		No Fault	13	13	24	13	13
		No E00	14	14	24	14	14
		No E01+E02+E03	15	15	24	15	15
		No E04	16	16	24	16	16
		No E05	17	17	24	17	17
		Not used	18	18	24	18	18
		Not used	19	19	24	19	19
		Not used	20	20	24	20	20
		Not used	21	21	24	21	21
		Not used	22	22	24	22	22
		Not used	23	23	24	23	23
		Preload OK	24	24	24	24	24
		No Fault	25	25	24	25	25
		Not used	26	26	24	26	26

Table 5.3 - Functions of the Digital Outputs

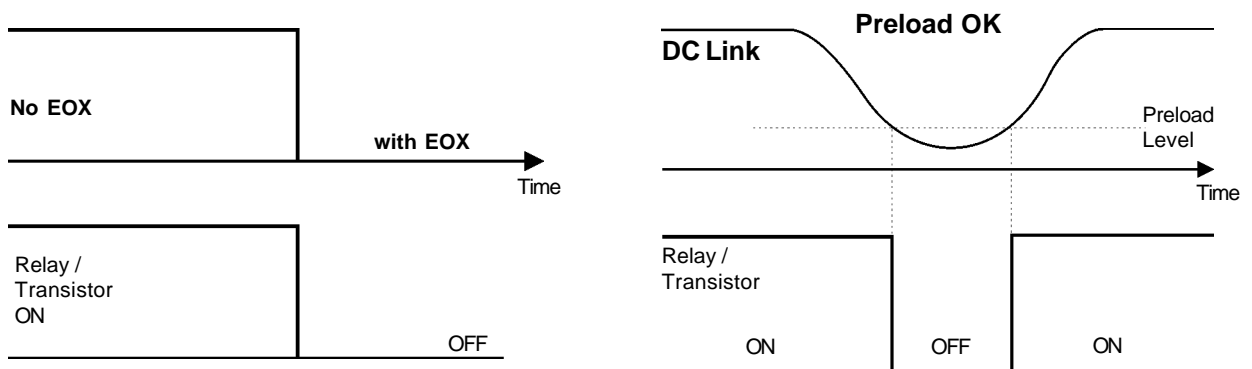

Figure 5.7 - Details about the operation of the Digital Output Functions

P295 Rectifier rated current (1)	17 ... 25 [According to Rectifier rated current] -	17=86.0A; 18=105.0A; 19=130.0A; 20=142.0A; 21=180.0A; 21=205.0A; 22=240.0A; 23=300.0A; 24=350.0A; 23=361.0A; 26=400.0A; 24=450.0A; 28=580.0A; 25=600.0A; 26=400.0A; 24=450.0A; 28=580.0A; 25=600.0A; 26=650.0A; 27=810.0A; 28=1080.0A; 29=1215.0A; 30=1620.0A.
--	--	--

DETAILED PARAMETER DESCRIPTION

Parameter	Range [Factory Setting] Unit	Description/Notes
P296 Rated Voltage (1)	0...4 [According to Rectifier Supply Voltage] -	0=220V/230V 1=380V 2=400V/415V 3=440V/460V 4=480V <input checked="" type="checkbox"/> For rectifiers with rated current (86A and rated voltage from 380V to 480V, adjust also the voltage selection jumper (Refer to the CFW-09 Inverter Manual).
P297 Switching Frequency (1)	1...2 [2 (5.0 kHz)] -	1=2.5 kHz 2=5.0 kHz <input checked="" type="checkbox"/> For the models 180 ... 600S, used the switching frequency of 2.5kHz. <input checked="" type="checkbox"/> The switching frequency is a compromise between the motor acoustic noise level and the inverter IGBTs losses. Higher switching frequencies cause lower motor acoustic noise level, but increase the IGBTs losses, increasing drive components temperature, thus reducing their useful life. The predominant frequency on the motor is twice the switching frequency programmed at P297. P297 = 5.0 kHz results in an audible motor noise corresponding to 10.0 kHz. This is due to the PWM technique used. A reduction of the switching frequency also: - Helps reducing instability and resonance problems that may occur in certain application conditions. - Reduces the leakage currents to ground, which may avoid nuisance of E11 (short-circuit between phase-earth at the output).

DIAGNOSTICS AND TROUBLESHOOTING

This Chapter assists the user to identify and correct possible faults that can occur during the operation. Guidance on Preventive Maintenance is also provided.

6.1 FAULTS AND POSSIBLE CAUSES

When a fault is detected, the inverter is disabled and the Fault Code is displayed on the readout in the EXX form, where XX is the actual Fault Code.

To restart the inverter after a fault has occurred, the inverter must be reset. The reset can be made as follows:

- disconnecting and reapplying AC power (power-on reset);
- by pressing the key "0/RESET" (manual reset)
- automatic reset through P206 (auto-reset);

The table below defines each Fault Code, explains how to reset the fault and shows the possible causes for each Fault Code.

FAULT	RESET	POSSIBLE CAUSES
E00 Input Overcurrent	<input checked="" type="checkbox"/> Power-on <input checked="" type="checkbox"/> Manual (Key 0/RESET) <input checked="" type="checkbox"/> Autoreset	<input checked="" type="checkbox"/> Short-circuit between two input phases; <input checked="" type="checkbox"/> Inertia of the load is too high, or acceleration ramp is too short; <input checked="" type="checkbox"/> Transistor module is shorted; <input checked="" type="checkbox"/> Input reactance is not present; Regulation and/or configuration parameter(s) are incorrect. <input checked="" type="checkbox"/> P169, P170, P161, P162 set too high; <input checked="" type="checkbox"/> Wrong synchronism connections.
E01 DC Link Overvoltage (Ud)		<input checked="" type="checkbox"/> Power supply voltage too high, generating in the DC Link a voltage higher than permitted Ud>400V - Models 220-230V Ud>800V - Models 380- 480V <input checked="" type="checkbox"/> Inertia of the load is too high, or acceleration ramp is too high, or acceleration ramp is too short <input checked="" type="checkbox"/> P169 or P179 set too low.
E02 DC Link Undervoltage (Ud)		<input checked="" type="checkbox"/> Power supply voltage too low, generating in the DC Link a voltage lower than permitted (read value at Parameter P004): Ud < 223V - Models 220 - 230V Ud < 385V - Models 380V Ud < 405V - Models 400 - 415V Ud < 446V - Models 440 - 460V Ud < 487V - Models 480V <input checked="" type="checkbox"/> Phase loss at the input; <input checked="" type="checkbox"/> P169 set too low; <input checked="" type="checkbox"/> Pre-charge contactor defective; <input checked="" type="checkbox"/> Parameter P296 set to a voltage higher than the rated live voltage.

DIAGNOSTICS AND TROUBLESHOOTING

FAULT	RESET	POSSIBLE CAUSES
E03 Input Undervoltage/ Phase Loss (1)		<input checked="" type="checkbox"/> Power Supply voltage is too low Ualim < 154V for models 220-230V Ualim < 266V for models 380-480V <input checked="" type="checkbox"/> Phase loss at the inverter input. <input checked="" type="checkbox"/> Activation time: 2,0 seg
E04 Inverter Overtemperature or Pre-charge Circuit Defective (2) (3)		<input checked="" type="checkbox"/> Ambient temperature too high (>40°C) and/or output current too high; or ambient temperature <-10°C <input checked="" type="checkbox"/> Blowers locked or defective (3) Pre-charge circuit fuse blown (see Section 3.2.3); <input checked="" type="checkbox"/> The supply voltage is lower the min.a permitted value or phase loss, if they occur during more than 2 seconds and without phase loss detection.P214= 0 (disable).
E05 Inout Overload, IxT function(see P156)	<input checked="" type="checkbox"/> Power-on <input checked="" type="checkbox"/> Manual (tecla 0/RESET) <input checked="" type="checkbox"/> Autoreset	<input checked="" type="checkbox"/> P156 set too high for the used motor; <input checked="" type="checkbox"/> Load at motor shaft too high
E06 External fault (opening at dig. inout programmed to withoutpara fault)		<input checked="" type="checkbox"/> Wiring at DI1...DI2 inputs is open (not connected to a + 24V): <input checked="" type="checkbox"/> XC12 coonector on the CC(control board is not connected)
E08 CPU Error (watchdog)		<input checked="" type="checkbox"/> Electrical noise.
E09 Program Memory Error	Contact WEG (refer to Item 6.3)	<input checked="" type="checkbox"/> Memory with corrupted values.
E16 Line Overvoltage	<input checked="" type="checkbox"/> Power-on <input checked="" type="checkbox"/> Manual (key 0/RESET) <input checked="" type="checkbox"/> Autoreset	<input checked="" type="checkbox"/> Line Voltage oscillation higher than the permitteed one.
E31 Keypad (HMI) connection fault	It is automatically reset when HMI communication with inverter is reestablished	<input checked="" type="checkbox"/> Keypad (HMI) cable with bad contact <input checked="" type="checkbox"/> Electrical noise in the installation (eletromagnetic interferecen)
E41 Self-Diagnosis Fault	Contact WEG refer to Item 6.3)	<input checked="" type="checkbox"/> Memory error or any internal inverter circuit defective.

Note:

- 2) In case of E04 Fault due to inverter overtemperature, allow the inverter to cool before trying to reset it.
The failure in the pre-charge circuit means that the pre-charge contactor (sizes up to 142A) or pre-charge thyristor (sizes above 142A) is not closed, thus overheating the pre-charge resistors.
- (3) For 220-230V Models with rated current equal or higher than 105 A or 380-480V Models with rated current equal or higher than 86A, and equal or lower than 142A, E04 Fault can also be caused by internal airflow overtemperature. In this case, check the blower of the electronics.



NOTE!

Fault actuation form:

- ☑ E00,..., E08:
 - "No Fault" relay drops "out";
 - PWM pulses are stopped;
 - the LED indicates the Fault Code;
 - the LCD display indicates the fault code and description and the "Error" LED flashes.
 - The following data are stored in the EEPROM memory:
 - speed reference via Keypad or EP (Electronic Potentiometer; if the function "Reference Backup" at P120 is active;
 - number of the occurred error, displaces the last three errors);
 - The status of the Ixt Function (current overload);
 - the status of the hourmeter is enabled and powered up.
- ☑ E09: does not permit inverter operation (inverter can not be enabled).
- ☑ E41: does not permit inverter operation (inverter can not be enabled); The Fault Code is indicated on the LEDs display and the LCD display indicates the fault code and description and the "Error" LED flashes.
- ☑ E31: the inverter continues to operate normally; it does not accept the Keypad command; the fault code is indicated on the LED display and the LCD display indicates the fault code and description
- ☑ E03: if power is switched Off (line) with inverter at "General Disabling", it does not return to the memory of the last 4 errors.

Indication of the Inverter Status LED's:

Led Power	Led Error	Description
		Inverter is powered up and ready
	 (Flashing)	A fault has been detected. The FAULT LED flashes, indicating the number of the Fault Code. Exemple: Note: If Fault E00 occurs, the ERROR LED remains permanently ON

TECHNICAL SPECIFICATIONS

This Chapter describes the technical specifications (electrical and mechanical) of the CFW-09RB inverter series.

7.1 POWER DATA

AC Input Specifications:

- Voltage : + 10%, -15%;
- Frequency : 50/60Hz (± 2 Hz);
- Phase Unbalance ≤ 3%;
- Overvoltage Category III (EN 61010/UL 508C);
- Transient voltages according to Category III;

Power-up: 10 ON/OFF cycles per hour maximum.

7.1.1 220-230V Power Supply

Model: Current / voltage	105/ 220-230		130/ 220-230		180/ 220-230	240/ 220-230	361/ 220-230	450/ 220-230	600/ 220-230
	CT	VT	CT	VT	CT/VT	CT/VT	CT/VT	CT/VT	CT/VT
Load ⁽¹⁾									
Power (kVA) ⁽²⁾	40	50	50	62	69	91	138	171	229
Rated Input Current (A) ⁽³⁾	105	130	130	163	180	240	361	450	600
Maximum Input Current (A) ⁽⁴⁾	158		195		270	360	542	675	900
Switching Frequency (kHz)	5	2.5	5	2.5	2.5	2.5	2.5	2.5	2.5
DC Rated Current (A)	121	150	150	187	207	276	415	518	690
Rated Dissipated Power (kW)	1.2	1.5	1.5	1.7	3	4	6	7.6	10
Frame Size	6		6		8	8	9	10	10

Note: **CT** = Constant Torque
VT = Variable Torque

 Factory Default

7.1.2 380-480V Power Supply

Model: Current / Voltage	86/ 380-480		105/ 380-480		142/ 380-480		180/ 380-480	240/ 380-480	361/ 380-480	450/ 380-480	600/ 380-480
	CT	VT	CT	VT	CT	VT	CT/VT	CT/VT	CT/VT	CT/VT	CT/VT
Load ⁽¹⁾											
Power (kVA) ⁽²⁾	66	82	80	99	108	136	137	183	275	343	457
Rated Input Current (A) ⁽³⁾	86	108	105	130	142	178	180	240	361	450	600
Maximum Input Current (A) ⁽⁴⁾	129		158		213		270	360	542	675	900
Switching Frequency (kHz)	5	2.5	5	2.5	5	2.5	2.5	2.5	2.5	2.5	2.5
Rated DC Current (A)	99	124	121	150	163	205	207	276	415	518	690
Rated Dissipated Power (kW)	1.2	1.5	1.5	1.7	2.4	2.9	3	4	6	7.6	10
Frame Size	6		6		7		8	8	9	10	10

Note: **CT** = Constant Torque
VT = Variable Torque

 Factory Default



NOTES:
(1)

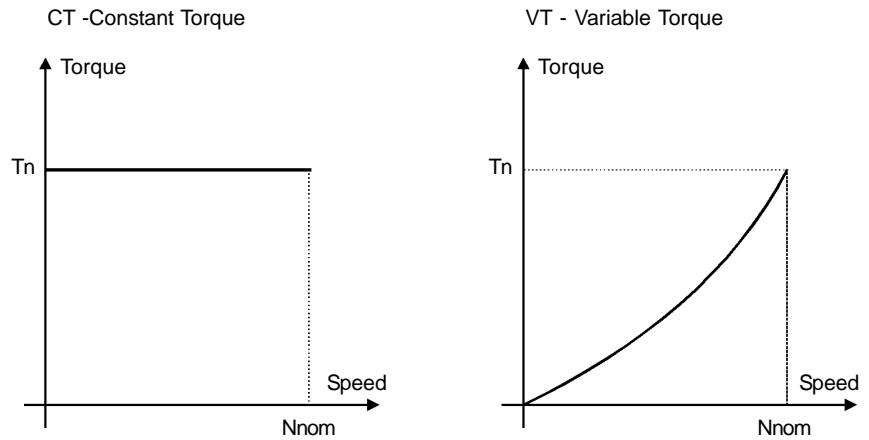

Figure 7.1 - Load Characteristics

(2)

The power rating in kVA is determined by the following equation:

$$P(\text{kVA}) = \frac{\sqrt{3} \cdot \text{Voltage(V)} \cdot \text{Current (Amp.)}}{1000}$$

The values shown on the Table were calculated, considering the inverter rated current rating and an input voltage of 230V for 220-230V models and 460V for 380-480V models

(3)

Rated Output Current in the following conditions:

- Relative Air Humidity: 5 to 90%, non condensing;
- Altitude : 3300 ft (1000m), up to 13200 ft (4000m) with 10% derating / 3300 ft (1000 m);
- Ambient Temperature: 32° to 104°F (0° to 40° C), up to 122°F (50° C) with 2% / °C derating;

(4)

- Maximum Current: 1.5 x I Nominal (for 60 seconds every 10 minutes). I Nominal = Rated Current for CT applications;
- The maximum output current is the same for CT and VT. That means a lower overload capacity in VT for the models with a higher rated current for VT than for CT.

Figure A.1 shows the configuration of the CFW-09...RB Capacitive Filter.

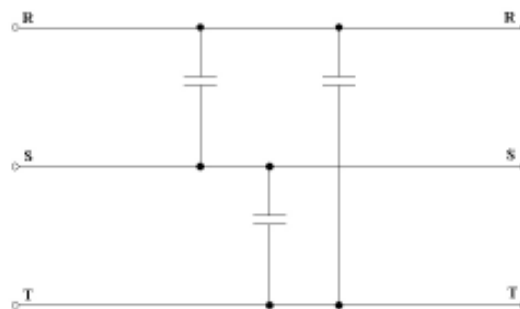

Figure A.1- CFW-09...RB Capacitive Filter

This capacitive Filter is supplied by WEG Automação in two different configurations for meeting the servodrive power:

- Module KMR1: for servodrives with current lower than 180A (WEG Item No. 417102043)
- Module KMR2: for servodrives with current equal to or higher than 180A (WEG Item No. 417102042)

Figure A.2 shows the KMR Filter Module.

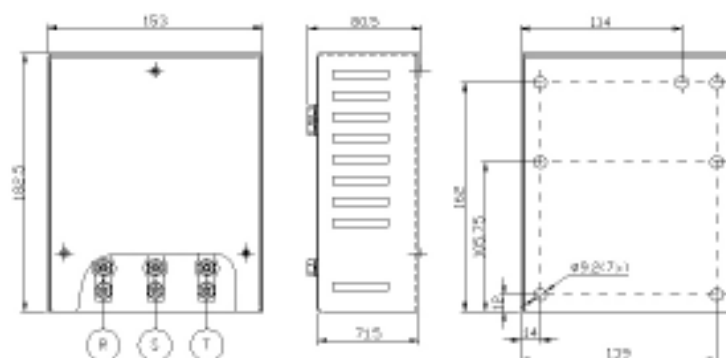

Figure A.2 - Kit KRB

The KMR1 module has a capacitor series connected between the input phases, whereas the KMR2 module is fitted with two capacitors parallel connected between the input phases.

The used capacitor is made of polypropylene film and has a capacitance of 0.56mF/1200V (ICEL-PMB2123560KSP, item WEG: 0302.4793).

- The CFW-09RB input reactance has special characteristics. Thus don't use a standard line reactance. Table XX shows the models and WEG Item Numbers for these reactances.

Voltage	Model	Item WEG of Reactance
220 V	105	0299.0047
	130	0299.0048
	180	0299.0049
	240	0299.0050
	361	0299.0125
	450	0299.0127
	600	0299.0129
230 V	105	0299.0051
	130	0299.0052
	180	0299.0053
	240	0299.0054
	361	0299.0126
	450	0299.0128
	600	0299.0130
380 V	86	0299.0055
	105	0299.0056
	142	0299.0057
	180	0299.0058
	240	0299.0059
	361	0299.0060
	450	0299.0061
400 V	600	0299.0062
	86	0299.0063
	105	0299.0064
	142	0299.0065
	180	0299.0066
	240	0299.0067
	361	0299.0068
440 V	450	0299.0069
	600	0299.0070
	86	0299.0071
	105	0299.0072
	142	0299.0073
	180	0299.0074
	240	0299.0075
480 V	361	0299.0076
	450	0299.0077
	600	0299.0078
	86	0299.0087
	105	0299.0088
	142	0299.0089
	180	0299.0090
480 V	240	0299.0091
	361	0299.0092
	450	0299.0093
	600	0299.0094

- For 460 V voltage use the 480 V reactance of the same model.
- For voltages not indicated in this table, contact WEG Automação.