

Lift vector AC Drives

AGL50-EV

Instruction Manual

Language: English

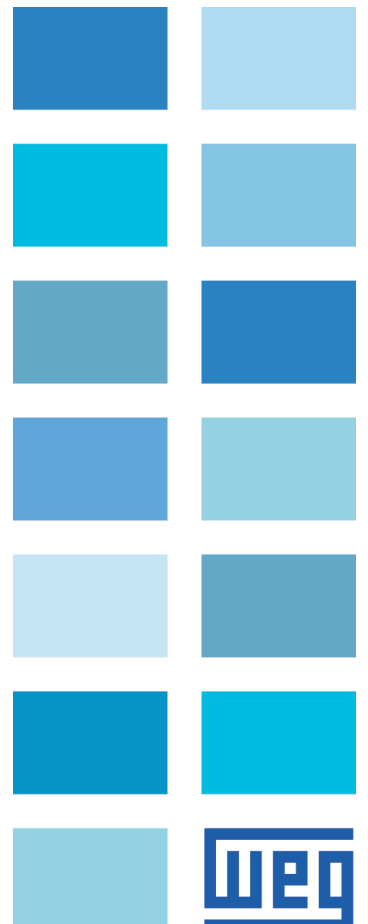

Thank you for choosing this WEG product.

We will be glad to receive any possible information which could help us improving this manual. The e-mail address is the following: techdoc@weg.net.

Before using the product, read the safety instruction section carefully.

Keep the manual in a safe place and available to engineering and installation personnel during the product functioning period.

WEG Automation Europe S.r.l. has the right to modify products, data and dimensions without notice.

The data can only be used for the product description and they can not be understood as legally stated properties.

This manual is updated according to firmware versions V03.06.XX and V03.07.XX.

All rights reserved.

Table of Contents

Safety Symbol Legend	4
1 - Safety Precautions	4
1.1 Discharge time of the DC-Link	6
2 - Introduction	6
3 - Environment	7
3.1 Environmental Conditions	7
3.2 Storage and transport	7
3.3 Standard.....	7
3.4 Input	8
3.5 AC Output.....	9
3.6 Open-Loop and Closed-Loop control section.....	10
3.7 Accuracy.....	10
3.8 Dimensions and installation guidelines	11
4 - Wiring Procedure	13
4.1 Power Section	13
4.2 EMC compliant electrical cabinet wiring rules.....	15
4.3 Cooling fans	16
4.4 Regulation Section	17
4.5 RS 485 Serial Interface	18
4.5.1 RS485 serial terminals.....	18
4.5.2 Serial protocol.....	18
4.6 Encoder Input.....	19
5 - Drive Keypad Operation	20
5.1 Keypad	20
5.2 Moving through the drive main menu.....	21
5.3 Scrolling through the drive parameters	22
5.4 Parameters modification	22
6 - Commissioning suggestions	23
7 - Default lift configuration	24
7.1 Command Logic	24
7.2 Lift Sequence	28
7.2.1 Lift-dedicated digital output functions.....	29
7.2.2 Speed indication	30
7.3 Ramp Function	30
7.3.1 Space calculation and acceleration / deceleration ramps settings	30
7.3.2 Short Floor Function	31
7.4 Startup Menu.....	32
7.5 Menü Display	36
7.6 Timer 1 function.....	38
8 - Troubleshooting	40
8.1 Drive Alarm Condition	40
8.2 Alarm Reset.....	40
8.3 List of drive alarm events	41
9 - Parameter list	42

Safety Symbol Legend



Indicates a procedure, condition, or statement that, if not strictly observed, could result in personal injury or death.



Indicates a procedure, condition, or statement that, if not strictly observed, could result in damage to or destruction of equipment.



Indicates a procedure, condition, or statement that should be strictly followed in order to optimize these applications.

Note!

Indicates an essential or important procedure, condition, or statement.

1 - Safety Precautions



According to the EEC standards the AGL50-EV and accessories must be used only after checking that the machine has been produced using those safety devices required by the 89/392/EEC set of rules, as far as the machine industry is concerned. These standards do not apply in the Americas, but may need to be considered in equipment being shipped to Europe.

Drive systems cause mechanical motion. It is the responsibility of the user to insure that any such motion does not result in an unsafe condition. Factory provided interlocks and operating limits should not be bypassed or modified.

Electrical Shock and Burn Hazard:

When using instruments such as oscilloscopes to work on live equipment, the oscilloscope's chassis should be grounded and a differential amplifier input should be used. Care should be used in the selection of probes and leads and in the adjustment of the oscilloscope so that accurate readings may be made. See instrument manufacturer's instruction book for proper operation and adjustments to the instrument.

Fire and Explosion Hazard:

Fires or explosions might result from mounting Drives in hazardous areas such as locations where flammable or combustible vapors or dusts are present. Drives should be installed away from hazardous areas, even if used with motors suitable for use in these locations.

Strain Hazard:

Improper lifting practices can cause serious or fatal injury. Lift only with adequate equipment and trained personnel.

Drives and motors must be ground connected according to the NEC.

Replace all covers before applying power to the Drive. Failure to do so may result in death or serious injury.

Adjustable frequency drives are electrical apparatus for use in industrial installations. Parts of the Drives are energized during operation. The electrical installation and the opening of the device should therefore only be carried out by qualified personnel. Improper installation of motors or Drives may therefore cause the failure of the device as well as serious injury to persons or material damage. Drive is not equipped with motor over-speed protection logic other than that controlled by software. Follow the instructions given in this manual and observe the local and national safety regulations applicable.

Always connect the Drive to the protective ground (PE) via the marked connection terminals (PE2) and the housing (PE1). AGL50-EV Drives and AC Input filters have ground discharge currents greater than 3.5 mA. EN 50178 specifies that with discharge currents greater than 3.5 mA the protective conductor ground connection (PE1) must be fixed type and doubled for redundancy.

The drive may cause accidental motion in the event of a failure, even if it is disabled, unless it has been disconnected from the AC input feeder.

Never open the device or covers while the AC Input power supply is switched on. Minimum time to wait before working on the terminals or inside the device is listed in section 1.1.



Do not connect power supply voltage that exceeds the standard specification voltage fluctuation permissible. If excessive voltage is applied to the Drive, damage to the internal components will result.

Do not operate the Drive without the ground wire connected. The motor chassis should be grounded to earth through a ground lead separate from all other equipment ground leads to prevent noise coupling.



The grounding connector shall be sized in accordance with the NEC or Canadian Electrical Code.

The connection shall be made by a UL listed or CSA certified closed-loop terminal connector sized for the wire gauge involved. The connector is to be fixed using the crimp tool specified by the connector manufacturer.

Do not perform a megger test between the Drive terminals or on the control circuit terminals.

Because the ambient temperature greatly affects Drive life and reliability, do not install the Drive in any location that exceeds the allowable temperature.

If the Drive's Fault Alarm is activated, consult the chapter 8. TROUBLESHOOTING of this instruction book, and after correcting the problem, resume operation. Do not reset the alarm automatically by external sequence, etc.

Be sure to remove the desiccant dryer packet(s) when unpacking the Drive. (If not removed these packets may become lodged in the fan or air passages and cause the Drive to overheat).

The Drive must be mounted on a wall that is constructed of heat resistant material. While the Drive is operating, the temperature of the Drive's cooling fins can rise to a temperature of 194° F (90°C).

Do not touch or damage any components when handling the device. The changing of the isolation gaps or the removing of the isolation and covers is not permissible.

Protect the device from impermissible environmental conditions (temperature, humidity, shock etc.)

No voltage should be connected to the output of the drive (terminals U2, V2, W2). The parallel connection of several drives via the outputs and the direct connection of the inputs and outputs (bypass) are not permissible.

A capacitive load (e.g. Var compensation capacitors) should not be connected to the output of the drive (terminals U2, V2, W2).

The electrical commissioning should only be carried out by qualified personnel, who are also responsible for the provision of a suitable ground connection and a protected power supply feeder in accordance with the local and national regulations. The motor must be protected against overloads.

No dielectric tests should be carried out on parts of the drive. A suitable measuring instrument (internal resistance of at least 10 kΩ/V) should be used for measuring the signal voltages.

In case of a three phase supply not symmetrical to ground, an insulation loss of one of the devices connected to the same network can cause functional problem to the drive, if the use of a delta/gye transformer is avoided (see par. 3.4).

Note!

If the Drives have been stored for longer than two years, the operation of the DC link capacitors may be impaired and must be "reformed".

Before commissioning devices that have been stored for long periods, connect them to a power supply for two hours with no load connected in order to regenerate the capacitors, (the input voltage has to be applied without enabling the drive).

Note!

The terms "Inverter", "Controller" and "Drive" are sometimes used interchangeably throughout the industry. We will use the term "Drive" in this document.

1.1 Discharge time of the DC-Link

Type	IN	Time (seconds)
2040	10.1	300
2055	13	300
2075	17.7	300

Tabella 1.1 DC Link Discharge Times

This is the minimum time that must be elapsed since a Drive is disconnected from the AC Input before an operator may service parts inside the Drive to avoid electric shock hazard.

Condition: These values consider a turn off for a Drive supplied at 480Vac +10%, without any option, (the charge for the switching supply is the regulation card, the keypad and the 24Vdc fans “if mounted”).
The Drive is disabled. This represents the worst case condition.

2 - Introduction

AGL50-EV is a series of dedicated drives used to control lift asynchronous motors ranging from 4 to 7.5 kW.

Thanks to the special lift application software, it is best used in case of plant modernization and, in general, in all open loop applications up to 1 m/s.

The easy and adaptable programming procedure can be managed via the alphanumeric keyboard or via the PC configurator and it allows the drive fast commissioning.

Available options on demand:

- External EMC input filters
- External Input / Output chokes
- External braking resistors (connected between terminals C and BR1).

3 - Environment

3.1 Environmental Conditions

Installation location _____	Pollution degree 2 or lower (free from direct sunlight, vibration, dust, corrosive or inflammable gases, fog, vapour oil and dripped water, avoid saline environment)
Installation altitude _____	Max 2000m (3281 feet) above sea level; above 1000m a current reduction of 1.2% for every 100m (328 feet) of additional height applies.
Mechanical conditions for installation _____	Vibrational stress: EN 60721-3-3 Class 3M1
Operation temperature _____	-10...50°C (14°...122°F). At above 40°, 2% derating for each °C, at 50°, 20% derating.
Air humidity (operation) _____	5 % to 85 %, 1 g/m ³ to 25 g/m ³ without moisture condensation or icing (Class 3K3 as per EN50178)
Air pressure (operation) [kPa] _____	86 to 106 (Class 3K3 as per EN50178)



Drive shall operate under environmental service conditions (climatic, mechanical, pollution, ...) defined in EN61800-2 as for "usual service conditions".

3.2 Storage and transport

Temperature:

storage _____	-20...+55°C (-4...+131°F), (class 1K4 as per EN50178)
transport _____	-20...+60°C (-4...+140°F), class 2K3 as per EN50178,

Air humidity :

storage _____	5% to 95 % (Class 1K3 as per EN50178)
transport: _____	95 % (3) 60 g/m (4)

A light condensation of moisture may occur for a short time occasionally if the device is not in operation (class 2K3 as per EN50178)

Air pressure:

storage _____	[kPa] 86 to 106 (class 1K4 as per EN50178)
transport _____	[kPa] 70 to 106 (class 2K3 as per EN50178)

- (3) Greatest relative air humidity occurs with the temperature @ 40°C (104°F) or if the temperature of the device is brought suddenly from -25...+30°C (-13°...+86°F).
- (4) Greatest absolute air humidity if the device is brought suddenly from 70...15°C (158°...59°F).

3.3 Standard

General standards _____	EN 61800-1, IEC 143-1-1.
Safety _____	EN 50178, EN 61800-5-1, UL508C,UL840 (PD2, OV3)
Climatic conditions _____	EN 60721-3-3, class 3K3. EN 60068-2-2, test Bd.
Clearance and creepage _____	EN 50178, UL508C, UL840. Overvoltage category for mains connected circuits: III; degree of pollution 2
Vibration _____	EN 60068-2-6, test Fc.
EMC compatibility _____	EN 12015 (with optional external EMI filter), EN 12016
Rated input voltages _____	IEC 60038
Protection degree _____	IP20 according to EN 60529 IP54 for the cabinet with externally mounted heatsink.
Approvals _____	CE according to LVD directives 2014/35 / EC and EMC 2014/30 / EC.

3.4 Input

Type		2040	2055	2075
ULN AC Input voltage	[V]	3 x 380 V (-15%) ... 3 x 480 V (+10%)		
Power supply system		TT, TN		
Maximum line voltage unbalance	[%]	3 %		
AC Input frequency	[Hz]	50 Hz – 2 % ... 60 Hz + 2 %		
THD of input current	[%]	> 100 % (without choke)		
IN AC Input current for continuous service ::				
- Connection with 3-phase reactor				
@ 400V _{AC} ; IEC 146 class 1	[A]	9	13	16
@ 480V _{AC} ; IEC 146 class 1	[A]	8.2	11.7	14.3
- Connection without 3-phase reactor				
@ 400V _{AC} ; IEC 146 class 1	[A]	11	14	19
@ 480V _{AC} ; IEC 146 class 1	[A]	10	12.6	17
Max short circuit power without line reactor (Z _{min} =1%)	[kVA]	500	650	850
Oversvoltage threshold (Oversvoltage)	[V]	800V _{DC}		
Undersvoltage threshold (Undersvoltage)	[V]	380 V _{DC} (for 380,400V _{AC} mains), 405 V _{DC} (for 420,440V _{AC} mains), 415 V _{DC} (for 460,480V _{AC} mains)		
Braking IGBT Unit		Standard internal (with external resistor); Braking torque 150%.		

Power Supply and Grounding

- 1) Drives are designed to be powered from standard three phase lines that are electrically symmetrical with respect to ground (TN or TT network).
- 2) In case of supply with IT network, the use of delta/wye transformer is mandatory, with a secondary three phase wiring referred to ground.



Caution

In case of a three phase supply not symmetrical to ground, an insulation loss of one of the devices connected to the same network can cause functional problem to the drive, if the use of a delta/wye transformer is avoided.

Please refer to the following connection sample.

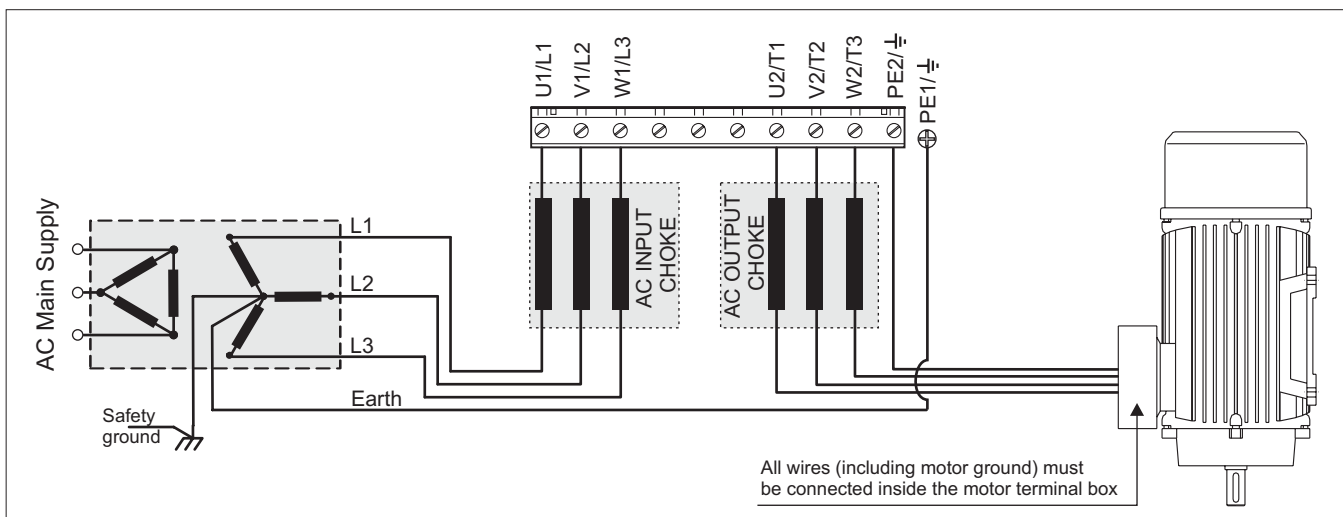

Mains connection and inverter output

The drive must be connected to an AC mains supply capable of delivering a symmetrical short circuit current lower or equal to the values indicated on table. For the use of an AC input choke see chapter 4.

Note from the table the allowable mains voltages. The cycle direction of the phases is free. Voltages lower than the min. tolerance values can cause the block of the inverter.

Adjustable Frequency Drives and AC Input filters have ground discharge currents greater than 3.5 mA. EN 50178 specifies that with discharge currents greater than 3.5 mA the protective conductor ground connection (PE1) must be fixed type.

AC Input Current

Note! The Input current of the Drive depends on the operating state of the connected motor. The tables (chapter 3.4) shows the values corresponding to rated continuous service, keeping into account typical output power factor for each size.

3.5 AC Output

Type		2040	2055	2075
P _{N MOT} (recommended motor output):	@ U _{LN} =400Vac; f _{sw} =default [kW]	4	5.5	7.5
	@ U _{LN} =460Vac; f _{sw} =default [Hp]	5	7.5	10
U ₂ Max output voltage	[V]	0.98 x U _{LN} (AC Input voltage)		
f ₂ Max output frequency	[Hz]	500 Hz (V/f)		
I _N Rated output current::	@ U _{LN} =400Vac; f _{sw} =default [A]	10.1	13	17.7
	@ U _{LN} =480Vac; f _{sw} =default [A]	8.6	11.7	14.9
Switching frequency f _{sw} (Default) (5)	[kHz]	8		
Switching frequency f _{sw} (higher) (5)	[kHz]	10,12		
I _{ovld}	[A]	Short term overload current. 170% of I _N for 10s on 100s.		
Derating factor	K _V (1)	0.87		
	K _T (2)	0.8		
	K _F (3)	0.85; 0.7		
	K _{ALT} (4)	1.2		
Braking unit intervention threshold (@ 380 V - 480 V)	[Vdc]	ON = 780 V _{dc} , OFF= 770 V _{dc} (6)		

- (1): Derating factor for mains voltage at 460 Vac
 (2): Derating factor for 50°C ambient temperature (2 % each °C > 40 °C)
 (3): Derating factor for higher switching frequency
 (4): Derating factor for installation at altitudes above 1000 meters a.s.l.. Value to be applied at each 100 m increase above 1000 m
 (5) It is possible to set a fixed switching frequency (from 4 to 12 kHz depending on size and with derating where applicable). Otherwise it is possible to set a variable switching frequency between two levels (hswf and lswf) defined according to size, heat sink temperature and stator frequency:

Type	Higher sw frequency [kHz]	Lower sw frequency [kHz]	F out [Hz]	T [°C]
2040	8	4	3	64
2055	8	4	3	60
2075	8	4	3	60

The output of the Drive is ground fault and phase to phase output short protected.

Nota! The connection of an external voltage to the output terminals of the Drive is not permissible! It is allowed to disconnect the motor from the Drive output, after the Drive has been disabled.

The rated value of direct current output (I_{CONT}) depends on the ambient temperature (K_T) and the switching frequency (K_F) if higher than the default setting:

$$I_{CONT} = I_N \times K_T \times K_F$$

(6) With parameter P.344 "BU threshold factor" is possible change the threshold in use:

$$BU\text{-On In use (Vdc)} = BU\text{-On (Vdc)} * P.344 / 100$$

3.8 Dimensions and installation guidelines

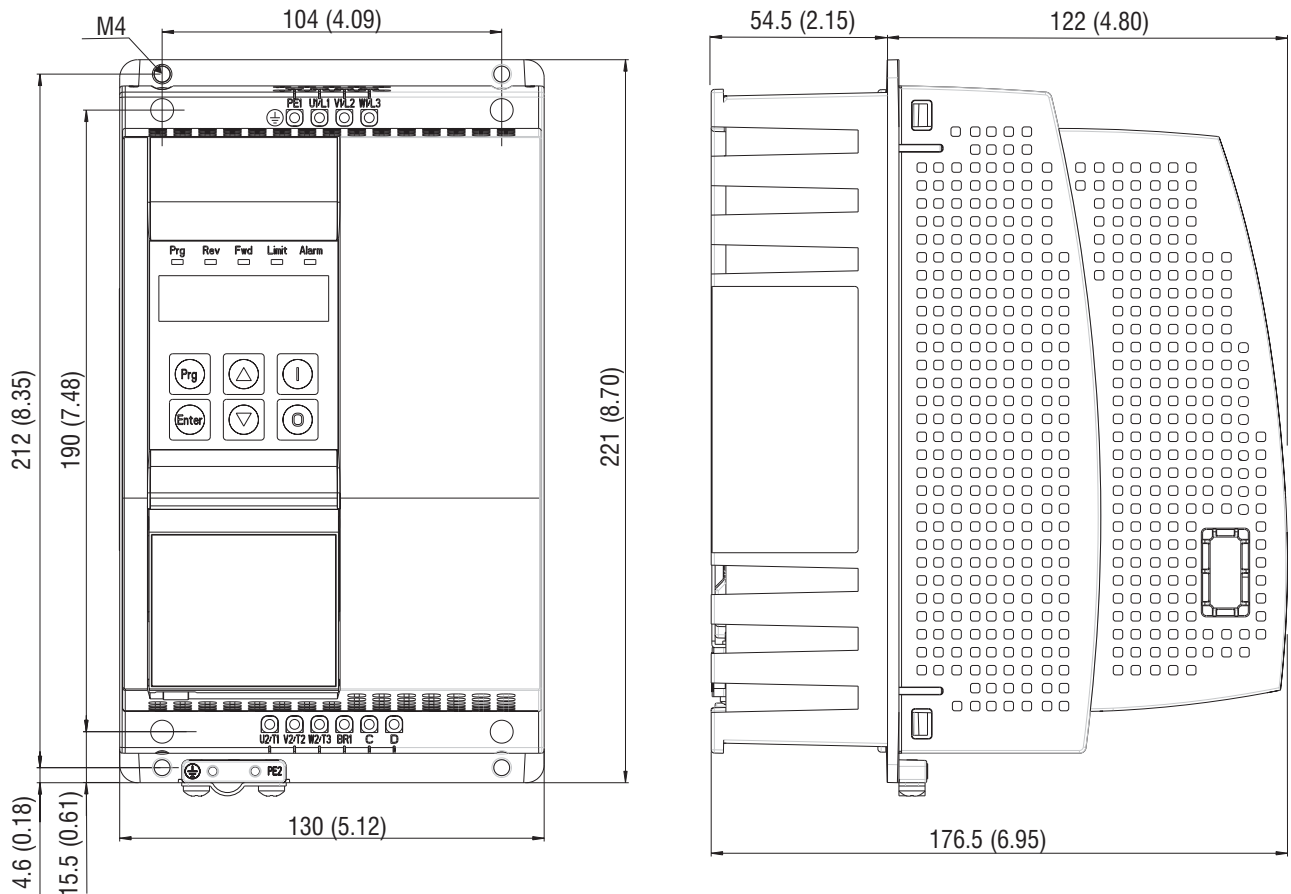

mm (inches)

Wall mounting

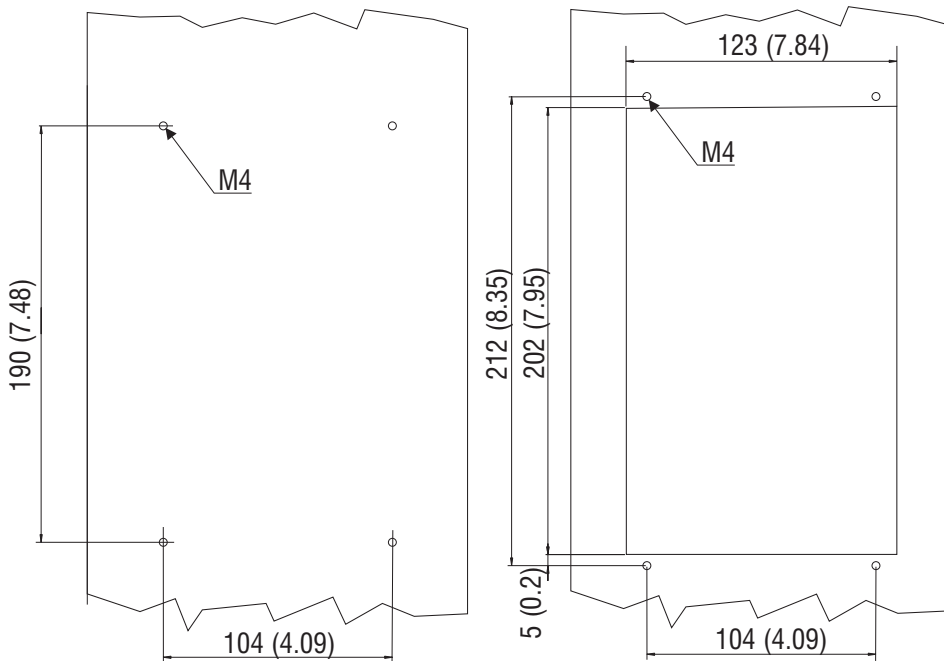

Mounting with external dissipator

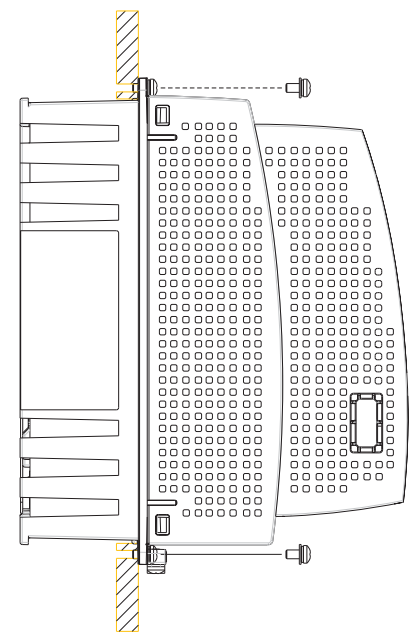

Type	Weight	
	[kg]	[lbs]
2040 ... 2075	3.0	6.6

Mounting Clearance

The Drives must be mounted in such a way that the free flow of air is ensured.

The clearance to the device must be at least 150 mm (6 inches).

A space of at least 50 mm (2 inches) must be ensured at the front.

Maximum angle of inclination: 30° with respect to the vertical axis.

Devices that generate a large amount of heat must not be mounted in the direct vicinity of the frequency inverter.

Fastening screws should be re-tightened after a few days of operation.

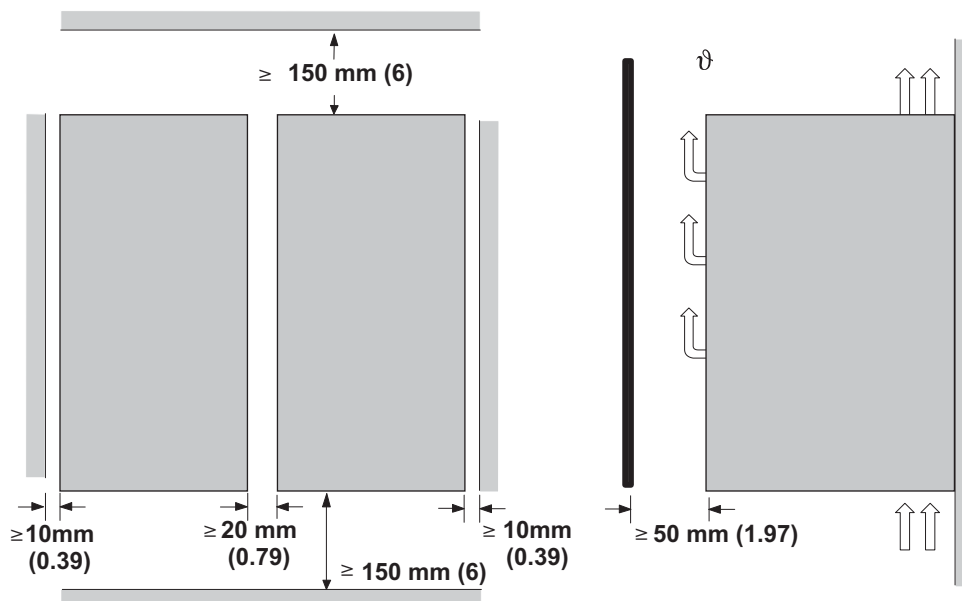

4 - Wiring Procedure

4.1 Power Section

U1/L1, V1/L2, W1/L3	AC mains voltage (3 x 380 V (-15%) ... 3 x 480 V (+10%))
PE1	Mains ground connection (on terminal)
BR1	Braking unit resistor command (braking resistor must be connected between BR1 and C)
C, D	Intermediate circuit connection
U2/T1, V2/T2, W2/T3	Motor connection
PE2	Motor ground connection (on chassis)

	Maximum cable cross-section		Recommended stripping	Tightening torque (min)
	(mm ²)	(AWG)	(mm)	(Nm)
2040 - 2055 - 2075	4 (rigid) / 2.5 (flexible)	12	8	0.5...0.6

Note! Use 60°C / 75°C copper conductor only.

External fuses of the power section

The inverter must be fused on the AC Input side.
Use fast-acting fuses only. Use the fuses shown in the table below.

Connections with three-phase inductance on AC input will improve the DC link capacitors life time.

Sizes	DC link capacitor hours of service life [h]	Europa		America	
		Type	Code	Type	Code
2040	10000	GRD2/20	F4D15	A70P20	S7G48
2055	10000	GRD2/25	F4D16	A70P30	S7I50
2075	10000	GRD2/25	F4D16	A70P30	S7I50

External fuses of the Power Section DC input side

Use fast-acting fuses only. Use the fuses shown in the table below.

Sizes	Europa		America	
	Type	Code	Type	Code
2040	GRD2/20	F4D15	A70P20	S7G48
2055	GRD2/25	F4D16	A70P30	S7I50
2075	GRD2/25	F4D16	A70P30	S7I50

Fuse manufacturers: Type GRD... , Z14... 14 x 51 mm Jean Müller, Eltville
A70... Ferraz
FWP... Bussmann

Input chokes

The three-phase mains choke is strongly recommended in order to:

- limit the RMS input current of the AGL50-EV inverter.
- increase the life of intermediate circuit capacitors and reliability of input diodes.
- reduce the harmonic distortion of the current absorbed by the grid to typical values of 70% (with rated current)

Sizes	THD	I _N @ 400 V [A]	Type	Code
2040	< 70 %	9	LR3y-2040	S7AAG
2055		13	LR3y-2055	S7AB5
2075		16	LR3y-2075	S7AB6

Use the following AC chokes to reduce the line current THD even more (< 35%).

Sizes	THD	IN @ 400 V [A]	Type	Code
2040	< 35%	8	LR3y-2040-35%	S7HB1
2055		12	LR3y-2055-35%	S7HB2
2075		15	LR3y-2075-35%	S7FO9

Output chokes

Output chokes are used to reduce the effects of the dv/dt of the power modules (IGBT). Voltage fronts can damage the electrical insulation of the motors or, if the motor cables are long (typically more than 100 m in length) or highly capacitive, they can cause drive malfunctions and the repeated generation of overcurrent (OC) or desaturation (OCH) alarms. The output chokes are listed in the table below:

Sizes	Mains inductance [mH]	Rated current [A]	Saturation current [A]	Type	Code
2040	0.87	10.1	20	LU3-QX02	S7FL3
2055	0.87	16	34	LU3-005	S7FG3
2075	0.51	27	57	LU3-011	S7FG4

Internal braking unit

Internal braking units with external braking resistors (wired between terminals C and BR1) are used to prevent dangerous DC link voltage levels in case of braking. Technical data of the internal braking unit (50% duty cycle)

Sizes	Rated current [Arms]	Peak current [Apeak]	Minimum braking R value [Ohm]
2040	5.7	8	100
2055	8.5	12	67
2075	8.5	12	67

Braking Resistors



Warning

The braking resistors can be subject to unforeseen overloads due to possible failures.

The resistors have to be protected using thermal protection devices. Such devices do not have to interrupt the circuit where the resistor is inserted but their auxiliary contact must interrupt the power supply of the drive power section. In case the resistor foresees the presence of a protection contact, such contact has to be used together with the one belonging to the thermal protection device.

Recommended resistors for use with internal braking unit:

Sizes	Resistor type	Code	Max Overload energy, 1"- duty-cycle 10%	Max Overload energy, 30"- duty-cycle 25% [kJ]	Pn cont (*) [W]	RBR [Ohm]
2040	RF 200 100R	S8SA15	1.5	4	200	100
2055	RF 200 68R	S8SA14	1.5	4	200	68
2075	RF 400 68R	S8SA16	3.5	10	400	68

Resistors protection degree: IP44.

The braking resistor is optional and has always to be mounted externally.

(*) rated power with continuous operation. Without heat sink.

If the resistors are mounted on unpainted radiation plates (thermal resistance shown) the power ratings are those shown in the table below. In overload conditions, heavier duty cycles can be set proportional to the power ratings.

Sizes	Radiator Therm. Res. (°C/W)	P Cont. serv. (W)
RF 200 100R	0.75	400
RF 200 68R	0.55	550
RF 400 68R	0.4	750

Optional EMC filters

An external EMI filter can be used to meet the requirements of EN 12015.

Sizes	Filter type	Code	EN61800-3 (Motor cable length)
2040	EMI-FTF-480-7	S7GHL	5 m
2055	EMI-FTF-480-16	S7GHO	5 m
2075	EMI-FTF-480-16	S7GHO	5 m

4.2 EMC compliant electrical cabinet wiring rules



In a domestic environment, this product may cause radio interference, in which case supplementary mitigation measures may be required.

Panels and cabinets

Mounting panel and cabinet (including the doors) have to be grounded, with a direct connection to the ground bus, using strapwire.

Removal of the paint from the support areas

The paint should be removed from the choke, mounting panel and chassis support areas.



The anodized aluminium does not conduct.

Ground terminals of the inverter

The inverters are provided with two ground terminals: one must be connected to the ground bus and the other to the filter.

Ground terminal of the choke

The earth terminal of the choke must be connected to the ground bus.

Shielding of cables for analog signals

Analog signals must be shielded (each signal must be contained in the screen united with the zero volt), the same is true for the constant references (E.g.. 10V). The shield must be grounded at 360° using the omega connectors available on the support panel of the regulation board. This is in front of the terminals strip on the bar above the board.

Note! Cable shields should be grounded at one end only.

Min. distance between signal and power cables

The minimum distance between parallel signals and power cables is 30cm (12 inches). Possible crossings have to be made at 90°. In case of double cabinets (entry to the inside of the cabinet on both sides with 2 different panels installed) it is advisable to have all signals cables conveyed into troughs mounted on the inverter side (front) and to pass motor cables on the other side (back) trough. In case of single cabinets, it is advisable to let the power cable run vertically, while signal cables run horizontally, keeping the maximum possible distance.

Shielding of the supply for an AC motor

The AC motors have to be supplied through a four pole shielded cable (three phases plus a green/yellow ground wire), or through four unshielded cables, which are inserted inside a metal channel. It is important that a direct connection (four cables) between the panel grounding and the motor ground has been made and that the fourth cable had been inserted in a shield.

Ground connection to both sides of the cable shield (AC motor)

The shield of the supply cable of the AC motors must be grounded on both sides in order to obtain 360° contact, that means the whole shield. This can be accomplished using suitable metallic EMC cables press grounded at a full 360° at the input of the cabinet and of the motor's terminal strip. If this connection is not possible, the shielded cables should be brought inside the cabinet and connected with an omega connector to the mounting panel. The same must be done on the motor side. In case a 360° connection on the motor's terminal strip is not possible, the shield must be grounded before entering into the terminal strip. This should be done on the metal support of the motor, using an omega connector (see figure). In case a metal duct has to be used, it should be grounded at a full 360° where possible.

Pigtail avoidance

While grounding the shields of the cables, one has to use a 360° connection (E.g.: omega bus as in the figure 4.2) with a pigtail connection to be absolutely avoided. By pigtail is meant the connection to earth ground of the cable shield by means of an additional wire.

Direct connection between the ground bus and motor chassis

Independently from ground-connection of the motor's chassis, it must always be connected to the ground wire (yellow/green) coming from the panel ground bus.

Max length of the AC motor's cables inside the cabinet

From the grounding of the screen side cabinet of the inverter terminal strip, the supply's cables have to measure 5 meters (16.4 feet) maximum.

Mounting sequence for EMI-... filters with inverter

In case of inverters, these filters have to be serie-connected between the inverter and the AC mains. The connection between the filter and inverter's terminals must be done with a four poles cable, whose max.length is 30 cm. (12 inches). If that connection is longer, the cable must be shielded.

Grounding of EMI-... filters with inverter

The yellow/green ground wire of the four poles cable must be connected on one side directly to one of the two grounding terminals of the inverter, the other side to one of the two filters grounding terminals. The other grounding terminal of the filter must be brought directly to the grounding bus of the cabinet.



Figura 4.2.OMEGA plug: grounding 360° of a shielded cable.

4.3 Cooling fans

No connection is required, the internal fans are power supplied by an internal circuit.

Sizes	Heat dissipation) [W]	Fan capacity	
		Heat sink [m³/h]	Internal [m³/h]
2040	180	20	-
2055	205	2 x 20	-
2075	280	2 x 20	11

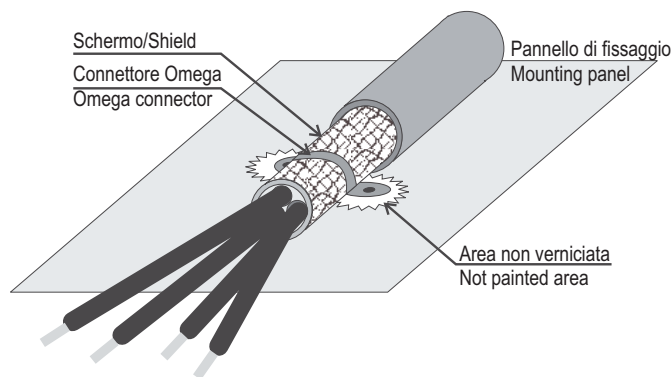
4.4 Regulation Section

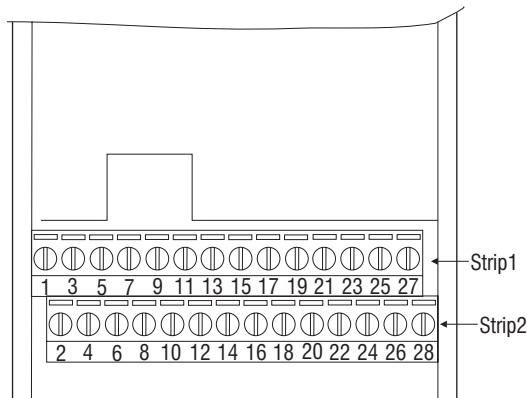

STRIP 1			
Term.	Designation	Function	(Signal level MAX)
1/3	n.a.		
5	Analog output 1	VOLTAGE programmable analog output Default : I.300 = [0] Freq out abs	(0...10V) (0...10V / 5mA)
7	+ 10V OUT	+ 10 Vdc potential voltage reference Default : n.a.	(+10Vdc / 5mA, max 10mA)
9	- 10V OUT	- 10 Vdc potential voltage reference Default : n.a.	(-10Vdc / 5mA, max 10mA)
11	Digital output 1+	Programmable digital output (Optomos) Default : I100 = [51] Contactor	(+30V / 40mA)
13	Digital output 1-	Programmable OPEN COLLECTOR digital output (negative terminal)	
15	RS485 Link+	Link+ (RxA / TxA) signal of RS 485 serial line	
17	RS485 Link-	Link- (RxB / TxB) signal of RS 485 serial line	
19	RS 485 eq. ref.	Equipotential reference of RS 485 serial line	
21	COM Relay 1	Common contact RELAY 1 digital output	(250Vac / 2A, 30Vdc / 2A)
23	Digital output 1	Programmable RELAY digital output, NO contact Default : I101 = [54] Brake cont	(250Vac / 2A, 30Vdc / 2A)
25	COM Relay 2	Common contact RELAY 2 digital output	(250Vac / 2A, 30Vdc / 2A)
17	Digital output 2	Programmable RELAY digital output, NO contact Default : I102 = [02] No alarms	(250Vac / 2A, 30Vdc / 2A)
STRIP 2			
Term.	Designation	Function	(Signal level MAX)
2/4	n.a.		
6	COM analog. In/Out	Potential reference of analog inputs/outputs	-
8	Analog input 1	Programmable VOLTAGE analog input Default : I.200 = [1] -10...+10V	(±10V / 0.5mA)
10	0 V 24	0 V 24 potential reference	
		Programmable digital inputs	(24Vdc / 5mA, 12...30Vdc max)
12	Digital input 1	Default : I.000 = Enable src	
14	Digital input 2	Default : I.001 = Run Fwd src	
16	Digital input 3	Default : I.002 = Run Rev src	
18	Digital input 4	Default : I.003 = Freq sel 1 src	
20	Digital input 5	Default : I.004 = Freq sel 2 src	
22	Digital input 6	Default : I.005 = Freq sel 3 src	
24	COM Digital inputs	0 potential reference of digital inputs	
26	0 V 24	0 V 24 potential reference	
28	+ 24V OUT	+ 24 Vdc potential voltage reference	(+21Vdc / 75mA)

n.a. = not assigned

4.5 RS 485 Serial Interface

The RS 485 serial line on the drives of the AGL50-EV series allows the data transmission through a loop made of two symmetrical conductors, which are twisted with a common shield. The maximum transmission speed is 38400 Baud. The transmission is performed via a standard RS 485 differential signal (half-duplex).

If two or more drives are connected on the serial line (Multidrop configuration), the OPT-QX option has to be used on each device.

This option has to be inserted between the inverter terminals and the transmission data cable.

With the Multidrop configuration it is possible to connect a maximum of 20 units of AGL50-EV inverters (for further details see the OPT-QX manual).

The shield of serial line cable must be connected to the ground.

4.5.1 RS485 serial terminals

The RS 485 serial line is supplied through 15, 17 and 19 terminals, placed on the regulation card of the inverter. The differential signal is transmitted on the Pin 15 (TxA/RxA) and on the Pin 17 (TxB/RxB). Terminal 19 is used as equipotential reference of the serial line.

Note! As for the connection of the serial line, make sure that the power cables and the cables controlling the contactors and the auxiliary relays are located into different panduits.

4.5.2 Serial protocol

The serial protocol is set via the “**1.600 - Serial link cfg**” parameter, which allows the selection of the following types: proprietary protocol FoxLink, RTU Modbus (default) and Jbus.

The serial address is set via the “**1.602 - Device address**” parameter. Further details about the parameter transmission, the parameter type and the value range can be found in the tables of Chapter 7.1 (INTERFACE Menu / Serial Configuration).

Figure 4.5.2.1: Serial Connections

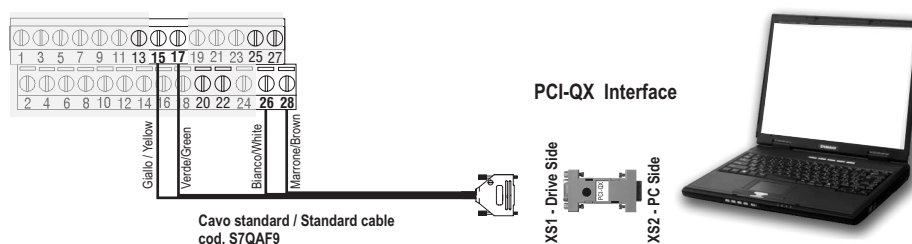

PCI-QX	Wire colour	Signal	AGL50-EV terminals
Pin 3	Yellow	Link +	15
Pin 7	Green	Link -	17
Pin 1	Brown	+ 24V Supply	28
Pin 8	White	0V Supply	26

4.6 Encoder Input

Figure 4.6.1: encoder connection

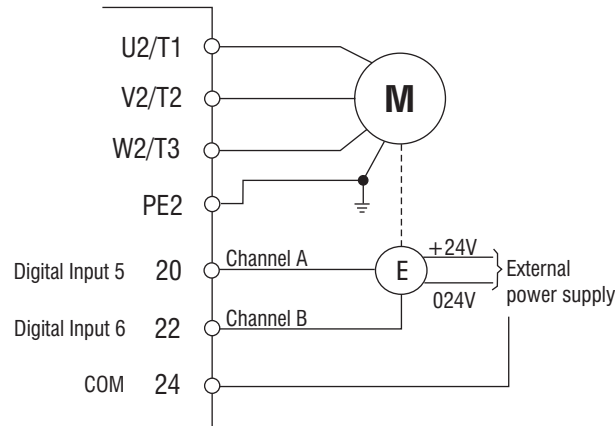

Table 4.6.1: Recommended Cable Section and Length for the Connection of Encoders

Cable section [mm ²]	0.22	0.5	0.75	1	1.5
Max Length. m [feet]	27 [88]	62 [203]	93 [305]	125 [410]	150 [492]

Requirements:

Digital encoder:

- max frequency: 25 kHz (select the appropriate number of pulses depending on required max. speed)
- Channels :
 - one-channel: A (one-channel complementary A-, NOT allowed)
 - two-channel: A and B (two-channel complementary A- and B-, NOT allowed).

Encoder loss detection is not possible.

- Power supply: + 24V externally supplied.
- The digital inputs common (terminal 24) have to be rightly connected to the external supply:
 - to 0 V of supplier, if the encoder is PNP type
 - to + 24 V of supplier, if the encoder is NPN type.

Note! If **Digital input 5** and **Digital input 6** are used as encoder input, **I.004** and **I.005** must be set to **[0] None**.
Then encoder feedback parametrization must be execute.

5 - Drive Keypad Operation

In this chapter the parameters management is described, by using the drive keypad.

5.1 Keypad



Changes made to parameter have immediate effect on drive operation, but are not automatically stored in permanent memory. An explicit command is required to permanently store the parameters: "**C.000 Save parameters**".

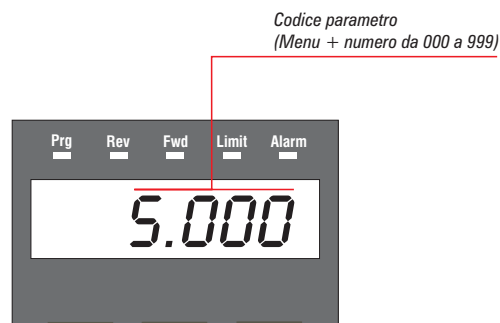
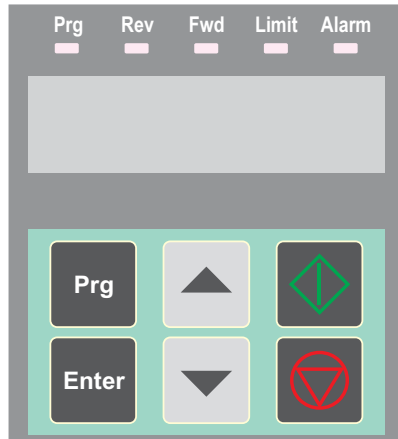

Menu:
d=DISPLAY
S=STARTUP
I=INTERFACE
F=FREQ & RAMPS
P=PARAMETER
A=APPLICATION
C=COMMAND

- Prg** Scroll menù: Allows navigation through the drive main menu (**d.xxx**, **S.xxx**, **I.xxx**, **F.xxx**, **P.xxx**, **A.xxx** and **C.xxx**). Also used to exit the editing mode of a parameter without applying the changes.
- E** Enter key: Used to enter the editing mode of the selected parameter or to confirm the value.
- ▲** UP key: Used to scroll up through parameters or to increase numeric values while in editing mode; it can also be used to increase motorpotentiometer reference value, when **F.000 Motorpot ref** parameter is displayed (F, FREQ RAMP menu).
- ▼** DOWN key: Used to scroll down through parameters or to decrease numeric values while in editing mode; it can also be used to decrease motorpotentiometer reference values, when **F.000 Motorpot ref** parameter is displayed (F, FREQ RAMP menu).
- I** Start key: Used to **START** the drive via keypad; requirements:
 +24V between 12 & 26 terminals (Enable)
 +24 V between 14 & 26 terminals (Run Fwd) or + 24 V between 16 & 26 terminals (Run Rev)
P.000 Cmd source sel = [1] CtlWrd & kpd parameter setting
- O** Stop key: Used to **STOP** the drive via keypad;

Keypad LED's meaning:

- PRG** (Yellow Led) Flashes if the parameters have not been permanently saved to memory.
- REV** (Green Led) Reverse running
- FWD** (Green Led) Clockwise motor rotation
- Limit** (Yellow Led) Inverter limit state
- Alarm** (Red Led) Inverter alarm state

Note! The FWD LED lights up during the direct current injection phase (start and stop).

5.2 Moving through the drive main menu

Soon after, the keypad display will show **d.000 Output frequency** parameter of DISPLAY menu.

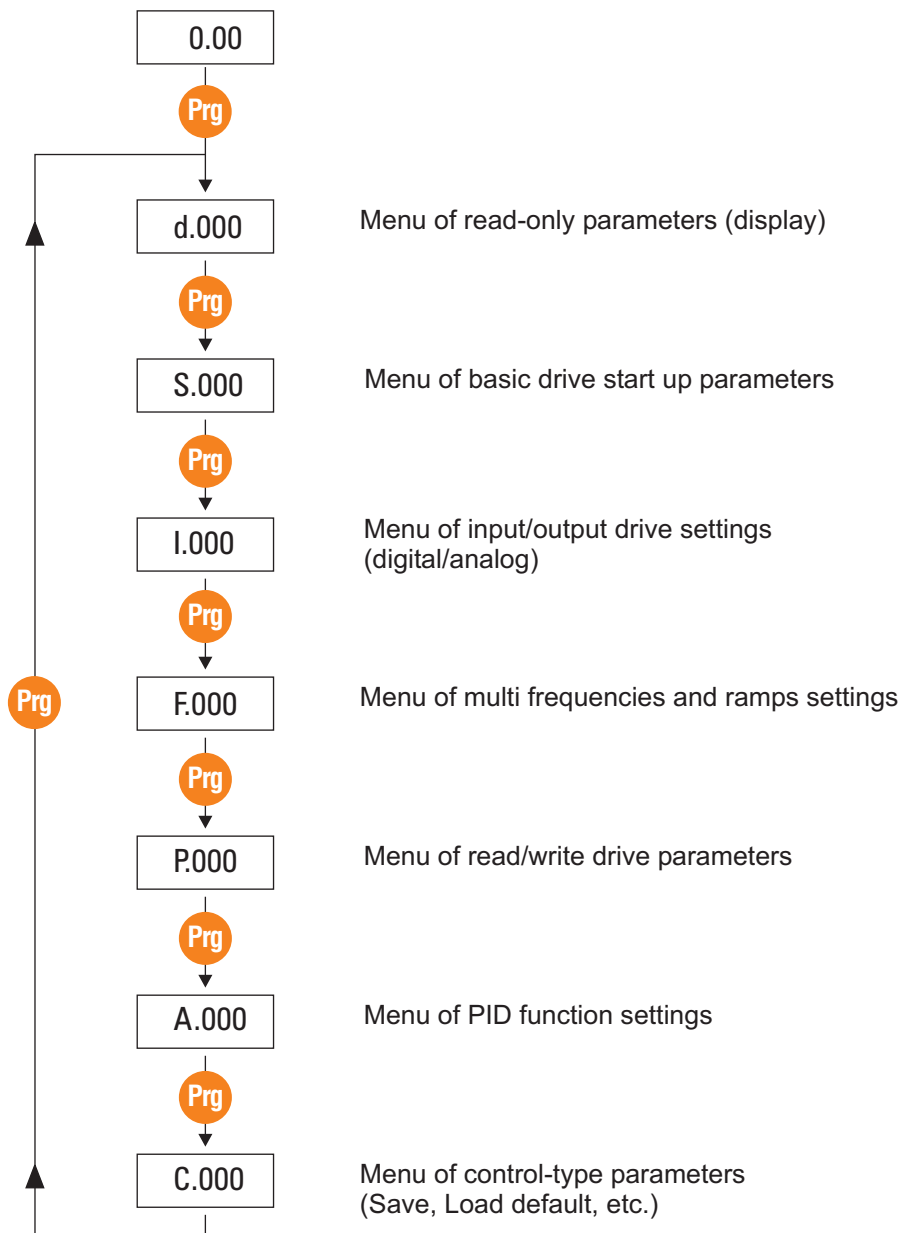

5.3 Scrolling through the drive parameters

STARTUP menu example:

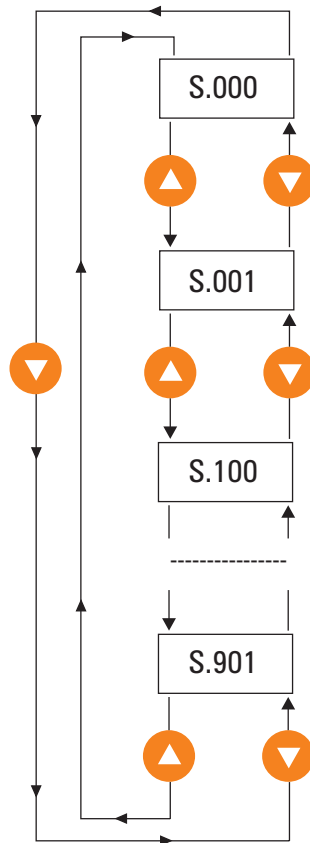

5.4 Parameters modification

Example: how to change a frequency reference (STARTUP menu).

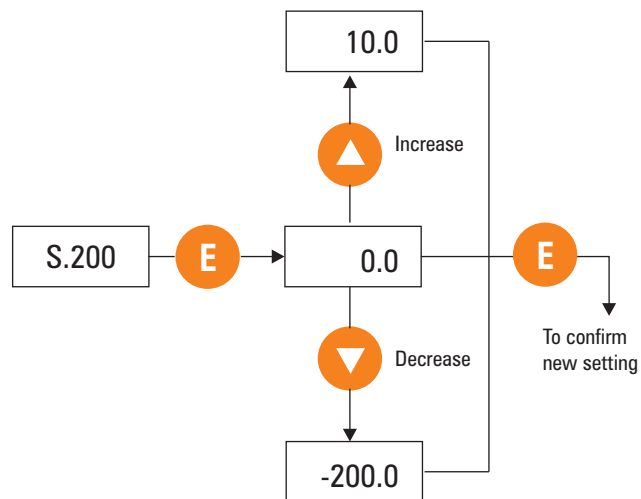

Note!

Same procedure is also valid to Enable/Disable a function (ex.: **S.301 Auto boost en**) or program the drive I/Os (i.e.: **I.100 Dig output 1 cfg**, etc. ...).

6 - Commissioning suggestions

Before changing the parameter settings make sure that the starting values are default values.

Change the parameters one at the time; if the change on any parameter is not effective, restore the parameter initial value before changing another one.

- In order to avoid problems linked to running comfort, it is advisable to perform a preliminary control of the motor parameters.

Check in the **STARTUP** menu that the value set in the following parameters corresponds to the motor nameplate data:

S.100 Base voltage	Inverter maximum output voltage (Vrms).
S.101 Base frequency	Motor base frequency (Hz).
S.150 Motor rated curr	Motor rated current (Arms).
S.151 Motor pole pairs	Number of motor polepairs.
S.152 Motor power fact	(cos phi) Motor input power factor with rated current and voltage.

- In order to avoid too high settings of the acceleration and deceleration values (jerk), make sure that the slowing-down distances correspond to those listed in the table:

Suggested slowing-down distances

Plant rated speed	(m/s)	0,6	0,8	1,0
Suggested slowing-down distance	(mm)	800	1000	1300

Such distances grant a high running comfort with the factory set jerk values.

- The default speed levels can be selected on the terminal 18. It is advisable to use the frequencies as follows:

S.200 Frequency ref 0	Slow speed: it is the floor reaching speed (frequency)
S.201 Frequency ref 1	High speed: it is the rated speed (frequency) required by the motor for that specific plant.

Other speeds (maintenance, rephasing procedure etc.) can be selected as per table 7.2.

- In the open loop plants (without encoder), the boost can be increased if the lift car tends to rotate in the opposite direction during the starting phase or if it can not start in spite the running speed has been set (**S.300 Manual boost**, default = 3). The boost should be gradually increased by 1% at the time. Too high values cause the intervention of the current limit alarm.

7 - Default lift configuration

Lift commands are part of a dedicated control word. Each command is assigned to a physical digital input terminal. All the main commands are given from the DI on the standard regulation board (see table 7.1).

Similarly, lift digital outputs are configured to perform the most common functions needed to realize a standard application, such as run and brake contactor control logic.

In AGL50-EV drives, commands are always coming from **Lift Control Word**. It is possible to issue the **Run Fwd** or **Run Rev** commands from keypad, in order to simplify the startup procedure.

Frequency references are coming from the multi-speed selector, which is the required setting for most applications.

However, it is possible to use other sources for the frequency reference, such as analog inputs or Motopotentiometer.

Ramps are initialized to a standard set of jerks and acceleration/deceleration that should meet the requirements of most low speed applications. It is possible, though not recommended, to disable the S-shape and use linear profiles (F.250 = 0). In that case the jerk parameters will have no effect.

7.1 Command Logic

In the standard version, drive commands may come from several different sources (keypad, terminals, serial line etc.).

In the Lift version the parameter defining the source of the commands can only assume the following values:

P.000 Cmd source sel = “[0]CtrlWordOnly”

Command assignment

Drive command	Source parameter	Default setting		Possible setting	IPA
		Setting	Terminal		
Enable src	I.000	[2] DI 1	12	[0] False [1] True [2] DI 1 [3] DI 2 [4] DI 3 [5] DI 4 [6] DI 5 [7] DI 6 [8] DI 7 [9] DI 8 [10] DI Exp 1 [11] DI Exp 2 [12] DI Exp 3 [13] DI Exp 4 [14] AND 1 [15] AND 2 [16] AND 3 [17] OR 1 [18] OR 2 [19] OR 3 [20] NOT 1 [21] NOT 2 [22] NOT 3 [23] NOT 4 [24] FrqSel match [25] Short Floor flg [26] Contactor (fw 03-07) [27] Timer 1 (fw 03-07)	100
Run Fwd src	I.001	[3] DI 2	14	See list of I.000	101
Run Rev src	I.002	[4] DI 3	16	See list of I.000	102
Freq Sel 1 src	I.003	[5] DI 4	18	See list of I.000	103
Freq Sel 2 src	I.004	[6] DI 5	20	See list of I.000	104
Freq Sel 3 src	I.005	[7] DI 6	22	See list of I.000	105
Freq Sel 4 src	I.006	[0] False		See list of I.000	106
Ramp Sel 1 src	I.007	[25] Short Floor Flg		See list of I.000	107
Ramp Sel 2 src	I.008	[0] False		See list of I.000	108
Ext fault src	I.009	[0] False		See list of I.000	109
Src Reset Allarm	I.010	[0] False		See list of I.000	110
Bak pwr act src	I.011	[0] False		See list of I.000	111
Forced stop src	I.012	[0] False		See list of I.000	185

Table 7.1 – Command assignment

Each command may come from any of the drive digital input terminals (either standard or expanded), or can be a logical combination of terminal inputs, obtained by using the drive internal programmable area

It is anyway possible to assign commands different from the default ones:

For example, if we want the **Enable** command to come from the digital input 3 of the drive (terminal 16 on the regulation board), we have to set parameter **I.000 Enable src** to the value "[4] DI 3".

Note: If the source of a command is specified as an expanded DI, and the I/O expansion board is not mounted, the command will always be inactive (FALSE).

A brief description of each command follows.

Enable src The **Enable** command must always be present, in order to activate the inverter output bridge. If the **Enable** input is not present, or the Enable signal is removed at any time during the Lift sequence, the output stage of the drive is disabled, and the Run contactor is open, regardless of the status of all the other inputs.

Run Fwd src (Upward command)
Closing the input 14, the upward Lift sequence is started (see Figure 7.1).

Run Rev src (Downward command)
Closing the input 16, the downward Lift sequence is started (see Figure 7.1).

Note: The direction of the motion can also be reversed by setting a negative frequency reference. With a negative frequency reference, the **Run Fwd src** command will cause a downward motion, while a **Run Rev src** command will cause the cabin to move upward.

Note: The lifting sequence will not start if both **Run Fwd src** and **Run Rev src** commands are activated at the same time.

Freq Sel 1 ... 4 src (Selection of the speed reference)

The binary code defined by the status of these signals selects the frequency reference (speed) for the ramp generator (see Fig.7.2), according to the following table:

Freq Sel 4	Freq Sel 3	Freq Sel 2	Freq Sel 1	Code	Active frequency reference
Terminal XX	Terminal 22	Terminal 20	Terminal 18		
0	0	0	0	0	S.200 Rif frequenza 0
0	0	0	1	1	S.201 Rif frequenza 1
0	0	1	0	2	S.202 Rif frequenza 2
0	0	1	1	3	S.203 Rif frequenza 3
0	1	0	0	4	S.204 Rif frequenza 4
0	1	0	1	5	S.205 Rif frequenza 5
0	1	1	0	6	S.206 Rif frequenza 6
0	1	1	1	7	S.207 Rif frequenza 7
1	0	0	0	8	F.108 Rif frequenza 8
1	0	0	1	9	F.109 Rif frequenza 9
1	0	1	0	10	F.110 Rif frequenza 10
1	0	1	1	11	F.111 Rif frequenza 11
1	1	0	0	12	F.112 Rif frequenza 12
1	1	0	1	13	F.113 Rif frequenza 13
1	1	1	0	14	F.114 Rif frequenza 14
1	1	1	1	15	F.115 Rif frequenza 15 (Emergency run freq)

Table 7.2 – Multi-frequencies selection

Note: The last multi-frequency has also a special meaning when using the backup power supply. If the drive is being fed by the backup power supply, the frequency reference is clamped to the value defined by the parameter **F.115**.

If the backup power supply is not used, **F.115** can be used as one of the multi-frequencies and is selected by setting to TRUE all the selectors (**Freq Sel 1** to **Freq Sel 4**).

- Ramp Sel 1 ... 2** The binary code defined by the status of these signals selects the set of parameters for ramp profile (jerks, acceleration and deceleration). By default, the first ramp selector is commanded by the **ShortFloorFI** (see chapter 7.3), while the second ramp selector is fixed to FALSE. Therefore, the first ramp set is normally active, and the drive will automatically switch to the second ramp set whenever a short floor is detected (see Fig.7.5).
- External fault** Activation of this command, will cause the drive to trip with an external fault alarm. If the alarm occurs while a lift sequence is in process, the sequence is immediately aborted and the Run contactor is open. In order to restore drive operation, an explicit **Alarm Reset** command is needed.
- Fault reset src** (Alarm reset) Activation of this command will restore drive operation after a trip.
- Bak pwr act src** This command tells to the drive that a backup power supply is being used. See chapter 9 for a detailed description.

In order to simplify the drive startup, it is possible to issue **Run Fwd src** or **Run Rev src** commands from the “I-O” keys of the drive keypad.

Typical example:

The user wants to execute tuning of the motor resistance, but does not want to issue the start sequence from the external PLC. In this case, it is possible to program the drive as follows:

- Set parameter **P.000 Cmd source sel** = “[1] CtlWrd & kpd”
- Set parameter **I.000 Enable src** = “[1] True”
- Set parameter **I.001 RunFwd src** = “[1] True”
- Issue the command for tuning, by setting **C.100 Measure stator R** = [1]; the drive keypad will show the message “tune”.
- Press the “I” key; the keypad will show the message “run”, meaning that the tuning procedure is in progress. Wait until the procedure ends, and the keypad will show the message “done”.

Nota: The motor output contacts must be closed during the tuning procedure, in order to allow current to flow into the motor. Either hard-wire the RUN contactor closed during tuning procedure, or connect the dedicated output of the drive to the RUN contactor.

- Once the tuning procedure is finished, restore the original settings for the parameters above, following the order:
I.001 Run Fwd src = “[3] DI 2”
I.000 Enable src = “[2] DI 1”
P.000 Cmd source sel = “[0] CtrlWordOnly”

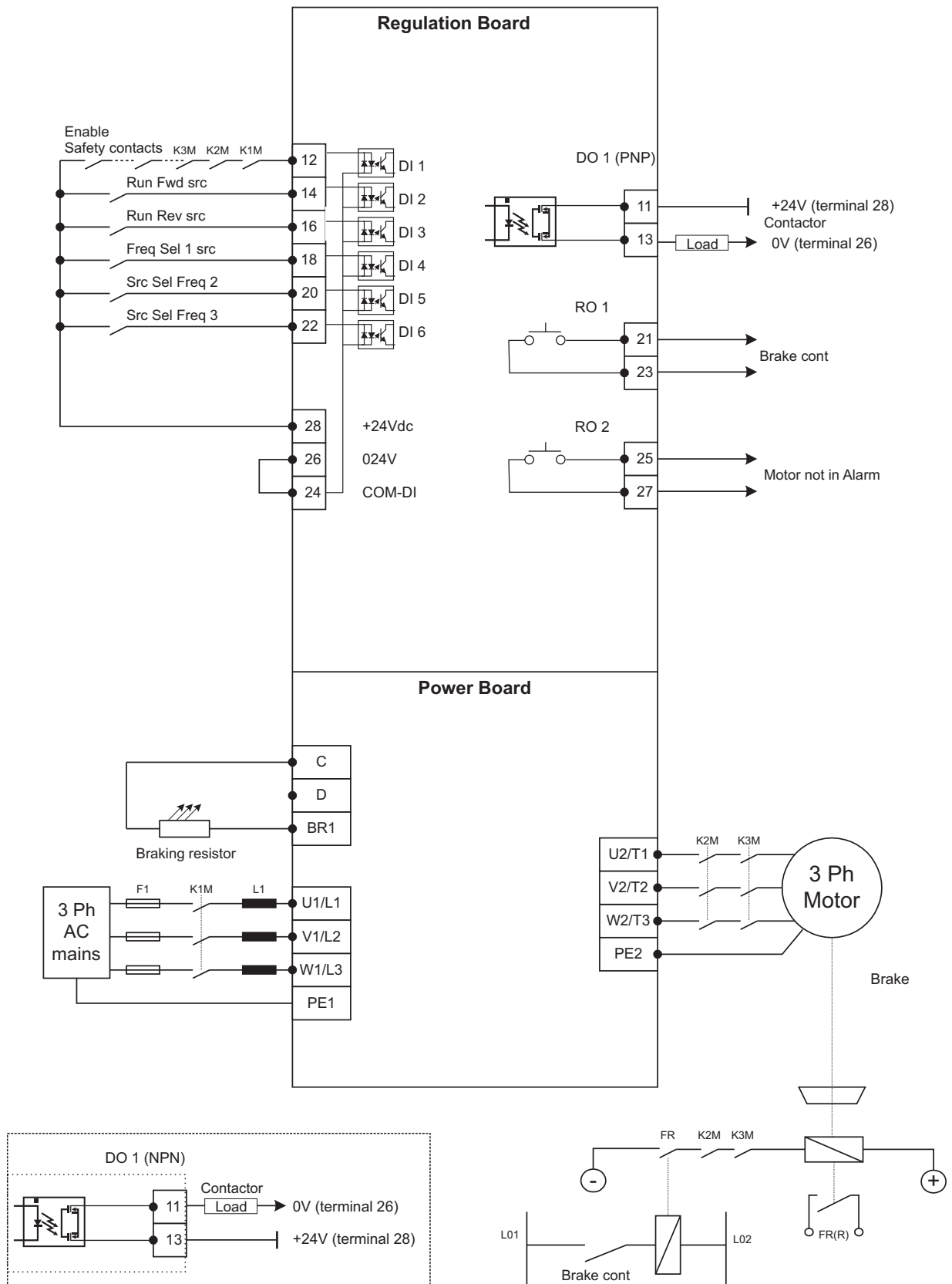

Fig.7.1 – Lift standard wiring

Note! The connections indicated for command inputs represent the most common solution for an PNP type command. Digital I/Os with internal supply.

7.2 Lift Sequence

Timing diagrams of the lift sequence are reported in Fig. 7.2 and Fig. 7.3.

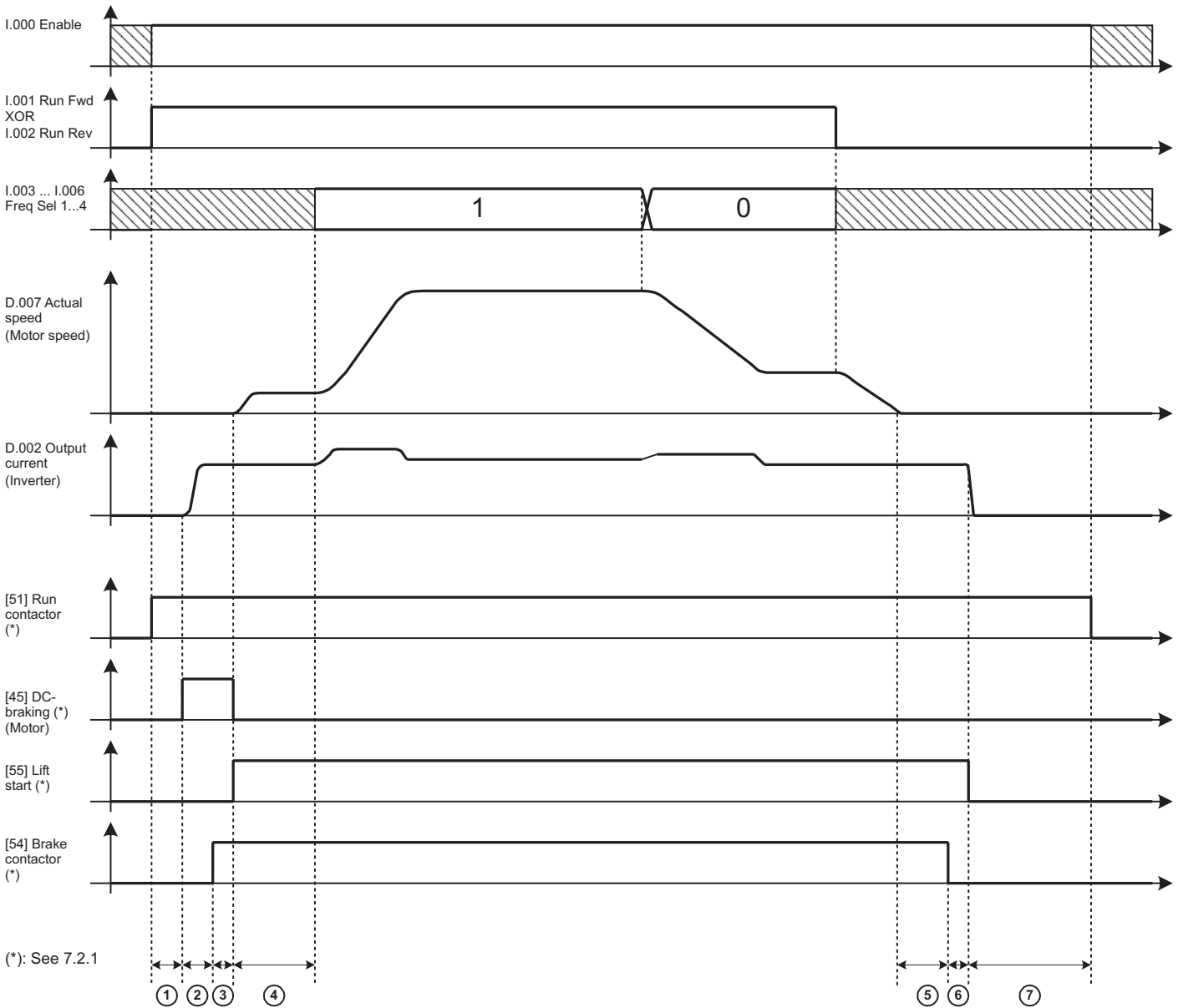

Fig. 7.2 – Standard lift sequence

- | | | |
|----|------------------------|------------------|
| 1. | S.250 Cont close delay | (Default : 0,20) |
| 2. | S.251 Magnet time | (Default : 1) |
| 3. | S.252 Brake open delay | (Default : 0,20) |
| 4. | S.253 Smooth start dly | (Default : 0) |
| 5. | S.254 DCBrake stp time | (Default : 1) |
| 6. | S.255 Brake close dly | (Default : 0,20) |
| 7. | S.256 Cont open delay | (Default : 0,20) |

Note: Lift sequence will not start if there is no current flowing on any of the motor windings during the initial injection of DC-current. The minimum amount of current necessary to release the mechanical brake and initiate the lift sequence is defined by **A.087 Current pres thr**. By setting the parameter to "0", current check is disabled, and the lift sequence will start even if the motor is disconnected from the drive.

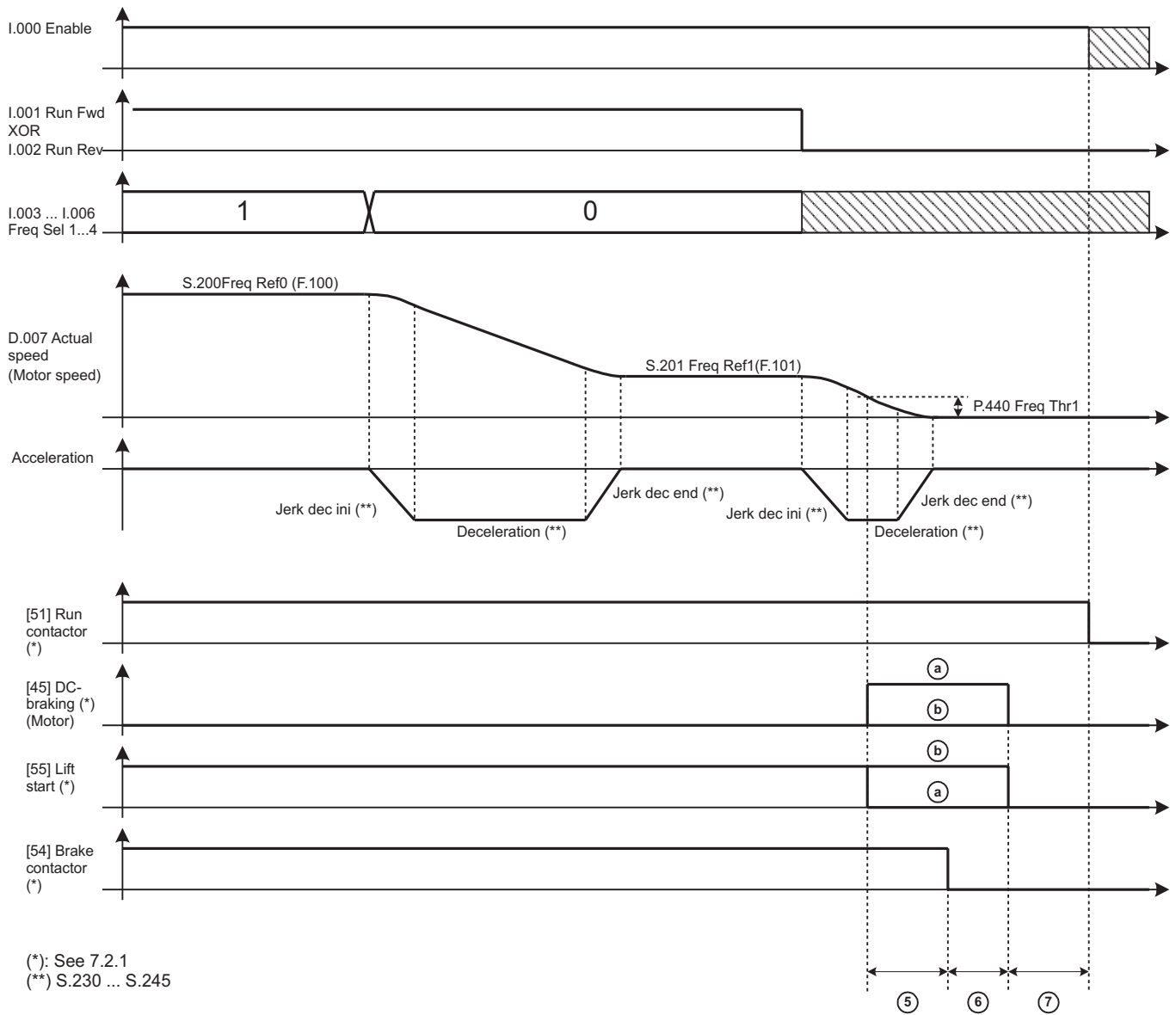

Fig. 7.3 – Detailed stopping sequence

- a) S.260 Lift Stop Mode = [0] DC brake at stop
- b) **S.260 Lift Stop Mode = [1] Normal stop (Default)**

7.2.1 Lift-dedicated digital output functions

Several specific functions can be programmed on the drive digital outputs, in order to check the correctness of the lift sequence and to improve the interaction with the external sequencer. Here follows a list of the functions that can be useful in lift applications.

DO Programming code	Function description
[0] Drive ready	TRUE when the drive is ready to accept a valid RUN command. Meaning that the drive is not in alarm, the dc-link pre-charge is completed and the safe-start interlock logic is cleared.
[1] Alarm state	TRUE when the drive is in alarm status. Alarm reset is needed to restore operation
[2] Not in alarm	TRUE when the drive is not in Alarm status.
[3] Motor run	TRUE when the inverter output bridge is enabled and operating.
[4] Motor stop	TRUE when the inverter output bridge is not operating (all six switches are open).
[5] Rev rotation	TRUE when the motor is rotating counter-clockwise.
[31] Freq > thr1	TRUE when the motor speed (measured or estimated) is above the threshold defined by parameters P.440 and P.441.
[32] Freq < thr1	TRUE when the motor speed (measured or estimated) is below the threshold defined by parameters P.440 and P.441. This function is normally used to detect zero speed (see sequence in Fig.7.2).
[45] DC braking	TRUE when DC injection is in progress.

[51] Contactor	TRUE when the Run contactor has to be closed, either for upward or downward motion.
[52] Contactor UP	TRUE when the Run contactor for upward motion has to be closed.
[53] Contactor DOWN	TRUE when the Run contactor for downward motion has to be closed.
[54] Brake cont	TRUE when the mechanical brake has to be released.
[55] Lift start	TRUE when the inverter output bridge is operating and no DC injection is being operated.
[78] Timer 1 out	TRUE when the Timer function output is 1.

7.2.2 Speed indication

At power-on the drive keypad shows the speed of the lift car (parameter **d.007**), expressed in mm/s. Likewise, all the variables related to the speed of the motor (**d.008**, **d.302**) are expressed in mm/s. The conversion between electrical Hz and car speed is automatically performed by the drive, as explained in the following chapter. The conversion ratio can also be overwritten by the user, by setting parameter **P.600**.

The parameter to be shown at power-on can be configured by setting the parameter **P.580**.

7.3 Ramp Function

Four independent jerks are available for each profile, together with linear acceleration and deceleration times. All profile parameters are expressed in terms of car linear quantities. The equivalence between car speed v (m/s) and inverter output frequency f (Hz) is automatically performed by the drive, based on the value of the following parameters:

- f_b : **S.101 Base frequency** (Hz)
- v_N : **S.180 Car max speed** (m/s)

The ramp profile is shown in Fig.6. Profile number 1 has been used as an example, but the same applies to all the four available profiles. The increase or decrease of the jerk values causes the increase or decrease of the running comfort.

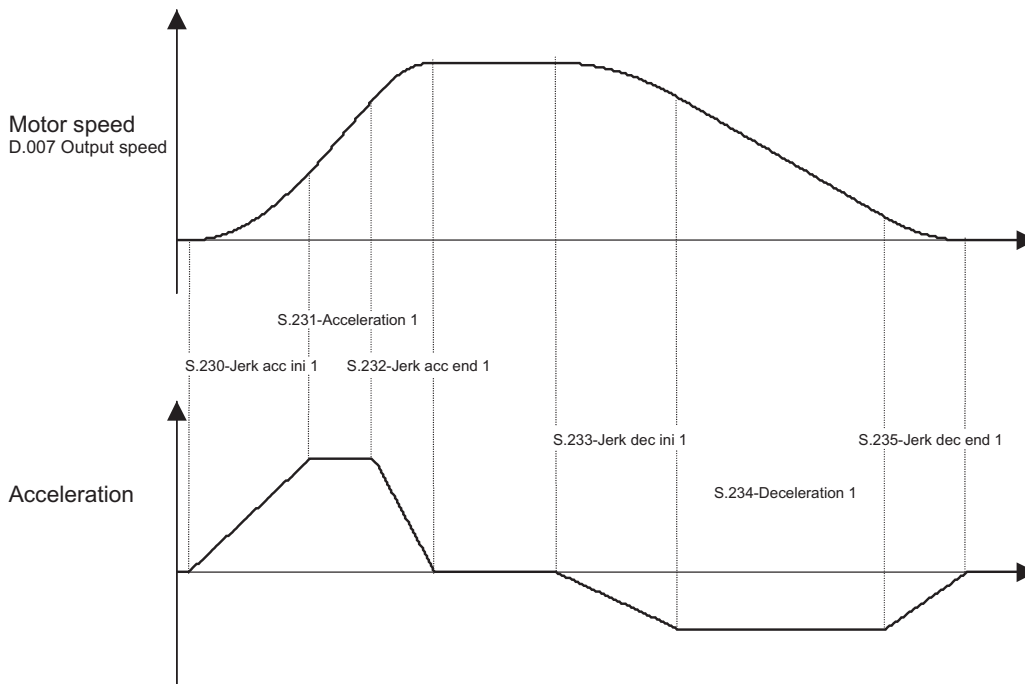

Fig.7.4 – Lift ramp profile

7.3.1 Space calculation and acceleration / deceleration ramps settings

The space covered by the lift car during acceleration and deceleration ramps can be calculated off-line by the drive, by executing the command: **C.060 Calculate space**. The results of the calculation can be monitored into the parameters:

- d.500 Lift space** space covered by the lift car (expressed in meters) when accelerating from zero to the maximum speed (defined by **S.180**) and then immediately decelerating back to zero (one floor travel)
- d.501 Lift accel space** space covered by the lift car (expressed in meters) when accelerating from zero to the maximum speed (defined by **S.180**).
- d.502 Lift decel space** space covered by the lift car (expressed in meters) when decelerating from the maximum speed (defined by **S.180**) to zero.

Knowing the space needed to accelerate and decelerate the lift car with the ramp set in use, is useful to determine whether the ramps are compatible with the position of the floor sensors before actually starting the drive. For example,

if the deceleration ramp is too slow, as compared to the re-aligning distance, the lift car could stop after the floor level. If acceleration and/or deceleration ramps are too fast, the drive may reach the output current limit. In this case, the drive will automatically clamp the current to a safe value, with a resulting loss of output torque. If the drive remains in limit condition for the time specified by the parameter **P.181 - Clamp alm HldOff** (default setting is 1 second), an alarm will be issued (“LF - Limiter fault”) and the lift sequence will be aborted. It is strongly recommended not to operate the drive in current limit, since the desired speed profile cannot be achieved in that case, resulting in undesired oscillations. If the drive reaches the current limit during the acceleration or deceleration phases, it is advised to slow down the ramps, until the limit condition is avoided.

7.3.2 Short Floor Function

Sometimes, the space between adjacent floors is not constant, and there is one floor that may be nearer to the next one. That situation is normally referred as “**Short Floor**”. It could happen that due to the reduced distance, the lift is required to decelerate to the leveling speed, when the acceleration ramp to normal speed is still in progress. This will lengthen the approaching phase, unless countermeasures are taken.

The drive is able to detect a Short Floor, by looking at the sequence.

The flag “**ShortFloorFl**” is set if the deceleration command is given during the acceleration phase.

I.007 Ramp sel 1 src = “[25] ShortFloorFl”

The flag is reset when the stop command is given, or when the sequence is aborted.

“**ShortFloorFl**” is default used to control the short floor, using the second set of ramps.

The regulation of the parameters from **S.240** to **S.245** allows to define the area to be covered before reaching the floor. In case of short floor, if the lift overcomes the floor it means that the lift speed was too high and it is therefore necessary to increase the jerk values (parameters **S.242**, **S.243**, **S.244**). If the plant works for a too long time with a low speed before reaching the floor, the jerk values have to be decreased (parameters **S.242**, **S.243**, **S.244**).

A typical short floor sequence is reported in Fig. 7.5 .

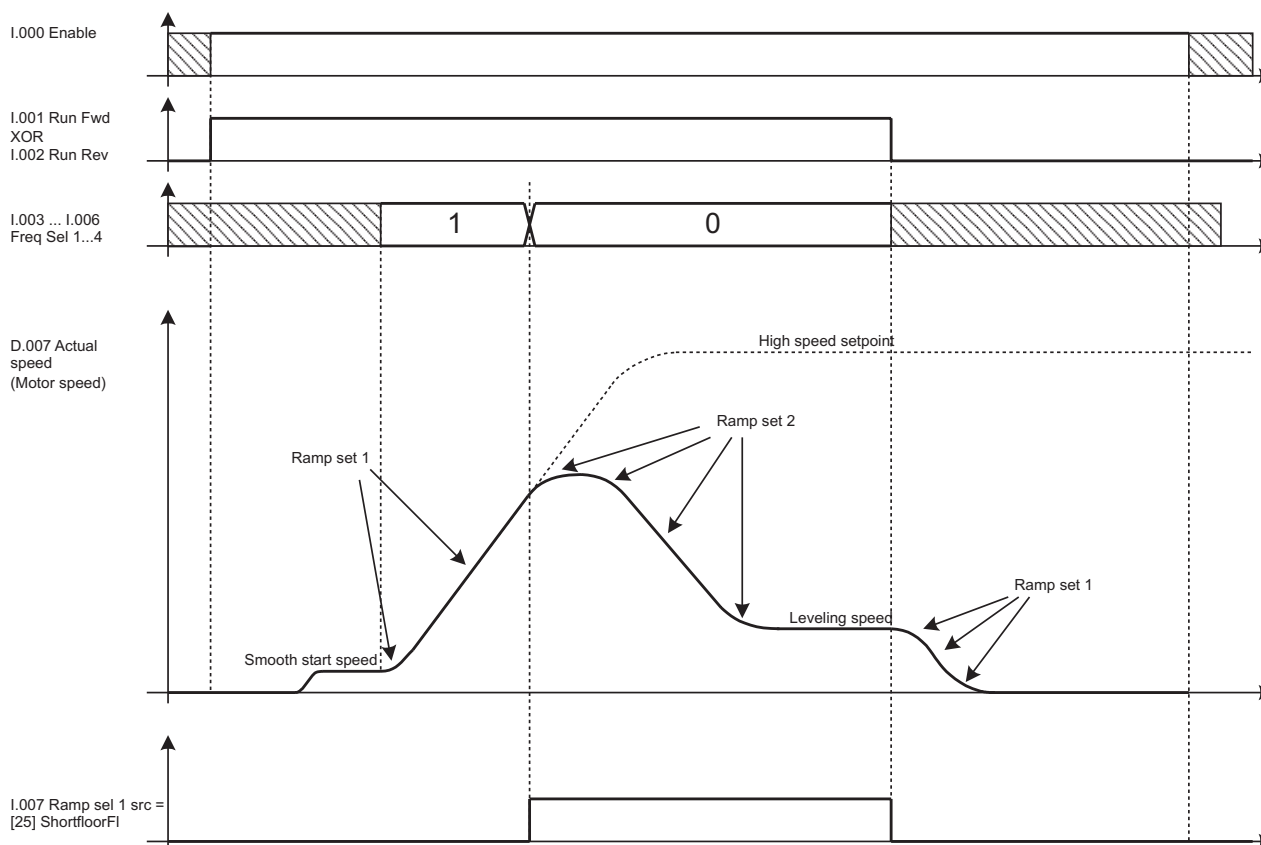

Fig. 7.5 – Short floor sequence

Ramp references:	1	S.240 Jerk acc ini 2	4	S.243 Jerk dec ini 2
	2	S.241 Acceleration 2	5	S.244 Deceleration 2
	3	S.242 Jerk acc end 2	6	S.245 Jerk dec end 2

7.4 Startup Menu

Lift version has parameters that are organized with access levels, as follows:

Access level	Accessible parameters
1	- Basic display parameters - Command for save parameters - P.998
2 (Default)	- All level 1 parameters - Startup parameters - All commands
3	All parameters

The access level is set by the parameter **P.998 Param access lev.**

Note! When using WEG_eXpress, configurator, all parameters are accessible, regardless of what is specified by parameter P.998.

In order to make drive installation easy, all the parameters needed for standard setup are gathered in the **STARTUP** menu. This menu consists of links to parameters present in different drive menus. Therefore, making a change to any of the parameters in Startup, is equivalent to make the same change to the linked parameter in another menu.

The list of parameters in Startup menu of the lift version follows:

Note! (*) = Size dependent
(ALIAS): On STARTUP menu only. Parameter code of same parameter on other menu .

Menu S - Startup

Code	Display (Description)	Def.	Min.	Max
S.000	Mains voltage (linked to P.020) Nominal voltage (Vrms) of the AC input mains.	380	230	480
S.001	Mains frequency (linked to P.021) Nominal frequency (Hz) of the AC input mains.	50	50	60
S.100	Base voltage (linked to P.061) Maximum inverter output voltage (Vrms). It should be set to motor rated voltage, as shown on the nameplate.	380	50	528
S.101	Base frequency (linked to P.062) Motor base frequency (Hz). It is the frequency at which the output voltage reaches the motor rated (data on motor nameplate).	50	25	500
S.150	Motor rated curr (linked to P.040) Motor rated current (Arms). It should be set according to motor nameplate.	(*)	(*)	(*)
S.151	Motor pole pairs (linked to P.041) Number of pole pairs of the motor (data on motor nameplate).	2	1	60
S.152	Motor power fact (linked to P.042) Motor input power factor at rated current and rated voltage. It should be set according to nameplate.	(*)	(*)	(*)
S.153	Motor stator R (linked to P.043) Equivalent resistance of the motor stator windings (Ohm). This value is important for correct operation of the automatic boost, and slip compensation functions. It should be set to half of the resistance measured between two of the motor input terminals, with the third terminal open. If unknown, it can be automatically measured by the autotuning command (see S.170).	(*)	(*)	(*)
S.170	Measure stator R (linked to C.100) The execution of this command allows the user to measure the equivalent stator resistance of the motor in use. After the command is issued, it is necessary to initiate a standard run sequence, by giving enable and start commands. The inverter will close the run contactor, but will not release the brake, allowing for current to flow in the windings. After the procedure is successfully completed, the value of S.153 is automatically updated.	0.50	0.01	5.00

S.180	Car max speed	(linked to A.090)	0.50	0.01	5.00
	Speed of the lift car (m/s) when the inverter outputs the rated frequency.				
S.200	Frequency ref 0	(linked to F.100)	10.0	-F.020	F.020
	See description of S.207.				
S.201	Frequency ref 1	(linked to F.101)	50.0	-F.020	F.020
	See description of S.207.				
S.202	Frequency ref 2	(linked to F.102)			
S.203	Frequency ref 3	(linked to F.103)			
S.204	Frequency ref 4	(linked to F.104)			
S.205	Frequency ref 5	(linked to F.105)			
S.206	Frequency ref 6	(linked to F.106)			
S.207	Frequency ref 7	(linked to F.107)	0.0	-F.020	F.020
	Frequency references (Hz) of the inverter. The selection of any of the above references is performed by the dedicated selectors (Freq Sel 0 to 4). Although only 8 references are present in the startup menu, it is possible to use up to 16 different references, available in the menu F.				
S.220	Smooth start frq	(linked to F.116)	2.0	-F.020	F.020
	Frequency reference (Hz) used during the smooth start procedure.				
S.225	Ramp factor 1	(linked to A.091)	1.00	0.01	2.50
	Ramp accel/decel and jerks are defined by the parameters described below. However, for an easy setting, it is possible to use a common extension factor to speed-up or slow down the ramps. For example, if S.225 is set to 0.5, all the parameters related to the sets 1 and 3 of ramps (accels, decels and jerks) are halved, resulting in slower ramps.				
S.226	Ramp factor 2	(linked to A.092)	1.00	0.01	2.50
	Same as S.225, but it applies to the ramp sets 2 and 4.				
S.230	Jerk acc ini 1	(linked to F.251)	0.50	0.01	10.00
	Jerk (m/s^3) applied at the beginning of an acceleration with ramp set 1 (Ramp set 1 is the one used by default, during normal operation).				
S.231	Acceleration 1	(linked to F.201)	0.60	0.01	5.00
	Linear acceleration (m/s^2) with ramp set 1.				
S.232	Jerk acc end 1	(linked to F.252)	1.40	0.01	10.00
	Jerk (m/s^3) applied at the end of an acceleration with ramp set 1.				
S.233	Jerk dec ini 1	(linked to F.253)	1.40	0.01	10.00
	Jerk (m/s^3) applied at the beginning of a deceleration with ramp set 1.				
S.234	Deceleration 1	(linked to F.202)	0.60	0.01	5.00
	Linear deceleration (m/s^2) with ramp set 1.				
S.235	Jerk dec end 1	(linked to F.254)	1.00	0.01	10.00
	Jerk (m/s^3) applied at the beginning of a deceleration with ramp set 1.				
S.240	Jerk acc ini 2	(linked to F.255)	0.50	0.01	10.00
	Jerk (m/s^3) applied at the beginning of an acceleration with ramp set 2 (Ramp set 2 is the one used by default when a short floor is detected).				
S.241	Acceleration 2	(linked to F.203)	0.60	0.01	5.00
	Linear acceleration (m/s^2) with ramp set 2.				
S.242	Jerk acc end 2	(linked to F.256)	1.40	0.01	10.00
	Jerk (m/s^3) applied at the beginning of a deceleration with ramp set 2.				
S.243	Jerk dec ini 2	(linked to F.257)	1.40	0.01	10.00
	Jerk (m/s^3) applied at the beginning of a deceleration with ramp set 2.				
S.244	Deceleration 2	(linked to F.204)	0.60	0.01	5.00

Linear deceleration (m/s²) with ramp set 2.

S.245	Jerk dec end 2	(linked to F.258)	1.00	0.01	10.00
	Jerk (m/s ³) applied at the beginning of a deceleration with ramp set 2.				
S.250	Cont close delay	(linked to A.080)	0.20	0.00	10.00
	Delay time (s) for safe closing or the run contactor.				
S.251	Magnet time	(linked to A.081)	1.00	0.00	10.00
	Duration (s) of the initial magnetization of the motor with DC injection.				
S.252	Brake open delay	(linked to A.082)	0.20	0.00	10.00
	Delay time (s) between the open command and effective opening of the mechanical brake.				
S.253	Smooth start dly	(linked to A.083)	0.00	0.00	10.00
	Duration (s) of the smooth start phase.				
S.254	DCBrake stp time	(linked to A.084)	1.00	0.00	10.00
	Duration (s) of the stopping phase, after the speed has fallen below the zero threshold (defined by parameter P.440). During this phase, the inverter can either output a DC current, or maintain a low frequency, in order to compensate for the slip (default), as programmed by S.260.				
S.255	Brake close dly	(linked to A.085)	0.20	0.00	10.00
	Delay time (s) between the close command and the effective engagement of the mechanical brake.				
S.256	Cont open delay	(linked to A.086)	0.20	0.00	10.00
	Delay time (s) between the open command and the affective opening of the run contactor.				
S.260	Lift stop mode	(linked to A.220)	[1] Normal stop		
	After the car speed falls below the zero threshold (defined by P.440), the inverter can be programmed to brake with DC injection (S.260 = 0), or to maintain a low frequency output in order to compensate for the estimated slip (S.260 = 1). The latter is set by default.				
	Possible selections:	[0] DC brake at stop [1] Normal stop			
S.300	Manual boost [%]	(linked to P.120)	3.0	0.0	25.0
	Voltage boost (% of motor rated voltage) applied at low frequency in order to maintain the machine flux.				
S.301	Auto boost en	(linked to P.122)	[0] Disable		
	The automatic boost allows for precise compensation of the resistive voltage drop due to the winding resistance, keeping the flux at its rated value regardless of the load level and output frequency. For correct operation of this function, a precise value of the equivalent stator resistance is needed.				
	Possible selections:	[0] Disable [1] Enable			
S.310	Slip compensat	(linked to P.100)	50	0	250
	Amount of slip compensation (% of rated slip, calculated from nameplates) during motoring (power flows from motor to load).				
S.311	Slip comp regen	(linked to P.102)	50	0	250
	Amount of slip compensation (% of rated slip, calculated from nameplates) during regeneration (power flows back from load to motor).				
S.312	Slip comp filter	(linked to P.101)	0.3	0.0	10.0
	Time constant (s) of the filter used for slip compensation. The lower this value, the faster the compensation, with improved speed control. Excessively fast slip compensation may cause unwanted oscillations.				
S.320	DC braking level	(linked to P.300)	75	0	100
	Amount of current (% of drive rated current) injected during magnetization and stopping phases.				
S.400	Control mode	(linked to P.010)	[0] V/f OpenLoop		
	Set this parameter to "[0] Open loop V/f" when there is no encoder feedback available.				
	Set to "[1] Closed loop V/f" otherwise.				
	Possible selections:	[0] V/f OpenLoop [1] V/f ClsdLoop			

S.401	Encoder ppr	(linked to I.501)	1024	1	9999
	Resolution of the encoder in use, expressed in number of pulses per mechanical revolution (ppr). It is a nameplate data of the encoder.				
S.450	Spd ctrl P-gainH	(linked to P.172)	2.0	0.0	100.0
	Proportional gain of speed PI regulator.				
S.451	Spd ctrl I-gainH	(linked to P.173)	1.0	0.0	100.0
	Integral gain of speed PI regulator.				
S.452	Spd PI High lim	(linked to P.176)	10.0	0.0	100.0
	Maximum allowed output of the speed PI regulator (% of maximum frequency, F.020). It represents the maximum amount of slip that is allowed during motoring operation.				
S.453	Spd PI Low lim	(linked to P.177)	-10.0	-100.0	0.0
	Minimum allowed output of the speed PI regulator (% of maximum frequency, F.020). It represents the maximum amount of slip (negative) that is allowed during braking operation.				

Note! It is possible to configure gain scheduling for the speed PI regulator.

S.901	Save parameters	(linked to C.000)			
	The execution of this command will save all the parameters into the permanent memory of the drive. All unsaved settings will be lost if the power is cycled.				

7.5 Menù Display

d.000	Output frequency	Drive output frequency	Hz	0.01	001
d.001	Frequency ref	Drive frequency reference	Hz	0.01	002
d.002	Output current	Drive output current (rms)	A	0.1	003
d.003	Output voltage	Drive output voltage (rms)	V	1	004
d.004	DC link voltage	DC Bus drive voltage (DC)	V	1	005
d.005	Power factor	Power factor		0.01	006
d.006	Power [kW]	Inverter output power	kW	0.01	007
d.007	Output speed	Drive output speed	mm/s	1	008
d.008	Speed ref	Drive speed reference (d.001)*(P.600)	mm/s	1	009
d.050	Heatsink temp	Drive heatsink temperature (linear sensor measured)	°C	1	010
d.051	Drive OL	Drive overload (100% = alarm threshold)	%	0.1	011
d.052	Motor OL	Motor overload (100% = alarm threshold)	%	0.1	012
d.053	Brake res OL	Braking resistor overload (100%=alarm thr)	%	0.1	013
d.100	Dig inp status	Digital inputs status acquired by the drive (terminal or virtual)			014
d.101	Term inp status	Digital inputs terminal status of the drive regulat. Board			015
d.102	Vir dig inp stat	Virtual digital inputs status from drive serial link			016
d.120	Exp dig inp stat	Expansion digital inputs status (optional terminal or virtual)			017
d.121	Exp term inp	Expansion digital inputs terminal status of the drive expansion board			018
d.122	Vir exp dig inp	Expansion virtual digital inputs status from drive serial link			019
d.150	Dig out status	Digital outputs status on the terminals of the drive regulation board (commanded by DO functions or virtual DO)			020
d.151	Drv dig out sta	Digital outputs status, commanded by DO functions			021
d.152	Vir dig out sta	Virtual digital outputs status, commanded via serial link			022
d.170	Exp dig out sta	Expansion digital outputs status on the terminals of the drive regulation board (commanded by DO functions or virtual DO)			023
d.171	Exp DrvDigOutSta	Expansion digital outputs status, commanded by DO functions			024
d.172	Exp VirDigOutSta	Expansion virtual digital outputs status (commanded via serial link)			025
d.200	An in 1 cnf mon	Analog input 1 destination; it shows the function associated to this analog input [0] Null funct [1] Rif freq 1 [2] Rif freq 2 [3] Fatt liv Bst [4] Fatt liv OT [5] FattLiv Vred [6] Fatt liv DCB [7] FattEst Ramp [8] FattRif freq [9] VelPI LimFac [10] MltFrq ch 1 [11] MltFrq ch 2			026
d.201	An in 1 monitor	Analog input 1 output block % value			027
d.202	An in 1 term mon	Analog input 1 input block % value			028
d.210	Reserved				029
d.211	Reserved				030
d.212	Reserved				031

d.220	Reserved				032
d.221	Reserved				033
d.222	Reserved				034
d.250	LCW To PLC (0-7)	Monitor of the control bits sent to the internal sequencer. Bit 0 to 7			66
d.251	LCW To PLC(8-15)	Monitor of the control bits sent to the internal sequencer. Bit 8 to 15			67
d.252	LCW Fr PLC (0-7)	Monitor of the control bits generated by the internal sequencer. Bit 0 to 7			68
d.253	LCW Fr PLC(8-15)	Monitor of the control bits generated by the internal sequencer. Bit 8 to 15			69
d.254	LCW FrPLC(16-23)	Monitor of the control bits generated by the internal sequencer. Bit 16 to 23			70
d.255	LSW (0-7)	Monitor of the drive status. Bit 0 to 7.			71
d.300	EncPulses/Sample	Number of encoder pulses, recorded in the time interval defined by parameter I.504.		1/100	035
d.301	Encoder freq	Encoder frequency reading (Motor frequency)	Hz	0.01	036
d.302	Encoder speed	Encoder speed reading (d.000)*(P.600)		0.01/1	037
d.350	Reserved				
d.351	Reserved				
d.353	Reserved				
d.354	Reserved				
d.400	PID reference	PID reference signal	%	0.1	041
d.401	PID feedback	PID feedback signal	%	0.1	042
d.402	PID error	PID error signal	%	0.1	043
d.403	PID integr comp	PID integral component	%	0.1	044
d.404	PID output	PID output signal	%	0.1	045
d.450	Mdplc error	Status of internal sequencer 0 No error 1 Internal sequencer error			62
d.500	Lift space	Space needed to accelerate the car from zero to max speed and then decelerate back to zero	m	0.01	63
d.501	Lift space	Space needed to accelerate the car from zero to max speed			
d.502	Lift space	Space needed to decelerate the car from max speed to zero	m	0.01	65
d.800	1st alarm-latest	Last alarm stored by the drive alarm list See par. 10.3			046
d.801	2nd alarm	Second to last alarm			047
d.802	3rd alarm	Third to last alarm			048
d.803	4th alarm	Fourth to last alarm			049
d.950	Drive rated curr	Drive rated current (it depends on the drive size)		0.1	050
d.951	SW version (1/2)	Software version - part 1 (03.01)		0.01	051
d.952	SW version (2/2)	Software version - part 2 (00.00)		0.01	052
d.957	Drive size	Drive size code 7 4kW - 400/460V 8 5.5kW - 400/460V 9 7.5kW - 400/460V			057
d.958	Drive cfg type	Drive configuration type [0]Standard: 400Vac, 50Hz [1] American: 460Vac, 60Hz			061
d.999	Display Test	Drive display test			

7.6 Timer 1 function (from fw 03.07)

The timer function allows to apply delays and pulses to an input signal selected from a pick list.

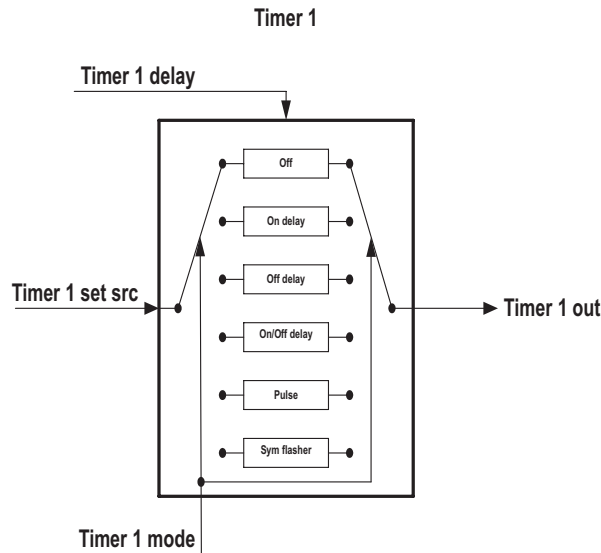

Menu A - APPLICATION

Cod.	Display (Description)	Def.	Min.	Max
A.320	Timer 1 mode	0	0	5

Select working mode of Timer 1

- [0] Disable
- [1] On delay
- [2] Off delay
- [3] On/Off delay
- [4] Pulse
- [5] Sym flasher

[0] Disable Output is always Off

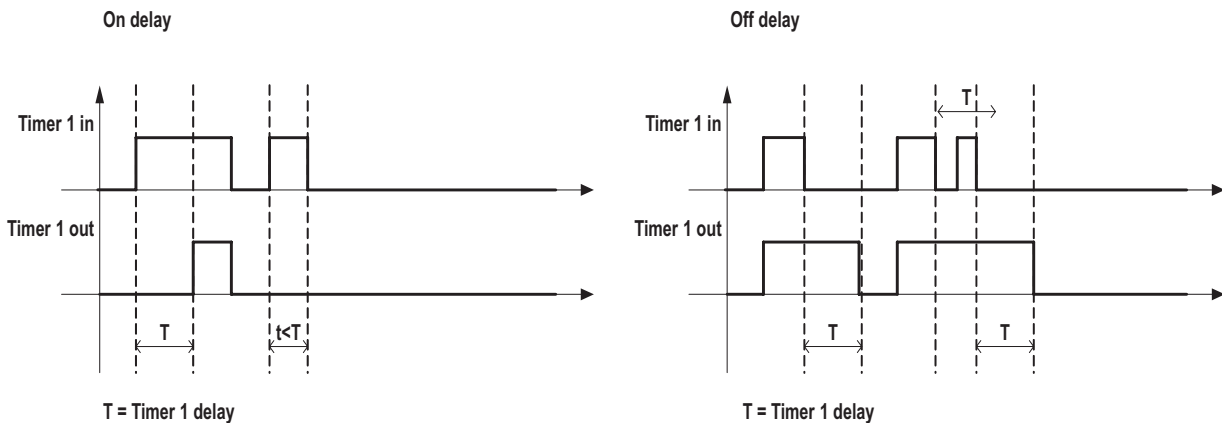

[1] On delay The closure of the Input (On) is transferred on Output after pre-set time has elapsed.

[2] Off delay The closure of the Input (On) is transferred immediately on the Output.
The opening of the Input (Off) initiates the pre-set delay, after which the Output is reset (Off).

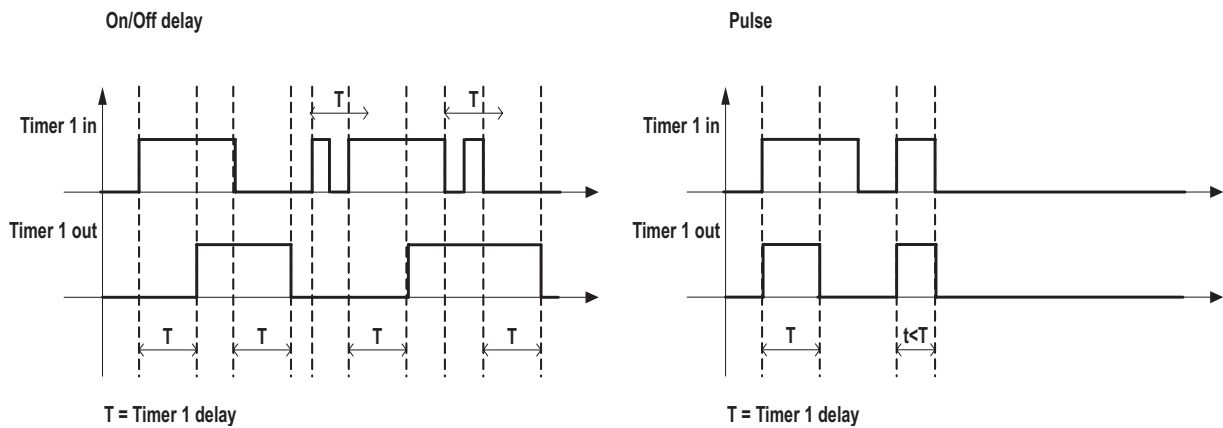

[3] On/Off delay The closure of the Input (On) is transferred on Output after pre-set time has elapsed.
 The opening of the Input (Off) initiates the pre-set delay, after which the Output is reset (Off).

[4] Pulse The closure of the Input (On) is transferred immediately on the Output.
 After pre-set time has elapsed, the Output reset (Off).

Symmetrical flasher

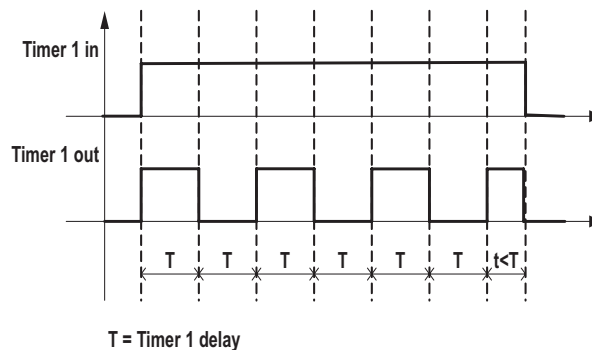

[5] Sym flasher The closure of the Input (On) is transferred immediately on the Output.
 The Output cycle between On and Off for as long as Input is close (On).
 The ratio is 1:1 (time On = time Off)

A.321 Timer 1 set src	0	0	27
Select input signal of Timer 1. See list of I.000			
A.322 Timer 1 delay	3.00	0.00	30.00
Set delay of Timer 1. See list of I.000			

Example of Timer 1 use:

The default configuration of I.100 "Dig output 1 cfg" is [51] "Contactor".
 For the needs of external sequences is necessary to delay of 3 sec the rising edge.
 You can get this behaviour with the Timer 1.

- The necessary configurations are:
 A.320 **Timer 1 mode** = [1] On delay
 A.321 **Timer 1 set src** = [26] Contactor
 A.322 **Timer 1 delay** = 3.0 sec
 I.100 **Dig output 1 cfg** = [78] Timer 1 out

8 - Troubleshooting

8.1 Drive Alarm Condition

The drive keypad will show a blinking message with code and name of the alarm occurred. The figure below shows an example of **OV Overvoltage** alarm condition.

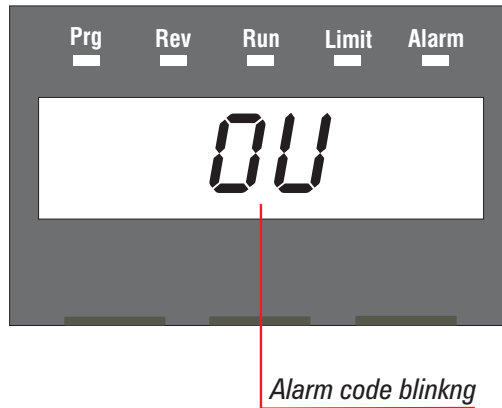

Figure 8.1.1: Alarm Displaying

The active alarm can be acknowledged by pressing the **Prg** button on the keypad. This operation will allow **menu navigation and parameter editing** while the drive is in alarm state (red LEDs blinking). In order to resume drive operation, an Alarm reset command is necessary.

8.2 Alarm Reset

Alarm reset can be performed in three different ways:

- *Alarm reset by keypad:*

pressing simultaneously **Up** and **Down** keys; the reset action will take effect when the buttons are released.

- *Alarm reset by digital input:*

it can be performed through a programmable digital input connected to command **I.010 Fault reset src = [6] Digital input 5**.

. *Alarm reset by Autoreset function:*

it allows an automatic reset of some drive alarms (see table 8.3.1), by the settings of **P.380, P.381, P.382** and **P.383** parameters.

The figure below shows how to reset an alarm by keypad.

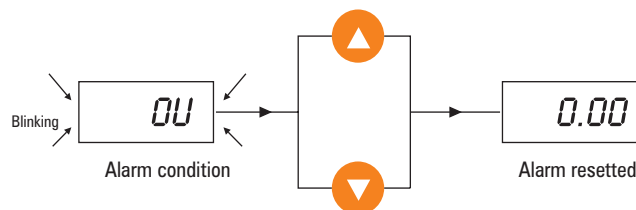

Figure 8.2.1: Alarm Reset

8.3 List of drive alarm events

Table 8.3.1 provides a description of the causes for all the possible alarms.

Table 8.3.1 Alarm event list

ALARM		DESCRIPTION	Numerical code from serial	Autoreset	Bit H.062 H.063
Cod.	Name				
EF	EF Ext Fault	It trips when External fault input is active	1	YES	0
OC	OC OverCurrent	It trips when an Overcurrent value is detected by output current sensor	2	YES	1
OU	OV OverVoltage	It trips when the drive DC Bus voltage is higher than the maximum threshold for the given main voltage setting	3	YES	2
UU	UV UnderVoltage	It trips when the drive DC Bus voltage is lower than the maximum threshold for the given main voltage setting	4	YES	3
OH	OH OverTemperat	It trips when the drive heatsink temperature detected by the switch sensor exceeds its threshold (*)	5	NO	4
OLi	OLi Drive OL	It trips when the drive overload accumulator exceeded the trip threshold	6	NO	5
OLM	OLM Motor OL	It trips when the motor overload accumulator exceeded the trip threshold	7	NO	6
OLr	OLr Brake res OL	Its intervention occurs when the overload cycle of the external braking resistance does not correspond to the defined limits.	8	NO	7
Ot	Ot Inst OverTrq	It trips when the torque delivered by the motor exceeds the programmed level for the preset time	9	NO	8
PH	PH Phase loss	It trips when the supply phase lack: enabled 30 seconds after one of the supply phases has been disconnected	10	NO	9
FU	FU Fuse Blown	It trips when the drive input fuses are blown	11	NO	10
OCH	OCH Desat Alarm	IGBT desaturation or instantaneous overcurrent have been detected	12	YES	11
St	St Serial TO	It trips when the serial link time out exceeds the programmed level (I.604 parameter)	13	YES	12
OP1		Reserved	14	NO	13
OP2		Reserved	15	NO	14
bF	bF Bus Fault	Drive communication Bus failure	16	NO	15
OHS	OHS OverTemperat	It trips when the drive heatsink temperature exceeds a safety level. (*)	17	NO	16
SHC	SHC Short Circ	Short Circuit between output phases or Ground fault	18	NO	17
Ohr		Riservato	19		18
Lf	LF Limiter fault	It trips when the output current limiter or the DC-Link voltage limiter fail. The failure can be caused by wrong settings of regulator gains or by the motor load.	20	NO	19
PLC	PLC Plc fault	"PLC program not active. Lift application does not function. Run C.050 parameter to reset the alarm."	21	NO	20
EMS	Key Em Stp fault	Reserved	22	NO	21
UHS	UHS Under Temperat	It trips when the temperature of the drive heatsink is below a safety level (typically -10°C).	23	NO	22
PHO	Phase Loss Output	See figure 7.2: it trips during the phase (2) if the current does not exceed the limit defined	25	NO	24

*) OH switch sensor threshold and OHS analog sensor threshold depend on the drive size (75 °C ... 85 °C)

9 - Parameter list

Figure 9.1: Parameters Description Legend

Code (A)	PARAMETER		PICK LIST		Def. (D)	Min (E)	Max (F)	Unit (G)	Variat. (H)	IPA (I)
	Name (B)	DESCRIPTION	Selection (C)	Description						
START-UP										
S.000	Mains voltage	Rated value of the line voltage	230 380 400 420 440 460 480		400	230	480	V		404 (P.020)
S.001	Mains frequency	Rated value of the line frequency	50 60		50	50	60	Hz		405 (P.021)

(A) CODE: Parameter Code, showed on display.
Format=X.YYY:

X=Menu

d=DISPLAY

S=STARTUP

I=INTERFACE

F=FREQ & RAMPS

P=PARAMETER

A=APPLICATION

C=COMMAND

H=HIDDEN

YYY = Parameter number

(B) Parameter name

(C) Selection list, code [IN BRAKET]

(D) Parameter default value

(E) Parameter minimum value

(F) Parameter maximum value

(G) Parameter unit of measure

(H) Parameter step of variation

(I) Parameter sw number, used via serial
If IPA bold= not writable parameter with running motor

Note! (ALIAS): On STARTUP menu only.
Parameter code of same parameter on other menu .

(*): Parameter value depends on the drive size.

Code	PARAMETER		PICK LIST		Def.	Min	Max	Unit	Variat.	IPA
	Name	DESCRIPTION	Selection	Description						
DISPLAY										
d.000	Output frequency	Drive output frequency						Hz	0.01	001
d.001	Frequency ref	Drive frequency reference						Hz	0.01	002
d.002	Output current	Drive output current (rms)						A	0.1	003
d.003	Output voltage	Drive output voltage (rms)						V	1	004
d.004	DC link voltage	DC Bus drive voltage (DC)						V	1	005
d.005	Power factor	Power factor							0.01	006
d.006	Power [kW]	Inverter output power						kW	0.01	007
d.007	Output speed	Drive output speed						mm/s	1	008
d.008	Speed ref	Drive speed reference (d.001)*(P.600)						mm/s	1	009
d.050	Heatsink temp	Drive heatsink temperature (linear sensor measured)						°C	1	010
d.051	Drive OL	Drive overload (100% = alarm threshold)						%	0.1	011
d.052	Motor OL	Motor overload (100% = alarm threshold)						%	0.1	012
d.053	Brake res OL	Braking resistor overload (100%=alarm thr)						%	0.1	013
d.100	Dig inp status	Digital inputs status acquired by the drive (terminal or virtual)								014
d.101	Term inp status	Digital inputs terminal status of the drive regulat. Board								015
d.102	Vir dig inp stat	Virtual digital inputs status from drive serial link								016
d.120	Exp dig inp stat	Expansion digital inputs status (optional terminal or virtual)								017
d.121	Exp term inp	Expansion digital inputs terminal status of the drive expansion board								018
d.122	Vir exp dig inp	Expansion virtual digital inputs status from drive serial link								019
d.150	Dig out status	Digital outputs status on the terminals of the drive regulation board (commanded by DO functions or virtual DO)								020
d.151	Drv dig out sta	Digital outputs status, commanded by DO functions								021
d.152	Vir dig out sta	Virtual digital outputs status, commanded via serial link								022
d.170	Exp dig out sta	Expansion digital outputs status on the terminals of the drive regulation board (commanded by DO functions or virtual DO)								023
d.171	Exp DrvDigOutSta	Expansion digital outputs status, commanded by DO functions								024
d.172	Exp VirDigOutSta	Expansion virtual digital outputs status, commanded via serial link								025
d.200	An in 1 cnf mon	Analog input 1 destination; it shows the function associated to this analog input	[0] Null funct [1] Freq ref 1 [2] Freq ref 2 [3] Bst lev fact [4] OT lev fact [5] Vred lev fac [6] DCB lev fact [7] RampExt fact [8] Freq Ref fact [9] SpdPI LimFac [10] MltFrq ch 1 [11] MltFrq ch 2							026
d.201	An in 1 monitor	Analog input 1 output block % value								027
d.202	An in 1 term mon	Analog input 1 input block % value								028

Code	PARAMETER		PICK LIST		Def.	Min	Max	Unit	Variat.	IPA
	Name	DESCRIPTION	Selection	Description						
d.210	Reserved									
d.211	Reserved									
d.212	Reserved									
d.220	Reserved									
d.221	Reserved									
d.222	Reserved									
d.250	LCW To PLC (0-7)	Monitor of the control bits sent to the internal sequencer. Bit 0 to 7								66
d.251	LCW To PLC(8-15)	Monitor of the control bits sent to the internal sequencer. Bit 8 to 15								67
d.252	LCW Fr PLC (0-7)	Monitor of the control bits generated by the internal sequencer. Bit 0 to 7								68
d.253	LCW Fr PLC(8-15)	Monitor of the control bits generated by the internal sequencer. Bit 8 to 15								69
d.254	LCW FrPLC(16-24)	Monitor of the control bits generated by the internal sequencer. Bit 16 to 24								70
d.255	LSW (0-7)	Monitor of the drive status. Bit 0 to 7								71
d.300	EncPulses/Sample	Number of encoder pulses, recorded in the time interval defined by parameter I.504.							1/100	035
d.301	Encoder freq	Encoder frequency reading (Motor frequency)					Hz	0.01		036
d.302	Encoder speed	Encoder speed reading (d.000)*(P.600)						0.01/1		037
d.350	Reserved									
d.351	Reserved									
d.353	Reserved									
d.354	Reserved									
d.400	PID reference	PID reference signal					%	0.1		041
d.401	PID feedback	PID feedback signal					%	0.1		042
d.402	PID error	PID error signal					%	0.1		043
d.403	PID integr comp	PID integral component					%	0.1		044
d.404	PID output	PID output signal					%	0.1		045
d.450	Mdplc error	Status of internal sequencer	0 1	No error Internal sequencer error						62
d.500	Lift space	Space needed to accelerate the car from zero to max speed and then decelerate back to zero					m	0.01		63
d.501	Lift accel space	Space needed to accelerate the car from zero to max speed					m	0.01		64
d.502	Lift decel space	Space needed to decelerate the car from max speed to zero					m	0.01		65
d.800	1st alarm-latest	Last alarm stored by the drive alarm list	See paragraph 9.3							046
d.801	2nd alarm	Second to last alarm								047
d.802	3rd alarm	Third to last alarm								048
d.803	4th alarm	Fourth to last alarm								049
d.950	Drive rated curr	Drive rated current (it depends on the drive size)						0.1		050
d.951	SW version (1/2)	Software version - part 1	03.01					0.01		051
d.952	SW version (2/2)	Software version - part 2	00.00					0.01		052
d.957	Drive size	Drive size code	4 5 6	4kW - 230/400/460V 5.5kW - 230/400/460V 7.5kW - 230/400/460V						057
d.958	Drive cfg type	Drive configuration type	[0]Standard:400 [1]American:460	Standard: 400Vac, 50Hz American: 460Vac, 60Hz						061
d.999	Display Test	Drive display test								099

Code	PARAMETER		PICK LIST		Def.	Min	Max	Unit	Variat.	IPA
	Name	DESCRIPTION	Selection	Description						
START-UP										
S.000	Mains voltage	Rated value of the line voltage	230 380 400 420 440 460 480		400	230	480	V		404 (P.020)
S.001	Mains frequency	Rated value of the line frequency	50 60		50	50	60	Hz		405 (P.021)
S.100	Base voltage	Motor base (rated) voltage			380	50	528	V	1	413 (P.061)
S.101	Base frequency	Rated frequency of the motor			50	25	250	Hz	0.1	414 (P.062)
S.150	Motor rated curr	Rated current of the motor			(*)	(*)	(*)	A	0.1	406 (P.040)
S.151	Motor pole pairs	Pole Pairs of the motor			2	1	60		0.01	407 (P.041)
S.152	Motor power fact	Motor power factor			(*)	0.01	1		0.01	408 (P.042)
S.153	Motor stator R	Measurement of the stator resistance of the motor			(*)	0	99.99	ohm		409 (P.043)
S.170	Measure stator R	Motor Autotune command	Off do		(1)	(1)	(2)			806 (C.100)
S.180	Car max speed	Speed of the lift car when the inverter output frequency is equal to S.101			0.50	0.01	5.00	m/s	0.01	1323 (A.090)
S.200	Frequency ref 0	Digital reference frequency 0			10.0	-F.020	F.020			311 (F.100)
S.201	Frequency ref 1	Digital reference frequency 1			50.0	-F.020	F.020			312 (F.101)
S.202	Frequency ref 2	Digital reference frequency 2			0	-F.020	F.020			313 (F.102)
S.203	Frequency ref 3	Digital reference frequency 3			0	-F.020	F.020			314 (F.103)
S.204	Frequency ref 4	Digital reference frequency 4			0	-F.020	F.020			315 (F.104)
S.205	Frequency ref 5	Digital reference frequency 5			0	-F.020	F.020			316 (F.105)
S.206	Frequency ref 6	Digital reference frequency 6			0	-F.020	F.020			317 (F.106)
S.207	Frequency ref 7	Digital reference frequency 7			0	-F.020	F.020			318 (F.107)
S.220	Smooth start frq	Frequency reference during smooth start			2.0	-F.020	F.020			327 (F.116)
S.225	Ramp factor 1	Multiplier for acc/dec and jerks of ramp sets 1 and 3			1.00	0.01	2.50		0.01	1324 (A.091)
S.226	Ramp factor 2	Multiplier for acc/dec and jerks of ramp sets 2 and 4			1.00	0.01	2.50		0.01	1327 (A.092)
S.230	Jerk acc ini 1	Jerk applied at the beginning of an acceleration with ramp set 1			0.50	0.01	10.00	m/s ³	0.01	343 (F.251)
S.231	Acceleration 1	Linear acceleration with ramp set 1			0.60	0.01	5.00	m/s ²	0.01	329 (F.201)
S.232	Jerk acc end 1	Jerk applied at the end of an acceleration with ramp set 1			1.40	0.01	10.00	m/s ³	0.01	344 (F.252)
S.233	Jerk dec ini 1	Jerk applied at the beginning of a deceleration with ramp set 1			1.40	0.01	10.00	m/s ³	0.01	345 (F.253)

Code	PARAMETER		PICK LIST		Def.	Min	Max	Unit	Variat.	IPA
	Name	DESCRIPTION	Selection	Description						
S.234	Deceleration 1	Linear deceleration with ramp set 1			0.60	0.01	5.00	m/s2	0.01	330 (F.202)
S.235	Jerk dec end 1	Jerk applied at the end of a deceleration with ramp set 1			1.00	0.01	10.00	m/s3	0.01	346 (F.254)
S.240	Jerk acc ini 2	Jerk applied at the beginning of an acceleration with ramp set 2			1.00	0.01	10.00	m/s3	0.01	347 (F.255)
S.241	Acceleration 2	Linear acceleration with ramp set 2			0.60	0.01	5.00	m/s2	0.01	331 (F.203)
S.242	Jerk acc end 2	Jerk applied at the end of an acceleration with ramp set 2			1.40	0.01	10.00	m/s3	0.01	348 (F.256)
S.243	Jerk dec ini 2	Jerk applied at the beginning of a deceleration with ramp set 2			1.40	0.01	10.00	m/s3	0.01	349 (F.257)
S.244	Deceleration 2	Linear deceleration with ramp set 2			0.60	0.01	5.00	m/s2	0.01	332 (F.204)
S.245	Jerk dec end 2	Jerk applied at the end of a deceleration with ramp set 2			1.00	0.01	10.00	m/s3	0.01	350 (F.258)
S.250	Cont close delay	RUN contactor close delay			0.20	0	10	s	0.01	1316 (A.080)
S.251	Magnet time	Motor magnetization time			1	0	10	s	0.01	1317 (A.081)
S.252	Brake open delay	Brake contactor open delay			0.20	0	10	s	0.01	1318 (A.082)
S.253	Smooth start dly	Smooth start duration			0	0	10	s	0.01	1319 (A.083)
S.254	DCBrake stp time	Duration of 0Hz braking at stop			1	0	10	s	0.01	1320 (A.084)
S.255	Brake close dly	Brake contactor close delay			0.20	0	10	s	0.01	1321 (A.085)
S.256	Cont open delay	RUN contactor open delay			0.20	0	10	s	0.01	1322 (A.086)
S.260	Lift stop mode	Lift behavior at stop	[0] Dcb at stop [1] Normal stop	DC brake is performed after the output frequency is below P.440 threshold DC brake is not performed at stop	1	0	1			1350 (A.220)
S.300	Manual boost [%]	Manual boost at low revolutions			3.0	0.0	25.0	% of S.100	0.1	421 (P.120)
S.301	Auto boost en	Automatic boost function enabling	[0] Disable [1] Enable		0	0	1			423 (P.122)
S.310	Slip compensat	Amount of slip compensation during motoring			50	0	250	% of rated slip	1	419 (P.100)
S.311	Slip comp regen	Amount of slip compensation during regeneration			50	0	250	% of rated slip	1	500 (P.102)
S.312	Slip comp filter	Time constant of slip compensation			0.3	0	10	s	0.1	420 (P.101)
S.320	DC braking level	Current level used during DC brake at start and stop			75	0	100	% of d.950	1	449 (P.300)
S.400	Control mode	Drive control mode	[0] V/f OpenLoop [1] V/f ClsdLoop	Speed control without encoder feedback Speed control with encoder feedback	0	0	1			498 (P.010)
S.401	Encoder ppr	Pulses per revolution of the encoder in use			1024	1	9999		1	151 (I.501)
S.450	Spd ctrl P-gainL	Speed loop Proportional gain			2.0	0	100	%	0.1	503 (P.172)
S.451	Spd ctrl I-gainL	Speed loop Integral gain			1.0	0	100	%	0.1	504 (P.173)
S.452	Spd PI High lim	Speed PI regulator output upper limit			10	0	100	% of F.020	0.1	509 (P.176)

Code	PARAMETER		PICK LIST		Def.	Min	Max	Unit	Variat.	IPA
	Name	DESCRIPTION	Selection	Description						
S.453	Spd PI Low lim	Speed PI regulator output lower limit			-10	-100	0	% of F.020	0.1	510 (P.177)
S.901	Save parameters	Save parameters	off" do		off"	off"	("do")			800 (C.000)

INTERFACE

I.000	Enable src	Source of the Enable command of Lift Control Word	[0] False	The command is never active	2	0	27			100
			[1] True	The command is always active						
			[2] DI 1	The command comes from DigInp1						
			[3] DI 2	The command comes from DigInp2						
			[4] DI 3	The command comes from DigInp3						
			[5] DI 4	The command comes from DigInp4						
			[6] DI 5	The command comes from DigInp5						
			[7] DI 6	The command comes from DigInp6						
			[8] DI 7	The command comes from DigInp7						
			[9] DI 8	The command comes from DigInp8						
			[10] DI Exp 1	The command comes from ExpDI 1						
			[11] DI Exp 2	The command comes from ExpDI 2						
			[12] DI Exp 3	The command comes from ExpDI 3						
			[13] DI Exp 4	The command comes from ExpDI 4						
			[14] AND 1	The command comes from the output of the block AND1						
			[15] AND 2	The command comes from the output of the block AND2						
			[16] AND 3	The command comes from the output of the block AND3						
			[17] OR 1	The command comes from the output of the block OR1						
			[18] OR 2	The command comes from the output of the block OR2						
			[19] OR 3	The command comes from the output of the block OR3						
			[20] NOT 1	The command comes from the output of the block NOT1						
			[21] NOT 2	The command comes from the output of the block NOT2						
			[22] NOT 3	The command comes from the output of the block NOT3						
			[23] NOT 4	The command comes from the output of the block NOT4						

Code	PARAMETER		PICK LIST		Def.	Min	Max	Unit	Variat.	IPA
	Name	DESCRIPTION	Selection	Description						
			[24] FrqSel match	The command is coming from the output of the block Freq Sel match						
			[25] ShortFloorFl	The command is the short floor flag						
			[26] Contactor (fw 03-07)	Active when the RUN contactor has to be closed, either for upward or downward motion						
			[27] Timer 1 (fw 03-07)	Output of Timer 1						
I.001	Run Fwd src	Source of the Run Forward command of LCW	As for I.000		3	0	27			101
I.002	Run Rev src	Source of the Run Reverse command of LCW	As for I.000		4	0	27			102
I.003	Freq Sel 1 src	Source of the Frequency Selector 1 of LCW	As for I.000		5	0	27			103
I.004	Freq Sel 2 src	Source of the Frequency Selector 2 of LCW	As for I.000		6	0	27			104
I.005	Freq Sel 3 src	Source of the Frequency Selector 3 of LCW	As for I.000		7	0	27			105
I.006	Freq Sel 4 src	Source of the Frequency Selector 4 of LCW	As for I.000		0	0	27			106
I.007	Ramp Sel 1 src	Source of the Ramp Selector 1 of LCW	As for I.000		25	0	27			107
I.008	Ramp Sel 2 src	Source of the Ramp Selector 1 of LCW	As for I.000		0	0	27			108
I.009	Ext fault src	Source of the External Fault command of LCW	As for I.000		8	0	27			109
I.010	Faul reset src	Source of the Fault Reset command of LCW	As for I.000		9	0	27			110
I.011	Bak pwr act src	Source of the Backup Power Supply Active command of LCW	As for I.000		0	0	27			111
I.012	Forced stop src	Source of the Forced Stop command of LCW			0	0	27			185
I.100	Dig output 1 cfg	Digital output 1 configuration	[0] Drive Ready [1] Alarm state [2] Not in alarm [3] Motor run [4] Motor stop [5] REV rotation [6] Steady state [7] Ramping [8] UV running [9] Out trq>thr [10] Current lim [11] DC-link lim [12] Limit active [13] Autocapt run [14] BU overload [15] Neg pwrfact [16] PID err >< [17] PID err>thr [18] PID err<thr [19] PIDerr><(inh) [20] PIDerr>(inh) [21] PIDerr<(inh) [22] FWD enc rot [23] REV enc rot [24] Encoder stop		51	0	78			112

Code	PARAMETER		PICK LIST		Def.	Min	Max	Unit	Variat.	IPA
	Name	DESCRIPTION	Selection	Description						
I.202	An in 1 gain	Analog Input 1 gain			1	-9.99	9.99	%	0.01	120
I.203	An in 1 minimum	An Input 1 minimum value			0	0	99.99	%	0.1	121
I.204	An in 1 filter	Time constant of digital filter on Analog input 1			0.1	0.001	0.25	sec	0.001	122
I.205	An in 1 DeadBand	Analog Input 1 dead band			0	0	99.9	%	0.01	182
I.210	Reserved									
I.211	Reserved									
I.212	Reserved									
I.213	Reserved									
I.214	Reserved									
I.215	Reserved									
I.220	Reserved									
I.221	Reserved									
I.222	Reserved									
I.223	Reserved									
I.224	Reserved									
I.225	Reserved									
I.300	Analog out 1 cfg	Analog Output 1 configuration	[0] Freq out abs [1] Freq out [2] Output curr [3] Out voltage [4] Out trq (pos) [5] Out trq (abs) [6] Out trq [7] Out pwr (pos) [8] Out pwr (abs) [9] Out pwr [10] Out PF [11] Enc freq abs [12] Encoder freq [13] Freq ref abs [14] Freq ref [15] Load current [16] Magn current [17] PID output [18] DClink volt [19] U current [20] V current [21] W current [22] Freq ref fac	Output Frequency absolute value. Output Frequency. Output Current. Output Voltage. Output Torque positive value. Output Torque absolute value. Output Torque. Output Power positive value. Output Power absolute value. Output Power. Output Power Factor. Encoder frequency absolute value. Encoder frequency. Frequency reference absolute value. Frequency reference Load Current. Motor Magnetizing Current. PID regulator output. DC bus capacitors level. Output phase U current signal. Output phase V current signal. Output phase W current signal. Multiplier factor for frequency reference	0	0	22			133
I.301	An out 1 offset	Analog output 1 offset			0	-9.99	9.99		0.01	134
I.302	An out 1 gain	Analog output 1 gain			1	-9.99	9.99		0.01	135
I.303	An out 1 filter	Time constant of output filter			0	0	2.5	sec	0.01	136
I.310	Analog out 2 cfg	Analog Output 2 configuration	As for I.300		2	0	22			137

Code	PARAMETER		PICK LIST		Def.	Min	Max	Unit	Variat.	IPA
	Name	DESCRIPTION	Selection	Description						
I.311	An out 2 offset	Analog output 2 offset			0	-9.99	9.99		0.01	138
I.312	An out 2 gain	Analog output 2 gain			1	-9.99	9.99		0.01	139
I.313	An out 2 filter	Time constant of output filter			0	0	2.5	sec	0.01	140
I.350	Exp an out 1 cfg	Expansion Analog Output 1 configuration (on Exp. board)	As for I.300		3	0	22			141
I.351	Exp AnOut 1 offs	Expansion Analog Output 1 offset			0	-9.99	9.99		0.01	142
I.352	Exp AnOut 1 gain	Expansion Analog Output 1 gain			1	-9.99	9.99		0.01	143
I.353	Exp AnOut 1 filt	Time constant of output filter			0	0	2.5	sec	0.01	144
I.400	Inp by serial en	Virtual Digital enabling			0	0	255			145
I.410	Exp in by ser en	Expansion Virtual Digital Inputs enabling			0	0	15			146
I.420	Out by serial en	Virtual Digital Outputs setting enabling			0	0	15			147
I.430	Exp OutBySer en	Expansion Virtual Digital Outputs enabling			0	0	3			148
I.450	An out by ser en	Virtual Analog Outputs enabling			0	0	255			149
I.500	Encoder enable	Enabling of the encoder measure	[0] Disable [1] Enable	Encoder measure disabled. Encoder measure enabled.	0	0	1			150
I.501	Encoder ppr	Encoder nameplate pulses per revolution			1024	1	9999			151
I.502	Enc channels cfg	Encoder channels configuration	[0] One Channel [1] Two Channels	A (K1) encoder channel A and B (K1 and K2) encoder channels	1	0	1			152
I.503	Enc spd mul fact	Multiplier factor of the encoder pulses, set in the I.501			1	0.01	99.99			153
I.504	Enc update time	Encoder pulses sampling time	[0] 1ms [1] 4ms [2] 16ms [3] 0.25s [4] 1s [5] 5s		0	0	5			154
I.505	Enc power supply	Encoder power supply level	[0] 5.2V [1] 5.6V [2] 8.3V [3] 8.7V		0	0	3			181
I.506	Enc fault enable	Enable ENC alarm, Encoder cable break	[0] Disable [1] Enable	Encoder alarm disabled Encoder alarm enabled	0	0	1			197
I.600	Serial link cfg	Serial line configuration protocol & mode	[0] FoxLink 7E1 [1] FoxLink 701 [2] FoxLink 7N2 [3] FoxLink 8N1 [4] ModBus 8N1 [5] JBus 8N1	Type(DataBit) Parity (StopBit) FoxLink 7E1 (7) Even (1) FoxLink 701 (7) Odd (1) FoxLink 7N2 (7) None (2) FoxLink 7O1 (8) None (1) Modbus 8N1 (8) None (1) Jbus 8N1 (8) None (1)	4	0	5		0.1	155
I.601	Serial link bps	Serial line baudrate	[0] 600 baud [1] 1200 baud [2] 2400 baud [3] 4800 baud [4] 9600 baud [5] 19200 baud [6] 38400 baud	600 baud rate 1200 baud rate 2400 baud rate 4800 baud rate 9600 baud rate 19200 baud rate 38400 baud rate	4	0	6			156
I.602	Device address	Serial line address of the drive			1	0	99		1	157

Code	PARAMETER		PICK LIST		Def.	Min	Max	Unit	Variat.	IPA
	Name	DESCRIPTION	Selection	Description						
I.603	Ser answer delay	Serial line answer delay time			1	0	250	msec	1	158
I.604	Serial timeout	Serial line transmission timeout			0	0	25	sec	0.1	159
I.605	En timeout alm	Setting time out alarm	[0] Disable [1] Enable	Drive NOT in alarm and signal on a digital output Drive IN alarm and signal on a digital output	0	0	1			160
I.700	Reserved	Expansion optional 1 card type								
I.701	Reserved									
I.750	Reserved									
I.751	Reserved									
I.752	Reserved									
I.753	Reserved									
I.754	Reserved									
I.760	Reserved									
I.761	Reserved									
I.762	Reserved									
I.763	Reserved									
I.764	Reserved									
I.765	Reserved									
I.770	Reserved									
I.771	Reserved									
I.772	Reserved									
I.773	Reserved									
I.774	Reserved									
I.775	Reserved									
FREQ & RAMP										
F.000	Motorpot ref	Motorpot reference (it can be set using up and down commands)			0	0	F.020	Hz	0.01	300
F.010	Mp Acc/Dec time	Motorpot Accel. and Decel. ramp time			10	0.1	999.9	sec	0.1	301
F.011	Motorpot offset	Motopotentiometer minimum reference			0	0	F.020	Hz	0.1	302
F.012	Mp output mode	Unipolar / bipolar Motorpotentiometer	[0] Unipolar [1] Bipolar		0	0	1			303
F.013	Mp auto save	Motopotenziometer auto save function	[0] Disable [1] Enable		1	0	1			304
F.014	MpRef at stop	Behavior of the frequency reference from Motorpotentiometer during a Stop sequence	[0] Last value [1] Follow ramp	Mot. reference will retain its current value Mot. reference will ramp down to zero, following the deceleration ramp in use	0	0	1			351
F.020	Max ref freq	Motor maximum frequency value (for both directions)			50	25	250	Hz	0.1	305
F.021	Min ref freq	Minimum frequency value			0	0	F.020	Hz	0.1	306
F.050	Ref 1 channel	Source of the Reference 1	[0] Null [1] Analog inp 1 [2] Analog inp 2 [3] Freq ref x [4] Multispeed [5] Motorpotent [6] Analog inp 3 [7] Encoder [8] Reserved	Null Analog input 1 Analog input 2 Frequency reference F.100 (S.203) Multi frequencies Motorpotientometer reference Analog input 3 Encoder signal	4	4	4			307
F.051	Ref 2 channel	Source of the Reference 2	[0] Null	Null	0	0	8			308

Code	PARAMETER		PICK LIST		Def.	Min	Max	Unit	Variat.	IPA
	Name	DESCRIPTION	Selection	Description						
			[1] Analog inp 1 [2] Analog inp 2 [3] Freq ref x [4] Multispeed [5] Motorpotent [6] Analog inp 3 [7] Encoder [8] Reserved	Analog input 1 Analog input 2 Frequency reference F.101 Multispeed Motorpotentometer reference Analog input 3 Encoder signal						
F.060	MltFrq channel 1	Source of the Multispeed 1		As for F.050, Reference 1 source	3	0	8			309
F.061	MltFrq channel 2	Source of the Multispeed 2		As for F.051, Reference 2 source	3	0	8			310
F.080	FreqRef fac src	Frequency reference multiplier factor source	[0] Null [1] Analog inp 1 [2] Analog inp 2 [3] Analog inp 3	Null Analog input 1 Analog input 2 Analog input 2	0	0	3			342
F.100	Frequency ref 0	Digital Reference frequency 0			10	-F.020	F.020	Hz	0.1	311
F.101	Frequency ref 1	Digital Reference frequency 1			50	-F.020	F.020	Hz	0.1	312
F.102	Frequency ref 2	Digital Reference frequency 2			0	-F.020	F.020	Hz	0.1	313
F.103	Frequency ref 3	Digital Reference frequency 3			0	-F.020	F.020	Hz	0.1	314
F.104	Frequency ref 4	Digital Reference frequency 4			0	-F.020	F.020	Hz	0.1	315
F.105	Frequency ref 5	Digital Reference frequency 5			0	-F.020	F.020	Hz	0.1	316
F.106	Frequency ref 6	Digital Reference frequency 6			0	-F.020	F.020	Hz	0.1	317
F.107	Frequency ref 7	Digital Reference frequency 7			0	-F.020	F.020	Hz	0.1	318
F.108	Frequency ref 8	Digital Reference frequency 8			0	-F.020	F.020	Hz	0.1	319
F.109	Frequency ref 9	Digital Reference frequency 9			0	-F.020	F.020	Hz	0.1	320
F.110	Frequency ref 10	Digital Reference frequency 10			0	-F.020	F.020	Hz	0.1	321
F.111	Frequency ref 11	Digital Reference frequency 11			0	-F.020	F.020	Hz	0.1	322
F.112	Frequency ref 12	Digital Reference frequency 12			0	-F.020	F.020	Hz	0.1	323
F.113	Frequency ref 13	Digital Reference frequency 13			0	-F.020	F.020	Hz	0.1	324
F.114	Frequency ref 14	Digital Reference frequency 14			0	-F.020	F.020	Hz	0.1	325
F.115	BakPwr max freq	Digital refer frequency 15. When in backup power mode, it defines the upper limit of the inverter output frequency			5	-F.020	F.020	Hz	0.1	326
F.116	Smooth start frq	Frequency reference during smooth start			2	-F.020	F.020	Hz	0.1	327
F.201	Acceleration 1	Linear acceleration with ramp set 1			0.6	0.01	5.0	m/s ²	0.01	329
F.202	Deceleration 1	Linear deceleration with ramp set 1			0.6	0.01	5.0	m/s ²	0.01	330
F.203	Acceleration 2	Linear acceleration with ramp set 2			0.6	0.01	5.0	m/s ²	0.01	331
F.204	Deceleration 2	Linear deceleration with ramp set 2			0.6	0.01	5.0	m/s ²	0.01	332
F.205	Acceleration 3	Linear acceleration with ramp set 3			0.6	0.01	5.0	m/s ²	0.01	333
F.206	Deceleration 3	Linear deceleration with ramp set 3			0.6	0.01	5.0	m/s ²	0.01	334
F.207	Acceleration 4	Linear acceleration with ramp set 4			0.6	0.01	5.0	m/s ²	0.01	335
F.208	Deceleration 4	Linear deceleration with ramp set 4			0.6	0.01	5.0	m/s ²	0.01	336
F.250	Ramp S-shape	S-shaped ramp enable	[0] Disable [1] Enable	Linear ramps S-shaped ramps	1	0	1			337
F.251	Jerk acc ini 1	Jerk applied at the beginning of an acceleration with ramp sets 1 and 3			1.00	0.01	10.00	m/s ³	0.01	343
F.252	Jerk acc end 1	Jerk applied at the end of an acceleration with ramp sets 1 and 3			1.40	0.01	10.00	m/s ³	0.01	344
F.253	Jerk dec ini 1	Jerk applied at the beginning of a deceleration with ramp sets 1 and 3			1.40	0.01	10.00	m/s ³	0.01	345
F.254	Jerk dec end 1	Jerk applied at the end of a deceleration with ramp sets 1 and 3			1.00	0.01	10.00	m/s ³	0.01	346

Code	PARAMETER		PICK LIST		Def.	Min	Max	Unit	Variat.	IPA
	Name	DESCRIPTION	Selection	Description						
F.255	Jerk acc ini 2	Jerk applied at the beginning of an acceleration with ramp sets 2 and 4			1.00	0.01	10.00	m/s3	0.01	347
F.256	Jerk acc end 2	Jerk applied at the end of an acceleration with ramp sets 2 and 4			1.40	0.01	10.00	m/s3	0.01	348
F.257	Jerk dec ini 2	Jerk applied at the beginning of a deceleration with ramp sets 2 and 4			1.40	0.01	10.00	m/s3	0.01	349
F.258	Jerk dec end 2	Jerk applied at the end of a deceleration with ramp sets 2 and 4			1.00	0.01	10.00	m/s3	0.01	350
F.260	Ramp extens src	Source for the Ramp time extension function	[0] Null [1] Analog inp 1 [2] Analog inp 2 [3] Analog inp 3	Null Analog input 1 Analog input 2 Analog input 3	0	0	3			338
F.270	Jump amplitude	Jump frequencies hysteresis			0	0	100	Hz	0.1	339
F.271	Jump frequency 1	Jump frequency 1			0	0	250	Hz	0.1	340
F.272	Jump frequency 2	Jump frequency 2			0	0	250	Hz	0.1	341
PARAMETER										
P.000	Cmd source sel	It defines the use of START and STOP commands	[0] CtrlWordOnly [1] CtlWrd & kpd		0	0	1			400
P.002	Reversal enable	Reversal enabling	[0] Disable [1] Enable	Disabling reverse rotation Enabling reverse rotation	1	0	1			402
P.003	Safety	Safe start definition	[0] OFF [1] ON	START allowed with RUN terminal connected at the power on START not allowed with RUN terminal connected at the power on	1	0	1			403
P.010	Control mode	Drive control mode	[0] V/f open loop [1] V/f clsd loop	V/f control w/o encoder feedback V/f control with encoder feedback	0	0	1			498
P.020	Mains voltage	Rated value of the line voltage	230 380 400 420 440 460 480		400	230	480	V		404
P.021	Mains frequency	Rated value of the line voltage frequency	50 60		50	50	60	Hz		405
P.040	Motor rated curr	Rated current of the motor			(*)	(*)	(*)	A	0.1	406
P.041	Motor pole pairs	Pole Pairs of the motor			2	1	60			407
P.042	Motor power fact	Motor power factor			(*)	0.01	1		0.01	408
P.043	Motor stator R	Measurement of the stator resistance of the motor			(*)	0	99.99	ohm	0.01	409
P.044	Motor cooling	Motor type cooling	[0] Natural [1] Forced	Self ventilated Assisted ventilation	0	0	1			410
P.045	Motor thermal K	Motor thermal constant			30	1	120	min		411
P.060	V/f shape	V/F Curve Type	[0] Custom [1] Linear [2] Quadratic	V/F curve defined by the user Linear characteristic Quadratic characteristic	1	0	2			412
P.061	Base voltage	Motor base (rated) voltage			380	50	528	V	1	413
P.062	Base frequency	Base frequency			50	25	500	Hz	0.1	414
P.063	V/f interm volt	V/F intermediate voltage			190	0	P.061	V	1	415

Code	PARAMETER		PICK LIST		Def.	Min	Max	Unit	Variat.	IPA
	Name	DESCRIPTION	Selection	Description						
P.064	V/f intern freq	V/F intermediate frequency			25	1.0	P.062	Hz	0.1	416
P.080	Max output freq	Maximum output frequency			110	0	110	% of F.020	1	417
P.081	Min output freq	Minimum output frequency			0.0	0.0	25.0	% of F.020	0.1	418
P.100	Slip compensat	Amount of slip compensation during motoring			50	0	250	%	1	419
P.101	Slip comp filter	Time constant of slip compensation			0.3	0	10	sec	0.1	420
P.102	Slip comp regen	Amount of slip compensation during regeneration			50	0	250	%	1	500
P.120	Manual boost [%]	Torque boost level			3	0	25	% of P.061	1	421
P.121	Boost factor src	Boost level source	[0] Null [1] Analog inp 1 [2] Analog inp 2 [3] Analog inp 3	Null Analog input 1 Analog input 2 Analog input 3	0	0	3			422
P.122	Auto boost en	Automatic boost function enabling	[0] Disable [1] Enable	Automatic boost function disabled Automatic boost function enabled	0	0	1			423
P.140	Magn curr gain	Magnetizing current regulator gain			0	0	100	%	0.1	424
P.160	Osc damping gain	Damping gain			10	0	100		1	425
P.170	Spd ctrl P-gainL	Speed loop proportional gain (low speed)			2.0	0.0	100.0	%	0.1	501
P.171	Spd ctrl I-gainL	Speed loop integral gain (low speed)			1.0	0.0	100.0	%	0.1	502
P.172	Spd ctrl P-gainH	Speed loop proportional gain (high speed)			2.0	0.0	100.0	%	0.1	503
P.173	Spd ctrl I-gainH	Speed loop integral gain (high speed)			1.0	0.0	100.0	%	0.1	504
P.174	Spd gain thr L	Speed loop gain scheduling low threshold			0.0	0.0	F.020	Hz	0.1	507
P.175	Spd gain thr H	Speed loop gain scheduling high threshold			0.0	0.0	F.020	Hz	0.1	508
P.176	Spd PI High lim	Speed regulator High limit			10.0	0.0	100.0	% of F.020	0.1	509
P.177	Spd PI Low lim	Speed regulator Low limit			-10.0	-100.0	0.0	% of F.020	0.1	510
P.178	SpdPI lim FacSrc	Speed regulator limits factor source	[0] Null [1] Analog inp 1 [2] Analog inp 2 [3] Analog inp 3	Null Analog input 1 Analog input 2 Analog input 3	0	0	3			511
P.180	SW clamp enable	Current clamp enable	[0] Disable [1] Enable		1	0	1			426
P.181	Clamp alm HldOff	Hold off time for current clamp alarm. Set to maximum (25.5s) to disable the alarm			3.0	0	25.5	s	0.1	512
P.200	Ramp CurLim mode	Enable current limitation during ramp	[0] None [1] PI Limitor [2] Ramp freeze		0	0	2			427
P.201	Accel curr limit	Current limit in acceleration phase			(*)	20	(*)	% of I nom		428
P.202	En lim in steady	Enable current limitation in steady state	[0] Disable [1] Enable		0	0	1			429
P.203	Curr lim steady	Current limit at constant speed			(*)	20	(*)	% of I nom	1	430
P.204	Curr ctrl P-gain	Current limiter proportional gain			10.0	0.1	100.0	%		431
P.205	Curr ctrl I-gain	Current limiter integral gain			30.0	0.0	100.0	%	0.1	432
P.206	Curr ctr feedfwd	Current limiter feed-forward			0	0	250	%	1	433
P.207	Decel curr limit	Current limit in deceleration phase			(*)	20	(*)	% of I nom	1	494
P.220	En DC link ctrl	Stall prevention during dec. for overvoltage	[0] None	None	0	0	2			434

Code	PARAMETER		PICK LIST		Def.	Min	Max	Unit	Variat.	IPA
	Name	DESCRIPTION	Selection	Description						
			[1] PI Limitor [2] Ramp freeze	PI Limit regulator On/Off Ramp						
P.221	DC-lnk ctr Pgain	DC link voltage limiter proportional gain			3.0	0.1	100.0	%	0.1	435
P.222	DC-lnk ctr Igain	DC link voltage limiter integral gain			10.0	0.0	100.0	%	0.1	436
P.223	DC-link ctr FF	DC link voltage limiter feed-forward			0	0	250	%	1	437
P.240	OverTorque mode	Overtorque mode	[0] No Alm,Chk on [1] No Alm,Chk ss [2] Alm always [3] Alm steady st	0: Overtorque detection always active and Over-torque alarm disabled. 1: Overtorque detection in steady state and Over-torque alarm disabled. 2: Overtorque detection always active and Over-torque alarm enabled. 3: Overtorque detection in steady state and Over-torque alarm enabled.	0	0	3			438
P.241	OT curr lim thr	Current limit for overtorque			110	20	200	%	1	439
P.242	OT level fac src	Overtorque level factor source	[0] Null [1] Analog inp 1 [2] Analog inp 2 [3] Analog inp 3	Null Analog input 1 Analog input 2 Analog input 3	0	0	3			440
P.243	OT signal delay	Delay time for overtorque signaling			0.1	0.1	25	sec	0.1	441
P.260	Motor OL prot en	Enabling of motor overload protection	[0] Disable [1] Enable		1	0	1			444
P.280	BU configuration	Braking unit configuration	[0] BU disabled [1] BU en OL dis [2] BU en OL en	BU disabled BU enabled & Overload disable BU & Overload enabled	1	0	2			445
P.281	Brake res value	Ohmic value of braking resistor			(*)	1	250	ohm	1	446
P.282	Brake res power	Braking resistor power			(*)	0.01	25	kW	0.01	447
P.283	Br res thermal K	Braking resistor thermal constant			(*)	1	250	sec	1	448
P.300	DC braking level	DC braking level			75	0	100	% of I nom	1	449
P.301	DCB lev fac src	DC braking level factor source	[0] Null [1] Analog inp 1 [2] Analog inp 2 [3] Analog inp 3	Null Analog input 1 Analog input 2 Analog input 3	0	0	3			450
P.321	Autocapture Ilim	Catch on flight current limit			120	20	(*)	% of I nom	1	456
P.322	Demagnetiz time	Demagnetization minimum time			(*)	0.01	10	sec	0.01	457
P.323	Autocap f scan t	Frequency scanning time during Pick Up			1	0.1	25	sec	0.1	458
P.324	Autocap V scan t	Voltage scanning time during Pick Up			0.2	0.1	25	V	0.1	459
P.340	Undervoltage thr	Undervoltage threshold			0	0	80	% of P.020	1	462
P.341	Max pwrloss time	Restart time from undervoltage			0	0	25	sec	0.1	463
P.342	UV alarm storage	Enabling of undervoltage alarm storage	[0] Disable [1] Enable		1	0	1			464
P.343	UV Trip Mode	Undervoltage tripping mode	[0] Disabled [1] CoastThrough [2] Emg stop	Function disabled Kinetic energy recovering Emergency stop mode	0	0	2			491
P.344	BU threshold factor	BU Threshold setting			100	90	100	%	1	514
P.360	OV prevention	Automatic PickUp enabling after Over-voltage	[0] Disable [1] Enable		0	0	1			465
P.380	Autoreset attmps	Number of autoreset attempts			0	0	255			466

Code	PARAMETER		PICK LIST		Def.	Min	Max	Unit	Variat.	IPA
	Name	DESCRIPTION	Selection	Description						
P.381	Autoreset clear	En. automatic reset of autorestart attempts			10	0	250	min	1	467
P.382	Autoreset delay	Autoreset time delay			5	0.1	50	sec	0.1	468
P.383	Autoreset flt rly	Alarm relay contacts behaviour during autoreset	[0] OFF [1] ON		1	0	1			469
P.400	Ext fault mode	External fault detection mode	[0] Alm alw, No AR [1] Alm run, No AR [2] Alm alw, ARes [3] Alm run, ARes	- Drive in alarm. Alarm always active. Alarm autoreset is not possible. - Drive in alarm. Alarm active only with running motor. Alarm autoreset is not possible. - Drive in alarm. Alarm always active. Alarm autoreset is possible. - Drive in alarm. Alarm active only with running motor. Alarm autoreset is possible.	0	0	3			470
P.410	Ph Loss detect en	Phase Loss detection enabling	[0] Disable [1] Enable		1	0	1			492
P.420	Volt reduc mode	Voltage reduction mode	[0] Always [1] Steady state	Always Constant speed only	0	0	1			471
P.421	V reduction fact				100	10	100	% of P.061	1	472
P.422	V fact mult src	Source of voltage reduction factor multiplier	[0] Null [1] Analog inp 1 [2] Reserved [3] Reserved	Null Analog input 1	0	0	3			473
P.440	Frequency thr 1	Frequency 1 level detection			0.5	0	F.020	Hz	0.1	474
P.441	Freq prog 1 hyst	Hysteresis amplitude related to P-420			0.2	0	F.020	Hz	0.1	475
P.442	Frequency thr 2	Frequency 2 level detection			0	0	F.020	Hz	0.1	476
P.443	Freq prog 2 hyst	Hysteresis amplitude related to P-422			0.5	0	F.020	Hz	0.1	477
P.460	Const speed tol	Tolerance at constant speed			0	0	25	Hz	0.1	478
P.461	Const speed dly	Ramp end signalling delay			0.1	0	25	sec	0.1	479
P.480	Heatsnk temp lev	Heatsink temperature signalling level			70	10	110	°C	1	480
P.481	Heatsnk temp hys	Hysteresis band related to P.480			5	0	10	°C	1	481
P.482	UHS Detect Mode	Enable UHS alarm	[0] Disable [1] Enable		0	0	1			513
P.500	Switching freq	Modulation frequency	[0] 1kHz [1] 2kHz [2] 3kHz [3] 4kHz [4] 6kHz [5] 8kHz [6] 10kHz [7] 12kHz [8] 14kHz [9] 16kHz [10] 18kHz		(*)	0	(*)			482
P.501	Sw freq reduc en	Enabling of switching frequency reduction	[0] Disable [1] Enable		0	0	1			483
P.502	Min switch freq	Minimum switching frequency	As for P.500		(*)	0	P.500			495
P.520	Overmod max lev	Overmodulation level			0	0	100	%	1	484
P.540	Out Vlt auto adj	Automatic adjustment of output voltage			1	0	1			485
P.560	Deadtime cmp lev	Dead times compensation limit			(*)	0	255			486

Code	PARAMETER		PICK LIST		Def.	Min	Max	Unit	Variat.	IPA
	Name	DESCRIPTION	Selection	Description						
P.561	Deadtime cmp slp	Dead times compensation slope			(*)	0	255			487
P.580	Startup display	IPA of the parameter to be displayed at power on			8	1	1999			488
P.600	Speed dsply fact	Speed conversion constant for display			10.00	0.01	99.99		0.01	489
P.998	Param access lev	Access level			2	1	3			499
P.999	Param prot code	Parameters protection code	0 Protection disabled 1 Protection enabled (*) = only with motor stopped 2 Protection enabled (*) = only with motor stopped 3 Protection disabled	Stopped motor: possibility to write all parameters. Running motor: some parameters are writing protected (IPA in bold) All parameters are writing protected excepted: - F000, F100..F116, multispeed function parameters - P999 Param prot code - C000 Save parameter (*) - C020 Alarm clear - H500..H511, serial line commands. All parameters are writing protected excepted: - P999 Param prot code - C000 Save parameter (*) - C020 Alarm clear - H500..H511, serial line commands. Stopped motor: possibility to write all parameters. Running motor: some parameters are writing protected (IPA in bold) Possibility to execute Save parameter also with running motor.	0	0	3			490
APPLICATION										
A.000	PID mode	PID mode	[0] Disable [1] Freq sum [2] Freq direct [3] Volt sum [4] Volt direct [5] Stand alone [6] St-Al always	Null PID out in sum with ramp out ref (Feed forward) PID out not in sum with ramp out ref (no Feed forward) PID out in sum with voltage ref from V/f curve (Feed forward) PID out not in sum with voltage ref from V/f curve (no Feed forward) PID function as generic control (only with drive in RUN) PID function as generic control (any drive status)	0	0	6			1200
A.001	PID ref sel	PID reference selector	[0] Null [1] Analog inp 1 [2] Analog inp 2 [3] Analog inp 3 [4] Frequency ref [5] Ramp output [6] Digital ref [7] Encoder freq	Null Analog input 1 Analog input 2 Analog input 3 Frequency reference Ramp output Internal reference Encoder frequency	0	0	7			1201
A.002	PID fbk sel	PID feedback selector	[0] Null	Null	0	0	7			1202

Code	PARAMETER		PICK LIST		Def.	Min	Max	Unit	Variat.	IPA
	Name	DESCRIPTION	Selection	Description						
			[1] Analog inp 1 [2] Analog inp 2 [3] Analog inp 3 [4] Encoder freq [5] Output curr [6] Output torque [7] Output power	Analog input 1 Analog input 2 Analog input 3 Encoder frequency Output peak current Output torque Output power						
A.003	PID digital ref	PID digital reference			0	-100	100	%	0.1	1203
A.004	PID activat mode	PID active in steady state only	[0] Always [1] Steady state		0	0	1			1204
A.005	PID-Encoder sync	Enabling of encoder / PID synchronism	[0] Disable [1] Enable		0	0	1			1205
A.006	PID err sign rev	Error sign reversal	[0] Disable [1] Enable		0	0	1			1206
A.007	PIDInteg init en	Integral term initialization at start	[0] Disable [1] Enable		0	0	1			1207
A.008	PID update time	PID updating time			0	0	2.5	sec	0.01	1208
A.050	PID Prop gain 1	Proportional term gain 1			0	0	99.99		0.01	1209
A.051	PID Int tconst 1	Integral action time 1			99.99	0	99.99		0.01	1210
A.052	PID Deriv gain 1	Derivative action time 1			0	0	99.99		0.01	1211
A.053	PID Prop gain 2	Proportional term gain 2			0	0	99.99		0.01	1212
A.054	PID Int tconst 2	Integral action time 2			99.99	0	99.99		0.01	1213
A.055	PID Deriv gain 2	Derivative action time 2			0	0	99.99		0.01	1214
A.056	PID high limit	PID output upper limit			100	-100	100	%	0.1	1215
A.057	PID low limit	PID output lower limit			-100	-100	100	%	0.1	1216
A.058	PID max pos err	PID max. positive error			5	0.1	100	%	0.1	1217
A.059	PID min neg err	PID max. negative error			5	0.1	100	%	0.1	1218
A.080	Cont close delay	RUN contactor close delay			0.20	0	10	s	0.01	1316
A.081	Magnet time	Motor magnetization time			1	0	10	s	0.01	1317
A.082	Brake open delay	Brake contactor open delay			0.20	0	10	s	0.01	1318
A.083	Smooth start dly	Smooth start duration			0	0	10	s	0.01	1319
A.084	DCBrake stp time	Duration of 0Hz braking at stop			1	0	10	s	0.01	1320
A.085	Brake close dly	Brake contactor close delay			0.20	0	10	s	0.01	1321
A.086	Cont open delay	RUN contactor open delay			0.20	0	10	s	0.01	1322
A.087	Current pres thr	Current threshold for inverter output phases check			10	0	100	%	1	1325
A.088	Sel match code	Code to be compared to the status of Freq selectors			0	0	15			1326
A.090	Car max speed	Speed of the lift car when the inverter output frequency is equal to P.062			0.50	0.01	5.00	m/s	0.01	1323
A.091	Ramp factor 1	multiplier for acc/dec and jerks of ramp sets 1 and 3			1.00	0.01	2.50		0.01	1324
A.092	Ramp factor 2	multiplier for acc/dec and jerks of ramp sets 2 and 4			1.00	0.01	2.50		0.01	1327
A.220	Lift stop mode	Lift behavior at stop	[0] Dcb at stop [1] Normal stop	DC brake is performed after the output frequency is below P.440 threshold DC brake is not performed at stop	1	0	1			1350
A.221	Lift start seq (fw 03-07)	Select working mode of Lift start sequence	[0] Normal	You can activate the start sequence with the Run Fwd command or Run Rev command	0	0	1			1351

Code	PARAMETER		PICK LIST		Def.	Min	Max	Unit	Variat.	IPA
	Name	DESCRIPTION	Selection	Description						
			[1] Mltspeed !=0	You can activate the start sequence with multispeed selection. The Multispeed value different from zero causes the start of sequence. The Run Fwd command or Run Rev command must be present.						
A.300	AND1 In 1 src	Source of In 1 of logic block AND1	see list of l.000		0	0	27			1355
A.301	AND1 In 2 src	Source of In 2 of logic block AND1	see list of l.000		0	0	27			1356
A.302	AND2 In 1 src	Source of In 1 of logic block AND2	see list of l.000		0	0	27			1357
A.303	AND2 In 2 src	Source of In 2 of logic block AND2	see list of l.000		0	0	27			1358
A.304	AND3 In 1 src	Source of In 1 of logic block AND3	see list of l.000		0	0	27			1359
A.305	AND3 In 2 src	Source of In 2 of logic block AND3	see list of l.000		0	0	27			1360
A.306	OR1 In 1 src	Source of In 1 of logic block OR1	see list of l.000		0	0	27			1361
A.307	OR1 In 2 src	Source of In 2 of logic block OR1	see list of l.000		0	0	27			1362
A.308	OR2 In 1 src	Source of In 1 of logic block OR2	see list of l.000		0	0	27			1363
A.309	OR2 In 2 src	Source of In 2 of logic block OR2	see list of l.000		0	0	27			1364
A.310	OR3 In 1 src	Source of In 1 of logic block OR3	see list of l.000		0	0	27			1365
A.311	OR3 In 2 src	Source of In 2 of logic block OR3	see list of l.000		0	0	27			1366
A.312	NOT1 In src	Source of Input of logic block NOT1	see list of l.000		0	0	27			1367
A.313	NOT2 In src	Source of Input of logic block NOT2	see list of l.000		0	0	27			1368
A.314	NOT3 In src	Source of Input of logic block NOT3	see list of l.000		0	0	27			1369
A.315	NOT4 In src	Source of Input of logic block NOT4	see list of l.000		0	0	27			1370
A.320	Timer 1 mode	Select working mode of Timer 1	[0] Disable [1] On delay [2] Off delay [3] On/Off delay [4] Pulse [5] Sym flasher		0	0	5			1375
A.321	Timer 1 set src	Select input signal of Timer 1	See list of l.000		0	0	27			1376
A.322	Timer 1 delay	Set delay of Timer 1	See list of l.000		3.00	0.00	30.00	sec	0.01	1377
COMMAND										
C.000	Save parameters	Save parameters command	off do	No action. Save parameters command.	off	off	do			800
C.001	Recall param	Recall last set of saved parameters	off do	No action. Recall last set of saved parameters.	off	off	do			801
C.002	Load default	Recall of the factory parameters.	off do	No action. Load default parameters.	off	off	do			802
C.020	Alarm clear	Reset of the the Alarm List register	off do	No action. Clear alarm register command.	off	off	do			803
C.040	Reserved									
C.041	Reserved									
C.050	Rst MdplcPrecRun	Reset mdplc error at previous run	off do	No action. Reset mdplc error	off	off	do			809
C.060	Calculate space	Off line space evaluation	off do	No action. Start	off	off	do			809
C.070	Reserved									
C.071	Reserved									
C.100	Measure stator R	Motor Autotune command	off do	No action. Autotune command.	off	off	do			806

Code	PARAMETER		PICK LIST		Def.	Min	Max	Unit	Variat.	IPA
	Name	DESCRIPTION	Selection	Description						
HIDDEN										
This menu is not available on the keypad. The setting and the reading of the parameters here contained, can be performed exclusively via serial line or through SBI card.										
H.000		Virtual digital command			0	0	255			1000
H.001		Exp virtual digital command			0	0	255			1001
H.010		Virtual digital state			0	0	255			1002
H.011		Exp Virtual digital state			0	0	255			1003
H.020		Virtual An Output 1			0	-32768	32767			1004
H.021		Virtual An Output 2			0	-32768	32767			1005
H.022		Exp Virtual An Output 1			0	-32768	32767			1006
H.030										
H.031										
H.032										
H.033										
H.034		Drive status			0	0	65535			1042
H.040		Progress			0	0	100			1009
H.050		Drive output frequency at 32bit (LSW) (d.000)			0	-2 ³¹	2 ³¹⁻¹			1010
H.051		Drive output frequency at 32bit (MSW) (d.000)			0	-2 ³¹	2 ³¹⁻¹			1011
H.052		Drive reference frequency at 32bit (LSW) (d.001)			0	-2 ³¹	2 ³¹⁻¹			1012
H.053		Drive reference frequency at 32bit (MSW) (d.001)			0	-2 ³¹	2 ³¹⁻¹			1013
H.054		Output speed (d.000)*(P.600) at 32bit (LSW) (d.007)			0	-2 ³¹	2 ³¹⁻¹			1014
H.055		Output speed (d.000)*(P.600) at 32bit (MSW) (d.007)			0	-2 ³¹	2 ³¹⁻¹			1015
H.056		Speed Ref (d.001)*(P.600) at 32bit (LSW) (d.008)			0	-2 ³¹	2 ³¹⁻¹			1016
H.057		Speed Ref (d.001)*(P.600) at 32bit (MSW) (d.008)			0	-2 ³¹	2 ³¹⁻¹			1017
H.058		Encoder freq at 32bit (LSW) (d.301)			0	-2 ³¹	2 ³¹⁻¹			1018
H.059		Encoder freq at 32bit (MSW) (d.301)			0	-2 ³¹	2 ³¹⁻¹			1019
H.060		Encoder speed (d.000)*(P.600) at 32bit (LSW) (d.302)			0	-2 ³¹	2 ³¹⁻¹			1044
H.061		Encoder speed (d.000)*(P.600) at 32bit (MSW) (d.302)			0	-2 ³¹	2 ³¹⁻¹			1045
H.062		Bitwise reading of active alarms (bit 0 to 15). Each bit is associated to a specific alarm, according to table 9.3.1.			0	0	2 ³¹⁻¹			1060
H.063		Bitwise reading of active alarms (bit 16 to 31). Each bit is associated to a specific alarm, according to table 9.3.1.			0	0	2 ³¹⁻¹			1061
H.100		Remote Digital Inputs (0..15)			0	0	65535			1021
H.101		Remote Digital Inputs (16..31)			0	0	65535			1022
H.110		Remote Digital Outputs (0..15)			0	0	65535			1023
H.111		Remote Digital Outputs (16..31)			0	0	65535			1024
H.120		Remote Analog input 1			0	-32768	32767			1025
H.121		Remote Analog input 2			0	-32768	32767			1026
H.130		Remote Analog output 1			0	-32768	32767			1027
H.131		Remote Analog output 2			0	-32768	32767			1028
H.500		Hardware reset			0	0	1			1029
H.501		Alarm reset			0	0	1			1030
H.502		Coast to stop			0	0	1			1031
H.503		Stop with ramp			0	0	1			1032

Code	PARAMETER		PICK LIST		Def.	Min	Max	Unit	Variat.	IPA
	Name	DESCRIPTION	Selection	Description						
H.504		Clockwise Start			0	0	1			1033
H.505		Anti-clockwise Start			0	0	1			1034
H.506		Clockwise Jog			0	0	1			1035
H.507		Anti-clockwise Jog			0	0	1			1036
H.508		Clockwise Flying restart			0	0	1			1037
H.509		Anti-clockwise Flying restart			0	0	1			1038
H.510		DC Brake			0	0	1			1039

Instruction manual

Series: AGL50

Revision: 0.4

Date: 15-12-2022

Code: 1S9AGLEN

WEG Automation Europe S.r.l.

Via Giosuè Carducci, 24

21040 Gerenzano (VA) · Italy