

WG20 GEARED MOTORS

**Gearboxes and
Geared Motors**
up to 159,000 lb-in

Industrial Motors

Commercial &
Appliance Motors

Automation

Digital &
Systems

Energy

Transmission &
Distribution

Coatings



Driving efficiency and sustainability





WG20

A NEW GENERATION of Geared Motors

As one of the leading global manufacturers and solutions providers of drive technology, WEG's aim was to expand its extensive range of products with the addition of gearboxes produced in its own facility. Perfect coordination of products throughout the drive train has put WEG in a position to offer customers an even greater and more complete range of solutions.

The Group's own center of excellence for geared motors in Austria, which has been part of the WEG Group since 2011 and has more than 50 years of experience in the development, production and sales of gearboxes and geared motors, took on the challenge of developing a program that meets both the current requirements of the market and WEG's high quality standards.

In order to meet the demands of state-of-the-art geared motors, the following market requirements had to be taken into account during the development phase:

STANDARD MOUNTING DIMENSIONS

For users, the aim was to make the new range of geared motors as easy and effortless to use as possible. To ensure installation in an existing system or production line worked effortlessly without incurring unnecessary costs for conversions, the developers decided to adapt the mounting dimensions of the new geared motors to products already established on the market. The objective: worldwide, easy and cost-effective interchangeability.

TORQUE TRANSMISSION

The geared motors needed to be compact, efficient, robust and reliable. In order to achieve this goal a transmission had to be designed which allows large ratio ranges in a two-stage model while being able to integrate easily into the newly designed gear housing.

EFFICIENCY

Energy efficiency has always been of paramount importance to WEG. The aim here was to live up to this demand when designing the new WG20 geared motors. This requires the perfect interaction of sophisticated technology and exclusive use of high quality components.

WORLDWIDE USE

To meet the requirements of global mechanical and plant engineering, it was vital that the new geared motors are capable of being used worldwide, while maintaining a high level of flexibility for applications.

The aim was to combine these and other market-related considerations and incorporate them into the designs of the geared motors, which are the perfect addition to WEG's range of products.

The solution is **WG20**.



Features



Highly efficient



In line with market



Optimized design



Less noise

YOUR REQUIREMENTS - OUR EXPERTISE

WG20 is the first geared motor range to be completely developed in-house at WEG. It comprises helical, parallel shaft, helical bevel and helical worm geared motors with torques between 440 and 159,000 lb-in. Already the two-stage units excel with their large ratio range, as well as being exceptionally efficient thanks to the sophisticated design. The light aluminum housings of the geared motors up to 5310 lb-in and the robust cast iron housings from 7260 lb-in provide a highly versatile and reliable product, with a wide range of possible applications.



HIGHLY EFFICIENT

The geared motors are available in a two-stage design featuring a large ratio range, which in turn makes them highly efficient. Furthermore, the products of the WG20 series demonstrate extremely low power losses. On the one hand, this is achieved by low circumferential speeds in the input stage and, on the other hand, by reducing splashing losses due to optimized amounts of lubricant. These characteristics also have a positive effect on the gear lifetime. Under normal conditions of use, the geared motors up to 5310 lb-in are maintenance-free and lubricated for life.



IN LINE WITH MARKET REQUIREMENTS

For maximum user convenience, the housing of the new gearbox series has been designed in keeping with market requirements. The crucial mounting dimensions of the design correspond with the specifications already established on the market which allows for direct exchange. This means that WG20 geared motors are not only suitable for use in new applications, but can also be easily integrated into existing systems as a replacement or for optimization purposes.

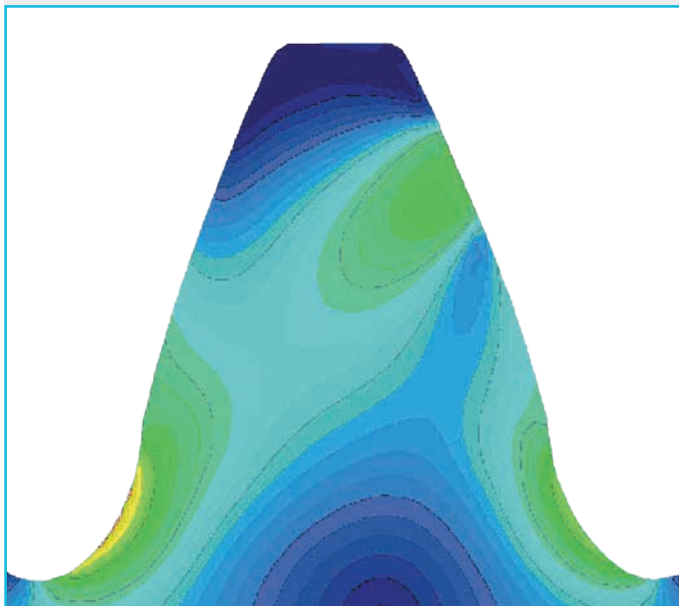

LESS NOISE

The WG20 series gearboxes are characterized by their smooth, quiet operation. High quality components, which originate almost exclusively from in-house production, engage perfectly to provide the basis for guaranteed low noise operation. Even the flexible gear wheel construction helps reduce noise emission. The small motor pinion allows for lower circumferential speeds in the first stage and reduced noise emissions.



OPTIMIZED DESIGN

When designing the new gearbox range, the designers paid particular attention to develop a robust housing, opting for a light aluminum construction for the frame sizes up to 5310 lb-in. The die casting process used in production not only benefits from a smooth surface for demanding hygienic applications, but also features excellent heat conductivity. The housing design additionally enhances this property. The intelligently designed surface encourages heat dissipation from the internal gear parts, thereby aiding more efficient operation and a longer life.

The housings for frame sizes from 7260 lb-in and larger are fabricated in MONOBLOC design and made of cast iron, making them especially sturdy and torsionally stiff.

Gear teeth geometry has also been refined. Calculations applying the finite element method have optimized gear teeth safety, especially in the tooth base area. High quality standards in the gear wheel production process not only ensure a sound and smooth operation, but also increased durability.

The overall compact design also affects the amount of lubricant used, helping to conserve resources when handling raw materials. Due to the arrangement of gearing and optimized housing interior, only low levels of oil are necessary in the gearbox.

WEG has also achieved improvements on the input side. The end shields and terminal box of motors up to frame size 132 are now made of light aluminum which considerably reduces the weight of the geared motor. For frame sizes 160 through 250 cast iron motors are used which are based on the latest W22 motor technology.

Furthermore, the terminal box dimensions have been increased for ease of access.

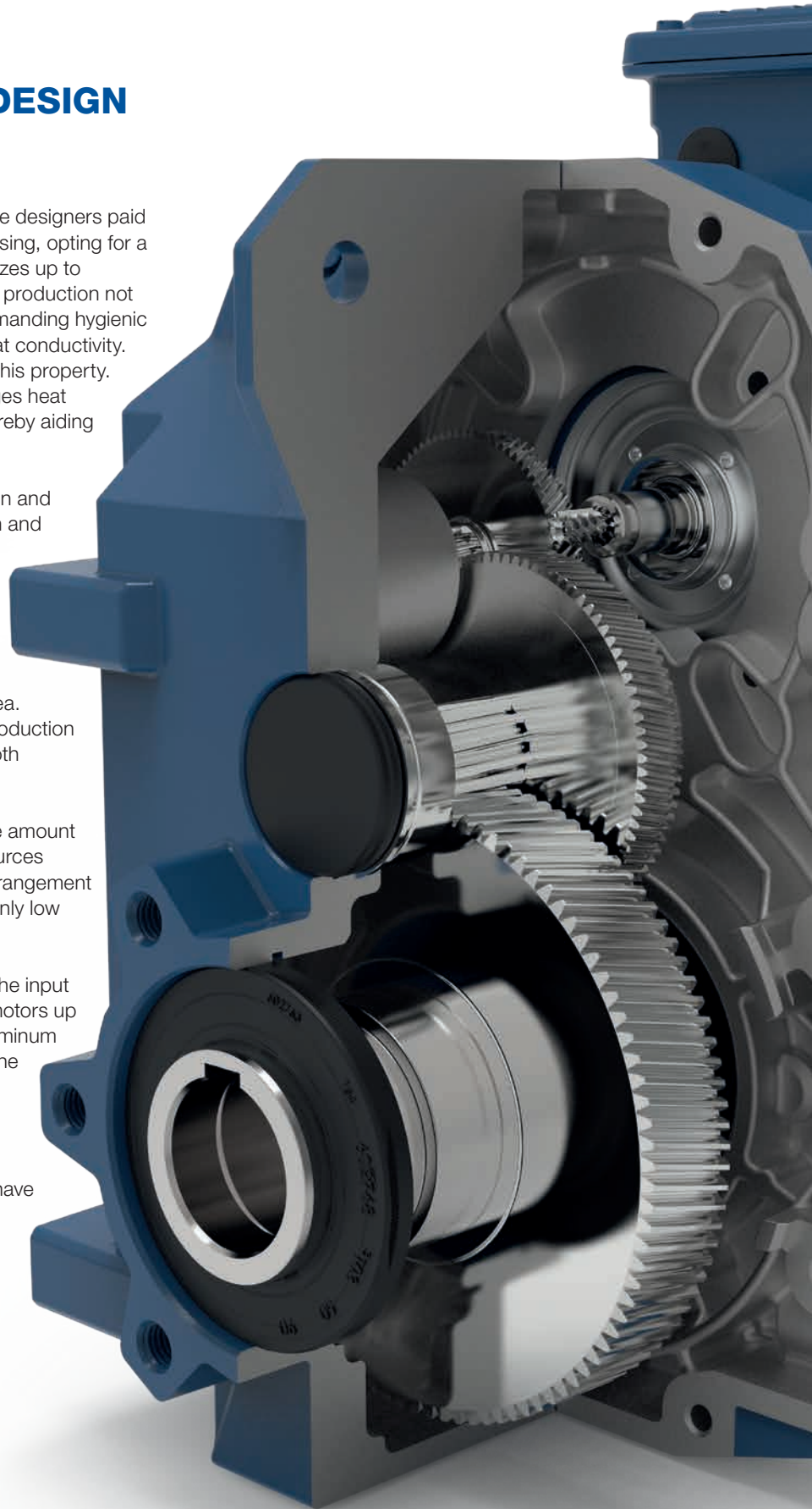

Helical geared motors C

The helical gearboxes come in twelve housing sizes for nominal torques from 440 to 159,000 lb-in and are available in both foot and flange designs. While the two smaller gearboxes (C00 and C01) are able to perform to their full potential with just two stages, the larger sizes C03 to C08 are available in both two or three stages for applications in higher torque ranges. From C09 there is an additional fourth stage, while the C16 is even equipped with 5 gear stages.

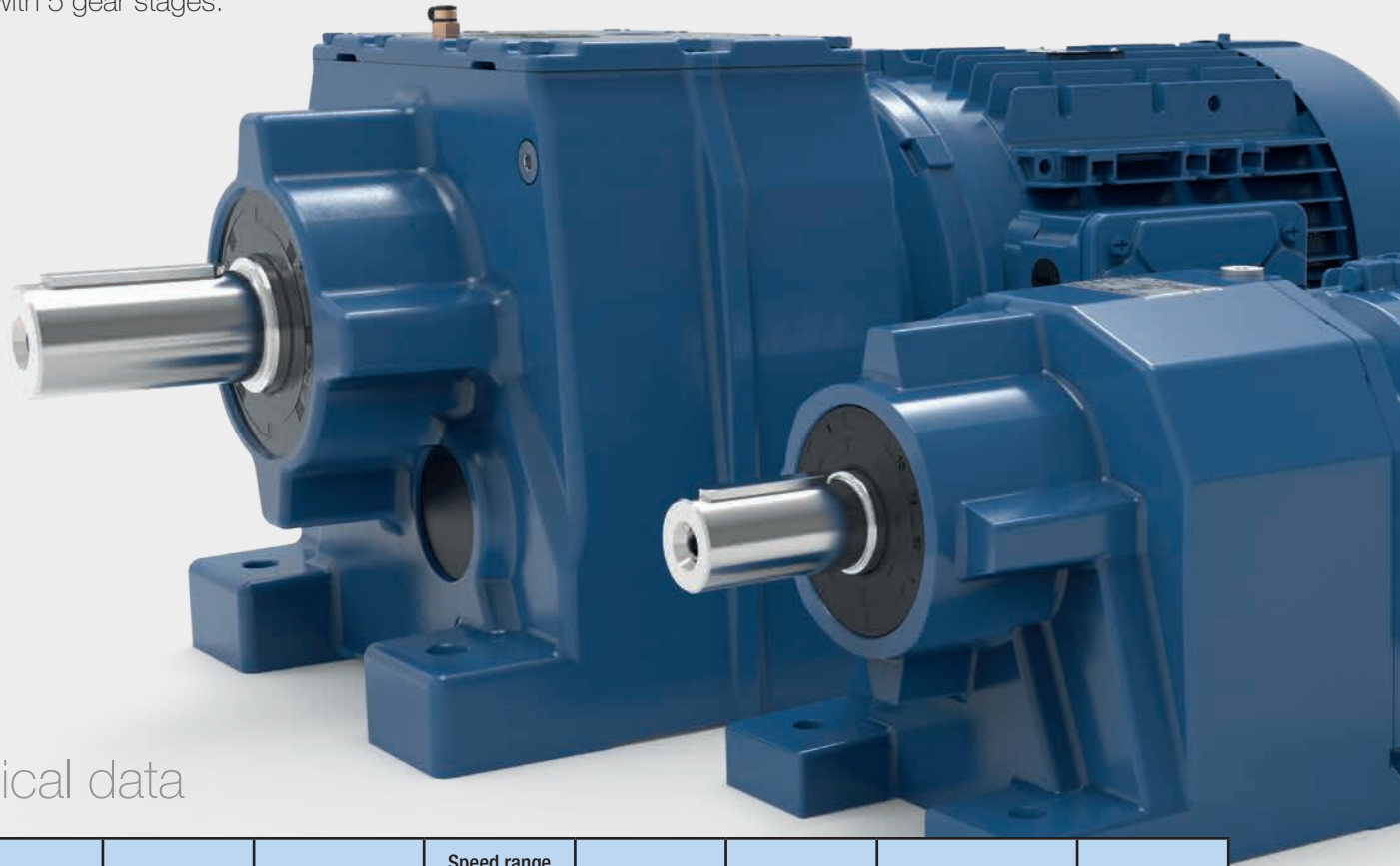

Technical data

	Nominal torque [lb-in]	Number of stages	Ratio range	Speed range at 1750 rpm 60 Hz [rpm]	Power range 60 Hz [hp]	Output shaft [in]	Output flange IEC [mm]	Housing material
C00	440	2	2.44 - 47.44	37 - 716	0.16 - 1.0	0.750 x 1.57	120/140/160	Aluminum
C01	750	2	3.09 - 66.50	26 - 565	0.16 - 2.0	0.750 x 1.57	120/140/160	
C03	1,770	2 / 3	2.91 - 286.32	6 - 601	0.16 - 4.0	1.000 x 1.97	120/140/160/200	
C05	3,540	2 / 3	2.52 - 328.43	5 - 694	0.16 - 10.0	1.250 x 2.36 1.375 x 2.76	160/200/250	
C06	5,310	2 / 3	2.80 - 375.71	5 - 625	0.16 - 12.5	1.375 x 2.76	200/250	
C07	7,260	2 / 3	2.59 - 351.33	5 - 675	0.16 - 20	1.625 x 3.15	250/300	
C08	13,700	2 / 3	2.69 - 368.94	5 - 650	0.16 - 30	2.125 x 3.94	300/350	
C09	26,600	2 / 3 / 4	2.99 - 3282.02	0.5 - 585	0.16 - 40	2.375 x 4.72	350/450	
C10	39,800	2 / 3 / 4	3.11 - 2636.78	0.7 - 562	0.16 - 50	2.875 x 5.51	350/450	
C13	70,800	2 / 3 / 4	4.00 - 1891.77	0.9 - 438	0.16 - 75	3.625 x 6.69	450/550	
C14	115,000	2 / 3 / 4	5.17 - 2162.84	0.8 - 339	0.16 - 75	4.375 x 8.27	450/550	
C16	159,000	2 / 3 / 4 / 5	5.96 - 22405.25	0.1 - 294	0.16 - 150	4.750 x 8.27	550/660	

Design versions

Foot



Flange

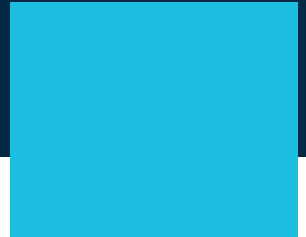
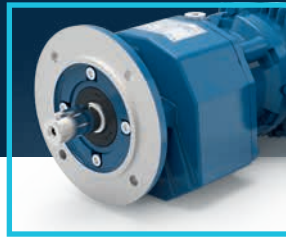

Standard mounting dimensions

Taking the most significant standard mounting dimensions available into account, the design allows for easy integration of WG20 geared motors into almost any existing system.

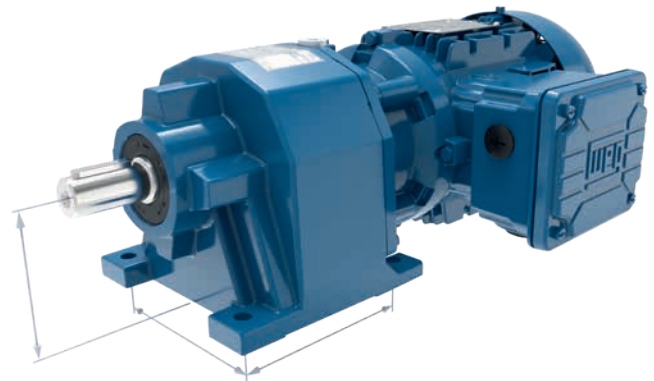

Typical areas of application

Machines for timber processing companies, presses, conveyor belts, rotary tables, pumps, packaging machines, bakery equipment, lifts, looms, screw conveyors and screw compressors.

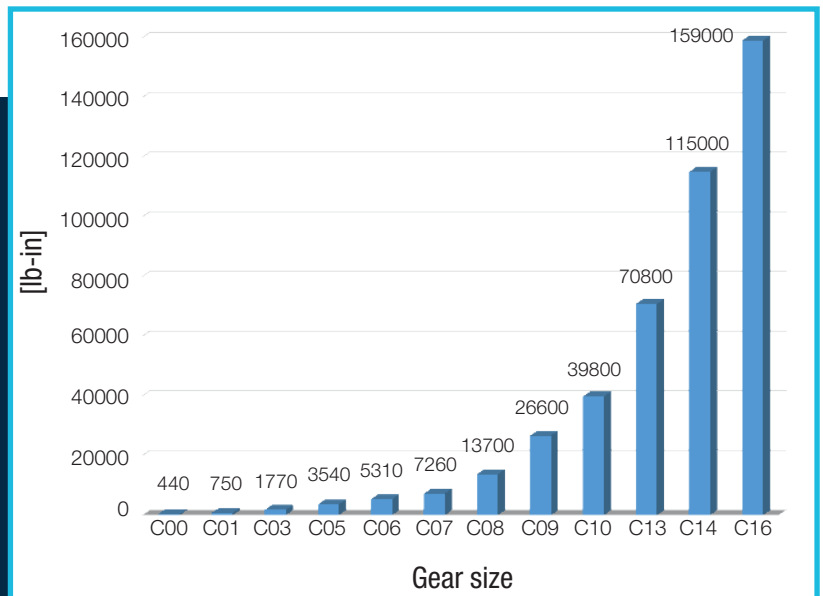

Parallel shaft geared motors F

Thanks to their structural design, parallel shaft gearboxes are particularly suitable for conveyor technology applications. All eleven sizes can be fitted with either a hollow shaft, output shaft, mounting flange and shrink disc or EasyLock system. The ratio range of gearbox sizes F04 to F15 can be extended by a third, from F08 by a fourth and with size F15 even with a fifth gear stage.

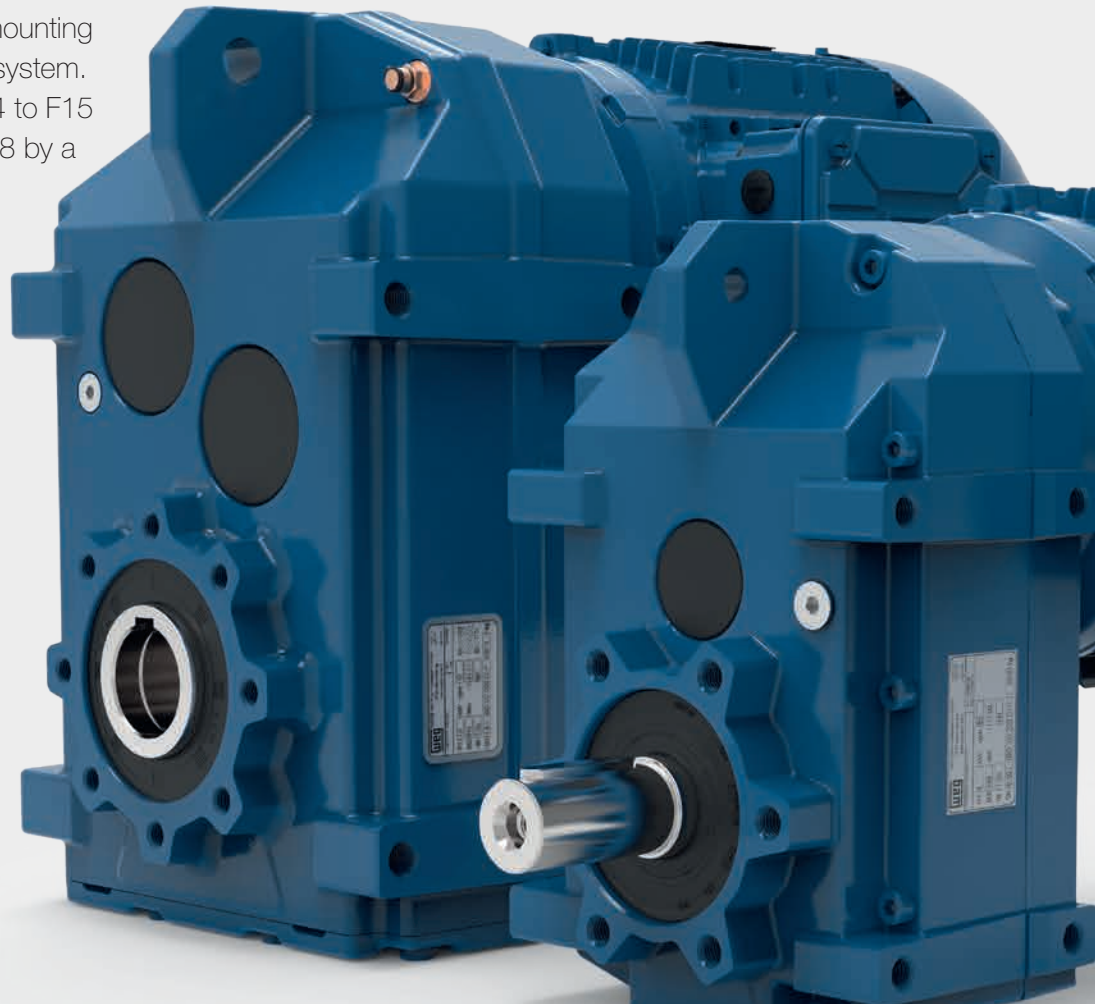

Technical data

	Nominal torque [lb-in]	Number of stages	Ratio range	Speed range at 1750 rpm 60 Hz [rpm]	Power range 60 Hz [hp]	Output shaft/ Ø hollow shaft [in]	Output flange IEC [mm]	Housing material
F02	1150	2	3.93 - 97.85	18 - 446	0.16 - 2.0	1.000 x 1.97 / 1.000	160	Aluminum
F03	1950	2	3.85 - 70.17	25 - 455	0.16 - 4.0	1.000 x 1.97 / 1.250	160	
F04	3540	2 / 3	4.26 - 422.98	4 - 411	0.16 - 4.0	1.250 x 2.36 / 1.375	200	
F05	5310	2 / 3	4.98 - 487.67	4 - 351	0.16 - 12.5	1.375 x 2.76 / 1.500	250	
F06	7260	2 / 3	4.41 - 412.64	4 - 396	0.16 - 20	1.625 x 3.15 / 1.500	250	Cast iron
F07	13280	2 / 3	4.29 - 385.37	5 - 408	0.16 - 20	2.000 x 3.94 / 2.000	300	
F08	26600	2 / 3 / 4	4.09 - 3836.13	0.5 - 428	0.16 - 30	2.375 x 4.72 / 2.375	350	
F09	39800	2 / 3 / 4	4.16 - 3086.96	0.6 - 421	0.16 - 50	2.875 x 5.51 / 2.750	450	
F10	70800	2 / 3 / 4	4.38 - 2276.77	0.8 - 400	0.16 - 75	3.625 x 6.69 / 3.625	450	
F12	115000	2 / 3 / 4	4.64 - 2307.03	0.8 - 377	0.16 - 75	4.375 x 8.27 / 4.000	550	
F15	159000	2 / 3 / 4 / 5	5.84 - 24805.81	0.1 - 299	0.16 - 150	4.750 x 8.27 / 4.500	660	

Design versions

Hollow shaft



Output shaft

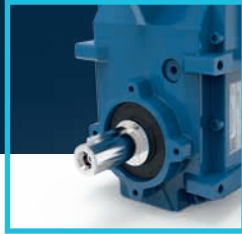

Flange

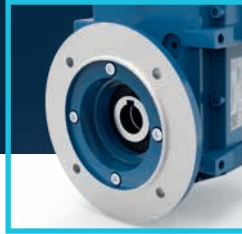

Shrink disc



EasyLock

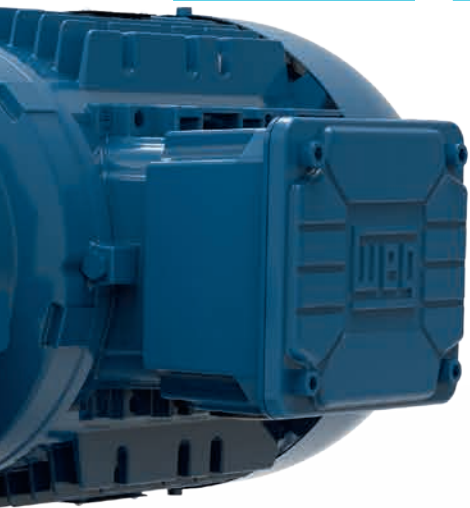

Standard mounting dimensions

Taking the most significant standard mounting dimensions on the market into account, the design allows for the easy integration of WG20 geared motors into almost any existing systems.

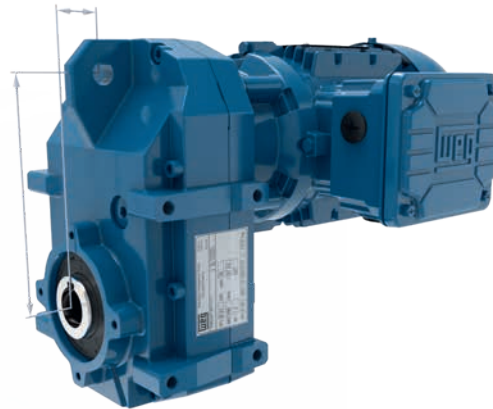

Typical areas of application

Machines for waste disposal and recycling, roller conveyors and laminating machines, machinery for timber processing companies, agitators, mixing equipment, stacking equipment, separators, screw conveyors, travel drives for cranes, welding equipment and surface aerators.

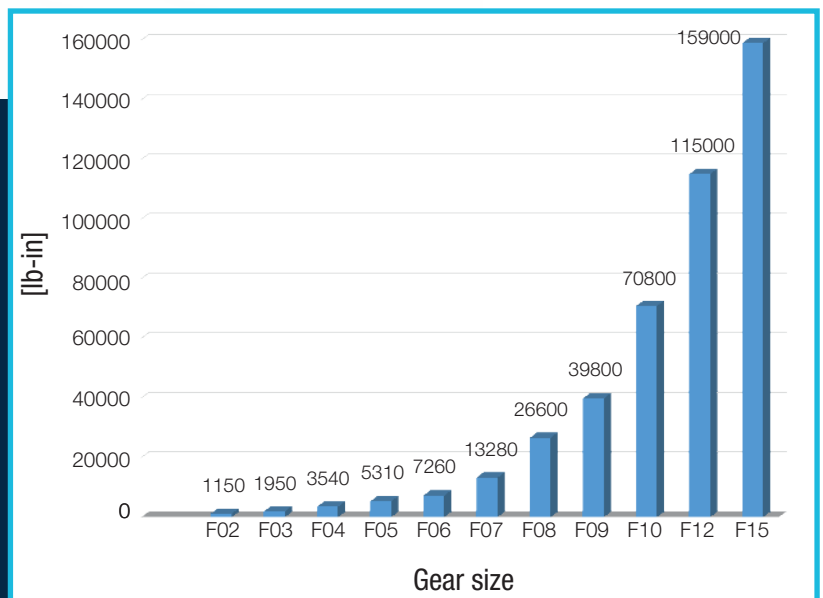

Helical bevel geared motors K

Helical bevel geared motors are suitable for a multitude of applications. The two-stage basic design is extended by a third gear stage upward of 1770 lb-in, a fourth upward of 26600 lb-in and a fifth at 159000 lb-in. K geared motors can also be equipped with a hollow shaft, output shaft, shrink disc or EasyLock system, torque arm and mounting flange.

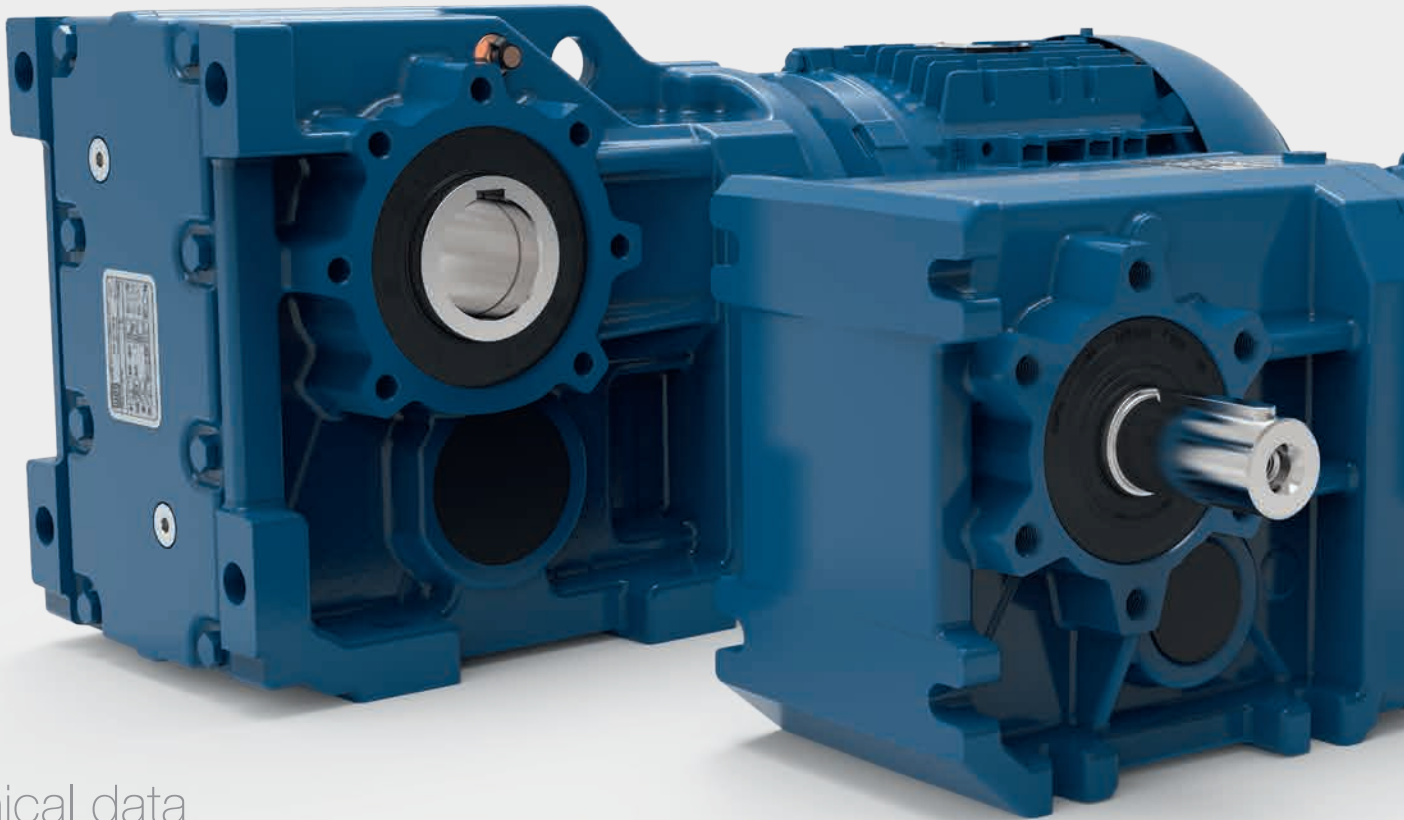

Technical data

	Nominal torque [lb-in]	Number of stages	Ratio range	Speed range at 1750 rpm 60 Hz [rpm]	Power range 60 Hz [hp]	Output shaft/ Ø hollow shaft [in]	Output flange IEC [mm]	Housing material
K02	970	2	3.82 - 68.88	25 - 459	0.16 - 2.0	1.000 x 1.97 / 1.000	160	Aluminum
K03	1770	3	4.17 - 217.88	8 - 420	0.16 - 4.0	1.000 x 1.97 / 1.250	160	
K04	3540	3	4.87 - 277.79	6 - 359	0.16 - 5.5	1.250 x 2.36 / 1.375	200	
K05	5310	3	4.27 - 245.70	7 - 410	0.16 - 12.5	1.375 x 2.76 / 1.500	250	
K06	7260	3	4.94 - 198.00	9 - 354	0.16 - 12.5	1.625 x 3.15 / 1.500	250	
K07	13700	3	7.91 - 256.14	7 - 221	0.16 - 20	2.000 x 3.94 / 2.000	300	Cast iron
K08	26600	3 / 4	7.45 - 2205.52	0.8 - 235	0.16 - 30	2.375 x 4.72 / 2.375	350	
K09	39800	3 / 4	6.94 - 1810.95	1 - 252	0.16 - 50	2.875 x 5.51 / 2.750	450	
K10	70800	3 / 4	6.64 - 1301.54	1 - 264	0.16 - 75	3.625 x 6.69 / 3.625	450	
K12	115000	3 / 4	6.60 - 1579.81	1 - 265	0.16 - 100	4.375 x 8.27 / 4.000	550	
K15	159000	3 / 4 / 5	8.61 - 14005.40	0.1 - 203	0.16 - 150	4.750 x 8.27 / 4.500	660	

Design versions

Hollow shaft



Output shaft

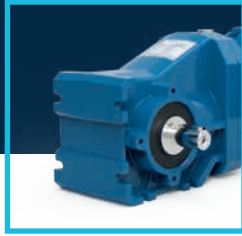

Flange

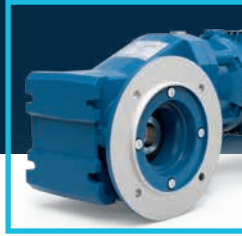

Shrink disc & torque arm

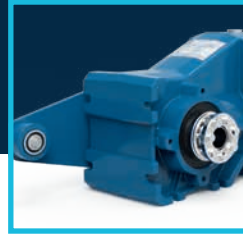

EasyLock

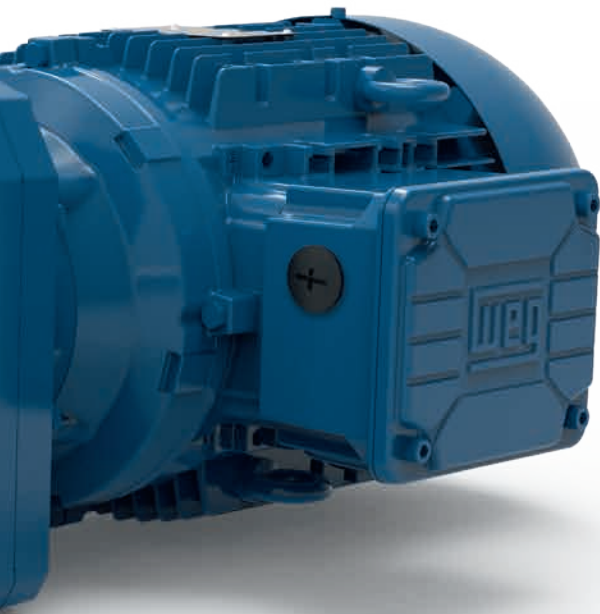
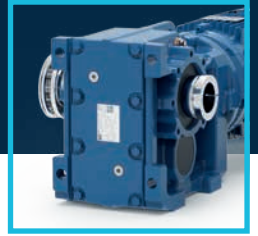

Standard mounting dimensions

Taking the most significant standard mounting dimensions on the market into account, the design allows for easy integration of WG20 geared motors into almost any existing system.

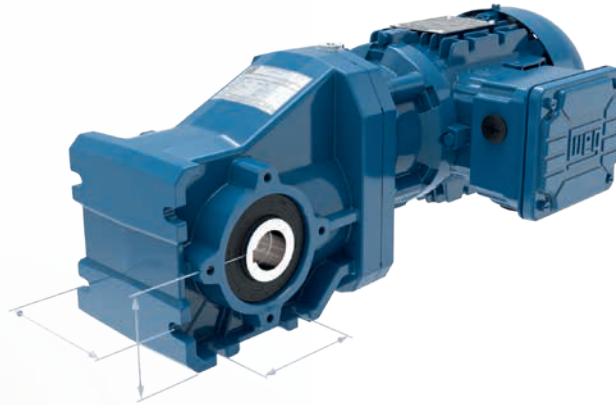

Typical areas of application

Roller tables and laminating machines, agitators, winches, lifts, heavy duty conveyors for bulky goods, shredders, conveyor belts, baggage handling systems, scenery lifts for stage machinery, bulk material and unit conveyors, and concrete mixing plants.

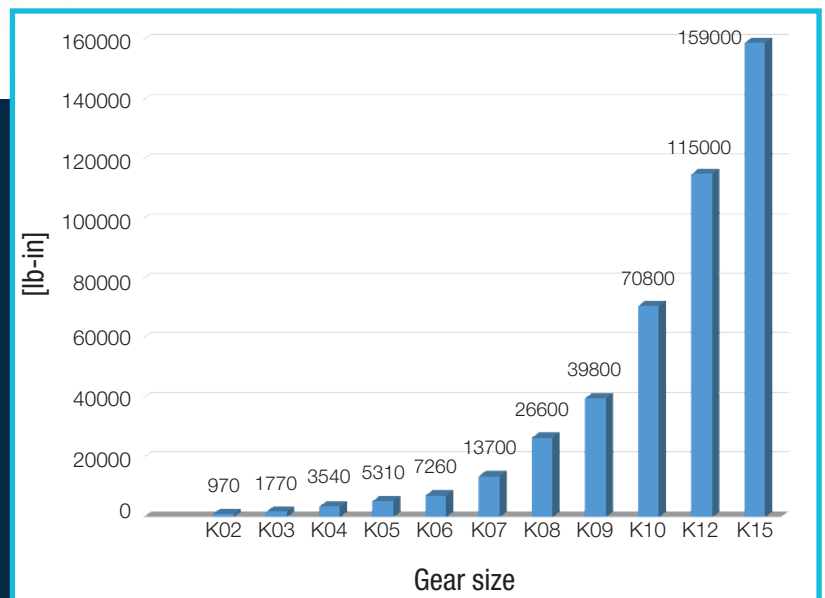

Helical worm geared motors S

WG20-S features a 2-stage design with significantly higher efficiency levels compared to mere worm gearboxes. The advantages of a right-angle gearbox in combination with numerous output and input variants provide a cost-effective alternative for the end user. Quiet running, overload capacity, compact design and a large speed/reduction range make these geared motors indispensable in modern drive concepts.

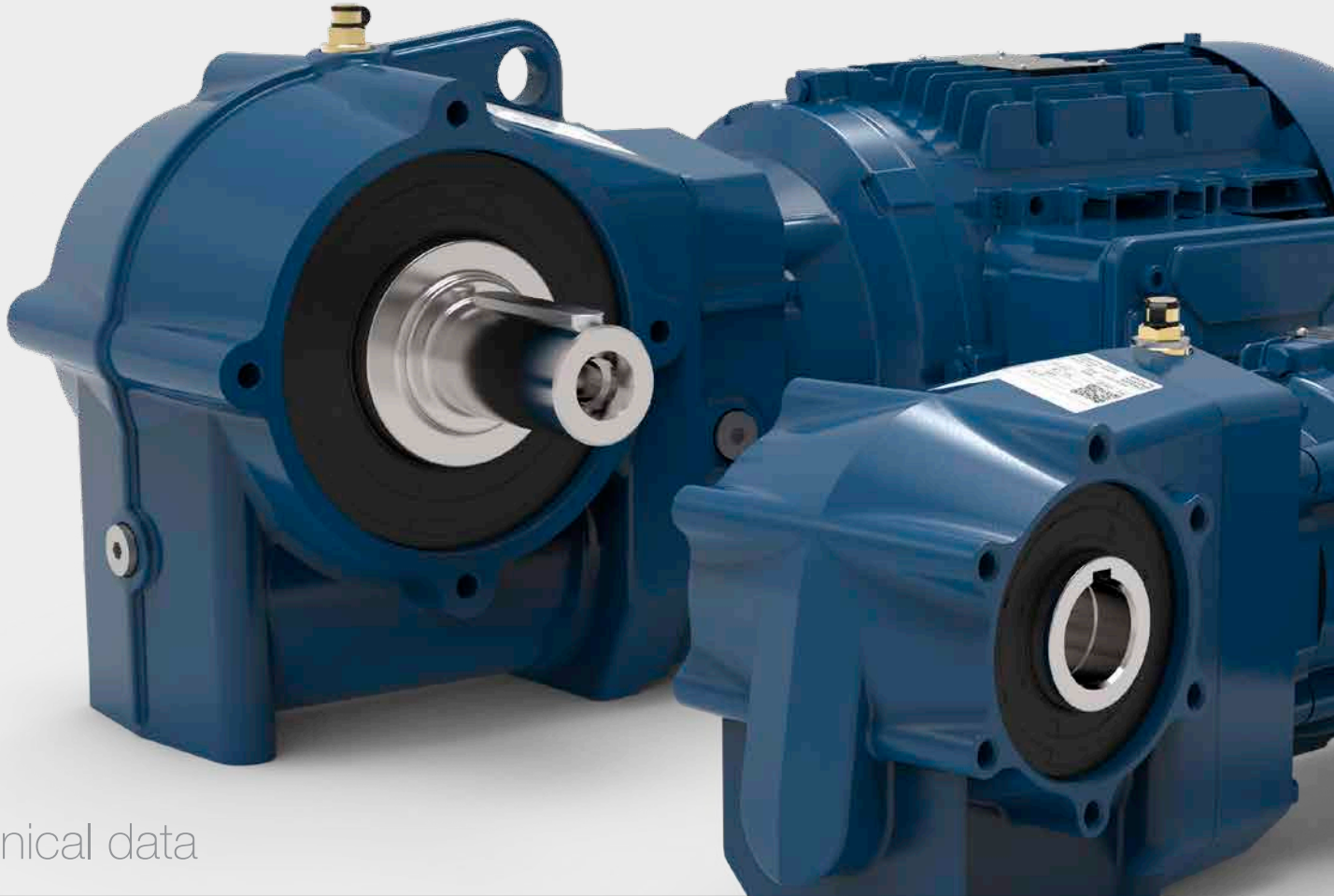

Technical data

	Nominal torque [lb-in]	Number of stages	Ratio range	Speed range at 1750 rpm 60 Hz [rpm]	Power range 60 Hz [hp]	Output shaft/ Ø hollow shaft [in]	Output flange IEC [mm]	Housing material
S03	1110	2	5.17 - 275.50	6 - 329	0.16 - 2.0	0.750 x 1.57 / 0.750	120 / 160	Aluminum
S04	2020	2	6.92 - 323.70	5 - 246	0.16 - 3.0	1.000 x 1.97 / 1.250	160	
S05	4330	2	9.33 - 370.50	5 - 182	0.16 - 4.0	1.250 x 2.36 / 1.375 1.188 1.250 1.438	200	
S06	8820	2	7.07 - 351.00	5 - 241	0.16 - 7.5	1.375 x 2.76 1.625 x 3.15 / 1.500	200	Cast iron
S07	14100	2	9.68 - 460.00	4 - 176	0.16 - 12.5	1.750 x 3.54 2.000 x 3.94 / 2.000	250	

Design versions

Hollow shaft

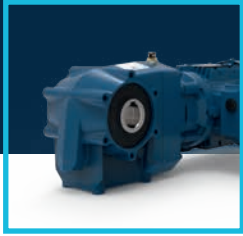

Output shaft

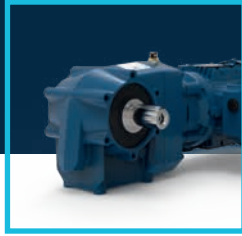

Flange

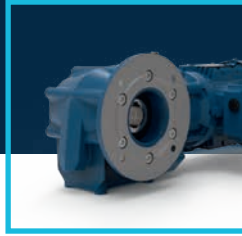

Shrink disc & torque arm

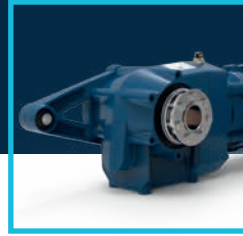

EasyLock

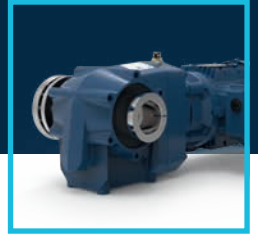

Standard mounting dimensions

Taking the most significant standard mounting dimensions on the market into account, the design allows for easy integration of WG20 geared motors into almost any existing system.

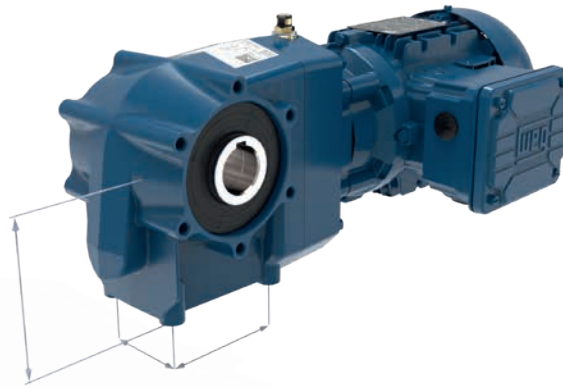
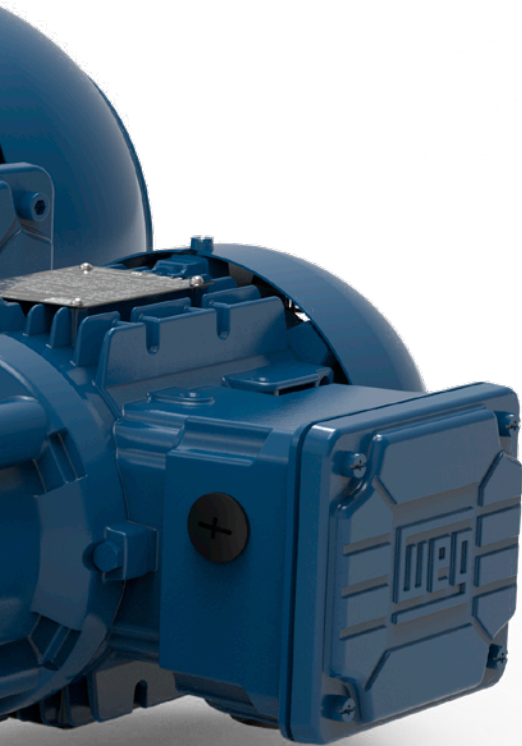

Typical areas of application

Small conveyor belts, airport logistics, screw conveyors for heating systems, bakery machines, beverage bottling plants, cable winch drives, travel drives and warehouse logistics.

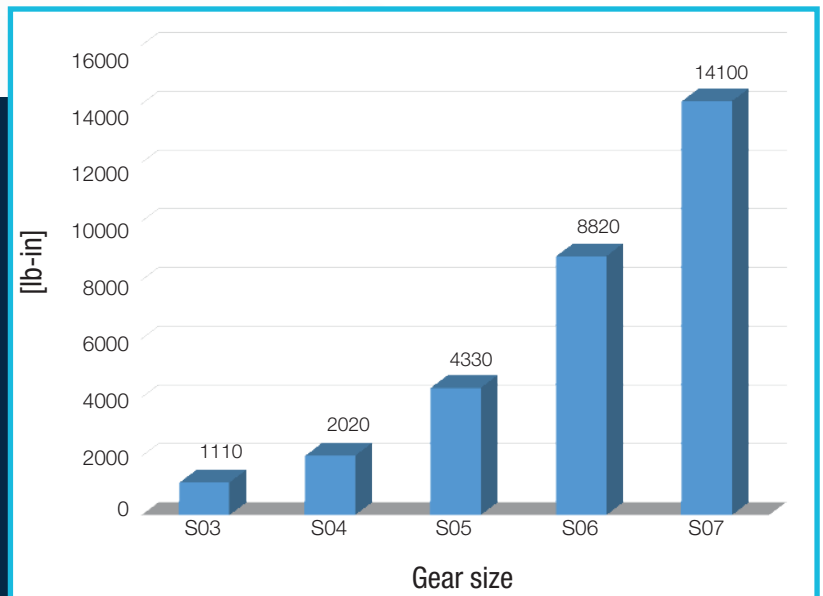

Modular INTEGRAL MOTOR in aluminum

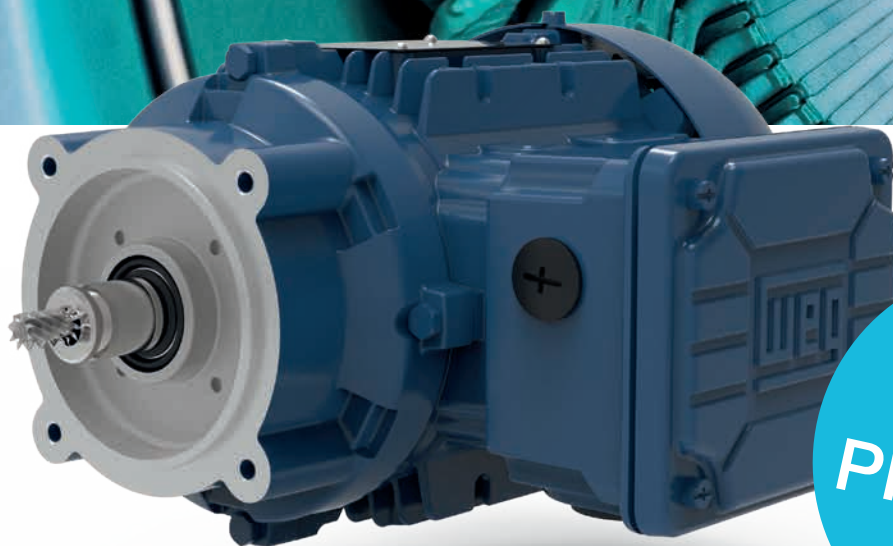

ALSO IN
**SUPER
PREMIUM**

Technical data (Standard)

		EUSAS		
Power output		0.16 - 0.75 hp	1.0 - 12.5 hp	0.16 - 7.5 hp
IEC frame sizes		63 - 80	80 - 132	63 - 132
Number of poles		4 and 6	4 (1.0 hp motor also 6)	4
Efficiency class		NEMA standard	NEMA Premium	NEMA Super Premium
Voltages	IEC frame size 63 - 100	265/460 V, 132/230 V		
	IEC frame size 112 - 132	460 V, 230/400 V		
Terminal board		9 bolts, 12 connection slots		
Inverter operation		up to 120 Hz		
Thermal class		F		
Protection class		IP55		
Housing material		aluminum		
Thermal protection		bi-metal switch and thermistor protection PTC		
Certificates		UL/GSA, CE, UKCA, EAC		

The latest generation of WEG asynchronous aluminum motors up to frame size 132 excels due to the user-friendly design up to NEMA Super Premium and the reliable quality in various industrial sectors.

The optimized design of the end shields and aluminum terminal box also results in a crucial reduction in weight.

Thanks to the special wide-range winding and nine-bolt terminal block, flexible use of the EUSAS motor is guaranteed anywhere in the world.

Modular INTEGRAL MOTOR in cast iron



ALSO IN
**SUPER
PREMIUM**

Technical data (Standard)

	EUSAS	
Power output	15 - 75 hp	10 - 150 hp
IEC frame sizes	160 - 225	132 - 280
Number of poles	4	
Efficiency class	NEMA Premium	NEMA Super Premium
Voltages	460 V, 230/400 V	
Terminal board	9 bolts, 12 connection slots	
Inverter operation	up to 120 Hz	
Thermal class	F	
Protection class	IP55	
Housing material	cast iron	
Thermal protection	thermistor protection PTC	
Certificates	UL/GSA, CE, UKCA, EAC	

The newly developed asynchronous integral motors in frame sizes 132 to 280 are members of the latest generation of the W22 motor family.

Due to their innovative design, these motors guarantee maximum value to the user and perform with highest efficiency and reliability.

The three-phase motors with power output of 10 to 150 hp are available up to energy efficiency class NEMA Super Premium, they can be mains operated and are certified for use in all important markets worldwide.

Motor features

EUSAS:

120 Hz characteristic - double the power

EUSAS modular motors from 0.16 to 150 hp are perfect for operation with electronic speed control. The 120 Hz voltage/frequency characteristic allows them to be operated in frequency inverter mode even without special windings. This allows the nominal output to be doubled without losing torque.

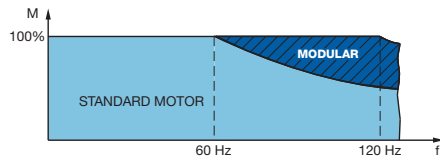

Rated (nominal) torque to double rated (nominal) speed

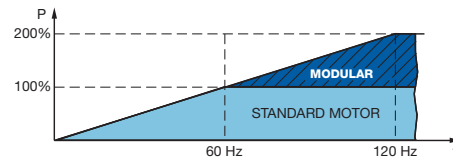

Double rated (nominal) power at twice the rated (nominal) speed

SIMPLY switch over for WORLDWIDE use

The special wide-range winding of the motor enables selection of up to four different voltage levels (star, delta, double star, and double delta) by means of twelve connection slots on the 9-bolt terminal block.

This allows modular motors to be used with almost any mains voltage and frequencies worldwide. Furthermore, the terminal box dimensions have been changed for ease of access.

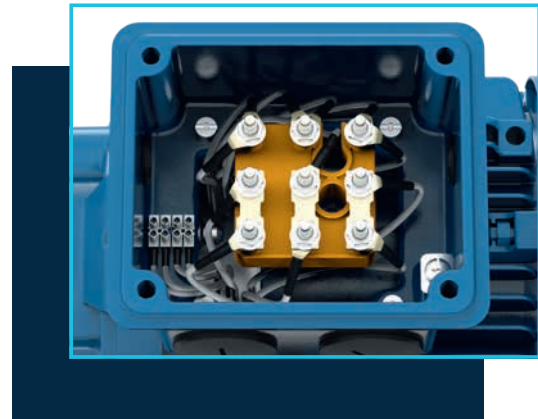

MOTOR MODULES for aluminum and cast iron motors

The particular advantage of the modular motor range is the ability to add system kits to the standard model, allowing a multitude of useful modules to be adapted to the customer's requirements.

Available motor modules include single and double brake systems, ventilation systems, extended terminal box systems, encoder systems (inside and outside the fan cover), backstops, protection caps, and hand wheel.

Spring loaded brake



Forced ventilation

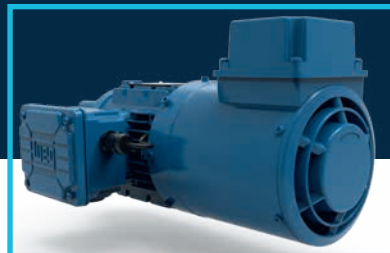

Incremental encoder (forced ventilation)



GEARED MOTORS for hazardous areas

The operation of machinery in areas with explosive air/gas or air/dust mixtures requires special measures. NEC article 500 specifies the minimum demands that must be met for electrical equipment, such as geared motors, in order to ensure safe operation.

WG20 gearboxes and geared motors meet all requirements of NEC article 500 for safe operation in Class I and Class II environments.

Division 2:

An area where ignitable concentrations of hazards are not likely to exist under normal operation conditions.

Division 1:

An area where ignitable concentrations of hazards can exist all of the time or some of the time under normal operation conditions.

Class I, Div 1, Group C and D
Class II, Div 1, Group F and G

Class I, Div 2, Group A, B, C and D
Class II, Div 2, Group F



GEARBOXES for a variety of motors

Even though our integral motors with top efficiency and power and wide voltage range are ideally suited for most applications, the operation of WG20 gearboxes is of course also possible with other WEG motors, as well as third-party and special motors on customer request.

Adapters for NEMA and IEC MOTORS

Standard motors according to NEMA C-FACE or according to DIN EN 50347 IM B5 can be mounted with suitable adapters. Depending on the size, the design is either a one-piece plug-in or a two-piece coupling adapter.

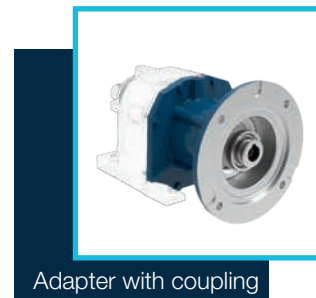
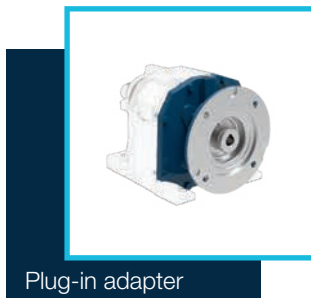

Adapters for SERVO MOTORS

Servo motors from a wide range of manufacturers can be mounted on WG20 gearboxes using SERVO adapters. The connection is made via flexible servo couplings and is suitable for both smooth shafts and motor shafts with key.

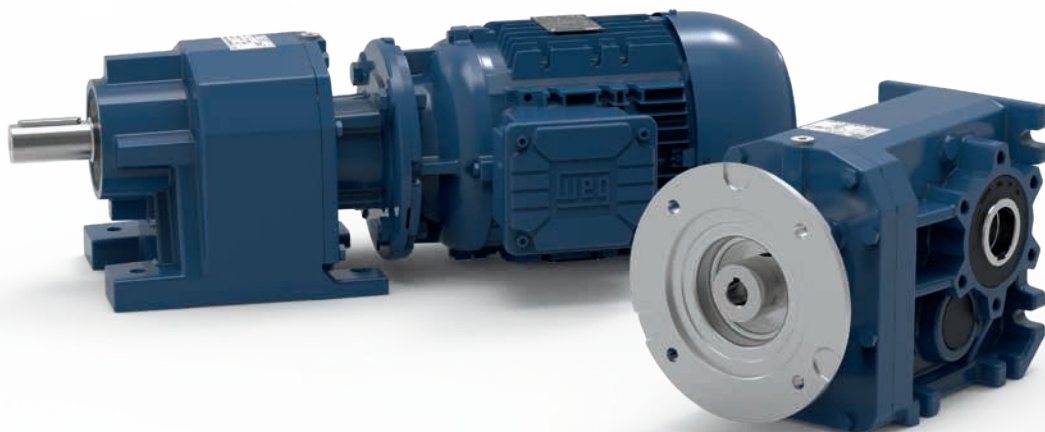

GEARED MOTORS with decentralized VFD

The greatest possible freedom and flexibility with a highly efficient and compact drive - that is the promise of combining a WG20 geared motor with the decentralized frequency inverter MW500. Compared to central solutions, a decentralized drive system can be networked more easily with common bus systems and can be installed and maintained faster with shorter cable lengths. This saves both costs and energy.



PANEL
not required



Reduced
INSTALLATION COSTS



Space saving and
flexible SOLUTION

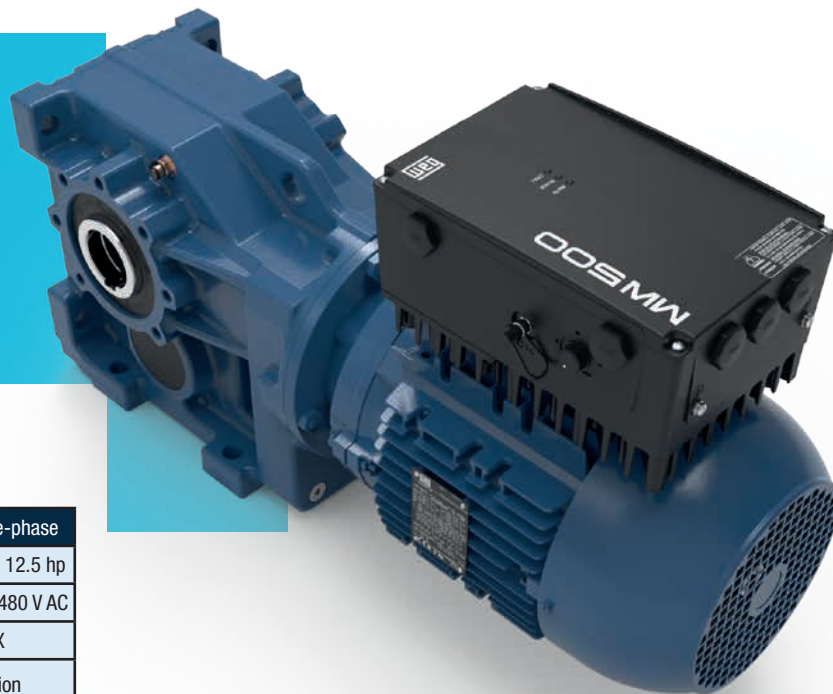

Technical data

	Single-phase	Three-phase
Power range	0.16 - 2.0 hp	0.16 - 12.5 hp
Voltage range	200 - 240 V AC	380 - 480 V AC
Protection class	IP66 / NEMA 4X	
Control	V/f speed regulation vector control (VVV)	
Dynamic braking	available as standard	
Connectivity	Profibus-DP, CANopen, DeviceNet, EtherNet/IP, Modbus-TCP, Profinet-IO, USB, RS485, RS232, Bluetooth	
Optional accessory	RFI filter, disconnect switch, remote HMI, flash memory module, I/O extension modules	

Special connector IP66
for HMI or external sensor



LED indicators and
optional disconnect switch

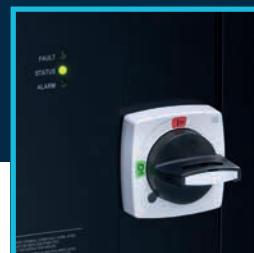

Built-in
analog potentiometer



FULL-SERVICE PROVIDER for drive solutions

WEG's product portfolio includes all important components for the industrial drive train. From gears and motors to control units, all elements are perfectly harmonized and guarantee maximum efficiency in operation and high-quality workmanship.

Variable speed drives CFW series



CFW320:
0.25 to 10 hp

CFW500:
0.16 to 150 hp

CFW900:
1.5 to 650 hp

Frequency inverters from WEG are the perfect addition for controlling the speed of three-phase asynchronous motors.

The range extends from the compact microdrive and the robust all-rounder to inverters that have been developed for special applications, e.g. pumps, HVAC, lifts, etc.

Extensive equipment and additional modules for communication interfaces offer flexibility and the use of state-of-the-art technology.

Soft starters SSW series

The soft starters from WEG enable smooth acceleration and deceleration of electric motors. The combination of innovation and functionality makes them the right choice for use in industrial applications.



SSW900:
3 to 1300 hp; 220 to 690 VAC; 10 to 1400 A; removable bluetooth keypad, pump control, fire mode, various communication protocols; ...

For the entire WEG product portfolio, please visit the website www.weg.net.



Digital solutions

WEG Scan

With the digital monitoring and diagnostic devices, operating data of motors and gearboxes can be called up at the touch of a button. Possible damage can be detected early and unplanned downtimes can be avoided.

Industrial gearboxes

WG50

Although WG20 covers a very wide range of applications, there are areas of use that require even higher torques. With the WG50 industrial gearbox series, WEG offers parallel shaft and helical bevel gearboxes with a torque of up to 4,600,000 lb-in.

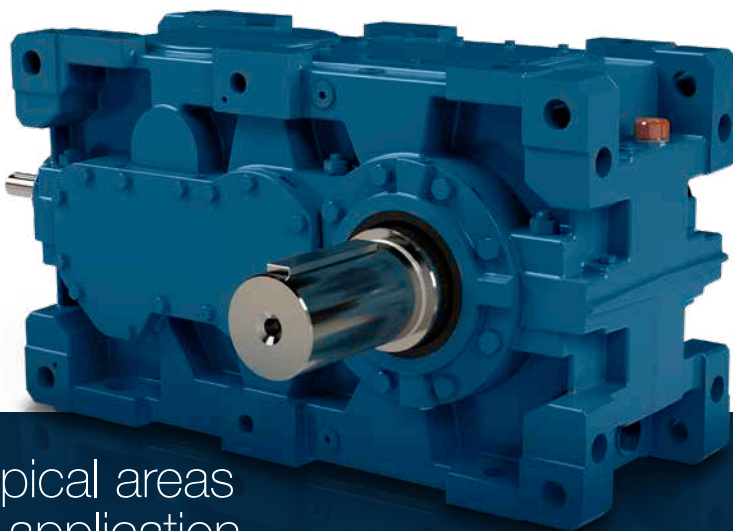

Typical areas of application

Mining, steel industry, conveyor technology, environmental technology, wood and paper industry, food industry and cooling towers.

Technical data

	WG50
Nominal torque	66,000 - 4,600,000 lb-in
Number of stages	2 / 3 / 4
Ratio range	6.3 - 450
Speed range	2.2 - 291 rpm
Housing material	Spheroidal graphite cast iron
Optional accessory	Backstop Torque arm Cooling



www.cat4cad.com

Easy product selection

The “cat4CAD®” product configuration tool makes it easy to interactively select products. Comprehensive wizards, user-friendly navigation and many other extra features allow quick configuration of the required drive.

ADVANTAGES

- Extensive product library
- Fast configuration of motors and geared motors
- Creation of project files with comprehensive technical documentation
- Easy modification of generated product data by means of the project file
- Quick request times

FEATURES

- The entire menu is available in many languages.
- To-scale 2D/3D drawings and PDF and DXF dimension sheet drawings of the previously selected drive.
- The 2D/3D data can be exported for use in standard CAD programs.
- Comprehensive technical data sheets of the configured gearbox and motor at the click of a button.
- The project file allows complete management of previously selected drives on one screen.
At the click of a button one can save or print this project file, create PDF and DXF dimension drawings and send inquiries directly to our sales team.

SEE THE ONLINE VERSION AT www.cat4cad.com

DOWNLOAD THE OFFLINE VERSION AT www.weg.net/at/cat4cad

Advantages for you



A geared motor **FOR THE WHOLE WORLD**

- Standard mounting dimensions
- Can be switched to different voltages around the world
- Certifications for international markets



Sophisticated design **FOR MORE EFFICIENCY**

- Wide speed range
- High efficiency
- Low noise levels
- Optimized oil fill quantity
- Maintenance-free and lubricated for life up to 5310 lb-in
- High quality components and equipment
- Motors to NEMA Super Premium efficiency



Comprehensive equipment **FOR MORE FLEXIBILITY**

- Can be extended by different motor modules
- Temperature monitoring without added costs
- Protection degree IP55 for the standard design
- Switchover to 120 Hz characteristic in frequency inverter operation



The optimal program **FOR LOWER COSTS**

- Reduction in operating costs for plant operators
- Standard mounting dimensions enable easy interchangeability without system conversion
- Low maintenance costs
- Flexibility and savings for purchasing, technology and warehousing



One company **FOR MORE SERVICE**

- Complete drive applications from WEG
- Global WEG branches and sales partners
- Short delivery times
- Innovative product configuration tool

The scope of solutions of the WEG Group is not limited to the products and solutions presented in this brochure.

**Please contact us
to learn more about our entire portfolio.**

**For our worldwide
operations visit our websites**



www.weg.net/us



 +1-800-ASK-4WEG

 info-us@weg.net

 WEG Electric Corporation
6655 Sugarloaf Parkway
Duluth, GA 30097

Cod: 50119822 | Rev: 14 | Date (m/y): 11/2024.

The values shown are subject to change without prior notice.