

Software

SuperDrive 8.0.0.3041

User's Manual

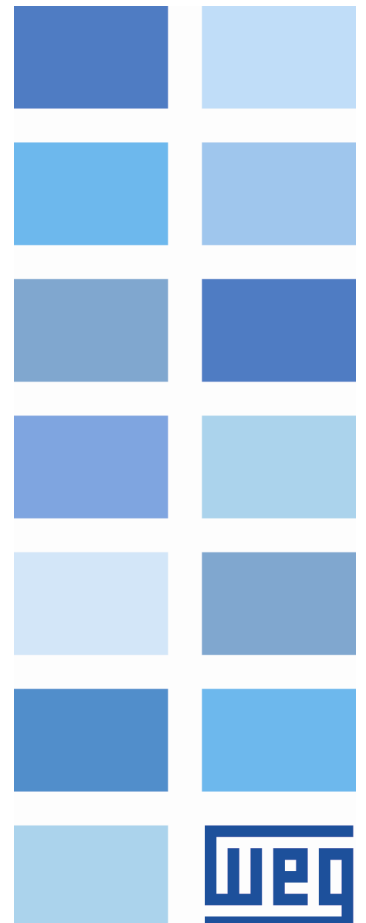



User's Manual

Series: SuperDrive

Language: English

Document: 10001830633 / 02

Publication Date: 08/2016

Content

1	SuperDrive 8.0.0.3041	6
2	Introduction	7
1	Welcome	7
2	System Requirements	7
3	Supported Drives	8
4	Copyright Notice	14
5	User's Manual - PDF	14
3	What's New	15
1	What's New - This Version	15
2	What's New - Previous Versions	15
4	Installation/Uninstallation	17
1	Before Installing SuperDrive	17
2	Installing SuperDrive	17
3	Uninstalling SuperDrive	18
5	SuperDrive Structure	19
1	SuperDrive Architecture	19
2	Project Architecture	20
6	Menus	22
1	Project	23
	New	23
	Open	23
	Close	24
	Save As	24
	Remove	24
	Print Setup	25
	Print	25
	Exit	26
2	View	26
	ToolBar	26
	DriveBar	26
	StatusBar	27
3	Offline	27
	Parameters	27
	Application Data	28
	Customer Data	28
	End User Data	29
	Drive Data	29
	Motor Data	29
4	Online	30
	Select Drive Address	30
	Read Parameters (Drive -> PC)	31

	Write Parameters (PC -> Drive)	31
	Monitor Parameters	32
	Monitor Using Keypad	32
	Monitor Parameters using Modem	33
	Acquire Parameter	38
	View Chart	40
	Online Graph	41
	Trace Function	42
	Error Log	46
	Identify Drives	46
	Communication Settings	47
5	Macros	48
	Basic Application	48
	Always Local Command	49
	Always Remote Command	50
	Multispeed with Commands via Digital Inputs	52
	Local/Remote Command with Selection via HMI	53
	Local Command with Reference via HMI and 3-Wire Start/Stop	54
6	Tools	55
	Drives Network	55
	Update Parameters to Other Firmware Version	55
	Language	56
	Options	57
7	Help	58
	Topics	58
	Technical Support	58
	Safety Warning	59
	License	59
	About SuperDrive	59
7	Wizards	61
1	Initial Power-up Wizard	61
2	Control Setting Wizard	61
3	Self-Tuning Wizard	61
8	Serial Communication	62
1	Drive Parametrization	62
2	Protocol	63
3	RS232	63
4	RS485	65
5	Adam 4520	67
6	IC109A	67
7	MIW-02	69
8	Serial Communication Errors	69
9	USB Serial Converter	70
9	Solving Problems	72
1	Printing Problem	72
2	Communication Problem	72

Index

74

1 SuperDrive 8.0.0.3041



Technical Support: Contact a local branch or representative.

Contact Us: <http://www.weg.net/>

Publication Date: 08/2016

Start

Click the Welcome button to start.



2 Introduction

Contents of this chapter:

Welcome

System Requirements

Supported Drives

Copyright Notice

User's Manual - PDF

2.1 Welcome

WELCOME TO SUPERDRIVE!

We thank you for using the SuperDrive, a windows graph tool for parameter setting, control and monitor of Drives.

It permits to edit directly in the drive online parameters, or to edit offline parameter files stored in the microcomputer.

It enables you to store parameters of all drives that exist in the installation.

The software also incorporates functions enable the upload to the drive of the microcomputer parameters sets as well as the download from the drive to the microcomputer.

The communication between drive and microcomputer is realized via RS232 serial interface (point to point) or by RS485 for network linkage.

The Main features are:

- Online identification of connected drive,
- Offline configuration of drive,
- Parameter transfer from PC to the drive,
- Parameter transfer from drive to the PC,
- Offline editing of the parameters stored on the PC,
- Online editing of the parameters in drive,
- Monitoring of the drive status,
- Command operations (motor stop/run, jog, forward/reverse, local/remote, etc),
- Supports multiple databases for standard and special firmware version,
- RS232 point-to-point serial communication,
- RS485 network serial communication,
- Graphical monitoring of parameters,
- Online help.

Note: some features are not available in all drives.

2.2 System Requirements

Item	Description
Processor	1 GHz or faster processor

Item	Description
Operating System	Windows 7 / 8 / 8.1 / 10 (x86, x64) with latest service pack available or upgrade You must have administrator privileges to install the software
Memory	Windows (x86) - 1 GB or more recommended Windows (x64) - 2 GB or more recommended
Display Color	High color resolution (16 bits) or more
Display Resolution	1024x768 pixels 1280x1024 pixels or higher-resolution screen recommended
Disk Space	100 MB of free disk space
Pointing Device	Mouse or compatible pointing device
Internet Browser	Mozilla Firefox 48 or greater
	Opera 38 or greater
	Safari 5.1 or greater
	Internet Explorer 8 / 9 / 10 (Windows 7)
	Internet Explorer 10 (Windows 8) Internet Explorer 11 (Windows 8.1) Internet Explorer 11 (Windows 10)
Communication	JavaScript enabled Browser should support Cascading Style Sheets (CSS1) and JavaScript RS232 Serial Interface

(x86) = 32-bit Edition.

(x64) = 64-bit Edition.

2.3 Supported Drives

The following table shows drives and firmware versions that each database supplied with SuperDrive supports.

Drive		SuperDrive
Model	Version	8.0.0
MVW-01	1.4X	X
	1.5X	X
	1.6X	X
	1.7X	X
	1.8X	X
	1.9X	X
	3.0X	X
	3.2X	X
	3.3X	X
CFW-09	1.2X	X
	1.4X	X
	1.6X	X
	1.77	X
	1.9X	X
	2.1X	X
	2.4X	X
	2.6X	X

Drive		SuperDrive
Model	Version	8.0.0
	3.1X	X
	3.3X	X
	3.7X	X
	4.0X	X
	4.4X	X
CFW-08	1.XX	X
	2.XX	X
	3.0X	X
	3.6X	X
	3.8X	X
	3.9X	X
	4.1X	X
	4.2X	X
	5.0X	X
5.2X	X	
CFW-07	2.XX	X
	3.XX	X
CFW-05	1.XX	X
	2.XX	X
	3.XX	X
	4.XX	X
	5.XX	X
SSW-05	2.0X	X
	2.1X	X
	2.2X	X
	2.3X	X
SSW-04	2.XX	X
	3.XX	X
	4.XX	X
	5.XX	X
	5.2X	X
	5.3X	X
	5.4X	X
SSW-03	2.XX	X
	3.XX	X
	4.XX	X
	5.XX	X
	5.1X	X
	5.2X	X
	5.3X	X
	5.4X	X
SCA-05	2.1X	X
	2.2X	X
	2.4X	X

Drive		SuperDrive
Model	Version	8.0.0
	2.7X	X
SCA-04	1.XX	X
	2.XX	X
	3.XX	X
	4.XX	
	4.0X	X
	4.1X	X
	4.2X	X
	1.0X	X
CTW-04	1.1X	X
	1.4X	X

NOTE!

- (1) SCA-05 2.1X - From version 2.11 and on.
- (2) MVW-01 1.4X - From version 1.41 and on.

As new firmware versions are created, additional databases are added to SuperDrive.

The additional databases can be found on the Internet at the manufacturer's web site (see SuperDrive 8.0.0.3041).

If your drive uses a special firmware version (customized version), SuperDrive needs an additional database. Request this additional database for the manufacturer.

The software allows communication only with the drive types listed in the above table.

Firmware is the software which controls the drive. To find out which is the firmware version, read parameter P0023.

Older Versions

The following table shows drives and firmware versions that each database supplied with SuperDrive supports.

Drive		SuperDrive						
Model	Version	5.70	5.80	5.90	5.91	6.00	6.10	7.0.0
CFW-09	1.2X	X	X	X	X	X	X	X
	1.4X	X	X	X	X	X	X	X
	1.6X	X	X	X	X	X	X	X
	1.77	X	X	X	X	X	X	X
	1.9X	X	X	X	X	X	X	X
	2.1X	X	X	X	X	X	X	X
	2.4X	X	X	X	X	X	X	X
	2.6X	X	X	X	X	X	X	X
	3.1X	X	X	X	X	X	X	X
	3.3X	X	X	X	X	X	X	X
	3.7X	X	X	X	X	X	X	X
	4.0X			X	X	X	X	X
4.4X						X	X	
CFW-08	1.XX	X	X	X	X	X	X	X
	2.XX	X	X	X	X	X	X	X
	3.0X	X	X	X	X	X	X	X
	3.6X	X	X	X	X	X	X	X
	3.8X	X	X	X	X	X	X	X
	3.9X	X	X	X	X	X	X	X
	4.1X	X	X	X	X	X	X	X
	4.2X		X	X	X	X	X	X
	5.0X			X	X	X	X	X
	5.2X				X	X	X	X
CFW-07	2.XX	X	X	X	X	X	X	X
	3.XX	X	X	X	X	X	X	X
CFW-05	1.XX	X	X	X	X	X	X	X
	2.XX	X	X	X	X	X	X	X
	3.XX	X	X	X	X	X	X	X
	4.XX	X	X	X	X	X	X	X
	5.XX	X	X	X	X	X	X	X
SSW-05	2.0X	X	X	X	X	X	X	X
	2.1X	X	X	X	X	X	X	X
	2.2X	X	X	X	X	X	X	X
	2.3X	X	X	X	X	X	X	X
SSW-04	2.XX	X	X	X	X	X	X	X
	3.XX	X	X	X	X	X	X	X
	4.XX	X	X	X	X	X	X	X
	5.XX	X	X	X	X	X	X	X
	5.2X	X	X	X	X	X	X	X

Drive		SuperDrive						
Model	Version	5.70	5.80	5.90	5.91	6.00	6.10	7.0.0
	5.3X	X	X	X	X	X	X	X
	5.4X	X	X	X	X	X	X	X
SSW-03	2.XX	X	X	X	X	X	X	X
	3.XX	X	X	X	X	X	X	X
	4.XX	X	X	X	X	X	X	X
	5.XX	X	X	X	X	X	X	X
	5.1X	X	X	X	X	X	X	X
	5.2X	X	X	X	X	X	X	X
	5.3X	X	X	X	X	X	X	X
	5.4X	X	X	X	X	X	X	X
SCA-05	2.1X	X	X	X	X	X	X	X
	2.2X	X	X	X	X	X	X	X
	2.4X	X	X	X	X	X	X	X
	2.7X			X	X	X	X	X
SCA-04	1.XX	X	X	X	X	X	X	X
	2.XX	X	X	X	X	X	X	X
	3.XX	X	X	X	X	X	X	X
	4.XX							
	4.0X	X	X	X	X	X	X	X
	4.1X	X	X	X	X	X	X	X
	4.2X	X	X	X	X	X	X	X
CTW-04	1.0X	X	X	X	X	X	X	X
	1.1X	X	X	X	X	X	X	X
	1.4X						X	X
MVW-01	1.4X	X	X	X	X	X	X	X
	1.5X	X	X	X	X	X	X	X
	1.6X		X	X	X	X	X	X
	1.7X				X	X	X	X
	1.8X					X	X	X
	1.9X						X	X
	3.0X							X
	3.2X							X
3.3X								

Drive		SuperDrive												
Model	Version	2.00	3.00	4.00	4.10	4.20	4.30	5.00	5.10	5.20	5.30	5.40	5.50	5.60
CFW-09	1.2X			X	X	X	X	X	X	X	X	X	X	X
	1.4X				X	X	X	X	X	X	X	X	X	X
	1.6X					X	X	X	X	X	X	X	X	X
	1.77							X	X	X	X	X	X	X
	1.9X						X	X	X	X	X	X	X	X
	2.1X									X	X	X	X	X
	2.4X									X	X	X	X	X

Drive		SuperDrive												
Model	Version	2.00	3.00	4.00	4.10	4.20	4.30	5.00	5.10	5.20	5.30	5.40	5.50	5.60
	2.6X											X	X	X
	3.1X												X	X
	3.3X													
	3.7X													
	4.0X													
	4.4X													
CFW-08	1.XX			X	X	X	X	X	X	X	X	X	X	X
	2.XX			X	X	X	X	X	X	X	X	X	X	X
	3.0X					X	X	X	X	X	X	X	X	X
	3.6X						X	X	X	X	X	X	X	X
	3.8X								X	X	X	X	X	X
	3.9X									X	X	X	X	X
	4.1X												X	X
	4.2X													
	5.0X													
	5.2X													
CFW-07	2.XX		X	X	X	X	X	X	X	X	X	X	X	X
	3.XX			X	X	X	X	X	X	X	X	X	X	X
CFW-05	1.XX			X	X	X	X	X	X	X	X	X	X	X
	2.XX			X	X	X	X	X	X	X	X	X	X	X
	3.XX	X		X	X	X	X	X	X	X	X	X	X	X
	4.XX		X	X	X	X	X	X	X	X	X	X	X	X
	5.XX			X	X	X	X	X	X	X	X	X	X	X
SSW-05	2.0X								X	X	X	X	X	X
	2.1X											X	X	X
	2.2X													
	2.3X													
SSW-04	2.XX			X	X	X	X	X	X	X	X	X	X	X
	3.XX			X	X	X	X	X	X	X	X	X	X	X
	4.XX				X	X	X	X	X	X	X	X	X	X
	5.XX					X	X	X	X	X	X	X	X	X
	5.2X											X	X	X
	5.3X											X	X	X
	5.4X													
SSW-03	2.XX			X	X	X	X	X	X	X	X	X	X	X
	3.XX			X	X	X	X	X	X	X	X	X	X	X
	4.XX				X	X	X	X	X	X	X	X	X	X
	5.XX					X	X	X	X	X	X	X	X	X
	5.1X											X	X	X
	5.2X											X	X	X
	5.3X											X	X	X
	5.4X											X	X	X
SCA-05	2.1X												X	X
	2.2X													

Drive		SuperDrive												
Model	Version	2.00	3.00	4.00	4.10	4.20	4.30	5.00	5.10	5.20	5.30	5.40	5.50	5.60
	2.4X													
	2.7X													
SCA-04	1.XX			X	X	X	X	X	X	X	X	X	X	X
	2.XX			X	X	X	X	X	X	X	X	X	X	X
	3.XX			X	X	X	X	X	X	X	X	X	X	X
	4.XX					X	X	X	X	X	X	X	X	X
	4.0X													
	4.1X													
	4.2X									X	X	X	X	X
CTW-04	1.0X										X	X	X	X
	1.1X										X	X	X	X
	1.4X													
MVW-01	1.4X													
	1.5X													
	1.6X													
	1.7X													
	1.8X													
	1.9X													
	3.0X													
	3.2X													
	3.3X													

- NOTE!**
- (1) SCA-05 2.1X - From version 2.11 and on.
 - (2) MVW-01 1.4X - From version 1.41 and on.

2.4 Copyright Notice

This computer program is protected by copyright law and international treaties. Unauthorized reproduction or distribution of this program, or any portion of it, may result in severe civil and criminal penalties, and will be prosecuted to the maximum extent possible under law.

2.5 User's Manual - PDF

The user's manual in PDF format can be found in the Help folder where SuperDrive is installed.

Example: C:\WEG\SuperDrive 8.0.0.3041\Help.

3 What's New

Contents of this chapter:

What's New - This Version

What's New - Previous Versions

3.1 What's New - This Version

SuperDrive 8.0.0.3041

08/11/2016

New Functions:

- Compatible with Windows 10 (x86 and x64);
- Added communication with MVW01 V3.3X;
- Access to System Information (displays detailed information of Windows) in about box.

Enhancements:

- MVW01: trace window with new interface;
- MVW01: alert message when P553 (sampling period for trace) has very low period;
- MVW01: fault and alarm list update;
- Communication with MVW01 V3.0x, including parameters for maintenance;
- Safety Warning window: can be accessed directly by menu item or icon;
- Safety Warning window: added checkbox to display / hide this window at startup of SuperDrive;
- Technical Support information: can be accessed directly by menu item or icon;
- License Agreement: can be accessed directly by menu item or icon;
- Alert message when the window will open outside the primary monitor now appears only once, whose user-defined action is applied throughout the session in progress (while SuperDrive is open);
- Main window: shows name and path of the open project.

Corrections:

- Database correction for MVW01 V1.9X;
- Database correction for MVW01 V3.0X;
- Database correction for MVW01 V3.2X;
- MVW01: Correction of P072 (Vab input voltage) and P073 (Vcb input voltage) in the trace function.

3.2 What's New - Previous Versions

SuperDrive 7.0.0

08/31/2015

New Functions:

- Compatible with Windows 8 / 8.1 (x86 and x64);
- Visualization / changing / printing of hidden parameters in MVW01 by password;
- Warning when the window will open outside the primary monitor;
- Communication with MVW-01 V3.0x;
- Communication with MVW-01 V3.2x.

Enhancements:

- Update Trace function of MVW01 (including new currents).

Corrections:

- Print error with some page sizes;

- Communication with MVW01 V1.9X.

SuperDrive 6.10

07/31/2012

New Functions:

- Communication with MVW-01 V1.8x;
- Communication with MVW-01 V1.9x;
- Communication with CTW-04 V1.4x;
- Communication with CFW-09 V4.4x.

SuperDrive 5.91

04/30/2009

New Functions:

- Communication with CFW-08 V5.2x;
- Communication with MVW-01 V1.7x.

4 Installation/Uninstallation

Contents of this chapter:

Before Installing SuperDrive

Installing SuperDrive

Uninstalling SuperDrive

4.1 Before Installing SuperDrive

Check the following items before installing SuperDrive:

- If the microcomputer meets the System Requirements.
- If SuperDrive version is compatible with your drive, see Supported Drives.

4.2 Installing SuperDrive

When installing a newer version of SuperDrive it is recommended that you first uninstall the previous version and re-boot your system to make sure the installation executes correctly.

Close all open programs currently running to prevent interference with the installation process.

To install SuperDrive, please follow the steps below.

INSTALLATION

1. You must be logged in as an administrator to install the program; if you're using a standard account, the application will fail to run;
2. If User Account Control (UAC) is enabled (Control Panel > User Accounts > Change User Account Control Settings), you will be notified before the installer starts the installation and try to make a change in the Windows configuration; click **Yes** to confirm that you allow the program to make changes to your computer, otherwise you can not install the program;
3. You should also run the installer with elevated privileges; to do so, right-click setup.exe installer displays a menu; click **Run as administrator**;
4. Click **Continue** if any incompatibility message appears;
5. On **Welcome** window, click **OK**;
6. On **Begin the installation** window, click **Click here to begin setup** (Click this button to install SuperDrive 8.0.0.3041 software to the specified destination directory) to install the software;
7. On **Select Program Group** window, click **Continue**;
8. The software will start the installation;
9. If a **Version Conflict** window appears, use the recommendation of the window; this usually occurs when the file to be installed is older than the current file in the system; click **Yes** to keep the current file in the system;
10. On the last window where the message "SuperDrive 8.0.0.3041 Setup was completed successfully" appears, click **OK** to exit.

4.3 Uninstalling SuperDrive

To uninstall SuperDrive, please follow the steps below.

UNINSTALLATION

NOTE!



As indicated below, use Programs and Features utility from control panel to remove SuperDrive. Do not manually delete files and folders.

1. In Control Panel, click **Programs and Features > SuperDrive 8.0.0.3041 > Uninstall**;
2. You must be logged in as an administrator to remove the program; if you're using a standard account, then you can not remove the software;
3. If User Account Control (UAC) is enabled (Control Panel > User Accounts > Change User Account Control Settings), you will be notified before starting the removal and try to make a change in the Windows configuration; click Yes to confirm that you allow the program to make changes to your computer, otherwise you can not remove the program;
4. On **Application Removal** window, click **Yes** to confirm you want to remove the program;
5. On **Shared Component** window (if it appears), select the best option for the question; normally select **Remove** if you are sure the file is not used by other programs, otherwise press **Keep**;
6. In the last window where the message "Program installation removed" appears, click **OK** to exit.

NOTE!

User Account Control:



- Windows Vista/7/8/8.1 = Control Panel > All Control Panel Items > User Accounts > Change User Account Control Settings.
- Windows 10 = Control Panel > All Control Panel Items > Security and Maintenance > Change User Account Control Settings.

5 SuperDrive Structure

Contents of this chapter:

SuperDrive Architecture

Project Architecture

5.1 SuperDrive Architecture

The SuperDrive is divided in directories and several files are part of the system.

SUPERDRIVE PATH

The SuperDrive is installed in one directory of the hard disk called as ...\\SuperDrive 8.0.0.3041.

DIRECTORY ...\\SuperDrive 8.0.0.3041

SuperDrive.exe
Main File of the SuperDrive

Chart.dll
Communicate.dll
Copy.dll
Data.dll
Document.dll
HMI.dll
IPowerup.dll
ProgressBar.dll
SDComm.dll
SelfTuning.dll
Tools.dll
Update.dll
VectorControl.dll
Libraries used by the SuperDrive.

DIRECTORY ...\\SuperDrive 8.0.0.3041\\Drivers

*P.wcd
Device driver in Portuguese of the drive

*E.wcd
Device driver in English of the drive

*S.wcd
Device driver in Spanish of the drive

*.def, *.ver
Definition files of SuperDrive.

DIRECTORY ...\\SuperDrive 8.0.0.3041\\Graphics

*.ico
Icon files.

*.bmp
Bitmap files.

*.jpg
Jpg files.

*.cur
Cursor files.

DIRECTORY...\SuperDrive 8.0.0.3041\Help

*.chm
SuperDrive Help Files.

DIRECTORY ...\SuperDrive 8.0.0.3041\Media

*.wav
Sound files.

5.2 Project Architecture

The project consists in a directory and a set of files.

PROJECT ARCHITECTURE

Each project is stored in the directory ...**SuperDrive 8.0.0.3041\Projects\XXXXXXXX** where **XXXXXXXX** is the name of the project.
All files are stored in this directory.

FILES

Each project is divided into several files in the project directory. The files are described below.

Project.sdp
Main project file.

XX.par
File with the content of the drive parameters in the address XX (01...30)

XX.rer
File with the occurred errors during drive read operation.

XX.wer
File with the occurred errors during drive write operation.

Application.app
File with the application data.

Customer.app
File with the customer data.

EndUser.app
File with the EndUser data.

XX.sdp
File with the drive data.

XX.mot

File with the motor data.

*.cht

File with the adquired points from drive.

XX.hmi

File with parameters stored in the EEPROM memory of the keypad.

.gol

File with the adquired points from drive.

.trc

File with the data stored by the Trace function, acquired from drive.

*.err

File with the register of errors stored in the drive.

6 Menus

Contents of this chapter:

Project

- New
- Open
- Close
- Save as
- Remove
- Print Setup
- Print
- Exit

View

- ToolBar
- DriveBar
- StatusBar

Offline

- Parameters
- Application Data
- Customer Data
- End User Data
- Drive Data
- Motor Data

Online

- Select Drive Address
- Read Parameters (Drive -> PC)
- Write Parameters (PC -> Drive)
- Monitor Parameters
- Monitor Using Keypad
- Monitor Parameters using Modem
- Acquire Parameter
- View Chart
- Online Graph
- Trace Function
- Error Log
- Identify Drives
- Communication Settings

Macros

- Basic Application
- Always Local Command
- Always Remote Command
- Multispeed with Commands via Digital Inputs
- Local/Remote Command with Selection via HMI
- Local Command with Reference via HMI and 3-Wire Start/Stop

Tools

- Drives Network
- Update parameters to other firmware version
- Language
- Options

Help

- Topics
- Technical Support
- Safety Warning
- License
- About SuperDrive

6.1 Project

New

Open

Close

Save as

Remove

Print Setup

Print

Exit

6.1.1 New

ACCESS

Menu: Project + New
Shortcut Key: Ctrl+N

FUNCTION

It creates a new project.

DESCRIPTION

Enter the name of the new project. If the selected name is valid, the project will be open after confirmed by the Ok button.
The cancel button does not created the project and closes the dialogue.

6.1.2 Open

ACCESS

Menu: Project + Open
Shortcut Key: Ctrl+O

FUNCTION

Opens an existing project.

DESCRIPTION

Select one of the existing projects from the project list and press Ok button or press with the left button of the mouse two times on the selected project.

The project will be opened automatically and the drive network window shows the drives that are configured in the project.

6.1.3 Close

ACCESS

Menu: Project + Close

Shortcut Key: -

FUNCTION

Closes the current project.

DESCRIPTION

When a project is closed, some menu items are disabled and thus those functions can not be accessed.

6.1.4 Save As

ACCESS

Menu: Project + Save as

Shortcut Key: -

FUNCTION

Saves the actual current project with other name.

DESCRIPTION

Enter the new name of the current project. If the chosen name is valid, the project will be open after confirmation by Ok button. The Cancel button does not save the project and closes the dialogue.

6.1.5 Remove

ACCESS

Menu: Project + Remove

Shortcut Key: -

FUNCTION

Removes the selected project.

DESCRIPTION

Select a project from the list of existing projects and press OK button. The user has to confirm project deletion before it is completely removed. OK button is disabled while no project is selected. Any project can be removed, including the active project (the one that is opened).

6.1.6 Print Setup

ACCESS

Menu: Project + Print Setup

Shortcut Key: -

FUNCTION

It changes the printer and the printing options.

DESCRIPTION

It permits the printer selection, changing the printing quality, paper, etc. It shows the standard dialogue box of the printing configuration with options to specify the printer, paper orientation, paper size and paper source, as well as other printing options.

6.1.7 Print

ACCESS

Menu: Project + Print

Shortcut Key: Ctrl+P

FUNCTION

Prints the project data.

DESCRIPTION

It prints the following project data:

- Application Data
- Customer Data
- End User Data
- Drive Data
- Motor Data
- Parameters

6.1.8 Exit

ACCESS

Menu: Project + Exit
Shortcut Key: -

FUNCTION

Closes the open project and quits the SuperDrive.

DESCRIPTION

All information and configuration are stored automatically.

6.2 View

ToolBar

DriveBar

StatusBar

6.2.1 ToolBar

ACCESS

Menu: Display + toolbar
Shortcut Key: -

FUNCTION

Shows and hides Toolbar.

DESCRIPTION

The Toolbar contains the icons corresponding to the menu items.

6.2.2 DriveBar

ACCESS

Menu: Display + DriveBar
Shortcut Key: -

FUNCTION

Shows or hides the drivebar.

DESCRIPTION

The drivebar contains the information about the selected drive: tag, address, type, firmware version, rated voltage, rated current and serial port.

6.2.3 StatusBar

ACCESS

Menu: display + Status bar
Shortcut Key: -

FUNCTION

Displays or hides the status bar.

DESCRIPTION

The status bar contains a field for system messages, status of the keys caps lock, num lock, insert and scroll lock, date and clock time.

6.3 Offline

Parameters

Application Data

Customer Data

End User Data

Drive Data

Motor Data

6.3.1 Parameters

ACCESS

Menu: Offline + Parameters
Shortcut Key: -

FUNCTION

Permits offline editing of the parameter content.

DESCRIPTION

The online editing consists in displaying/changing of the parameter content.
 The parameters will be displayed sequentially on a grade in ascending order. There are 2 arrows for vertical scroll that permits to scroll the window up and down.
 Columns form the grade that contains a note, parameter number, function, Adjustable Range, Factory Setting, User's Setting and Unit.
 The only field that can be changed on the grade is the User's Setting.
 Some parameters can not be changed, but only displayed (reading parameters)

Displaying

The user's setting field is updated automatically after user has made changes.

Changes

The user must click on the User's Setting field and fill in this field the desired value. After that he must press Enter or click on Ok button.

NOTE!



The value inserted in the grade by the user is not checked in this stage. Only when the user transfers the parameter content by using the function write to the drive, and when the parameter value is out of range, i.e., when the value is not numerical, etc., the user will be informed about this automatically when the writing process is finished.

Commands

Show/Hide - This command shows or hides the secondary parameter lines on the grid.
 Print - printing of the chart with all information contained in the window.
 Export - export parameters to Microsoft Excel.
 Ok - when this command is give, you exit the window.
 Help - this command opens a Help window.

6.3.2 Application Data

ACCESS

Menu: Offline + Application data
 Shortcut Key: -

FUNCTION

It permits displaying/changing application data.

DESCRIPTION

Following data can be stored: title, version, data, description and comments.

6.3.3 Customer Data

ACCESS

Menu: Offline + Customer Data
 Shortcut Key: -

FUNCTION

Permits displaying/changing of customer data.

DESCRIPTION

Following data can be stored: company data (company address, city, state, Zip Code, country and home page) and data for contacts (name, function, department, telephone, mobile phone, fax, bip and e-mail).

6.3.4 End User Data

ACCESS

Menu: Offline + End User Data
Shortcut Key: -

FUNCTION

Permits displaying/changing the end user data.

DESCRIPTION

Following data can be stored: company data (company address, city, state, Zip Code, country and home page) and data for contacts (name, function, department, telephone, mobile phone, fax, bip and e-mail).

6.3.5 Drive Data

ACCESS

Menu: Offline + Drive Data
Shortcut Key: -

FUNCTION

Permits displaying/changing of the drive data.

DESCRIPTION

The following data can be stored: address, type, firmware version, rated voltage, rated current, tag, commercial reference and serial number.

Update Button: SuperDrive requests some basic data about the drive, such as type, firmware version, rated voltage, rated current. If no drive is detected at the address, then the fields will be erased automatically and all files related to this address will be deleted.

6.3.6 Motor Data

ACCESS

Menu: Offline + Motor Data

Shortcut Key: -

FUNCTION

It permits displaying/changing the motor data.

DESCRIPTION

The following data can be stored: manufacturer, type, power, rpm, number of poles, rated voltage, rated current and serial number.

6.4 Online

Select Drive Address

Read Parameters (Drive -> PC)

Write Parameters (PC -> Drive)

Monitor Parameters

Monitor Using Keypad

Monitor Parameters using Modem

Acquire Parameter

View Chart

Online Graph

Trace Function

Error Log

Identify Drives

Communication Settings

6.4.1 Select Drive Address

ACCESS

Menu: Online + Select Drive Address

Shortcut Key: -

FUNCTION

Selects one of the drive configured in the project.

DESCRIPTION

The configured drive is indicated by the check mark at the left of the selected menu item.

6.4.2 Read Parameters (Drive -> PC)

ACCESS

Menu: Online + Read Parameters (Drive -> PC)
 Shortcut Key: -

FUNCTION

Transfers the content of each drive parameter to the microcomputer.

DESCRIPTION

Also known as download, the user can visualize the advance of the parameter reading. Errors that occurred during the reading will be displayed and the end of the reading.

6.4.3 Write Parameters (PC -> Drive)

ACCESS

Menu: Online + Write Parameters (PC -> Drive)
 Shortcut Key: -

FUNCTION

Transfer the content of each parameter stored on the PC (Source Drive) to the Destination Drive. The file XX.par with the parameter contents is required, otherwise an error message will be displayed.

DESCRIPTION

Known as upload, the user can visualize the advance of the parameter writing. Errors that occurred during the writing will be displayed and the end of the writing process. The user shall select the destination address. Model, firmware version, and tag of the source drive are automatically presented.

It will be necessary to confirm if SuperDrive must change the configuration of the destination drive on the project when transferring parameters to a drive with a different address from the source drive. The information of the connected drive will be stored on the project. However, in case there is already a drive configured in that address, the configurations of the connected drive will substitute the configurations of the drive that was previous stored on the project.



NOTE!

It is recommended to write the parameters to drives of the same model and firmware version.

Example:

Source: Address 02, CFW-09 model, firmware version V4.00
 Destination: Address 12, CFW-09 model, firmware version V4.00

It is possible to write parameters to different firmware versions in case the drive is from the CFW-09 series.

In order to do that it is necessary to update the parameters to the version of the destination drive. Currently, the following versions have the automatic updating function: v2.4x, v2.6x, v3.1x, v3.7x and v4.0x. Any update between these versions can be automatically performed. Versions that were not mentioned above can be manually updated by using this tool.

6.4.4 Monitor Parameters

ACCESS

Menu: Online + Monitor Parameters
Shortcut Key: -

FUNCTION

It permits online editing of all drive parameters contents.

DESCRIPTION

The online editing consists in showing/changing all parameter contents. The parameters are showed sequentially on a grid in ascending order. There are two arrows for scrolling down/up. The grid comprises columns containing a note, the parameter number, function range, factory setting, user's setting, unit and comparison. The only field that can be changed in the grid is the user's setting.

Visualization

The user's field is updated automatically.

Changing

The user must click on the user's setting field and fill in the field the desired value. Then he must active Enter and click on OK.

Commands

Show/Hide - This command shows or hides the secondary parameter lines on the grid.

Ok - when this command is give, you exit the window.

Help - this command opens a Help window.

6.4.5 Monitor Using Keypad

ACCESS

Menu: Online + Monitor Using Keypad
Shortcut Key: -

FUNCTION

This function allows to show/change the drive parameter in a similar way as the drive keypad.

DESCRIPTION

CFW and MVW Line

The keypad (HMI) is a simple interface that allows the inverter operation/programming. This interface allows permits following functions:

- indication of the operation status, as well as the display of the main variables.
- fault display.
- visualization and changing of the settable parameters.
- operation: enable, disable, reversal, jog, commutation: local/remote, incrementing/decrementing the parameter number, general enable, general disable, serial reference.
- virtual keypad - local: the key Enable allows that all commands can be executed via serial interface in local status, the key Disable allows that all commands can be executed via serial interface (HMI) in local status.
- virtual key - remote: the key Enable allows that all commands can be executed via serial interface in remote status, the key Disable allows that all commands can be executed via serial interface (HMI) in remote status.

Line SSW

The keypad (HMI) is a simple interface that allows the soft-starter operation/programming. This interface allows permits following functions:

- indication of the operation status, as well as the display of the main variables.
- fault display.
- visualization and changing of the settable parameters.
- operation: enable, disable, reversal, jog, incrementing/decrementing the parameter number, general enable, general disable.
- Motor status: acceleration. Current limiting, rated voltage, energy saving, deceleration, braking, reversal and power supply.

Line SCA

The keypad (HMI) is a simple interface that allows the servodrive operation/programming. This interface allows permits following functions:

- indication of the operation status, as well as the display of the main variables.
- fault display.
- display and change of the settable parameters.
- Operation: enable, speed reference, current reference or position reference, STOP function, among others.

6.4.6 Monitor Parameters using Modem

ACCESS

Menu: Online + Monitor Parameters using Modem
Shortcut Key: -

FUNCTION

Its allow you to monitor the parameters using a telephone line.

DESCRIPTION

It is possible to remotely monitor a drive by using the phone line. In one side we have SuperDrive connected to a modem (internal or external). On the other side of the phone line we have another modem with auto-answer feature, which is connected to a drive. SuperDrive dials the modem with auto-answer feature, the modems establish the communication with each other, and then it is possible to monitor the drive. Figure below illustrates the application.

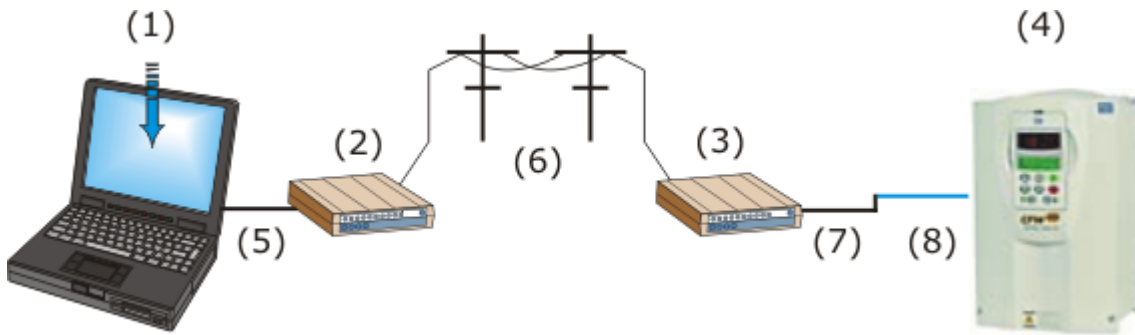

- (1) PC with SuperDrive Software.
- (2) Internal or external Modem.
- (3) External modem with auto-answer feature.
- (4) Drive.
- (5) Direct Modem cable (pin-to-pin) when modem is external.
- (6) Telephone Line.
- (7) Modem Null Cable (crossover cable).
- (8) RS232 PC/Drive serial cable (SuperDrive standard cable).

Direct Modem Cable (pin-to-pin) when using external modem.

This pin-to-pin cable is used to connect the microcomputer to the modem and perform the dialing. This pin-to-pin characteristic means that the same signal from one cable end must be connected to the other cable end.

Example 1: in case of using a cable with two DB9 connectors, pin 1 of the connector will be connected to the pin 1 of the other connector, pin 2 connected to pin 2, and so on.

Example 2: when a DB25 connector cable is connected to a DB9 connector, the pin 8 of the connector DB25 must be connected to the pin 1 of the DB9 connector, and pin 3 of the connector DB25 must be connected to pin 2 of the connector DB9 and so forth.

Table below shows the pin location of this cable.

Signal name	Modem		PC		Signal name
	DB25	DB9	DB9	DB25	
CD (Carrier Detect)	8	1	1	8	CD
RD (Receive Data)	3	2	2	3	RD
TD (Transmit Data)	2	3	3	2	TD
DTR (Data Terminal Ready)	20	4	4	20	DTR
SG (Signal Ground)	7	5	5	7	SG
DSR (Data Set Ready)	6	6	6	6	DSR
RTS (Request To Send)	4	7	7	4	RTS
CTS (Clear To Send)	5	8	8	5	CTS
RI (Ring Indicator)	22	9	9	22	RI
FG (Frame Ground)	1	-	-	1	FG

Drive/PC RS232 serial cable (SuperDrive Standard Cable)

Drive/PC RS232 serial Cable is the standard cable.

Null Modem Cable (Crossover Cable)

The cable used to connect the modem to the SuperDrive standard cable is named as null modem or crossover cable.

The Null Modem cable allows two DTE RS232 devices to communicate with each other. In order to do that, the TD signal from one device shall be connected to the RD input of the other device (and vice versa).

The following table indicates the pins connection when using a null modem cable.

Signal name	Connector Side A		Connector Side B		
	DB25	DB9	DB9	DB25	Signal name
FG (Frame Ground)	1	-	-	1	FG
TD (Transmit Data)	2	3	2	3	RD
RD (Receive Data)	3	2	3	2	TD
RTS (Request To Send)	4	7	8	5	CTS
CTS (Clear To Send)	5	8	7	4	RTS
SG (Signal Ground)	7	5	5	7	SG
DSR (Data Set Ready)	6	6	4	20	DTR
CD (Carrier Detect)	8	1	4	20	DTR
DTR (Data Terminal Ready)	20	4	1	8	CD
DTR (Data Terminal Ready)	20	4	6	6	DSR

For this application only signals RD, TD and GND are used..

RS232 SuperDrive Modem Serial Cable (Unique Cable)

It is also possible to use an only cable to connect the modem to the drive. This cable replaces the modem null cable + SuperDrive standard cable.

In general the RS232 serial port of the modem is DB9 female or DB25 female.

Figure below shows the cable parts for point-to-point RS232 connection. Only pins 2, 3 and 5 of the DB9 female connector are used.

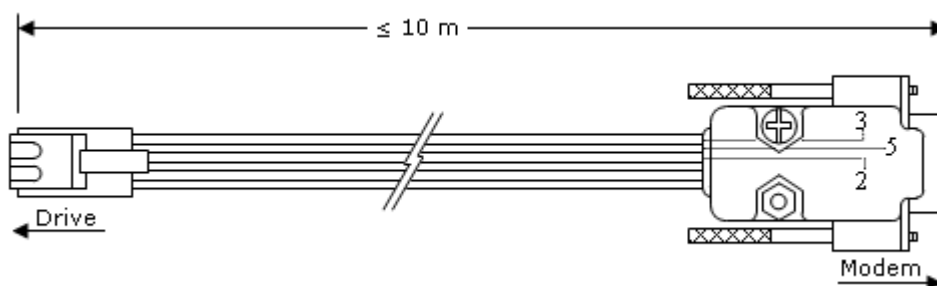

Length: 3 meters.

Maximum cable length: 10 meters.

Table below shows the cable pin location. You can use DB25 male connector or DB9 male connector.

Signal name	Drive		Modem	
	RJ11	DB25	DB9	DB9
TD (Transmit Data)	6	2	3	
RD (Receive Data)	4	3	2	
SG (Signal Ground)	5	7	5	

Only the signal RD, TD and GND are used.

Connector Pinout

The following figures show the pinout of various connectors and aim to help on cable verification.

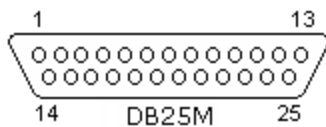
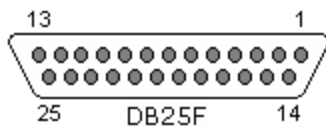
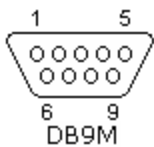
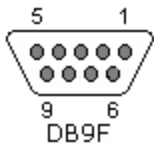

Using SuperDrive with Modem

1. Start SuperDrive.
2. Create project, by clicking [Project > New].
3. Identify connected Drive, clicking [Online > Identify Drives].
4. Click [No] for the message "Drive connected?".
5. Follow the menu and manually select the address, drive model, and firmware version. It is not necessary to indicate the rated voltage and current. It is important to adjust on menu the same firmware version of the drive. If you do not find the correct option, please, contact WEG. SuperDrive will not properly work if you choose a version that is different of the drive version.
6. Click on INSERT in order to add the drive.
7. Click on FINISH when there is no more drives to add.
8. Click on [Online > Communication Setup] and select:
 - Serial Port where the modem is connected to.
 - Number of trials to retransmit a telegram through serial port after an error is detected. Standard is 5 telegrams.
 - Waiting time to receive a telegram. Standard is 100 ms.

- Modem delay time. Standard is 5000 ms.

9. Click on [Online > Monitor Parameters using a Modem].

10. Under Modem window specify:

- Modem command for dialing, the suggested standard is ATDT.
- Phone Number (when using an extension line, add a comma in order to insert an one-second pause).
- Example 1: Phone number 0,33724000. It is a local call.
- Example 2: Phone number 0,0XX4733724000. It is a long distance call, where XX is the phone company code and the area code is 47.

11. Click on [Dial] and wait for the CD signal (green color).

12. After the phone call is established, click on [Start monitoring].

13. SuperDrive is now monitoring the drive through the phone line.

For more details, see online help, accessing [Help > Topics].

Suggestions for Modems

ATMC - Automação e Comunicação Ltda.

<http://www.atmc.com.br>
Model MV34.

To display the commands, use the commands ATE1.

E1 = Eco enabled, ecoa commands to the computer to display what is entered via keypad.

To operate the auto-answer, the manufacturer suggests to apply following commands:

"AT&F&D0&T5X3&K0S2=128S0=2".

AT informs the modem that an AT command is coming.

&F loads factory setting.

&D0 ignores DTR signal.

&T5 disables the remote digital loop recognition.

&X3 enables dialing without tone recognition.

&K0 disables the local flow control.

&S2=128 ignores escape sequence.

&S0=2 answers after 2nd ringing (auto answer).

The user must save the configuration in NVRAM by using "AT&W&W1".

&W saves active profile in profile 0.

&W1 saves active profile in profile 1.

To display what has being saved, enter "AT&V".

&V shows the current configuration and the saved profile.

To implement these commands correctly, check the modem manual or contact the ATMC Technical Support.

Jumpers of the Modem MV34:

S1 = 2-3

S2 = -

S3 = 2-3

Encore Electronics Inc.

<http://www.encore-usa.com/product.php?id=30>
Model ENF656-EV-CIPR external modem.

To display the commands, use the commands ATE1.

E1 = Eco enabled, ecoa commands to the computer to display what is entered via keypad.

To operate the auto-answer, the manufacturer suggests to apply following commands:

"AT&F&D0X3&K0S2=128S0=2".

AT informs the modem that an AT command is coming.
 &F loads factory setting.
 &D0 ignores DTR signal.
 &X3 enables dialing without tone recognition.
 &K0 disables the local flow control.
 &S2=128 ignores escape sequence.
 &S0=2 answers after 2nd ringing (auto answer).

The user must save the configuration in NVRAM by using "AT&W&W1".

&W saves active profile in profile 0.
 &W1 saves active profile in profile 1.

To display what has being saved, enter "AT&V".

&V shows the current configuration and the saved profile.

To implement these commands correctly, check the modem manual or contact the ATMC Technical Support.

How to install a standard modem on Windows

- Go to the Start Menu/ Configuration / Control Panel -> Modem and telephone options -> Modems.
- Press the button Add.
- Select: "Do not detect the modem. It will be selected from a list" and press Next.
- Select "(standard Modem types)" and "33600 bps standard Modem" and press Next. Obs.: in the model section the model must be selected according to modem manufacturer specification.
- Select the serial port where the modem will be connected and press Next. Obs.: This information will be necessary to configure the serial communication of the SuperDrive when on the Online menu the Monitoring using modem option is used.
- Press Finish.
- The modem has been created and it appears on the Modem and telephone Options
- It is possible to visualize the properties of the modem by clicking on the Properties button.

6.4.7 Acquire Parameter

ACCESS

Menu: Online + Acquire Parameter
 Shortcut Key: -

FUNCTION

It allows to acquire up to 4 parameters at the same time.

DESCRIPTION

File Name: file name where the acquired points will be saved.
 Example: P9 (full path will be showed on the window)

Drive Address: drive address in the network (01...30).

Parameters Number: number of parameters that will be monitored (01...04).

Parameters: number of each parameter which will be acquired.

Time between points: time between acquisitions.

Milliseconds: range from 200...65535 ms
 Seconds: range from 1...65 s
 Hour:Minute:Second: range from 00:00:01...23:59:59

Number of Points: number of points to be acquired (read) from drive (1...2000000000)

Trigger Mode: there are 2 modes: manual or event.

In manual mode the user must press the Start button to start the acquisition

In event mode the acquisition is fired after the user has pressed the trigger button and the selected event has been fired.

Available Events

Inverter is enabled (RUN): the acquisition is started, after inverter has been enabled.

Inverter is READY to be enabled: the acquisition is started, when inverter is ready to be enabled.

Power supply voltage is too low for the inverter operation (Undervoltage): when the power supply voltage is too low for the inverter operation, the acquisition is started.

P012 - DI1 = 0: when DI1 is inactive, the acquisition is started.

P012 - DI1 = 1: when DI1 is active, the acquisition is started.

P012 - DI2 = 0: when DI2 is inactive, the acquisition is started.

P012 - DI2 = 1: when DI2 is active, the acquisition is started.

P012 - DI3 = 0: when DI3 is inactive, the acquisition is started.

P012 - DI3 = 1: when DI3 is active, the acquisition is started.

P012 - DI4 = 0: when DI4 is inactive, the acquisition is started.

P012 - DI4 = 1: when DI4 is active, the acquisition is started.

P012 - DI5 = 0: when DI5 is inactive, the acquisition is started.

P012 - DI5 = 1: when DI5 is active, the acquisition is started.

P012 - DI6 = 0: when DI6 is inactive, the acquisition is started.

P012 - DI6 = 1: when DI6 is active, the acquisition is started.

P012 - DI7 = 0: when DI7 is inactive, the acquisition is started.

P012 - DI7 = 1: when DI7 is active, the acquisition is started.

P012 - DI8 = 0: when DI8 is inactive, the acquisition is started.

P012 - DI8 = 1: when DI8 is active, the acquisition is started.

P012 - DI9 = 0: when DI9 is inactive, the acquisition is started.

P012 - DI9 = 1: when DI9 is active, the acquisition is started.

P012 - DI10 = 0: when DI10 is inactive, the acquisition is started.

P012 - DI10 = 1: when DI10 is active, the acquisition is started.

<PXXX> > Content: when the content of the indicated parameter is greater than the selected one, the acquisition is started.

<PXXX> < Content: when the content of the indicated parameter is less than the selected one, the acquisition is started.

<PXXX> = Content: when the content of the indicated parameter is equal to the selected one, the acquisition is started.

<PXXX> >= Content: when the content of the indicated parameter is greater then or equal to the selected one, the acquisition is started.

<PXXX> <= Content: when the content of the indicated parameter is less than or equal to the selected one, the acquisition is started.

Parameter/Content: these fields are enabled only when one of the below events are selected.

<PXXX> > Content

<PXXX> < Content

<PXXX> = Content

<PXXX> >= Content

<PXXX> <= Content

Start Data Acquisition Button: this command is used to start parameter acquisition when set to Manual Mode.

Trigger Button: this command is used to trigger SuperDrive, i. e., SuperDrive monitors the selected event until it occurs.

Erase Fields Button: it loads the standard values in the fields.

Ok Button: to exit the window.

Delay in the parameter acquisition with SuperDrive

There is always a delay between the parameter acquisition and the sampling time. If the sampling rate is set to a value greater than 1 second, the delay in the parameter acquisition is almost imperceptible.

Causes of delay:

- Computer operational system is slow; too many programs running at the same time; number of parameters and samples being acquired.
- The timer that controls the sampling rate restarts the count when the processing routine ends; therefore, all above delays are added to the acquisition time.

6.4.8 View Chart

ACCESS

Menu: Online + View Chart

Shortcut Key: -

FUNCTION

It permits to view the chart with up to 4 parameter that were acquired (Acquire Parameter function).

DESCRIPTION

User must select the name of the chart file (.cht extension).

The chart is displayed in the window and it also indicates some information about the chart.

This information is the same that has been entered by the user in the window Acquire Parameter, besides

the start data, start hour, end data and end hour.

The following information will be available:

- the scale of each parameter can be changed in the range from 1...32767.
- function of each parameter.
- chart type selection: bar 3D, bar 2D, line 3D, line 2D, area 3D, area 2D, step 3D, step 2D.
- the user can enable/disable the grid , the marker or the line.
- printing of the chart with all information contained in the window.
- export graph data to Microsoft Excel.
- definition of the number of visible points displayed on the graph (25 ... 2500).

6.4.9 Online Graph

ACCESS

Menu: Online + Online Graph

Shortcut Key: -

FUNCTION

This function allows monitoring (acquiring) up to 4 signals (parameters/variables) and visualizing these signals in a graph simultaneously.

DESCRIPTION

Signal Selection

The user shall select the channels combo boxes to be used for the data acquisition, the drive address and the signal (parameter/variable) to be monitored on the correspondent lists. By choosing the drive address, the drive model and the firmware version will be displayed, and the available signals will be loaded into the variables list. By choosing the variable, the description and the minimum and maximum scale values will be automatically loaded.

Setting the time between samples

The time between samples can be set on the time between samples textbox. This is the time interval between two consecutive signal samples.

Setting the time scale

Choose a horizontal scale for the graph from the list. This is the time interval presented on the graph.

Starting and stopping the acquisition

The data acquisition can be started or stopped by pressing the Start/Stop button in the toolbar or by selecting the correspondent item under the Acquisition menu.

Pausing graph updating

It is possible to stop the graph updating without interrupting the signal acquisition by pressing the Pause button or through the item Pause updating under the Graph menu.

Displaying the channel line

It is possible to choose the channels to be shown on the graph by clicking on the channel check box below the horizontal axis scale. The other channels will be also acquired, however they will not be displayed on the graph.

Signal Value

The current signal value can be seen in the signal amplitude field. In the Cursor mode, when you click in any point of the graph, the signal value in that point is displayed.

Signal Scale

The signal scale can be changed by using the Max and Min textboxes.

Changing the thickness and the color of the graph line

The thickness and the color of the graph line for each signal can be changed.

Click on the signal color (near the combo box) to change it. P.S.: this operation can be performed only when the acquisition is stopped.

Select one item from the list of line thicknesses (near the signal value) to change the line thickness.

Changing the graph background color

Select the item Background Color under the submenu Color under the Graph menu to change the graph background color.

Recorder

There is an option for recording the data during the acquisition. After configuring the acquisition, press the Record button or select the correspondent item under the Recorder menu. Start the acquisition. The data will be saved in a file and the number of recorded points is presented in the status bar. Stop the acquisition and save the file by using the option Save as of the Recorder menu.

Opening a file with stored data

Select the item Open under the Graph menu and search for the file you want to display. It is possible to navigate through the data by using the navigation bar below the graph.

Zoom

Press the Zoom button or choose the correspondent item on the Graph menu to activate the Zoom function. Click on the graph and drag to select the portion of the graph you want to apply the zoom. The selected area will be expanded to fit in the whole graph area.

Cursor mode

Click on the Cursor button or select the correspondent item under the Graph menu to activate the cursor mode. In this mode, when you click in any point of the graph, the time for that point is presented in the graph top and the signal values are presented in the signal amplitude textbox.

P.S.: In this mode the zoom cannot be changed.

Export

It is possible to export the acquisition file data to the Microsoft Excel format. Select the item Export under the Graph menu to export the data.

Copy the graph

Select the item Copy to clipboard under the Graph menu to copy the graph to the clipboard. If the option Use white background when printing or copying under the submenu Color is selected, then the graph will be copied with a white background instead of the colors that appear on the screen.

Print

Select the Print item under Graph menu to print the current graph screen with the channel data, starting acquisition date, time scale and time between samples. If the option Use white background when printing or copying under the submenu Color is selected, then the graph will be printed with a white background instead of the colors that appear on the screen.

Clear the graph screen

Select the item Clear under Graph menu to clear the graph screen.

Markers

Select the item Markers under Graph menu to present the markers that identifies each graph channel.

6.4.10 Trace Function

ACCESS

Menu: Online + Trace Function

Shortcut Key: -

FUNCTION

This function allows configuring the trace function and downloading the data stored on the drive's trace memory (these data can be displayed in a graph). This function is available only for the MVW-01 drive.

DESCRIPTION

SETTINGS

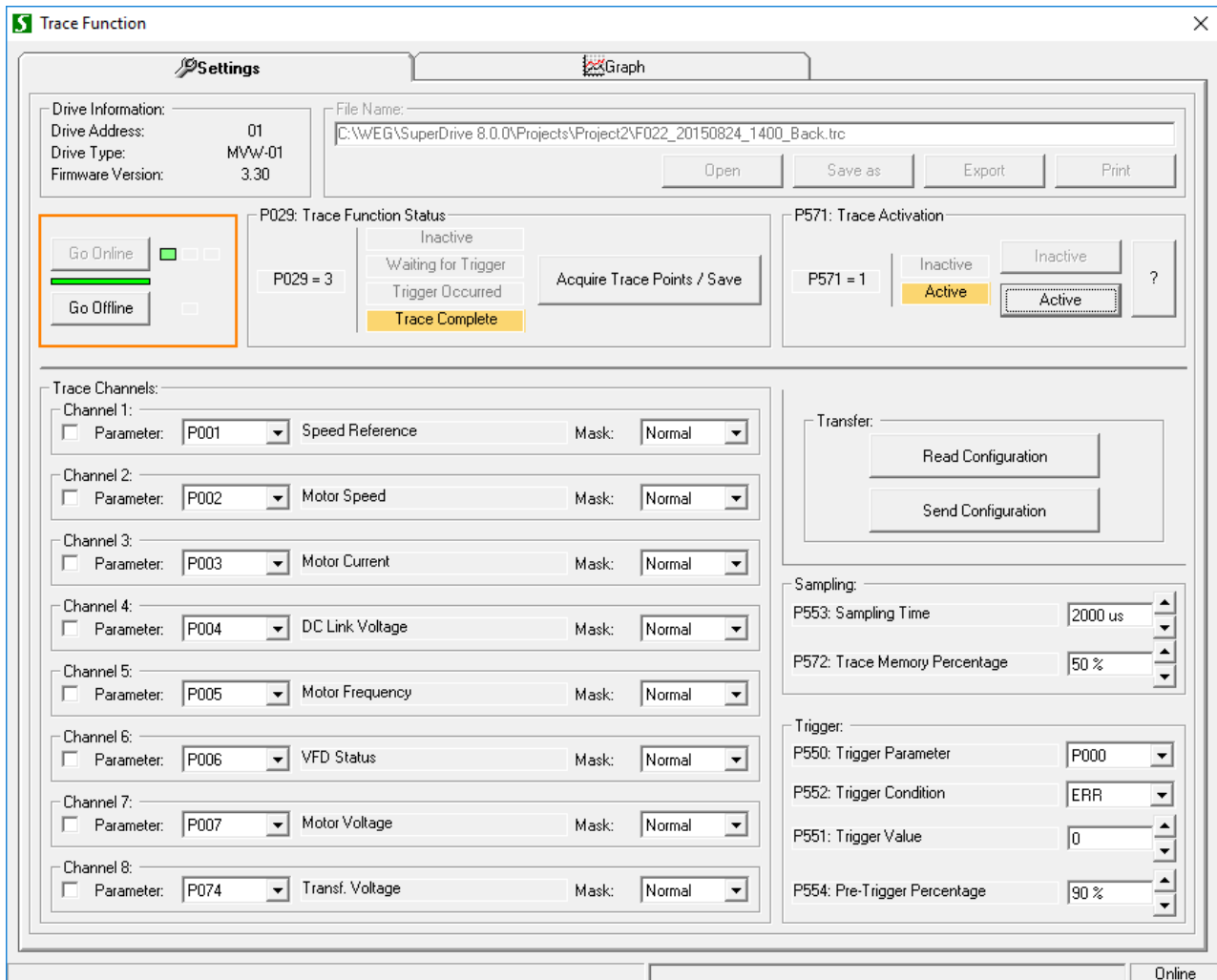

Reading Configurations

Click on the Read Configuration button to read the drive configuration. The parameters configuration of the drive's trace function will be updated on the screen.

Writing Configurations

The trace configurations will be sent to the drive when the Send Configuration button is pressed, however, the trace will not be activated.

Important: It is only possible to change the configuration if the data acquisition is inactive.

Channels

The channels from 1 to 8 can be configured by using the lists. The mask list is available only for parameters P012 and P013.

Sample Time

The sample time shall be a multiple value of 500 microseconds.

Trigger Value

The trigger value shall be configured with the internal representation of the processor so that the trace function works properly.

Example: If P550 = 4, set P551 = 4095 to compare the value of P004 with the total DC Link voltage value (100%). The parameter P004 uses the numerical format Q4.12.

Data Acquisition

- The trace function is deactivated by pressing the Inactive button. P.S.: When the Inactive button is pressed, the previous data stored on the drive is erased.
- The trace configuration and the command to activate the trace function will be sent to the drive when the Active button is pressed.

Acquiring the Trace Channels Data

The button Acquire trace points and the channel combo boxes will be enabled if the trace status is Trace complete.

In order to acquire the trace channel data, first selected the desired channels, then change the filename where the data should be saved (click on Change to change the filename) and finally press the Acquire trace points button.

It is possible to read data from other channels in different moments and save them in the same file.

Press the Save as button to save the file with a different name. P.S.: the destination filename shall be different from the source filename to avoid data lost.

Export

It is possible to export the acquisition file data to the Microsoft Excel by pressing the Export button.

GRAPH

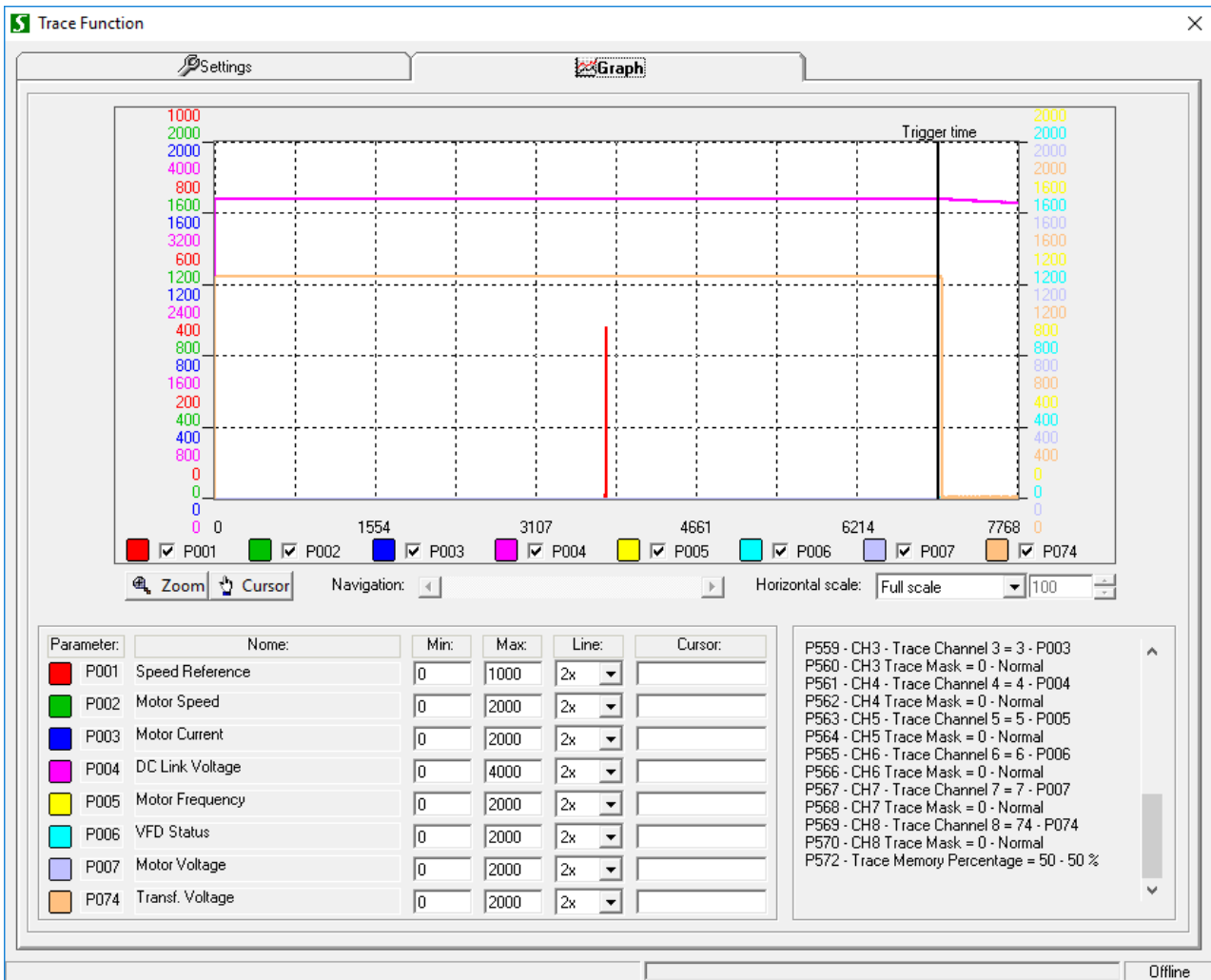

The trace information recorded in the file is presented in the window.

The SuperDrive indicates:

- filename;
- address, model, drive firmware version;
- date and time of trigger;
- number of points per channel;
- trigger position;
- parameters of the trace function.

Visualizing Channels in the Graph

It is possible to choose the channels to be displayed on the graph by clicking on the channel combo boxes below the horizontal axis scale.

The parameters set in the trace channels are displayed below, where the user can change the scale of each channel by using the Max and Min textboxes, the line thickness and color for each channel, and see the parameter value for the channel in the point where the cursor is located (when the Cursor mode is active).

Horizontal Axis Scale

The horizontal axis scale can be changed by selecting one of the available options. The Personalized option allows the user to select a different scale for the graph.

Opening a File with Stored Data

Click on the Open button under the Settings tab and search for the file you want to display. It is possible to navigate through the data by using the navigation bar below the graph.

Zoom

Press the Zoom button to activate this function. Click on the graph and drag to select the portion of the graph you want to apply the zoom. The selected area will be expanded to fit in the whole graph area.

Cursor Mode

Click on the Cursor button to activate the cursor mode. In this mode, when you click in any graph point, the selected point is presented in the bottom part of the graph. The signal values are presented in the Cursor textbox.

P.S.: In this mode the zoom cannot be changed.

Print

Press the Print button under the Settings tab to print the current graph screen with the channels data, trigger date, number of points per channel, and the trigger position.

6.4.11 Error Log

ACCESS

Menu: Online + Error Log

Shortcut Key: -

FUNCTION

This function allows visualizing the last 100 drive errors. Available only for the MVW-01 drive.

DESCRIPTION

With this function, it is possible to retrieve the last 100 errors stored on the drive and see them in a list.

In order to retrieve the errors press the Read Errors button. When the acquisition of the errors is complete, the data stored on the drive will be presented in a list. These data can be saved to a file by pressing the Save button.

In order to erase the data for the last errors in the screen press the clear button.

The options for exporting the data to Microsoft Excel and printing the errors list are available.

6.4.12 Identify Drives

ACCESS

Menu: Online + Identify Drives

Shortcut Key: -

FUNCTION

Identifies the drives that are RS232 network or via RS 484 connected. I.e. which drives can communicate with the SuperDrive.

DESCRIPTION

It is possible to identify the drives automatically or selecting them manually. SuperDrive reads up to 30 drives that are RS485 network connected.

Automatic Detection

SuperDrive identifies automatically the drives that are network: at the end of the operation, the network window shows the drives their characteristics.

Manual Selection

The manual selection is used when no drive is connected to the SuperDrive and is used only to create and offline configuration.

The user can insert 1 drive in RS232 and up to 30 drives in RS485.

For each drive you must define at minimum the address, type and firmware version. The definition of the rated voltage, rated current and tag are optional.

The drives have the following characteristics:

CFW-05, CFW-07, CFW-09, SSW-03, SSW-04, MVW-01:
Address, type, firmware version, rated voltage, rated current.

CFW-08, SCA-04, SCA-05, SSW-05:
Address, type, firmware version, rated current, rated current. (there is no rated voltage).

In manual selection, the firmware version defined by the user must be the same as that in the drive that will be connected to the PC.

6.4.13 Communication Settings

ACCESS

Menu: Online + Communication Settings

Shortcut Key: -

FUNCTION

Configures Serial Port.

DESCRIPTION

Serial number of the port: 1...16 (COM1...COM16). It is the number of COM that will realize the communication between drive and SuperDrive.

Number of trials to transmit a telegram through serial port when an error is found: 1...10. This is the number of trials to send a telegram when the drive is not answering, i. e., the SuperDrive will send the telegram how often the number of trials will be.

Time-out to receive a telegram (ms): it is the time that SuperDrive waits to consider an error.

Modem delay time-out (ms): extra time considered during the serial communication when a modem is used.

It tests the drive type and the firmware version before the telegram is sent via serial port: enabled or not. SuperDrive checks if the connected drive is of the same type and firmware version of the project before it starts the serial communication.



NOTE!

No other application can use this serial port simultaneously with the SuperDrive.

6.5 Macros

Basic Application

Always Local Command

Always Remote Command

Multispeed with Commands via Digital Inputs

Local/Remote Command with Selection via HMI

Local Command with Reference via HMI and 3-Wire Start/Stop

6.5.1 Basic Application

ACCESS

Menu: Macros + Basic Application

Shortcut Key: -

FUNCTION

It allows defining the macro for the CFW-09 drive.

The macro parameters may be saved in file. The macro can also be printed.

DESCRIPTION

This application should be used immediately after the routine of the first start-up has been concluded (loads factory standard parameters) where the drive and the motor data have been defined, including the type of control. The user defines the max./min. motor speed reference. The user also defines the acceleration time required for accelerating from the min. frequency up to the max. frequency and the deceleration time required for decelerating from the max. frequency up to the min. frequency.

Drive Data

The user can see the drive data. However these parameters can not be changed in this window, they can be displayed only.

These parameters can be changed only by using the offline parameter editor.

Drive Model - CFW-09
 P023 - Firmware Version
 P296 - Rated Voltage
 P295 - Rated Current

Motor Data

The user can see the motor data. However these parameters can not be changed in this window, they can be displayed only.

These parameters can be changed only by using the offline parameter editor.

P400 - Motor Rated Voltage
 P401 - Motor Rated Current
 P402 - Motor Rated RPM
 P403 - Motor Rated Frequency
 P404 - Motor Rated HP

P405 - Encoder PPR
P406 - Motor Ventilation Type

Basic Application Parameters

The user must define the basic application parameters, which are P100, P101, P133 e P134.

P100 - Acceleration Time
P101 - Deceleration Time
P133 - Minimum Speed Reference
P134 - Maximum Speed Reference

File Name - file name to save the macro.

Save - saves the macro in file.

Search - it allows selecting a macro file.

Print - it prints the macro.

Send - it sends the macro to the drive.

Read the Project - it reads each parameter stored in the project and loads them in the suitable field.

Read the Drive - it reads each parameter from the drive and loads them in the suitable field. The read parameters are not stored in the project. They are only displayed.

6.5.2 Always Local Command

ACCESS

Menu: Macros + Always Local Command

Shortcut Key: -

FUNCTION

It allows defining the macro for the CFW-09 drive.

The macro parameters can be saved in file. The macro can also be printed.

DESCRIPTION

User can command the drive from an only command origin which commands for speed reference, run/stop and direction of rotation should be defined previously

The user can visualize the function of each pin of the XC1/XC1A terminal according to the selections. Next each selected item you can see the content of each parameter which will be sent to the drive when the macro will be sent.

When Multipeed will be selected in the Speed Reference , the user must fill-in the value of P124 ... P131.

Selections

Options for the Speed Reference:

- Analog Signal from 0 to 10 Vcc - AI1
- Analog Signal from 0 to 10 Vcc - AI2
- Analog Signal from 0 to 20 mA - AI1
- Analog Signal from 0 to 20 mA - AI2
- Analog Signal from 4 to 20 mA - AI1
- Analog Signal from 4 to 20 mA - AI2
- Potentiometer 5 kOhms 1 or 10 turns - AI1
- Potentiometer 5 kOhms 1 or 10 turns - AI2
- Electronic Potentiometer - DI3/DI4
- Electronic Potentiometer - DI5/DI6

- Multispeed
- Via HMI keypad
- Via serial

Options for Run/Stop Commands:

- Via digital input with ramp enable
- Via digital input with general enable - DI1
- Via digital input with general enable - DI3
- Via digital input with general enable - DI4
- Via digital input with general enable - DI5
- Via digital input with general enable - DI6
- Via digital input with ramp and general enable - Disable by Ramp DI1 - General Enable DI3
- Via digital input with ramp and general enable - Disable by Ramp DI1 - General Enable DI4
- Via digital input with ramp and general enable - Disable by Ramp DI1 - General Enable DI5
- Via digital input with ramp and general enable - Disable by Ramp DI1 - General Enable DI6
- Via HMI Keypad
- Via serial

Options for Direction of Rotation:

- Only one Direction of rotation - CW
- Only one Direction of rotation - CCW
- CW/CCW via digital input
- Via HMI Keypad - CW
- Via HMI Keypad - CCW
- Via serial - CW
- Via serial - CCW

File Name - file name to save the macro.

Save - saves the macro in file.

Search - it allows selecting a macro file.

Print - it prints the macro.

Send - it sends the macro to the drive.

Read the Project - it reads each parameter stored in the project and loads them in the suitable field.

Read the Drive - it reads each parameter from the drive and loads them in the suitable field. The read parameters are not stored in the project. They are only displayed.

See orientative diagram - a new window is opened, where the diagram is orientative and corresponds to a standard factory configuration. It does not correspond to the user selected configuration.

6.5.3 Always Remote Command

ACCESS

Menu: Macros + Always Remote Command

Shortcut Key: -

FUNCTION

It allows defining the macro for the CFW-09 drive.

The macro parameters can be saved in file. The macro can also be printed.

DESCRIPTION

User can command the drive from an only command origin which commands for speed reference, run/stop and direction of rotation should be defined previously

The user can visualize the function of each pin of the XC1/XC1A terminal according to the selections. Next

each selected item you can see the content of each parameter which will be sent to the drive when the macro will be sent.

When Multipeed will be selected in the Speed Reference , the user must fill-in the value of P124 ... P131.

Selections

Options for the Speed Reference:

- Analog Signal from 0 to 10 Vcc - AI1
- Analog Signal from 0 to 10 Vcc - AI2
- Analog Signal from 0 to 20 mA - AI1
- Analog Signal from 0 to 20 mA - AI2
- Analog Signal from 4 to 20 mA - AI1
- Analog Signal from 4 to 20 mA - AI2
- Potentiometer 5 kOhms 1 or 10 turns - AI1
- Potentiometer 5 kOhms 1 or 10 turns - AI2
- Electronic Potentiometer - DI3/DI4
- Electronic Potentiometer - DI5/DI6
- Multispeed
- Via HMI keypad
- Via serial

Options for Run/Stop Commands:

- Via digital input with ramp enable
- Via digital input with general enable - DI1
- Via digital input with general enable - DI3
- Via digital input with general enable - DI4
- Via digital input with general enable - DI5
- Via digital input with general enable - DI6
- Via digital input with ramp and general enable - Disable by Ramp DI1 - General Enable DI3
- Via digital input with ramp and general enable - Disable by Ramp DI1 - General Enable DI4
- Via digital input with ramp and general enable - Disable by Ramp DI1 - General Enable DI5
- Via digital input with ramp and general enable - Disable by Ramp DI1 - General Enable DI6
- Via HMI Keypad
- Via serial

Options for Direction of Rotation:

- Only one Direction of rotation - CW
- Only one Direction of rotation - CCW
- CW/CWW via digital input.
- Via HMI Keypad - CW
- Via HMI Keypad - CCW
- Via serial - CW
- Via serial - CCW

File Name - file name to save the macro.

Save - saves the macro in file.

Search - it allows selecting a macro file.

Print - it prints the macro.

Send - it sends the macro to the drive.

Read the Project - it reads each parameter stored in the project and loads them in the suitable field.

Read the Drive - it reads each parameter from the drive and loads them in the suitable field. The read parameters are not stored in the project. They are only displayed.

See orientative diagram - a new window is opened, where the diagram is orientative and corresponds to a standard factory configuration. It does not correspond to the user selected configuration.

6.5.4 Multispeed with Commands via Digital Inputs

ACCESS

Menu: Macros + Multispeed with Commands via Digital Inputs

Shortcut Key: -

FUNCTION

It allows defining the macro for the CFW-09 drive.

The macro parameters can be saved in file. The macro can also be printed.

DESCRIPTION

The user can operate the drive with up to 8 fixed predefined speed that can be selected via digital inputs.

The user can visualize the function of each pin of the XC1/XC1A terminal according to the selections. Next each selected item you can see the content of each parameter which will be sent to the drive when the macro will be sent. The user must also select the number of speeds and then fill-in the value of each speed P124 ... P131.

Selections

Local/Remote Selection:

- Always local
- Always remote

Direction of Rotation:

- CW
- CWW
- Reversal via DI2

Start/Stop Command via DI:

- Local (displayed when local/remote = always Local has been selected)
- or
- Remote (displayed when local/remote = always Remote has been selected)

Number of Speeds:

- 2 speeds
- P124 - Reference 1 Multispeed
P125 - Reference 2 Multispeed

or

- 4 speeds
- P124 - Reference 1 Multispeed
P125 - Reference 2 Multispeed
P126 - Reference 3 Multispeed
P127 - Reference 4 Multispeed

or

- 8 speeds
- P124 - Reference 1 Multispeed
P125 - Reference 2 Multispeed
P126 - Reference 3 Multispeed
P127 - Reference 4 Multispeed
P128 - Reference 5 Multispeed

P129 - Reference 6 Multispeed
P130 - Reference 7 Multispeed
P131 - Reference 8 Multispeed

File Name - file name to save the macro.

Save - saves the macro in file.

Search - it allows selecting a macro file.

Print - it prints the macro.

Send - it sends the macro to the drive.

Read the Project - it reads each parameter stored in the project and loads them in the suitable field.

Read the Drive - it reads each parameter from the drive and loads them in the suitable field. The read parameters are not stored in the project. They are only displayed.

See orientative diagram - a new window is opened, where the diagram is orientative and corresponds to a standard factory configuration. It does not correspond to the user selected configuration.

8 speeds			
4 speeds			
2 speeds			
DI6	DI5	DI4	Speed Ref.
0V	0V	0V	P124
0V	0V	24V	P125
0V	24V	0V	P126
0V	24V	24V	P127
24V	0V	0V	P128
24V	0V	24V	P129
24V	24V	0V	P130
24V	24V	24V	P131

Multispeed References

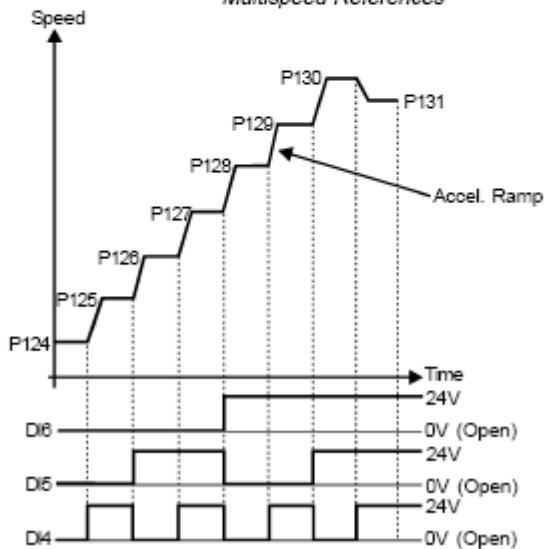

Multispeed

6.5.5 Local/Remote Command with Selection via HMI

ACCESS

Menu: Macros + Local/Remote Command with Selection via HMI

Shortcut Key: -

FUNCTION

It allows defining the macro for the CFW-09 drive.
The macro parameters can be saved in file. The macro can also be printed.

DESCRIPTION

User can command the drive from an only command origin which Local and Remote commands should be defined previously.

The user can visualize the function of each pin of the XC1/XC1A terminal according to the selections. Next each selected item you can see the content of each parameter which will be sent to the drive when the macro will be sent.

Selections

Local Command:

- HMI

Remote Command:

- Terminals

File Name - file name to save the macro.

Save - saves the macro in file.

Search - it allows selecting a file with the macro.

Print - it prints the macro.

Send - it sends the macro to the drive.

See orientative diagram - a new window is opened, where the diagram is orientative and corresponds to a standard factory configuration. It does not correspond to the user selected configuration.

6.5.6 Local Command with Reference via HMI and 3-Wire Start/Stop

ACCESS

Menu: Macros + Local Command with Reference via HMI and 3-Wire Start/Stop

Shortcut Key: -

FUNCTION

It allows defining the macro for the CFW-09 drive.
The macro parameters can be saved in file. The macro can also be printed.

DESCRIPTION

User can command the drive from an only command origin which Speed Reference Commands/ Run/Stop Command and Direction of Rotation Command should be defined previously.

The user can visualize the function of each pin of the XC1/XC1A terminal according to the selections. Next each selected item you can see the content of each parameter which will be sent to the drive when the macro will be sent.

Selections

Speed Reference:

- HMI

Command Run/Stop:

- Terminals

- Direction of rotation
- Terminal

File Name - file name to save the macro.

Save - saves the macro in file.

Search - it allows selecting a macro file.

Print - it prints the macro.

Send - it sends the macro to the drive.

See orientative diagram - a new window is opened, where the diagram is orientative and corresponds to a standard factory configuration. It does not correspond to the selected user configuration.

6.6 Tools

Drives Network

Update parameters to other firmware version

Language

Options

6.6.1 Drives Network

ACCESS

Menu: Tools + Drives network

Shortcut Key: -

FUNCTION

Permits displaying all drives (1...30) that are connected to the SuperDrive or configured only.

DESCRIPTION

Following data can be displayed:

- Address
- Type
- Firmware Version
- Nominal Voltage
- Nominal Current
- Tag

6.6.2 Update Parameters to Other Firmware Version

ACCESS

Menu: Tools + Update parameters to other firmware version

Shortcut Key: -

FUNCTION

This tool was designed for updating CFW-09 parameters from the original firmware version, where the parameters were created, to a different firmware version.

DESCRIPTION

When selecting this tool, the user shall indicate the firmware version to which the parameters of each drive on the network will be converted.

The conversion is performed and the parameters that were changed are presented to the user. The parameters that cannot be automatically updated will be loaded with the factory default value. The user will still be able to change the parameters manually.

The project shall be saved with a different name, so that the existing information is not lost.

Currently, the following versions have the automatic updating function:

- v2.4x
- v2.6x
- v3.1x
- v3.7x
- v4.0x
- v4.4x

Any update between these versions can be automatically performed. Versions that were not listed above can be manually updated by using this tool.

Example:

- The parameters of a CFW-09 v2.42 were read and stored on the PC.
- The drive was replaced by a CFW-09 v2.64.
- It is desired to transfer the CFW-09 v2.42 parameters stored on the PC to the new CFW-09 v2.64 drive.
- The group of parameters is different since we have different software versions.
- One example is parameter P404. When it is set to 9 on version 2.42 we have 6.0 HP/4.5 kW; when it is set to 9 on version 2.64 we have 5.5 HP/4.0 kW.
- By using this tool the contents will be converted and it will be possible to transfer them to the drive.

6.6.3 Language

ACCESS

Menu: Tools + Language

Shortcut Key: -

FUNCTION

Selects the message language.

DESCRIPTION

You can select between Portuguese, English or Spanish.

After user confirmation, SuperDrive shows the messages in the selected language.

6.6.4 Options

ACCESS

Menu: Tools + Options

Shortcut Key: -

FUNCTION

Displays the option windows, where the user can configure the SuperDrive.

DESCRIPTION

Sound a tone

When activated, a bip is emitted in various situations, such as when the windows are closed, when a value is inserted in a text input box, when a drive is detected in the automatic network identification, etc.

Confirmation when exiting the program

When activated, a message confirming the exit is presented when the user closes the SuperDrive.

Confirmation message to continue

When activated, a message asks the user to confirm the execution continuation.

This happens with the following functions:

- 1- Close project
- 2- Read from drive
- 3- Write to the drive
- 4 - Identify drives / search for drives automatically

Example:

Before the parameters download is executed (read the drive), the user must confirm this operation.

Background color

This enables user to select a background color, using a dialogue box of standard Windows colors. The user can select between the standard colors or he can create and select a personalized color.

Standard

After user's confirmation all configurations returns to the default values. Also the windows position and size (those that can be changed) will be changed to the default values.

Shows the Warning window during the initialization

When activated, the windows Warning is always displayed during the SuperDrive initialization

Test of the serial port during initialization

When activated, the configured serial port is tested during the SuperDrive initialization.

If any error occurs, the communication setting windows is open and the user can select another serial port (COM1...COM16).

Narrowing Effect during Windows Closing

When activated, the windows is narrowed during closing in so many steps as selected on the slide bar (1...100).

The higher the number selected on the slide bar, the slower will be the closing of the windows, giving a shrinkage effect.

Projects path

Allows the user to select the path where the projects of the SuperDrive must be saved.

6.7 Help

Topics

Technical Support

Safety Warning

License

About SuperDrive

6.7.1 Topics

ACCESS

Menu: Help + Topics

Shortcut Key: -

FUNCTION

Shows the Help Window of the SuperDrive.

DESCRIPTION

The user can select on of the following tables:

Content

The manual is distributed by topics and divided in subjects.

Index

The user analyze the manual by entering a known keyword.

Localize

The user localizes the subject by topics shown in alphabetic order.

6.7.2 Technical Support

ACCESS

Menu: Help + Technical Support

Shortcut Key: -

FUNCTION

Shows a window with information of technical support.

DESCRIPTION

It presents data such as website, telephone and email (if available).

6.7.3 Safety Warning

ACCESS

Menu: Help + Safety Warning
Shortcut Key: -

FUNCTION

Shows a window with safety warning.

DESCRIPTION

Safety warning:

The use of this software can change the operation or the performance of the drive. The user is responsible for the adoption of all necessary precautions to ensure the safety of the equipment and involved personnel. Before this Software is used, read carefully all Instruction of the Online Help. The non observation of these instructions can cause serious damages to the equipment and result in serious personnel injuries.

6.7.4 License

ACCESS

Menu: Help + License
Shortcut Key: -

FUNCTION

It presents a window with the license agreement of SuperDrive.

DESCRIPTION

It presents the license agreement.

The license in PDF format can be found in the Help folder where SuperDrive is installed.

Example: C:\WEG\SuperDrive 8.0.0.3041\Help.

6.7.5 About SuperDrive

ACCESS

Menu: Help + About SuperDrive
Shortcut Key: -

FUNCTION

Displays the window with information about SuperDrive.

DESCRIPTION

This window displays the number of the version, copyrights and system information.

7 Wizards

Contents of this chapter:

A Wizard is a tool which leads a user step-by-step to program drives.

Three wizards tools are available that are automatically activated by SuperDrive.

These wizards tools are activated during serial communication.

Initial Power-up Wizard

Control Setting Wizard

Self-Tuning Wizard

7.1 Initial Power-up Wizard

CFW-09

This wizard will guide the user through sequential steps. Parameters P201, P296, P400, P401, P403, P402, P404, P406 will be programmed in this wizard.

MVW-01

This wizard will guide the user through sequential steps. Parameters P201, P400, P401, P403, P402 will be programmed in this wizard.

7.2 Control Setting Wizard

VECTOR CONTROL

CFW-09

This wizard will guide the user through sequential steps. Parameters P400, P401, P403, P402, P404, P406, P408, P409, P410, P411, P412, P413 will be programmed in this wizard.

MVW-01

This wizard will guide the user through sequential steps. Parameters P400, P401, P402, P403, P404, P405, P406, P408, P409, P410, P411, P412, P413 will be programmed in this wizard.

VVW CONTROL

CFW-09

This wizard will guide the user through sequential steps. Parameters P400, P401, P403, P402, P404, P406, P407, P399, P408, P409 will be programmed in this wizard.

7.3 Self-Tuning Wizard

CFW-09

This wizard will guide the user through sequential steps. Parameters P409, P410, P411, P412, P413 will be estimated automatically by the drive.

8 Serial Communication

Contents of this chapter:

Drive Parametrization

Protocol

RS232

RS485

Adam 4520

IC109A

MIW-02

Serial Communication Errors

USB Serial Converter

8.1 Drive Parametrization

The following parameters must be set as below:

Drive	Connection Type	Parameter	Description	SuperDrive Default
MVW-01	RS232/RS485	308	Drive Address	1
		309	Fieldbus	0 = Disable
		312	Serial Communication Protocol	0 = WEGBUS
CFW-05	RS232/RS485	307	Serial Bit Rate (bit/s)	6 = 9600
CFW-07	RS232/RS485	308	Drive Address	1
		308	Drive Address	1
CFW-08	RS232/RS485	308	Drive Address	1
		312	Serial Communication Protocol	0 = WEGBUS
CFW-09	RS232/RS485	308	Drive Address	1
		309	Fieldbus	0 = Disable
		312	Serial Communication Protocol	0 = WEGBUS
CTW-04	RS232/RS485	65	DI Function (XC1:37)	1 = operation via serial (WEGBUS) or DI
		83	Serial WEGBUS	1 = 9600 bps
		84	Drive Address	1
		85	FieldBus	0 = Inactive
SCA-04	RS232/RS485	55	Drive Address	1
		48	Serial Communication Protocol	0 = 7 bits + 1 parity bit
SCA-05	RS232/RS485	308	Drive Address	1

Drive	Connection Type	Parameter	Description	SuperDrive Default
		310	Serial Bit Rate	1 = 9600 bits/s
		311	Data Bits, Parity, stop bits	7=7bits, even parity, 1 stop bit
		312	Serial Communication Protocol	0 = WEGBUS
SSW-03	RS232/RS485	62	Drive Address	1
SSW-04	RS232/RS485	62	Drive Address	1
SSW-05	RS232/RS485	308	Drive Address	1

NOTE!

Drive and SuperDrive must use the same settings.



For CTW-04 the general blocking DI (XC1:27) must be with 24 V (General enabled) to allow the communication to occur.

For SCA-05 P311 and P312 settings are different from the factory default's. The changes made at these parameters will be valid only after pressing the reset key on the Keypad.

8.2 Protocol

The serial communication protocol is shown below:

Baud Rate	(default) 9600 Bauds (bits/s)
Start Bits	1
Data Bits	7
Parity	Even
Stop Bits	1

8.3 RS232

DESCRIPTION

If running of only one drive is desired, using SuperDrive, and this drive is located at a distance shorter than 10 m from the PC, the connection between the computer and the drive may be performed directly, as shown in figure below.

This connection is made with RS232 PC/Drive serial cable, supplied in the SuperDrive kit.

If the distance between the PC and the drive is longer than 10 m, see RS485 serial Interface.

CONNECTION

Figure below shows how to connect PC and Drive via RS232 (point-to-point).

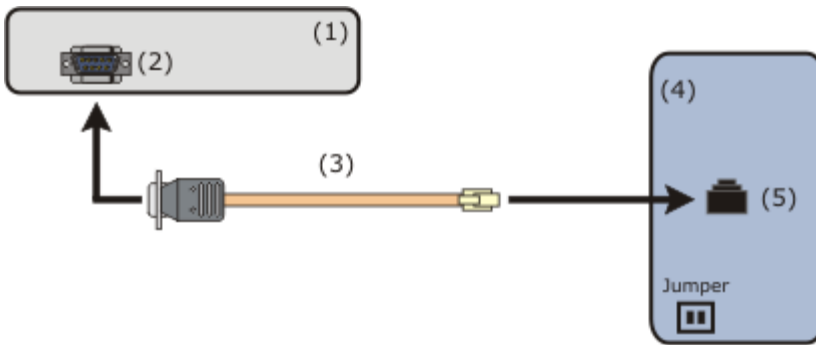

- (1) PC with SuperDrive software.
- (2) DB9 Male connector.
- (3) RS232 serial cable for PC/Drive connection.
- (4) Drive.
- (5) RJ11 connector.

Drive	Board	Connector	Jumper
CFW-05	CEC5/MEC5	XC7	XJ3=1-2
CFW-07	CEC8	XC3	
CFW-08	MCW-01(COS1)	XC8	
CFW-09	RS232 Serial Interface	XC7	
SSW-03	CCS1	XC2	
SSW-04	CCS4	X3	
SSW-05	CCS50, CCS51	Serial Port RS232	
SCA-04	CCA-1	X4	
SCA-05	CCA-5	X4	
CTW-04	CCW4	XC3	
MVW-01	MVC2	XC7	

The DB9 connector should be connected to one on serial ports of the microcomputer. Use one the 16 serial ports (COM1 to COM16), since this information will be requested later by the SuperDrive during operation.

RS232 PC/DRIVE SERIAL CABLE

Figure below shows the cable parts for point-to-point RS232 connection. Only pins 2, 3 and 5 of the DB9 female connector are used.

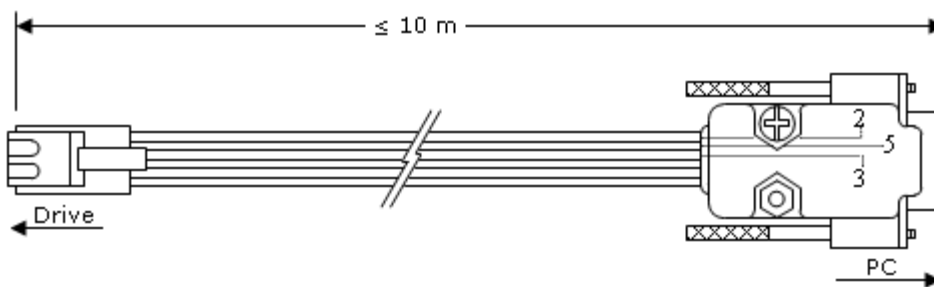

Length: 3 meters.
Maximum cable length: 10 meters.

DB9/DB25 ADAPTER

The RS232 serial cable used for the connection between PC and drive is fitted at one end with a DB9 female connector. The PC connector is a DB9 male connector. If the PC connector is a DB25 male

connector, you must use a DB9/DB25 adapter.

Figure below shows the adapter.

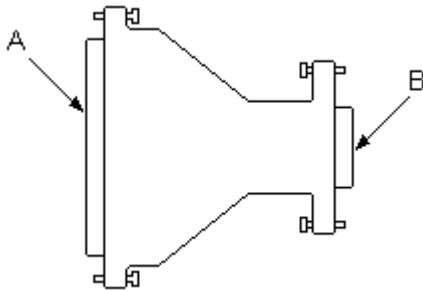

A - DB25 female connector

B - DB9 male connector

Table below shows the connection of the pins of the adapter.

Signal name	DB9	DB25
CD	1	8
RXD	2	3
TXD	3	2
DTR	4	20
GND	5	7
DSR	6	6
RTS	7	4
CTS	8	5
RI	9	22

8.4 RS485

DESCRIPTION

The RS485 serial interface is used when the distance between PC and the drive is longer than 10 meters or when using a network of drives (up to 30 drives). The maximum distance between the PC and the drives is of 1000 meters.

Some drives (CFW-05, CFW-08, CFW-09 and MVW-01) may be connected directly to the RS485 serial interface by using an expansion board (optional board).

Other drives (CFW-07, CFW-08, SSW-03, SSW-04, SSW-05, SCA-04, SCA-05 e CTW-04) require the use of the MIW-02 module.

The use of a RS232 converter is required for the RS485 between the microcomputer and the RS485 network.

CONNECTION

Figure below show how to connect the RS485 serial interface between the PC and the Drives.

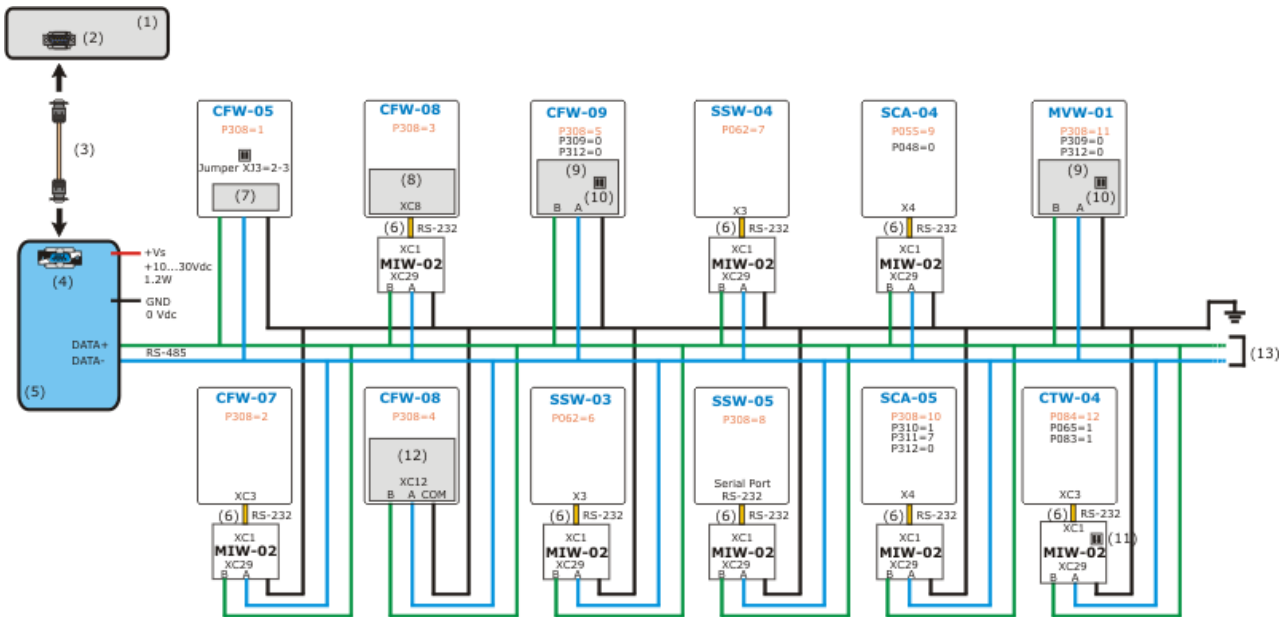

- (1) PC with SuperDrive software.
- (2) DB9 male connector (COM1...COM16).
- (3) RS232 serial cable for PC / RS232/RS485 converter connection.
- (4) DB9 female connector.
- (5) RS232/RS485 converter.
- (6) RS232 serial cable for MIW-02/Drive connection.
- (7) CEF2 board (optional).
- (8) RS232 serial Interface optional board.
- (9) EBA optional board (XC4 connector) or EBB (XC5 connector).
- (10) Use a terminating resistor when it is the last drive.
EBA board = terminating resistor S3, S3.1=ON and S3.2=ON.
EBB board = terminating resistor S7, S7.1=ON and S7.2=ON.
- (11) Use a terminating resistor when it is the last drive.
Terminating resistor S28, S28.1=ON e S28.2=ON.
- (12) RS485 Communication Module and Keypad.
- (13) Drives.

P.S.: the above figure can be found at directory/folder [Drive]:\WEG\SuperDrive 8.0.0.3041\Help\.

DRIVE CONFIGURATION OF THE NETWORK

To the network can be connected up to 30 drives. Each drive should have a different address between 1...30. Each drive has a parameter, where this address is selected:

- CFW-05, CFW-07, CFW-08, CFW-09, SSW-05, SCA-05, MVW-01: parameter 308.
- SSW-03, SSW-04: parameter 062.
- SCA-04: parameter 055.
- CTW-04: parameter 084.

RS232/RS485 CONVERTER

For a good system performance, it is recommended to use the following RS232/RS485 converters:

- Opto-isolated RS232/RS485 converter from Advantech Co., Ltd, model Adam-4520
- Opto-isolated RS232/RS485 converter from Black Box Corporation, model IC109A

For the RS485/RS232 conversion, it is suggested the use of the MIW-02 module. For more details about these products, please contact the manufacturer.

8.5 Adam 4520

Function: RS232/RS485 converter.

ADAM-4520 JUMPERS

SW1

1 = On

2 = Off

SW2

1 = Off

2 = Off

3 = Off

4 = Off

5 = On

6 = Off

7 = Off

8 = Off

9 = Off

10 = Off

RS232 SERIAL CABLE FOR PC/ADAM-4520 CONNECTION

A RS232 serial cable should be used for the connection of the RS232/RS485 converter to the PC.

Figure below shows the cable parts for this connection.

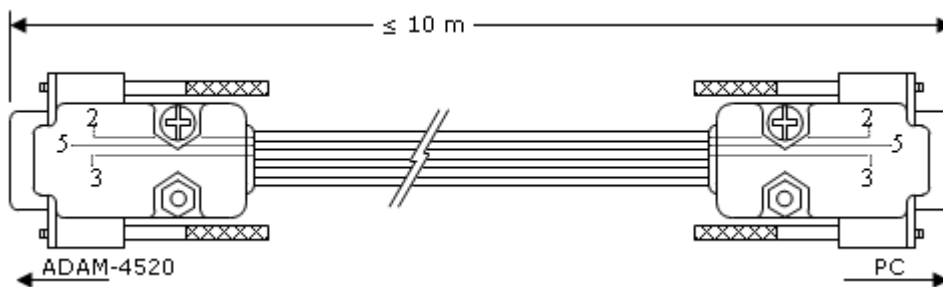

Length: 3 meters.

Maximum cable length: 10 meters.

8.6 IC109A

Función: conversor RS232/RS485.

CONNECTION

Figure below shows how to connect PC to the network of drives.

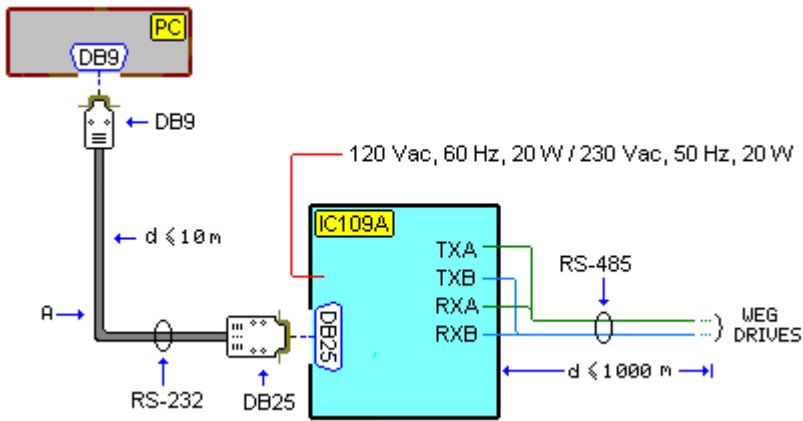

A - RS232 cable

RS232 CABLE

Connection between RS232/RS485 converter and PC must be realized by cable. Figure below shows this cable in a simplified manner.

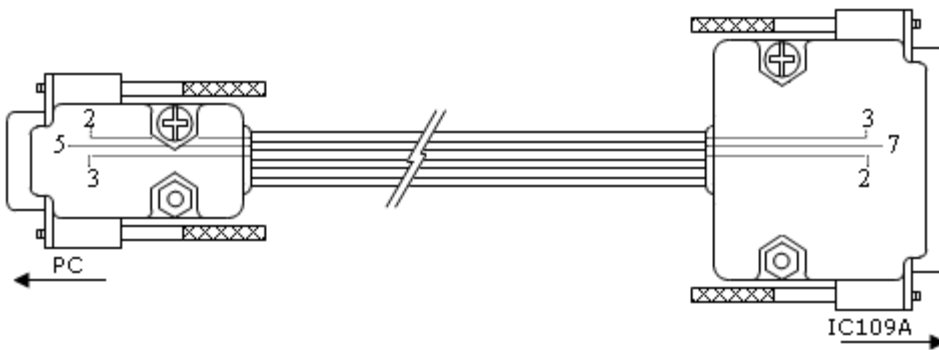

Flat cable with 6 connectors: only signal RXD, signal TXD and signal GND are updated.
 Female DB9 connector: PC side.
 Male DB25 connector: RS232/RS485 converter side.

JUMPERS IC109A

- XW1 = A
- W5 = A-B
- W7 = Out
- W8 = B-C
- W9 = C
- W15 = B-C
- W16 = A
- W17 = E
- S1 = Out (Normal)
- S2 = On (Term)
- S3 = On (Line Bias On)

8.7 MIW-02

INTERFACE MODULE FOR RS232/RS485 COMMUNICATION - MIW-02

Figure below shows MIW-02 connections.

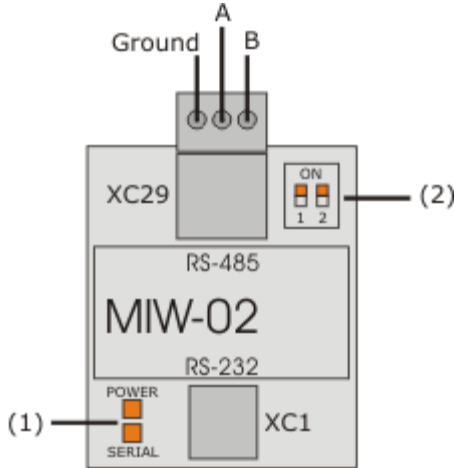

- (1) LEDs
- (2) Terminating Resistor

For further information see MIW-02 Interface Module Manual.

RS232 SERIAL CABLE FOR MIW-02/DRIVE CONNECTION

The user shall use a cable to connect the MIW-02 to the Drive.

Figure below shows the cable parts for MIW-02 / Drive connection.



8.8 Serial Communication Errors

During the serial communication many error messages can be displayed;

Every time a message is displayed suggesting abort, the user must do so. If the communication is not aborted, many other error can occur afterwards, what is not desirable.

In the same way, when user is informed about a serial communication error, he must end the operation that is running. If notwithstanding the user continues, many other errors can appear.

When the error not possible to write in the parameter is indicated, the user must check about the parameter functioning as described in the manual.

8.9 USB Serial Converter

The USB SERIAL converter is the best solution for the connection of serial equipment (RS232) to USB ports, i. e., for connecting computer USB output to a RS232 serial equipment.

This is a low cost solution and meets the install requirements of new computer serial ports that have busy bus bars or equipments (notebooks) that are not fitted with RS232 ports.

The USB Serial converter allows the plug & play connection with you computer, thus maintaining free the existing serial port.

PURCHASE SUGGESTIONS

Manufacturer: Comm5 Tecnologia

Product: Conversor de USB para 1 saída serial RS232

Model: 1S-USB - conversor USB para 1 serial

Web Site: <http://www.comm5.com.br/produtos/conversor-usb/1s-usb/>

For further information about product installation, please refer to user's manual.



Manufacturer: Tripp Lite

Product: USB High Speed Serial Adapter

Model: USA-19HS

Web Site: <http://www.tripplite.com/>

For further information about product installation, please consult USA-19HS user's manual.



9 Solving Problems

Contents of this chapter:

Printing Problem

Communication Problem

9.1 Printing Problem

The screen and the printing resolution are not frequently the same. Thus when you are printing, the results may be not the same as seen on the screen.

Thus, if general protection fault is shown when you are printing some topic, check the printer driver. If possible, change to a more updated version of the driver.

Assure that the printer is activated and that you can print from any application. If even thus the problem persists, open the property page of the printer that you are using. Select the properties that better matches your system.

9.2 Communication Problem

If SuperDrive does not communicate with the Drive

- Check if the serial cable is properly working and if you are using the correct cable model. Check if there is no disconnected wire on the cable, if the cable pinout is correct or if the cable is well connected.
- Check if you are using the correct drive address and if the project on SuperDrive indicates the same address. Also check if the drive communication protocol is correct (WEGBUS).
- Check equipment jumpers: see drive Manual.
- Check if the PC serial port (COM1...COM16) selected in the SuperDrive is the same where the cable is connected.
- Turned off drive, disconnect and connect the cable again, turn on the drive again.
- Interrupt request of Windows for the serial ports (COMxx) not correctly configured: check on control panel the item [Device Manager > Ports]. If possible, use default configurations. The window must show that there is no conflict with other devices.

COM1 Serial Port:
Interrupt request 04
Input/Output Range
03F8-03FF

COM2 Serial Port:
Interrupt request 03
Input/Output range
02F8-02FF

COM3 Serial Port:
Interrupt request 04
Input/Output range
03E8-03EF

COM4 Serial Port:
Interrupt request 03
Input/Output range
02E8-02EF

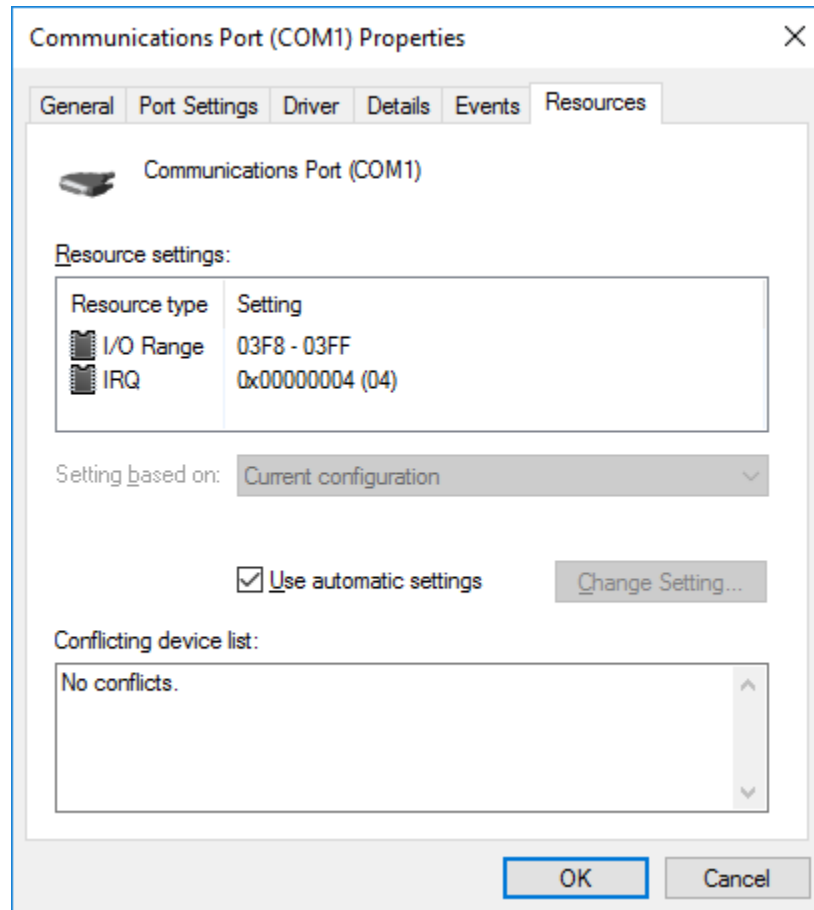

- Several computers may have serial communication problems when COM2 is used. When COM2 is used, check if this port is operating properly.
- Check if the serial port is in conflict with some other device that uses the same serial port. Serial ports of laptops may generate conflict with other devices, mainly with optical devices.
- Do not use the COM3 port if there is a serial mouse or any other device connected to COM1 port. Usually, COM1 and COM3 ports share the same IRQ and cannot be used simultaneously. It is also true for COM2 and COM4 ports. If possible, assign a different IRQ for COM3 and COM4 ports in order to solve the conflict.

Index

- A -

About SuperDrive 59
 Acquire Parameter 38
 Adam 4520 67
 Always Local Command 49
 Always Remote Command 50
 Application Data 28

- B -

Basic Application 48
 Before Installing SuperDrive 17

- C -

Close 24
 Communication Problem 72
 Communication Settings 47
 Control Setting Wizard 61
 Copyright Notice 14
 Customer Data 28

- D -

Drive Data 29
 Drive Parametrization 62
 DriveBar 26
 Drives Network 55

- E -

End User Data 29
 Error Log 46
 Exit 26

- H -

Help 58

- I -

IC109A 67
 Identify Drives 46
 Initial Power-up Wizard 61
 Installation/Uninstallation 17

Installing SuperDrive 17
 Introduction 7

- L -

Language 56
 License 59
 Local Command with Reference via HMI and 3-Wire Start/Stop 54
 Local/Remote Command with Selection via HMI 53

- M -

Macros 48
 Menus 22
 MIW-02 69
 Monitor Parameters 32
 Monitor Parameters using Modem 33
 Monitor Using Keypad 32
 Motor Data 29
 Multispeed with Commands via Digital Inputs 52

- N -

New 23

- O -

Offline 27
 Online 30
 Online Graph 41
 Open 23
 Options 57

- P -

Parameters 27
 Print 25
 Print Setup 25
 Printing Problem 72
 Project 23
 Project Architecture 20
 Protocol 63

- R -

Read Parameters 31
 Remove 24
 RS232 63
 RS485 65

- S -

- Safety Warning 59
- Save As 24
- Select Drive Address 30
- Self-Tuning Wizard 61
- Serial Communication 62
- Serial Communication Errors 69
- Solving Problems 72
- StatusBar 27
- SuperDrive 8.0.0.3041 6
- SuperDrive Architecture 19
- SuperDrive Structure 19
- Supported Drives 8
- System Requirements 7

- T -

- Technical Support 58
- ToolBar 26
- Tools 55
- Topics 58
- Trace Function 42

- U -

- Uninstalling SuperDrive 18
- Update Parameters to Other Firmware Version 55
- USB Serial Converter 70
- User's Manual - PDF 14

- V -

- View 26
- View Chart 40

- W -

- Welcome 7
- What's New 15
- What's New - Previous Versions 15
- What's New - This Version 15
- Wizards 61
- Write Parameters 31